



EUROPEAN COMMISSION

Brussels, 17.7.2012
SWD(2012) 200 final

VOLUME I

COMMISSION STAFF WORKING DOCUMENT

Impact assessment report on the revision of the “Clinical Trials Directive” 2001/20/EC

Accompanying the document

**Proposal for a Regulation of the European Parliament and of the Council
on clinical trials on medicinal products for human use, and repealing Directive
2001/20/EC**

{SWD(2012) 201 final}

{COM(2012) 369 final}

COMMISSION STAFF WORKING DOCUMENT

Impact assessment report on the revision of the “Clinical Trials Directive” 2001/20/EC

Accompanying the document

**Proposal for a Regulation of the European Parliament and of the Council
on clinical trials on medicinal products for human use, and repealing Directive
2001/20/EC**

Contents

1.	Procedural issues	7
1.1.	Consultations of other Commission departments and agencies	7
1.2.	Consultations of Member States	7
1.3.	Stakeholder consultations	7
1.4.	Contacts with non-EU authorities	9
1.5.	Impact Assessment Board	9
2.	Problem definition	10
2.1.	Introduction — setting the scene	10
2.1.1.	What are clinical trials?	10
2.1.2.	The regulation of clinical trials in the EU	13
2.1.3.	Affected bodies and enterprises – the "sponsor"	14
2.1.4.	The benefits of clinical trials – Public and patient health	14
2.2.	Problem identification	17
	Introduction	17
2.2.1.	Separate submission, diverging assessments and regulatory follow-up of applications for clinical trials	21
2.2.2.	Greater difficulties with conducting clinical trials due to regulatory requirements not adapted to practical considerations and needs	24
2.2.3.	Reliability of clinical trial data in a globalised research environment	26
2.3.	Union powers and subsidiarity	28
3.	Objectives	29
3.1.	Objective No 1: A modern regulatory framework for submission, assessment and regulatory follow-up	29
3.2.	Objective No 2: Regulatory requirements which are adapted to practical considerations, constraints and needs, without compromising the safety, well-being and rights of participants in clinical trials and without compromising data robustness	30
3.3.	Objective No 3: Addressing the global dimension of clinical trials when ensuring compliance with GCP	30
3.4.	Coherence with strategic policy objectives of the EU and the Commission	30
4.	Policy options	31
4.1.	Objective No 1 — A modern regulatory framework for submission, assessment and regulatory follow-up of applications for clinical trials	31
4.1.1.	Policy option No 1/1 — No action at Union level and reliance on voluntary cooperation of Member States (baseline option)	31
4.1.2.	Policy option No 1/2 — Single submission with separate assessment	32
4.1.3.	Policy option No 1/3 — Single submission with joint assessment by Member States of issues not related to ethical aspects	32
4.1.4.	Policy option No 1/4 — Single submission with central assessment by the Agency of issues not related to ethical aspects	34
4.1.5.	Policy option No 1/5 — Choice of legal form — Adopting the text of the Clinical Trials Directive in the form of a Regulation	35
4.1.6.	Policy option No 1/6 — Combination of policy option No 1/3 and No 1/5	35
4.2.	Objective No 2 — Regulatory requirements adapted to practical considerations and needs	35
4.2.1.	Policy option No 2/1 — No action at Union level (baseline option)	35
4.2.2.	Policy option No 2/2 — Enlarging the scope of non-interventional trials	35
4.2.3.	Policy option No 2/3 — Excluding ‘non-commercial sponsors’	36
4.2.4.	Policy option No 2/4 — Removing regulatory requirements on the basis of the knowledge of the IMP	36

4.2.5.	Policy option No 2/5 — Insurance/Optional ‘national indemnification mechanism’	37
4.2.6.	Policy option No 2/6 — Combination of policy option No 2/4 and No 2/5	38
4.3.	Objective No 3 — Addressing the global dimension of clinical trials when ensuring compliance with GCP.....	38
4.3.1.	Policy option No 3/1: Leaving the situation as it is (baseline option)	38
4.3.2.	Policy option No 3/2: Facilitating GCP inspections by increasing transparency	38
4.3.3.	Policy option No 3/3: Inspections of non-EU countries' regulatory systems for clinical trials	39
4.3.4.	Policy option No 3/4: GCP inspections of non-EU countries' clinical trial sites	39
4.3.5.	Policy option No 3/5 — Combination of policy option No 3/2 and No 3/3	39
5.	Impact of policy options.....	39
5.1.	Objective No 1 — A modern regulatory framework for submission, assessment and regulatory follow-up of applications for clinical trials.....	41
5.1.1.	Policy option No 1/1: No action at Union level and reliance on voluntary cooperation of Member States (baseline option).....	41
5.1.2.	Policy option No 1/2 — Single submission with separate assessment	44
5.1.3.	Policy option No 1/3 — Single submission with joint assessment by Member States of issues not related to ethical aspects	45
5.1.4.	Policy option No 1/4: Single submission with central assessment by the Agency of issues not related to ethics	48
5.1.5.	Policy option No 1/5 — Choice of legal form — Adopting the text of the Clinical Trials Directive in the form of a Regulation.....	51
5.1.6.	Policy option No 1/6 — Combination of policy option No 1/3 and No 1/5	52
5.1.7.	Comparison of policy options for objective No 1 and synergies	52
5.2.	Objective No 2 — Regulatory requirements adapted to practical considerations and needs	56
5.2.1.	Policy option No 2/1: No action at Union level (baseline option).....	56
5.2.2.	Policy option No 2/2 — Enlarging the scope of non-interventional trials.....	56
5.2.3.	Policy option No 2/3 — Excluding ‘non-commercial sponsors’	57
5.2.4.	Policy option No 2/4: Removing regulatory requirements on the basis of the knowledge of the IMP	58
5.2.5.	Policy option No 2/5 —Insurance/optional ‘national indemnification mechanism’	60
5.2.6.	Policy option No 2/6 — Combination of policy options No 2/4 and No 2/5... ..	61
5.2.7.	Comparison of policy options for objective No 2 and synergies	62
5.3.	Objective No 3: Addressing the global dimension of clinical trials when ensuring compliance with GCP.....	65
5.3.1.	Policy option No 3/1: Leaving the situation as it is (baseline option)	65
5.3.2.	Policy option No 3/2: Facilitating GCP inspections by increasing transparency	65
5.3.3.	Policy option No 3/3: Inspections of non-EU countries' regulatory systems for clinical trial.....	66
5.3.4.	Policy option No 3/4: GCP inspections of non-EU countries' clinical trial sites	66
5.3.5.	Policy option No 3/5: Combination of policy options No 3/2 and 3/3	67
5.3.6.	Comparison of policy options for objective No 3 and synergies, subsidiarity	67
6.	Conclusion — Final choices of policy options — Overview.....	69
6.1.	Final choices of policy options.....	69
6.2.	Final overview.....	70

7. Monitoring and evaluation	71
Annex 1: Clinical Trials and the Clinical Trials Directive.....	
Annex 2: Key figures	
Annex 3: Objective No 1 — A modern regulatory framework for submission, assessment and regulatory follow-up of applications for clinical trials.....	
Annex 4: Objective No 2 — Regulatory requirements adapted to practical considerations and needs.....	
Annex 5: Objective No 3 — Addressing the global dimension of clinical trials when ensuring compliance with GCP.....	
Annex 6: Costs and financing strategies for the single submission point.....	
Annex 7: Policy option 1/3: Support structure at EU level - implementation costs	
Annex 8: Involvement of Commission or Agency – Key points for consideration.....	

Acronyms

AESGP	<i>Association of European Self-medication Industry</i>
ASR	<i>Annual Safety Report</i>
CIOMS	<i>Council for International Organisations of Medical Sciences</i>
CoE	<i>Council of Europe</i>
CTFG	<i>Clinical Trials Facilitation Group</i>
EATG	<i>European Aids Treatment Group</i>
EC	<i>Ethics Committee</i>
ECPC	<i>European Cancer Patient Coalition</i>
EEA	<i>European Economic Area</i>
EFPIA	<i>European Federation of pharmaceutical industries and associations</i>
EPF	<i>European Patient's Forum</i>
EMA	<i>European Medicines Agency ('the Agency')</i>
EORTC	<i>European Organisation for Research and Treatment of Cancer</i>
EUCOPE	<i>European Confederation of Pharmaceutical Entrepreneurs</i>
EUCROF	<i>European Contract Research Organisation Federation</i>
EVCTM	<i>Eudravigilance – Clinical Trials Module</i>
FTE	<i>Full-Time Equivalent</i>
FVO	<i>Food and Veterinary Office of the European Commission</i>
GCP	<i>Good Clinical Practice</i>
IAB	<i>Impact Assessment Board</i>
ICH	<i>International Conference on Harmonisation of Technical Requirements for Registration of Pharmaceuticals for Human Use</i>
ICREL	<i>(Study on) 'Impact on Clinical Research of European Legislation'</i>
IMP	<i>Investigational Medicinal Product</i>
MAA	<i>Marketing Authorisation Application</i>
MHRA	<i>Medicines and Healthcare products Regulatory Agency of the UK</i>
NCA	<i>National Competent Authority</i>
OECD	<i>Organisation for Economic Cooperation and Development</i>
PIP	<i>Paediatrics Investigation Plan</i>
PSUR	<i>Periodic Safety Update Report</i>
SA	<i>Substantial Amendment</i>
SME	<i>Small and Medium-sized Enterprise</i>
SUSAR	<i>Suspected Unexpected Serious Adverse Reaction</i>
TFEU	<i>Treaty on the Functioning of the European Union</i>
VHP	<i>Voluntary Harmonised Procedure</i>

1. PROCEDURAL ISSUES

1. In its Communication of 10 December 2008 to the European Parliament, the Council, the European Economic and Social Committee and the Committee of the Regions on ‘Safe, Innovative and Accessible Medicines: a Renewed Vision for the Pharmaceutical Sector’,¹ (‘the 2008 Pharmaceuticals Communication’) the Commission announced that an assessment would be made of the working of Directive 2001/20/EC of the European Parliament and of the Council of 4 April 2001 on the approximation of the laws, regulations and administrative provisions of the Member States relating to the implementation of good clinical practice in the conduct of clinical trials on medicinal products for human use² (the ‘Clinical Trials Directive’).
2. This assessment would consider, in particular, various options for improving the functioning of the Clinical Trials Directive with a view to making legislative proposals, if appropriate, while taking the global dimension of clinical trials into account.
3. This impact assessment and adoption of the legislative proposal in 2012 are contained in the Commission work programme for 2011³ and 2012⁴ and are scheduled in the Commission’s ‘agenda planning’ under reference number 2011/SANCO/015.

1.1. 1.1. Consultations of other Commission departments and agencies

4. An Inter-Service Steering Group was set up which met on various occasions. The meetings were attended by representatives from Directorates-General ENTR, DEVCO, JUST, RTD, BUDG and the Secretariat-General. Close contacts were maintained with the European Medicines Agency (‘the Agency’) on this file.

1.2. 1.2. Consultations of Member States

5. The proposed revision of the Clinical Trials Directive was presented to and discussed by the Pharmaceutical Committee⁵ at its 66th (14 February 2011) and 67th (5 October 2011) meeting.
6. Various technical aspects of the impact assessment were discussed with Member States’ representatives at the meetings of the ‘Ad hoc group for the development of implementing guidelines for the ‘Clinical Trials Directive’ 2001/20/EC’⁶.

1.3. 1.3. Stakeholder consultations

7. In October 2007, the Commission, jointly with the Agency, held a one-day conference on ‘Operation of the Clinical Trials Directive (Directive 2001/20/EC)

¹ COM(2008) 666 final.

² OJ L 121, 1.5.2001, p. 34.

³ COM(2010) 623; see Annex II (point 20) and Annex III (point 41).

⁴ COM(2011) 777, see Annex I (point 54) and Annex II (point 10).

⁵ Established by Council Decision 75/320/EEC of 20 May 1975 setting up a pharmaceutical committee (OJ L 147, 9.6.1975, p. 23).

⁶ <http://ec.europa.eu/transparency/regexpert/detail.cfm?ref=1464>.

and Perspectives for the Future’ (hereinafter referred to as the ‘Commission/Agency clinical trials conference’). The results of that conference were published in an extensive report.⁷

8. The Commission held a stakeholder consultation from 9 October 2009 to 8 January 2010 on the basis of a public consultation document (hereinafter referred to as the ‘2009/10 public consultation’).
9. This stakeholder consultation was followed up by a public consultation on a concept paper concerning revision of the Clinical Trials Directive (hereinafter referred to as the ‘2011 public consultation’).⁸ This public consultation was open from 9 February to 13 May 2011.
10. Topics which had been explored extensively during the first consultation were not put forward again for discussion. Instead, the purpose of the 2011 public consultation was:
 - to seek more specific ideas on the issues that were presented in a rather general way during the 2009/10 public consultation. Consequently, some issues considered in the concept paper were of a more detailed and technical nature; and
 - to verify with stakeholders the core data which form the basis of the impact assessment.
11. Thus, the concept paper submitted in the 2011 public consultation was more detailed and specific. It presented:
 - a ‘preliminary appraisal’ of the options which appear to be the most suitable to address some of the key concerns of the Clinical Trials Directive, on the basis of the current state of the impact assessment; and
 - the main figures that are being used to evaluate the impact of the various policy options.
12. In both public consultations, all the ‘General principles and minimum standards for consultation of interested parties by the Commission’⁹ were met. The responses, and a summary of them, have been published by the Commission.¹⁰ In addition, the main results of the public consultations are taken up, grouped according to stakeholder groups, throughout this report. A general appraisal of the various stakeholder groups is contained in Annex 1.
13. In addition, the Commission held several meetings with stakeholders to hear their assessment of how the Clinical Trials Directive is working and to discuss the impact of potential policy options. A first round of meetings was held with stakeholder groups (patients, industry and academic researchers) in 2009. In the course of the 2011 public consultation a large stakeholder workshop was held on 31 March 2011 to clarify various points put forward in the concept paper. Moreover, this workshop gave stakeholders an opportunity to discuss their concerns together and to get to know each other’s views.

⁷ EMEA/565466/2007: http://www.eortc.be/services/doc/EUCTD/EC-EMEA_report_CT_20071003.pdf.

⁸ http://ec.europa.eu/health/files/clinicaltrials/concept_paper_02-2011.pdf.

⁹ COM(2002) 704.

¹⁰ http://ec.europa.eu/health/human-use/clinical-trials/index_en.htm.

14. Finally, both in the run-up to and throughout the impact assessment process, stakeholders launched several projects and published the results in several documents. They include:
- The recommendations of the High-Level Group of Independent Stakeholders on Administrative Burdens (‘Stoiber Group’) of 5 March 2009;¹¹
 - The ‘forward look’ by the European Science Foundation on ‘Investigator-driven clinical trials’,¹² published in March 2009;
 - The ‘Road Map Initiative for Clinical Research in Europe’ of the multi-stakeholder ‘European Forum for Good Clinical Practice’. In the context of this road map initiative a series of workshops were held which concluded with suggestions as to how to improve the legislation on clinical research;¹³
 - The project ‘PatientPartner — Identifying the Needs of Patients Partnering in Clinical Research’.¹⁴
15. Furthermore, the OECD has launched a working group in order to explore how to facilitate multinational cooperation in investigator-driven clinical trials.¹⁵
16. The Commission participated actively either in the projects themselves or in follow-up conferences and workshops.

1.4. 1.4. Contacts with non-EU authorities

17. In the course of the impact assessment, the Commission has been in close contact with the US Institute of Health. There have also been contacts with the authorities of several other non-EU countries (including Japan, China and India).

1.5. 1.5. Impact Assessment Board

18. The impact assessment was submitted to the Impact Assessment Board (IAB) for scrutiny.¹⁶ In its first opinion (which is publicly available on the EUROPA server¹⁷), the IAB requested the following improvements of the draft impact assessment report:

- Providing a clearer and more concise problem description, including a better presentation of stakeholder views, a presentation of the enterprises and research bodies primarily affected by the situation, concrete examples, and a discussion of the causality between the regulatory framework for clinical trials in the EU, and the decline of clinical trials conducted in Europe. Moreover, the IAB requested to

¹¹ http://ec.europa.eu/enterprise/policies/smart-regulation/files/hlg_opinion_pharma_050309_en.pdf. The recommendations are based on the ‘EU project on baseline and reduction of administrative costs — Measurement data and analysis for the pharmaceuticals legislation priority area’, Final report (March 2009) (http://ec.europa.eu/enterprise/policies/smart-regulation/files/abst09_pharma_en.pdf).

¹² http://www.esf.org/fileadmin/links/EMRC/FL_IDCT.pdf.

¹³

http://www.ebmt.org/2RelatedMeetings/EFGCP/Road%20Map%20Initiative%20for%20Clinical%20Research%20in%20Europe_Information.pdf.

¹⁴ <http://patientpartner-europe.eu/en/home>.

¹⁵ <http://www.oecd.org/dataoecd/31/8/49344626.pdf>.

¹⁶ http://ec.europa.eu/governance/impact/practice_en.htm.

¹⁷ http://ec.europa.eu/governance/impact/ia_carried_out/cia_2011_en.htm.

explain the relationship between medicines legislation and clinical trial regulation. These aspects have been addressed in section 2 of the report.

- Strengthening the 'intervention logic', by introducing operational objectives and better linking the policy options to them. Moreover the different policy options should be explained in more detail: This has been taken up in section 3 and in the presentation of the policy options in section 4 of the report.
 - Better presenting the impacts of the policy options, in particular by presenting stakeholder views on the policy options and by addressing combination of policy options separately and comparing them against the baseline. To address this, throughout section 5 of the report a short summary of stakeholder viewpoints, according to stakeholder groups, has been added.
 - Better explanation of monitoring and evaluation arrangements: This is addressed in section 7 of the report.
19. In its second opinion, the IAB requested the following improvements of the draft impact assessment report:
- A better link between the the problems experienced by sponsors and investigators, and the Clinical trials Directive. To address this, the report has been amended in sections 2 and 4.
 - A better explanation of the policy option No 2/5 ('national indemnification mechanism'). This has been addressed in the respective description of the policy option in section 5 of the report.
 - A clearer outline of the evaluation arrangements. This has been addressed in section 7 of the report.
20. Moreover, in its second opinion the IAB requested to shorten the report, for example by moving parts of the problem description into the Annexes. To respond to this request, the problem description has been shortened, and Annex 1 of the report has been amended.

2. PROBLEM DEFINITION

1.6. 2.1. Introduction — setting the scene

1.6.1. 2.1.1. What are clinical trials?

21. A clinical trial as defined in the Clinical Trials Directive is ‘any investigation in human subjects intended to discover or verify the clinical, pharmacological and/or other pharmacodynamic effects of one or more investigational medicinal product(s), and/or to identify any adverse reactions to one or more investigational medicinal product(s) and/or to study absorption, distribution, metabolism and excretion of one or more investigational medicinal product(s) with the object of ascertaining its (their) safety and/or efficacy’.¹⁸

¹⁸ Article 2(a) of the Clinical Trials Directive.

22. Clinical trials are performed in many different contexts: applications for marketing authorisation for medicinal products contain large amounts of data generated in clinical trials. Publications in medical journals are also often based on data generated in clinical trials. Therefore, clinical trials are an indispensable part of clinical research which, in turn, is essential to develop medicinal products and improve medical treatment. Without clinical trials, there would be no new medicines, no further development of existing medicines, and no evidence-based improvement of treatments with medicines.
23. In the EU/EEA,¹⁹ approximately 4400 clinical trials are applied for every year. This equals approximately 10000 applications in the Member States (one clinical trial can mean up to 27 clinical trial applications, see Annex 2, tables 2 and 3). Approximately 60% of clinical trials are sponsored²⁰ by the pharmaceutical industry and 40% by other stakeholders, such as academics.²¹ They aim to improve and optimise the use of authorised medicines, but could also well be done with the intention of developing a medicinal product. Detailed figures on clinical trials in the EU are given in Annex 2.
24. Approximately 24% of all clinical trials applied for in the EU are multinational clinical trials, i.e. clinical trials intended to be performed in at least two Member State. While this seems a relatively small proportion, it has to be highlighted that these 24% clinical trials involve approximately 67% of all subjects enrolled in a clinical trial.
25. This means that, in average, a clinical trial with more than 40 subjects is conducted in more than one Member State. Mono-national clinical trials are limited to small studies with low recruitment targets.
26. Having said this, multi-national clinical trials do not necessarily involve all Member States. Rather, in practice, multi-national clinical trials are only rarely being performed in more than 6-8 Member States. For example, in 2010, of the 4400 clinical trials applied for in the EU, only 268 (approximately 6%) were to be rolled out in eight Member States or more (see Annex 2).

¹⁹ For the purposes of this document, all references to the EU or EU Member States include the EEA or EEA Contracting States, unless indicated otherwise.

²⁰ The term 'sponsor' or 'sponsored' means the responsibility under which the clinical trial is conducted. It is not to be confused with 'funded' (a clinical trial might be funded by another body than the sponsor). See also Annex 1.

²¹ Source: EudraCT. When looking at clinical trial applications, the share of industry sponsors is 80% (one clinical trial can imply up to 27 applications, depending on the number of Member States concerned).

Chart: Share of multinational clinical trials applied for in the EU in 2010

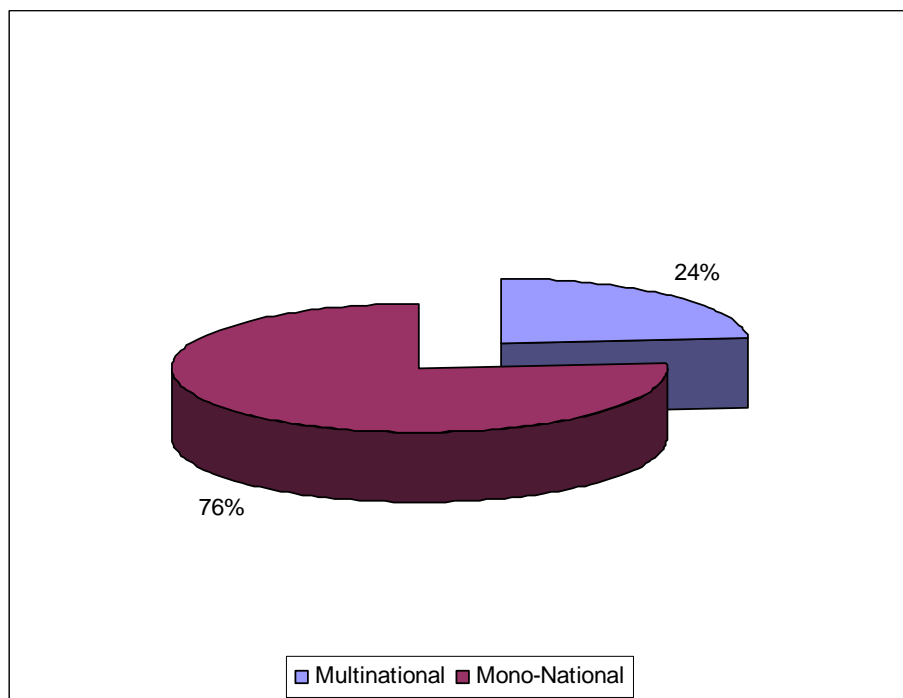
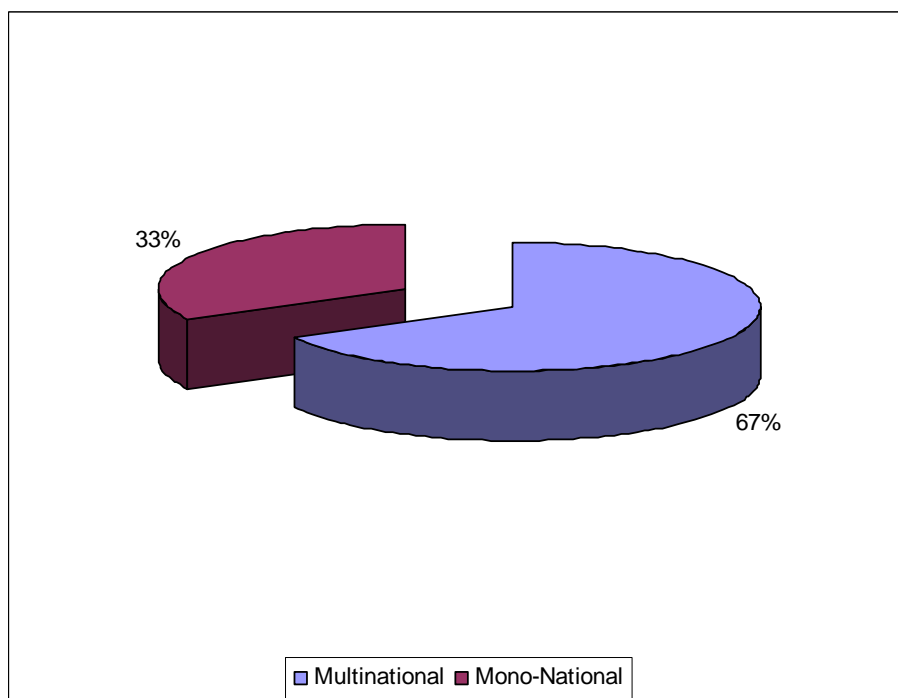

Chart: Share of subjects in multinational clinical trials applied for in the EU in 2010



27. The risk to safety of patients participating in a clinical trial depends on a variety of factors, in particular the extent of knowledge of the investigational medicinal product (IMP) and the type of intervention in the trial. At one end of the spectrum are ‘first-

in-man' (Phase I) clinical trials²² with compounds previously not administered to humans. At the other are clinical trials with well-known medicines which are used in the authorised indication, or one very similar, and where additional interventions do not go much beyond normal clinical practice (e.g. an additional blood sample or questionnaire). One example of these low-risk trials are large, randomised treatment optimisation studies, where authorised medicines are used in a clinical trial setting in order to improve standard therapies (see point 2.2.2).

1.1.1. The regulation of clinical trials in the EU

28. Clinical trials are regulated by the Clinical Trials Directive. The key aim of the Directive is compliance with good clinical practice (GCP). According to the Clinical Trials Directive, 'good clinical practice is a set of internationally recognised ethical and scientific quality requirements which must be observed for designing, conducting, recording and reporting clinical trials that involve the participation of human subjects. Compliance with this good practice provides assurance that the rights, safety and well-being of trial subjects are protected, and that the results of the clinical trials are credible.'²³ A description of the main contents of the Clinical Trials Directive is contained in Annex 1.
29. The conditions for conducting clinical trials, and in particular their authorisation, are unrelated to the regulation and authorisation of *medicinal products*:
- The Union *acquis* on medicinal products addresses the question whether and under what conditions a medicinal product *can be placed on the EU market*.
 - The aim of this legislation is to ensure that medicinal products placed on the market are of high quality as well as a favourable benefit-risk balance of the product. In this context, the Union *acquis* on medicinal products provides for various types of advice to (future) marketing authorisation holders as to what clinical data is desirable from the point of view of a marketing authorisation.
 - The Union *acquis* on clinical trials addresses the question *whether and under what conditions a clinical trial can be performed in the EU* (a clinical trial may be conducted with medicines already authorised (see point 2.1.1), or with medicines *not* yet authorised).
 - The aim of this legislation is to ensure the rights and safety of the subject, and to ensure that the data generated in a clinical trial is reliable and robust (for example, in view of statistical methods used, and in view of the endpoints measured). Thus, this legislation sets out what clinical trial is acceptable in view of the risk to subject rights and safety, and in view of the reliability and robustness of the data generated.
30. Thus, the authorisation of a medicinal product and the authorisation of a clinical trial follow different aims. These aims may even be in conflict: The conduct of a clinical trial may be desirable from the point of view of authorisation of a medicinal product, while from the point of view of the conduct of clinical trials, it cannot be authorised in view of subject rights and safety.

²² Information on the types of clinical trials is contained in Annex 1.

²³ Article 1(2). See also the Introduction to the ICH guidance on GCP.

31. The interface between the EU legislation on medicinal products and the EU legislation on clinical trials is limited to one aspect: the acceptability of clinical data in the marketing authorisation process. The clinical data submitted with a request for a marketing authorisation for a medicinal product in the EU has to stem from clinical trials conducted in accordance with the Clinical Trials Directive. If the clinical data stems from clinical trials conducted outside the EU, the clinical trial has to be conducted on the basis of principles which are equivalent to those applied in the Clinical Trials Directive.²⁴

1.1.2. Affected bodies and enterprises – the "sponsor"

32. The Clinical Trials Directive establishes the notion of 'sponsor', which is the person responsible for the clinical trial. Broadly speaking, two types of sponsors can be identified:

- Pharmaceutical companies ('industry sponsors'): These range from large multinational research-based pharmaceutical companies to small, research-based pharmaceutical companies (on the share of small and medium enterprises, see point 5).
- 'Non-commercial sponsors':²⁵ Although the term 'non-commercial sponsor' is not defined anywhere, it is generally understood to mean sponsors of clinical trials whose results are not intended to be used, *prima facie*, for authorisation or development of a medicinal product or for further extension of a medicinal product to other therapeutic areas. 'Non-commercial sponsors' are usually universities or academic institutes, foundations or charities. 'Non-commercial sponsors' range from large research organisations with well-organised structures to small, fragmented cooperative structures with a far lower level of dedicated resources.

33. These two types of sponsors are often interlinked: for example, research organisations may carry out clinical trials for pharmaceutical companies and academic research may, through publications, influence the development of medicinal products.

1.6.2. 2.1.4. The benefits of clinical trials – Public and patient health

34. The conduct of clinical trials is beneficial for innovation in public health and patient health, and brings about important investments into the healthcare sector.

Public health:

35. Clinical trials allow for improving public health in the EU and worldwide. Both the big advances and small, incremental improvements in public health in the last decades were possible largely thanks to clinical trials.

Example: ISIS-2 (the International Study of Infarct Survival) tested a new approach using aspirin and streptokinase in combination immediately after a heart attack. Use

²⁴ Point 8 of the introduction to Annex I of Directive 2001/83/EC.

²⁵ Sometimes referred to as 'academic sponsors'. Both terms are used interchangeably.

of either streptokinase or aspirin alone reduced the risk of vascular events by 25 per cent, but the two together decreased the risk by 50 per cent.²⁶

36. Apart from breakthrough studies like this, continuous advances in treatment have contributed to significant improvements in public health, not only in the EU but also worldwide. This progress was possible largely thanks to clinical trials. An example of this progress is the improvement in cancer survival rates in the EU over the last few decades.²⁷

²⁶ Medical Research Council, 'Trials that have changed the world' (<http://www.mrc.ac.uk/Achievementsimpact/Clinicaltrials/index.htm>).

²⁷ See also Arduino Verdecchia, Silvia Francisci, Hermann Brenner, Gemma Gatta, Andrea Micheli, Lucia Mangone, Ian Kunkler, and the EURO CARE-4 Working Group, Recent cancer survival in Europe: a 2000–02 period analysis of EURO CARE-4 data, *Lancet Oncol* 2007; 8: 784–96; Henrike E. Karim-Kosa, Esther de Vriese, Isabelle Soerjomataram Valery Lemmensa, Sabine Siesling, Jan Willem W. Coebergh, Recent trends of cancer in Europe: A combined approach of incidence, survival and mortality for 17 cancer sites since the 1990, *European Journal of Cancer*, 44 (2008)1345–1389.

Chart - Example: Survival rates of children and young adults suffering from cancer

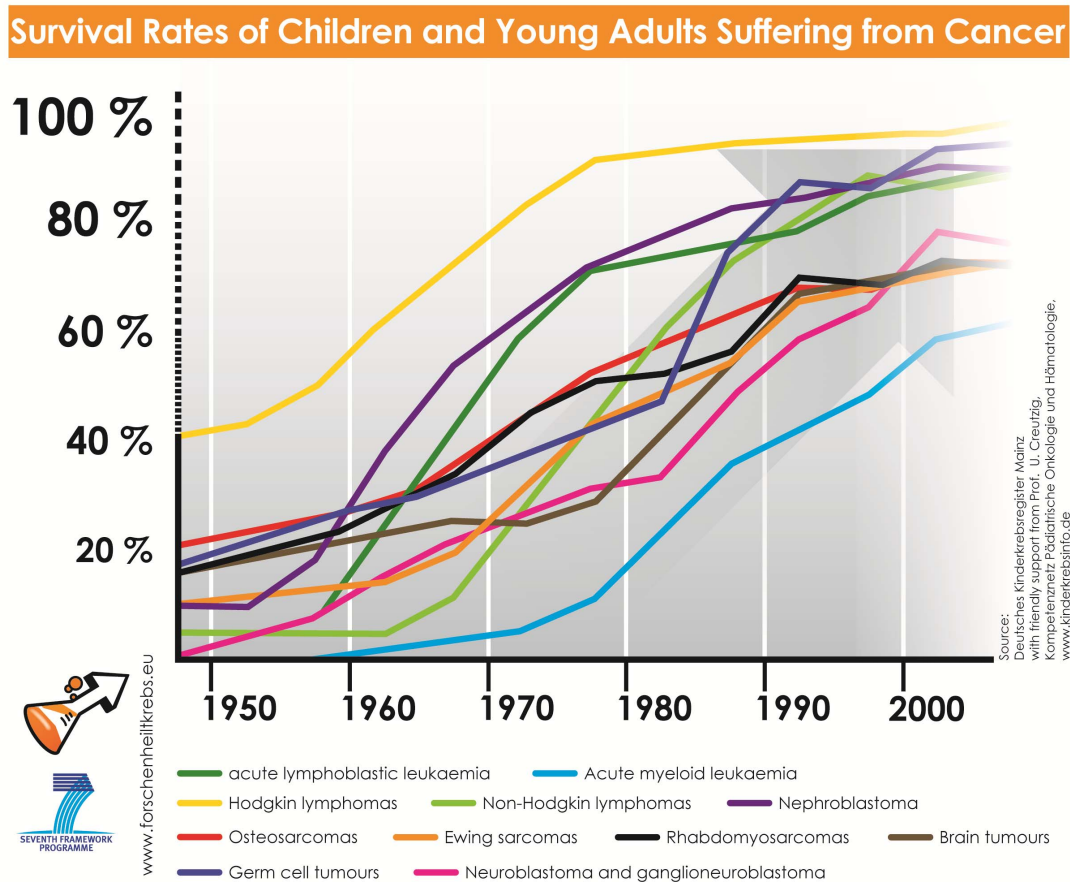

Patient health:

- 37. Apart from these societal benefits at large, clinical trials can be beneficial for patient health in the concrete setting of a clinical trial. Indeed, patients, in particular patients who suffer from serious or life-threatening diseases, are often keen to participate in clinical trials, as this may be the only way to access a treatment. The reasons why patient access to a medicine or to a medical treatment may only be possible through participation in a clinical trial are manifold: the medicinal product may not be available in a given Member State outside a clinical trial, or not be re-imbursed. Moreover, new medical treatments may not yet be widely spread and only be applied in the context of a clinical trial.
- 38. Therefore, patient organisations privately run 'clinical trial registries' in order to allow citizens to take part in research which may improve their conditions. Partly in order to respond to this urgent demand, the legislator has, in 2004, provided that information on clinical trials is to be made publicly available in the EudraPharm database.²⁸
- 39. Finally, while still much under debate, there are also studies suggesting that the participation in clinical trials is beneficial for the patient itself independently from

²⁸

<http://eudrapharm.eu/eudrapharm/welcome.do?selectedStaticLocale.languageCode=en>

whether the patient takes part in the 'experimental arm' or in the 'control arm' of a clinical trial.²⁹

Investments:

40. Conducting clinical trials entails considerable investment and growth in the EU, including inward investment by sponsors from non-EU countries (see Annex 2 for details). In recent years a range of publications have highlighted these tangible benefits of clinical trials.³⁰

1.7. 2.2. Problem identification

Introduction

41. The Clinical Trials Directive has brought about important improvements in the safety and ethical soundness of clinical trials in the EU and in the reliability of clinical trials data. This has been confirmed in numerous fora. For example, at the Commission/Agency clinical trials conference a large majority of the delegates acknowledged that, overall, the Directive had resulted in better protection of participants in clinical trials.³¹
42. Moreover, the Directive has led to cooperation in this area between Member States, who now meet regularly in three settings: the 'Ad hoc group on implementation of the 'Clinical Trials Directive' 2001/20/EC' (organised and chaired by the Commission), the inter-governmental 'Clinical Trials Facilitation Group' ('CTFG' - organised and chaired by Member States) and the 'GCP Inspectors Working Group' (organised and chaired by the Agency).
43. Nevertheless, the Clinical Trials Directive is **the most heavily criticised piece of legislation of the entire EU acquis for pharmaceuticals**. The criticism focuses on a too cumbersome and bureaucratic regulatory framework in the EU, which did not come along with a genuine harmonisation of administrative requirements. The severe criticism is voiced by all stakeholders and political actors - patients, industry, and academic research, Member States, Union institutions - and has been re-iterated and stressed during the various consultations referred to in point 1.3. Annex 1 sets out the broad criticism voiced by each of these actors and stakeholders:
44. The negative consequences of the fragmentation of the authorisation procedure were also highlighted by the High-Level Group of Independent Stakeholders on Administrative Burdens ('Stoiber Group') in its recommendations of 5 March 2009.³²

²⁹ The scientific findings diverge: See, for example Robinson WR, Ritter J, Rogers AS, Tedjarati S, Lieberenz C, Clinical trial participation is associated with improved outcome in women with ovarian cancer, *Int J Gynecol Cancer*. 2009 Jan;19(1):124-8; Vist GE, Bryant D, Somerville L, Birmingham T, Oxman AD. Outcomes of patients who participate in randomized controlled trials compared to similar patients receiving similar interventions who do not participate. *Cochrane Database of Systematic Reviews* 2008, Issue 3. Art. No.: MR000009. DOI: 10.1002/14651858.MR000009.pub4.

³⁰ See, for example 'Clinical Trials in Poland' PriceWaterhouseCoopers, November 2010 (<http://www.pwc.com/gx/en/pharma-life-sciences/publications/clinical-trials-in-poland-2010.jhtml>).

³¹ Report of the Commission/Agency clinical trial conference, p. 26.

³² http://ec.europa.eu/enterprise/admin-burdens-reduction/highlevelgroup_en.htm.

45. These criticisms are supported by the data available:
46. Decrease in the number of applications for clinical trials: According to the official EU-database for clinical trials (EudraCT), since 2007 the number of clinical trials applied for in the EU has fallen by 12% to 4 400 clinical trials applied for in 2010.

Chart: Clinical trials applied for in the EU³³

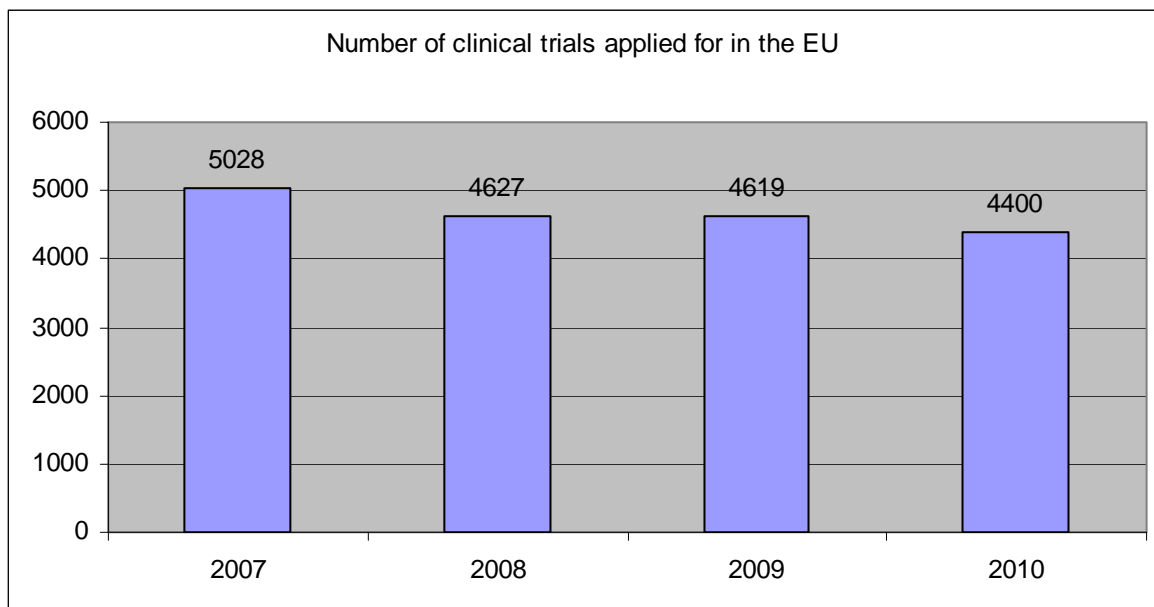

47. Increased costs for conducting clinical trials: In order to do a retrospective assessment of the effects of the Clinical Trials Directive, the Commission launched in 2008 a comprehensive study on the ‘Impact on Clinical Research of European Legislation’ (ICREL)³⁴ as part of the 7th Framework Programme. ICREL showed the following:
- Compared to the situation prior to the application of the Clinical Trials Directive, the staff needs for industry sponsors to handle the clinical trial authorisation process have doubled (107%); Small companies faced an even stronger increase. In some areas of clinical trial regulation, such as safety reporting, the number of FTEs in pharmaceutical companies increased by 85%;³⁵
 - Regarding non-commercial sponsors the increase of administrative requirements due to the Clinical Trials Directive has led to an increase of costs in administration of 98%;³⁶
 - Since implementation of the Clinical Trials Directive the insurance fees have dramatically increased for industry sponsors by 800%.³⁷

³³ EudraCT.

³⁴ ICREL was a longitudinal, retrospective, observational and comparative study to assess the impact of the Directive on the number, size and nature of clinical trials and on workload, resources required, costs and performance. Mean differences between 2003 (i.e. before the Clinical Trials Directive entered into force) and 2007 were assessed. Fuller details of the findings of the study can be obtained from: <http://www.efgcp.be/icrel/>.

³⁵ ICREL, p. 130.

³⁶ ICREL, p. 144.

48. Delays for launching a clinical trial: the average delay between finalisation of the protocol and the ‘first patient in’ has increased by 90% to 152 days³⁸.
49. The ICREL findings are similar to data published in numerous articles: In Hearn and colleagues³⁹ the authors investigated the impact of the Clinical Trials Directive on eight clinical trials units in UK. Results show that costs have doubled, the start of the trials was delayed and starting and conducting trials was much more difficult than before. As for the clinical research activity, Moulton⁴⁰ reported a decrease of 25% in submissions in Sweden; 40% in Ireland with a drop of 60% from non-commercial sponsors. The same was found by the Cancer Research UK where the number of clinical trial applications was down by approximately 50%. The European Organisation for Research and Treatment of Cancer (EORTC)⁴¹ faced the same situation: from 23 new studies in 2003 to 10 in 2007.
50. Despite this data one has to assess whether the decline is really caused by the Clinical Trials Directive, or by other causes than regulation. An assessment of possible other causes reveals, however, that the Clinical Trials Directive is an important direct or indirect driver of the numbers of clinical trials in the EU.
51. The following factors may contribute to the decline clinical trials in the EU:
- Industry conducts, generally, less research: The economic slowdown in Europe since 2009/10 might be considered as a cause for reduced clinical trials activity in the EU. However, nothing indicates that the pharmaceutical industry, overall, conducts less research than before: On the contrary, the constant increase of the amount of data requested in the context of a marketing authorisation (see point 2.2.1.4) leads, overall, to more research conducted by pharmaceutical companies themselves, or on their behalf. However, there is a general assumption that clinical research is increasingly conducted outside the EU (see below under this point).
 - Less public funding available: Regarding non-industry research, one may argue that, in view of the macroeconomic climate in Europe since 2010, there is less public funding available for conducting academic research. Even if this was the case, however, the effect of these cuts would not yet be reflected in the figures above.
 - More difficulties to recruit patients: Increasingly narrowly-defined disease profiles (see point 2.2.1.3) have made it more challenging to recruit patients. In practice, therefore, today, every larger clinical trial takes place in more than one Member State (see point 2.1.1). However, it is precisely these clinical trials that are particularly challenging in terms of clinical trials regulation in the EU (see point 2.2.1).

³⁷ ICREL, p. 132; See also point 2.2.2.

³⁸ ICREL, p. 128.

³⁹ Hearn J, Sullivan R, The impact of the ‘Clinical Trials’ directive on the cost and conduct of non-commercial cancer trials in the UK. Eur. J. Cancer 43:8-13, 2007.

⁴⁰ Moulton B, Two years later: the impact of the EU CTD. Why research in Europe has declined since the implementation of the Clinical Trials Directive. Applied Clinical Trials. August 1, 2006.

⁴¹ van Vyve D, Meunier F, Facing the Challenges of the European Clinical Trials Directive: the European Organisation for Research and Treatment of Cancer perspective, European Oncology, 2008; 4; 1.

- Increasing costs in terms of salaries, hospital service fees, etc.: One may argue that the increased costs for staff in the health sector makes it more difficult to conduct clinical trials in the EU. However, as far as clinical research is concerned, these costs are to a considerable extent influenced by regulatory requirements, and in particular the Clinical Trials Directive (see baseline option).
52. In conclusion, it would be wrong to attribute the decline of clinical trial activity solely and exclusively to the Clinical Trials Directive. However, the Clinical Trials Directive has had many direct effects on costs and feasibility of conducting clinical trials which, in turn, lead to a decline of clinical trial activity in the EU. Moreover, other causes (such as salary costs and the need to conduct multinational studies in order to reach recruitment targets) are aggravated through regulatory requirements and consequential costs of the Clinical Trials Directive.
53. This raises the question whether the Clinical Trials Directive has simply "stopped" clinical trials, or whether such research is taken to non-EU countries. In this respect, a distinction has to be drawn between industry sponsors and non-commercial sponsors:
- Regarding industry sponsors, there is a trend towards globalisation of the conduct of clinical trials which are increasingly conducted in emerging economies such as India, China and various South American states, as well as Russia.⁴² Various studies, as well as the media,⁴³ have highlighted a "dramatic shift"⁴⁴ in the location of trials from the traditional trial regions (North America and Europe) to new, emerging economies in the last years. While there is no ultimate proof available for the causality, all available sources suggest that, indeed, the reduced attractiveness of the 'traditional' trial countries in terms of costs contribute to the globalisation of the conduct of clinical trials. This effect has been highlighted in a number of scientific publications, and in both public consultations conducted by the Commission. For example, the Belgian pharmaceutical industry association 'Pharma.be' stressed that *"The emerging countries are attracting a growing number of large-scale clinical trials as they have access to large patient populations required to run these trials. [...] This shift to the 'rest of the world' has increased markedly in recent years and the trend looks set to continue, ultimately leading to a drop in clinical research activities in EU and US. [...] Creating a regulatory framework that favours the conduct of clinical trials at EU level should by all means be reinforced to keep clinical research in Europe."*⁴⁵
 - Regarding non-commercial sponsors, the situation is different as these actors usually do not have access to the globalised clinical trial market. In the case of non-commercial sponsors, if the regulatory and other impediments are too high, these clinical trials are simply not being performed.

⁴² For an overview of the non-EU regions involved today in pivotal clinical trials submitted at EU level for marketing authorisation purposes, see Table 14 in Annex 2.

⁴³ See, for example, 'Durg testing goes offshore' (CNNMoney, 8 August 2005) quoting various industry sources.

⁴⁴ S. W. Glickman, *et. al.*, Ethical and Scientific Implications of the Globalization of Clinical Research, *N Engl J Med* 360; 8 February 19, 2009, p. 816.

⁴⁵ Response to the 2011 public consultation, cover letter, page 2.

54. The concrete problems which are thus to be addressed are the following:

1.1.3. Separate submission, diverging assessments and regulatory follow-up of applications for clinical trials

1.7.1.1. 2.2.1.1. The issue

55. The Clinical Trials Directive provides that a clinical trial, prior to it being conducted has to be authorised by two distinct bodies: the national competent authority (NCA) and one or more Ethics Committee(s) (EC).⁴⁶ The "authorisation"⁴⁷ consists of two steps, the "submission" and the "assessment" (with a subsequent decision). In the assessment stage, the documentation in relation to the clinical trial is assessed in order to check compliance with the regulatory requirements of the Clinical Trials Directive (for more details on these requirements, see Annex 1). The various aspects are being checked either by the NCA, or by the EC, or by both, depending on national practices and traditions.

56. The delay for authorising a clinical trial is, according to the Clinical Trials Directive, 60 days, subject to some exceptions.⁴⁸

57. In addition, clinical trials are subject to regulatory follow-up/supervision. This includes any subsequent changes to the clinical trial ('substantial amendments' — SA), safety information, end-of-trial declarations, etc.

58. The submission, assessment and regulatory follow-up for the *same* clinical trial are conducted in the different Member States completely separately from one another. Thus, while the Clinical Trials Directive introduces a submission/assessment/authorisation process, it does not provide for any kind of cooperation or exchange of information. Neither does the Clinical Trials Directive give, in this process, any role to the Commission or to the Agency,⁴⁹ i.e. the entire process of submission, assessment and follow-up is conducted without any involvement of Union institutions or bodies.

59. The authorisation process for clinical trial, introduced in the EU with the Clinical Trials Directive, has been a key criticism of all stakeholders in the last years. This criticism has been voiced since the adoption of the Clinical Trials Directive. It has been highlighted in particular in the Commission/Agency clinical trials conference,⁵⁰ in the 2009/10 public consultation, where in particular the negative effect on SMEs was stressed.⁵¹ The delays of the actual full launch of the trial and increase in costs as established with ICREL (see points 2.2 and 2.2.1.2) are to a large extent attributed to the current system of submission, assessment and regulatory follow-up of clinical trials.

Chart: Submission/assessment procedure today (example: four Member States)

⁴⁶ Articles 6, 9 of the Clinical Trials Directive.

⁴⁷ In the context of ECs, the Clinical Trials directive uses the term 'favourable opinion'.

⁴⁸ Article 6(5) and Article 9(4) of the Clinical Trials Directive.

⁴⁹ The role of the Agency is limited to maintaining the EU clinical trials database EudraCT, and coordinating GCP inspection activity in the centralised authorisation procedure for medicines.

⁵⁰ See for example the Conference report, section 3.2.2: "*The burden of paperwork should be reduced by rationalising the application forms and the content of dossiers and by reducing the number of times the same or nearly the same information has to be submitted to different NCAs and ethics committees.*"

⁵¹ See point 2.2.

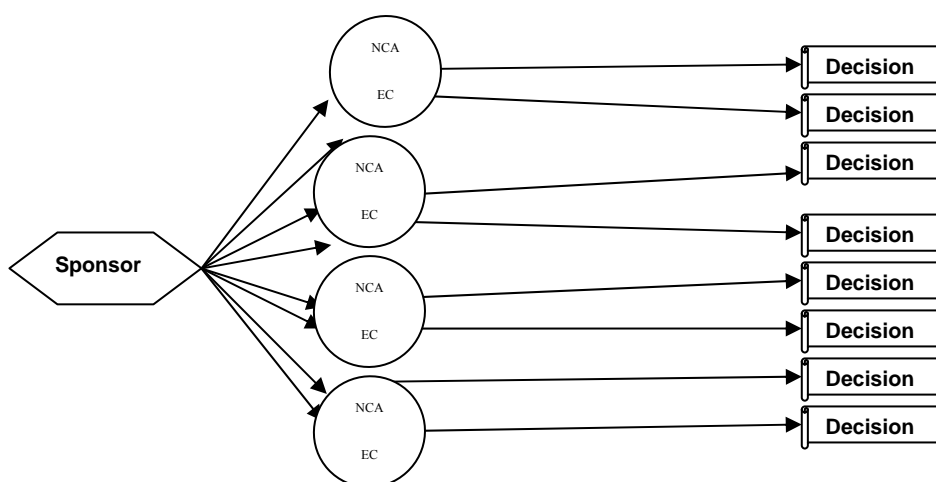

Separate submissions

60. For any clinical trial, the information required for the authorisation is submitted to each Member State separately. Moreover, usually, within each Member State the information is submitted to the two assessment bodies, the NCA and the EC, separately.

Separate assessments

61. As mentioned earlier, each clinical trial is subject to an assessment by two distinct bodies, the NCA and the EC of each Member State concerned. The scope of their assessments differs in each Member State, depending on national traditions and expertise. This renders even voluntary cooperation between Member States more difficult and further complicates authorisation of clinical trials in the Union. Furthermore, the requirements set out in the Directive for the assessment are applied very differently in the individual Member States concerned
62. In this context, it must be stressed that while the *outcome* of the assessment (i.e. clinical trial is approved or not) usually does not differ⁵², there are many differing, and sometimes conflicting, requests for additional information or national changes to a protocol.⁵³
63. In the 2011 public consultation it was confirmed that in approximately 80% of all multinational clinical trials, the feedback from the NCAs diverges as regards:
- requests for additional information; or
 - Grounds for non-acceptance.⁵⁴

⁵² See for example the response of the Association of Clinical Research Organizations (ACRO) to the 2009/10 public consultation (p. 2): "*The different application of the regulatory framework by Member States does not, in the majority of cases, lead to divergent decisions on clinical trial applications. However, prior to reaching the final decision, the questions raised by the national competent authorities on the identical scientific dossier are frequently very different in both number and nature and indicate a significantly divergent approach to dossier assessment.*"

⁵³ See, for example, the response from The European Clinical Research Organisation Federation in the 2009/10 public consultation (p. 3): "*Almost for every international study the list of deficiencies for the Investigational Medicinal Product Dossier varies considerably between the different national competent authorities involved.*"

⁵⁴ This figure is based on responses to the 2009/10 public consultation and has been double-checked in the 2011 public consultation (see page 22 of the public consultation document).

Separate regulatory follow-up/supervision

64. The difficulties are also echoed throughout the entire regulatory follow-up of a clinical trial. This includes any subsequent important changes to the clinical trial ('substantial amendments' — SA), safety information, end-of-trial declarations, etc.
65. In particular, concerning SAs, any change to the documentation submitted which is 'substantial' is subject to approval by each Member State individually. Within each Member State this is given either by the NCA or by the EC or by both. Again, this creates divergences in the regulatory assessment of a clinical trial. The difficulties described above with 'separate assessment' are repeated.

1.7.1.2. 2.2.1.2. Consequences

- Costs: The administrative burden and administrative costs for sponsors increase, without any added value: in both public consultations stakeholders submitted concrete evidence through examples that resources are moved from research to bureaucracy. For example, it was reported that, for a single clinical trial with 280 participating clinical trial sites, 100.000 copied pages of documents had to be submitted to various authorisation bodies. In another study, 12.000 pages of documents had to be provided for a study conducted at 13 trial sites.⁵⁵ This is a direct result of the concept of 'separate submissions' referred to under point 2.2.1.1.
 - Delays: The actual full launch of a clinical trial is delayed. As set out above (point 2.2.1.1), assessments of a clinical trial application very rarely conclude with simple "go"/"no-go": rather, the assessment concludes with additional questions, comments or conditions. These come in, from the various Member States concerned, at different time points and require adjustments to the planned clinical trial. In order to ensure data reliability and robustness, however, the sponsor is forced to maintain, as far as possible, one protocol. This leads to constant updates, amendments and changes of the documentation in different Member States during the assessment phase or right thereafter before a clinical trial can be rolled out. This "chain reaction"⁵⁶ was frequently highlighted in the 2009/10 public consultation⁵⁷ as a key cause for the long delays of the actual start of the trial as evidenced in the ICREL study (see point 2.2).
66. Exclusion of Member States: Divergencies in the assessments can lead to contradictory decisions on the requirements for the same clinical trial. As a result, sponsors decide not to perform the clinical trial in a given Member State. This point was highlighted in the 2009/10 public consultation.⁵⁸ This means that access to

⁵⁵ Response of ECPC in the 2009/10 public consultation, p. 5.

⁵⁶ Response of EFPIA in the 2009/10 public consultation, p. 4.

⁵⁷ Response of Roche in the 2009/10 public consultation (p. 3): "*Thus even simple adjustments needed based on local requests from one country results into amendments of the application in other countries where the clinical trial application is already approved.*"

⁵⁸ For example the European Federation of Pharmaceutical Industries and Associations (EFPIA) stressed, in its response to the 2009/10 public consultation (p. 3): "*Experience of multi-country studies is that it is very unusual not to receive idvergent assessments and that these do lead to different requested changes in the protocol. This may lead either to a trial not being run in the Member State or to having to make multiple amendments to the protocol thereby delaying access to treatment for patients and increase in administrative burden and costs.*"

innovative, potentially life-saving, treatment is denied to patients in one Member State to the advantage of those in another.

67. The detailed assessment of the consequences is set out in detail in the description of the ‘baseline’ below (policy option No 1/1 — no action at EU level).

1.7.1.3. 2.2.1.3. Link with the Clinical Trials Directive

68. The consequences set out under point 2.2.1.2 are a direct consequence of the Clinical Trials Directive: This Directive introduced a multiple submission/assessment process for mono-national as well as multi-national clinical trials. At the same time, the Clinical Trials Directive did not introduce any form of cooperation or coordination in these multiple assessments.

1.7.1.4. 2.2.1.4. Outlook

69. The responses in both public consultations highlighted that the problems described, and the consequences, are going to worsen in the future. While, today, approximately 25% of all clinical trials are being performed in more than one Member State, this share is going to increase further in the future due to the following developments:

- Diseases are increasingly narrowly defined and often linked to genetic characteristics of the subject (often described as the trend towards ‘personalised medicines’). In order to recruit sufficient subjects with these specific characteristics, sponsors have to roll out the clinical trial in several Member States. This holds particularly true for research into oncology;
- Increasingly, there is a need for research on specific patient populations, such as children, adolescents or the elderly. In practice it is sometimes difficult to recruit enough subjects from such specific patient populations. In order to meet recruitment targets, it is necessary to run multinational trials;
- The requirements and expectations of regulators and the research community for well-powered trials are constantly increasing. In order to power a clinical trial sufficiently, it has to be rolled out in several Member States.

1.1.4. Greater difficulties with conducting clinical trials due to regulatory requirements not adapted to practical considerations and needs

70. Regulation of clinical trials addresses two distinct risks: the risk to patient safety and the risk to data reliability. The former can vary widely, depending on a range of factors, in particular:

- The extent of knowledge and prior experience with the IMP (in particular, whether or not the IMP is already authorised in the EU or elsewhere); and
- The type of intervention (which can range from a simple blood sample to a sophisticated biopsy).

71. However, the Clinical Trials Directive does not sufficiently address these differences in risk and take them into account. Instead, the obligations and restrictions laid down in the Directive apply largely irrespectively of the risk to subject safety and without matching practical considerations and requirements.

Example: A clinical trial comparing the efficacy of two authorised medicines (A) and (B), which are both used in their authorised indication. There is no certainty about the best treatment choice. The additional intervention is limited to randomisation of the patients (some receive medicine A; others receive medicine B), and to an additional standard intervention (e.g. additional measurements of blood pressure). Considering that the patient would have received medicine A or medicine B anyway, this clinical trial poses no additional risk compared to normal clinical practice.

72. The disproportionate burden imposed by the Clinical Trials Directive is most obvious in the case of two key regulatory requirements in the Directive:

- Obligatory insurance/indemnity: Under the Clinical Trials Directive, the liability of the investigator or sponsor for possible injury or death of a participant in the clinical trial has to be covered by insurance or indemnity.⁵⁹ Thus, the Clinical Trials Directive has provoked the following situation:
 - Insurance/indemnity is obligatory, i.e. sponsors/investigators are forced to obtain insurance coverage on the insurance market;
 - This obligation applies to a small market: There are, at any given moment, approximately 12000 clinical trials ongoing in the EU. This is a very small segment in the insurance market for liabilities, in particular when comparing with other segments such as general liability insurance or automobile insurance.

The combination of a small market and an obligatory insurance (introduced with the Clinical Trials Directive) is the cause for a strong increase of the costs for premiums. ICREL has shown that, since implementation of the Clinical Trials Directive, the insurance premiums have increased for industry sponsors by 800%⁶⁰ even though justified claims continued to be very rare and the compensation payments low. This 'aberrantly expensive'⁶¹ insurance/indemnification coverage creates a disincentive to conduct clinical trials in the EU. This is discussed in more detail in the baseline option below (point 5.2.1.2).

- Obligatory annual safety report in the context of pharmacovigilance: Under the Clinical Trials Directive, every year the sponsor has to draft an 'annual safety report' (ASR) for every clinical trial.⁶² The annual safety report has an equivalent for medicines which are authorised and used outside the context of a clinical trial: the 'periodic safety update report' (PSUR). The ASR creates considerable costs for sponsors. The actual costs are presented in the baseline option below (point 5.2.1).

⁵⁹ Article 3(2)(f) of Directive 2001/20/EC. While the terms 'insurance' and 'indemnity' are not defined in the Clinical Trials Directive, for the purpose of this impact assessment they are to be understood as follows: 'Indemnity' is a broad concept entailing all mechanisms that are intended to compensate damages suffered by the damaged party. 'Insurance' is, more specifically, a mechanism whereby a third person guarantees payment of a compensation which is to be paid by the damaging party to the damaged party.

⁶⁰ ICREL, p. 132.

⁶¹ Response of the *Institut national de la santé et de la recherche médicale* to the 2011 public consultation, p. 11.

⁶² Article 17(2) of Directive 2001/20/EC.

73. Both obligations apply independently of the actual risk which a clinical trial poses to the subjects. However, as mentioned above, these risks differ widely.
74. This undifferentiated approach to regulation in the Clinical Trials Directive has been a key criticism of all stakeholders since the adoption of the Clinical Trials Directive in 2001. It has been a particular criticism of 'non-commercial sponsors' (see below). This criticism has been highlighted in the Commission/Agency clinical trials conference.⁶³ It was also stressed in both the 2009/10 and the 2011 public consultations, as well as in academic publications,⁶⁴ where stakeholders highlighted these as a heavy, and in many cases disproportionate, burden with associated increase in costs (including administrative burdens). Indeed, the increase in costs for administrative requirements as established with ICREL (see point 2.2) is – apart from the authorisation process - to a large extent attributed to the administrative requirements in the Clinical Trials Directive which are not proportionate to the additional risk to a patient posed by a clinical trial.
75. The issue set out in this problem description is critical in particular for 'non-commercial sponsors' (see point 2.1.2) which have greater difficulties than industry sponsors to comply with the obligations set out in the Clinical Trials Directive in terms of budgetary and human resources. Indeed, practically all non-commercial sponsors have, since the adoption of the Clinical Trials Directive, heavily criticised this new regulatory framework for having hampered the conduct of clinical. In particular, the new regulatory requirements were heavily criticised. It was stressed that non-commercial sponsors could not comply with these requirements in view of the limited financial and human resources for compliance with regulatory requirements.
76. In addition, it is noteworthy that this problem is also voiced by patients and patient groups, i.e. the stakeholders in whose interest clinical trials are actually regulated. This can be explained with patients' awareness of the benefits of clinical trials for evidence-based improvements of treatments, and possibly the benefits for individual patients participating in the trial (see point 2.1.4).

1.1.5. Reliability of clinical trial data in a globalised research environment

77. Clinical trials are performed in the EU and in non-EU countries. About 25% of all clinical trials performed in the EU also involve at least one non-EU country.
78. As regards clinical trial data submitted in EU-wide marketing authorisation, 65% of all data on patients submitted in pivotal clinical studies are generated in non-EU countries (see Annex 2).
79. This trend towards globalisation of clinical research is expected to increase further in the next years.⁶⁵

⁶³ See for example the conference report, section 3.10.2 ('Final discussions and perspectives for the future – Non commercial sponsors'): 'A new legal framework should protecti participants according to the risk associated to the category of study, not to the study's commercial or non-commercial objective.'

⁶⁴ Neaton JD, Babiker A, Bohnhorst M, Darbyshire J, Denning E, Frishman A, Grarup J, Larson G, Lundgren J., Regulatory impediments jeopardizing the conduct of clinical trials in Europe funded by the National Institutes of Health, Clin Trials. 2010 Dec;7(6):705-18. Epub 2010 Aug 20.

⁶⁵ See point 1.7.

80. Globalisation of clinical research, including in low-income non-EU countries, is by no means negative. Clinical research on a global scale is of benefit to the countries participating, to their populations and to global public health.
81. However, despite universal agreement on the applicable principles of GCP (see Annex 1), the globalisation of clinical research poses a challenge when it comes to **supervision of compliance** with GCP. Any clinical trial which is referred to in the EU in the context of another clinical trial or of an application for marketing authorisation has to comply with GCP if it is to be considered reliable. In the case of data submitted in an application for marketing authorisation, Union legislation requires that clinical trials performed in non-EU countries have to be conducted on the basis of principles which are equivalent to those applied in the Clinical Trials Directive.⁶⁶ This may be checked, in the framework of a marketing authorisation procedure, by the Agency (or national competent authorities) through inspections. These inspections may be conducted at any relevant site, such as the clinical trial site, or the sponsor site. In the case of a marketing authorisation procedure at EU-level, the Agency does not dispose over inspection capacities itself. Rather, these inspection capacities are provided voluntarily by NCAs.
82. In this context, it has to be stressed that there are, to date, no reliable, quantifiable data on whether the degree of non-compliance with GCP is higher in non-EU countries than in the EU. In particular, while the number of GCP inspections by the EU in non-EU countries is low and the sample size very limited (see Annex 2), the findings in these EU inspections in sites in non-EU countries do not differ significantly from GCP inspections conducted within the EU.
83. However, this matter is widely discussed in regulatory and political settings. For example, since 2008, more than one third of all Parliamentary questions to the Commission in relation to clinical trials addressed this issue⁶⁷ and civil society groups are heavily engaged in this subject.^{68, 69, 70} This is not surprising, since it is evident that clinical trials performed in non-EU countries, whose results are used in the EU, are more difficult to supervise and control.
84. Thus, due to the difficulties to supervise and control clinical studies performed in non-EU countries, there is a continuing risk that advances in health in the EU will be based on clinical research not complying with the international standards adopted to guarantee the reliability of the results and protection of the subjects.

⁶⁶ Point 8 of the introduction to Annex I of Directive 2001/83/EC. The introduction to Annex I of Directive 2001/83/EC has, as the entire Annex, legally-binding force as secondary Union law.

⁶⁷ See also the study commissioned by the European Parliament - Directorate-General for External Policies of the Union: “Clinical trials in developing countries: How to protect people against unethical practices”, April 2009 - http://somo.nl/publications-en/Publication_3035/at_download/fullfile.

⁶⁸ Final report of the expert meeting ‘Clinical trials and protection of trial subjects in low-income and developing countries’, Wemos, January 2008.

⁶⁹ “Ethics for Drug Testing in Low and Middle Income Countries – Considerations for European Market Authorisations”, SOMO, February 2008.

⁷⁰ “Ethical concerns in clinical trials in India: an investigation” of the Centre for Studies in Ethics and Rights, Mumbai, India., February 2009; http://www.fairdrugs.org/uploads/files/Ethical_concerns_in_clinical_trials_in_India_An_investigation.pdf.

1.8. 2.3. Union powers and subsidiarity

85. Union legislation on clinical trials is based on Article 114 of the Treaty on the Functioning of the European Union (TFEU). It aims at harmonising the regulatory framework for pharmaceutical products, including the authorisation of their placing on the market. Harmonised rules open up the possibility of referring to the results and findings of clinical trials in applications for an authorisation for placing a medicinal product on the Union market, including subsequent variations and extensions of the marketing authorisation. In regulating clinical trials, the Union exercises its shared competence in accordance with Article 4(2) of the TFEU.
86. This is critically important in the case of clinical trials because practically every larger clinical trial is performed in more than one Member State (see point 2.1.1).
87. An additional factor is that medicinal products intended for research and development trials are excluded from the Community Code for medicinal products for human use.⁷¹ IMPs may have been produced in a different Member State from that where the clinical trial is conducted. Thus, these products do not benefit from the secondary Union law ensuring their free movement while maintaining a high level of protection of human health.
88. Situations like this were dealt with unsatisfactorily until the Clinical Trials Directive came into force. The laws, regulations or administrative acts differed from one Member State to another. These differences between national laws forced marketing authorisation holders to adapt their applications for authorisation to place their medicinal product on the market. They also hindered distribution of these products. This had a direct effect on the completion and operation of the internal market.
89. To address this issue, it was necessary to harmonise the rules in place on the internal market. It would not have been possible for each Member State individually to establish identical rules. The EU legislation on clinical trials attempts to meet this need. It lays down, at Union level, the rules of procedure to be complied with on, *inter alia*, authorisation and performance of clinical trials, including safety reporting and manufacturing and labelling of medicinal products used in a clinical trial. These rules are exhaustive, i.e. they are not 'minimum standards'. Member States are not allowed to 'add to' these rules.
90. Any changes made to these rules by Member States would conflict with the requirements of the Treaty, as only the Union can amend them.
91. This assessment also applies to legal acts adopted on the double legal basis of Article 114 and Article 168(4)(c) TFEU. Article 168(4)(c) TFEU provides an additional legal basis which was introduced into primary EU law by the Lisbon Treaty. Article 168(4)(c) TFEU confirms that the Union legislator, in order to meet common safety concerns, can set high standards of quality and safety for medicinal products. Since the entry into force of the Lisbon Treaty, all secondary legislation in the area of pharmaceuticals was based on this 'double legal basis'.⁷²
92. Having said this, in the case of regulation of clinical trials, while Union law on clinical trials has to comply with the rights, freedoms and principles set out in the

⁷¹ Article 3(3) of Directive 2001/83/EC.

⁷² See the first citation in Directive 2010/84/EU (OJ L348, 31.12.2010, p. 74), Directive 2011/62/EU (OJ L174, 1.7.2011, p. 74) and Regulation (EU) No 1235/2010 (OJ L348, 31.12.2010, p. 1).

Charter of Fundamental Rights of the European Union⁷³, the Treaty sets limits as regards harmonisation of ethical aspects of authorisation and regulation of clinical trials. Ethical aspects relate, in particular, to the need to obtain ‘informed consent’ from the subject or the legal representative. Any medical intervention requires consent from the patient but this is particularly critical for a clinical trial. Indeed, irrespective of the risk which a clinical trial may pose to a patient, the mere fact that the treatment is part of an experiment renders it necessary — from an ethical viewpoint — to obtain the informed consent of the subject. Hence, apart from some general principles set out in the Clinical Trials Directive, the detailed aspects of informed consent are of an ethical nature and intrinsically of national competence. Therefore they are not included in the scope of this harmonisation of regulation of clinical trials.

93. There are also several aspects which are of an intrinsically national nature, in particular:

- Rules for establishing who is a ‘legal representative’ of a subject who cannot give informed consent (for example, because the subject is a child): these rules differ widely across the EU, depending on national tradition and practices;
- Rules on the extent of and prerequisites for liability for damages suffered by a subject: these rules are deeply rooted in national civil law on medical liability. This applies not only to the degree of negligence (e.g. no-fault or objective liability) but also to the rules on the burden of proof and for calculating the extent of damage.

94. Consequently, while regulation of clinical trials and, in particular, revision of the existing Clinical Trials Directive, is compatible with the principle of subsidiarity, there are limits set by the Treaties which have to be considered when formulating the policy options.

3. OBJECTIVES

95. In accordance with the 2008 Pharmaceuticals Communication of the European Commission the general policy objective is to make the EU a more attractive place for conducting clinical trials by improving the regulatory framework for clinical trials in the EU, while taking into account the global dimension of clinical trials.

96. More specifically, the following policy objectives shall be defined:

1.9. **3.1. Objective No 1: A modern regulatory framework for submission, assessment and regulatory follow-up**

97. Objective No 1 shall be defined as 'a modern regulatory framework for submission, assessment and regulatory follow-up of applications for clinical trials, taking into account the multinational research environment'.

98. In terms of **operational objectives**, this means the following:

⁷³ Article 6(1) of the Treaty on European Union.

- Reducing those administrative costs⁷⁴ which are 'administrative burdens',⁷⁵ and reducing other compliance costs;⁷⁶
- Reducing the delay between finalisation of the protocol and the start of the trial, as far as this delay is caused by regulatory impediments.

1.10. **3.2. Objective No 2: Regulatory requirements which are adapted to practical considerations, constraints and needs, without compromising the safety, well-being and rights of participants in clinical trials and without compromising data robustness**

99. Objective No 2 shall be defined as 'regulatory requirements which are adapted to practical considerations, constraints and needs, without compromising the safety, well-being and rights of participants in clinical trials and without compromising data robustness'.

100. In terms of **operational objective**, this means reduction of the administrative burden and other compliance costs created by two key regulatory requirements in the Clinical Trials Directive: The annual safety report and the obligatory insurance/indemnity (see point 2.2.2). This operational objective targets in particular non-commercial sponsors who do not have access to the same (human and financial) resources as industry sponsors (see point 2.2.2).

1.11. **3.3. Objective No 3: Addressing the global dimension of clinical trials when ensuring compliance with GCP**

101. In terms of **operational objective**, this means **ensuring compliance with GCP** of clinical trials conducted in non-EU countries but referred to in the EU in the context of another clinical trial or of an application for a marketing authorisation.

1.12. **3.4. Coherence with strategic policy objectives of the EU and the Commission**

102. The general, specific and operational objectives can be seen as part of larger, strategic, policy objectives of the EU and the Commission. These include in particular:

- The objective of 'Smart growth – an economy based on knowledge and innovation': In its Communication 'Europe 2020 – a strategy for smart, sustainable and inclusive growth'⁷⁷ the Commission has called for strengthened research performance, stressing that '*Europe needs to focus on the impact and composition*

⁷⁴ 'Administrative costs' are defined as the costs incurred by enterprises, the voluntary sector, public authorities and citizens in meeting legal obligations to provide information on their action or production, either to public authorities or to private parties (cf. European Commission Impact Assessment Guidelines, Part III, page 46).

⁷⁵ 'Administrative burdens' are administrative costs which are generated solely because of a legal obligation, i.e. it excludes administrative costs which an actor would have had anyway, even in the absence of the legislation (cf. European Commission Impact Assessment Guidelines, Part III, page 45).

⁷⁶ For the purpose of this impact assessment, the term 'other compliance costs' shall be defined as costs for compliance with regulation, other than administrative costs (cf. European Commission Impact Assessment Guidelines, Part I, point 2.3, page 10).

⁷⁷ COM(2010) 2020, 3.3.2010.

of research spending and to improve the conditions for private sector R&D in the EU.⁷⁸

- The objective to 'Reducing inequalities in health' and to 'base health policy on the best scientific evidence derived from sound data and information, and relevant research': In its White paper 'Together for health: A strategic approach for the EU 2008-2013'⁷⁹ the Commission committed to these objectives as part of a 'strategy based on shared health values' which was defined as one of the four fundamental EU actions on health;
- The objective of a 'Simplification of the regulatory environment' in the EU: In its Communication 'Implementing the Community Lisbon programme: A strategy for the simplification of the regulatory environment'⁸⁰ the Commission committed to a simplification strategy at EU level. The annual work programmes of the Commission contain a Simplification Rolling Programme. The 2011 work program includes the revision of the Clinical Trials Directive;⁸¹
- The objective of 'Reducing administrative burdens in the European Union': In its Communication 'Action Programme for Reducing Administrative Burdens in the European Union'⁸² the Commission has called for a joint reduction target of administrative burdens, caused by EU and national legislation of 25%, stressing that pharmaceutical legislation should be a priority area of action.

Regarding the strategic policy objectives to simplify the regulatory environment and reduce administrative burdens the Commission has re-confirmed its ambition in its Communication of 2010 'Smart regulation in the European Union'.⁸³

4. POLICY OPTIONS

1.13. 4.1. Objective No 1 — A modern regulatory framework for submission, assessment and regulatory follow-up of applications for clinical trials

1.1.6. Policy option No 1/1 — No action at Union level and reliance on voluntary cooperation of Member States (baseline option)

103. In this policy option (see chart under point 2.2.1.1) no action would be taken at EU level.

104. With regard to this option, it has to be highlighted that Member States have started, on a voluntary basis, to cooperate and jointly assess applications for authorisation of clinical trials under the 'voluntary harmonised procedure' (VHP). This procedure was set up by Member States without the involvement of the Commission or the Union co-legislators. It is based on voluntary parallel submission to all participating Member States of a dossier requesting authorisation of a clinical trial.⁸⁴ Once

⁷⁸ See also the Commission Communication on the 'Europe 2020 Flagship Initiative Innovation Union' (SEC(2010) 1161, 6.10.2010).

⁷⁹ COM(2007) 630, 23.10.2007.

⁸⁰ COM(2005) 535, 25.10.2005.

⁸¹ Commission Work Program 2011, COM(2010) 623, 27.10.2010, Annex III, point 41.

⁸² COM(2007) 23, 24.1.2007.

⁸³ COM(2010) 543, 8.10.2010.

⁸⁴ http://www.hma.eu/uploads/media/VHP_public_CBB_22_Dec_08_hk_jan12.pdf.

Member States have informally agreed on authorisation of the clinical trial, the dossier is re-submitted formally to each Member State. The impact of the VHP in view of the specific and operational objectives is discussed in point 5.1.1.

1.1.7. Policy option No 1/2 — Single submission with separate assessment

105. This policy option would consist of central submission, via an IT gateway located at EU-level, and subsequent separate assessment by the EC and the NCA of each Member State concerned.

106. Thus, this policy option would be limited to an IT-functionality. Nevertheless, a single submission, instead of the multiple submission process (see problem identification under point 2.2.1 and the presentation of the baseline under point 5.1.1) would reduce administrative burden and thus contribute to the operational objectives in specific objective No 1 (see point 3.1). The impact of this policy option is discussed below (point 5.1.2).

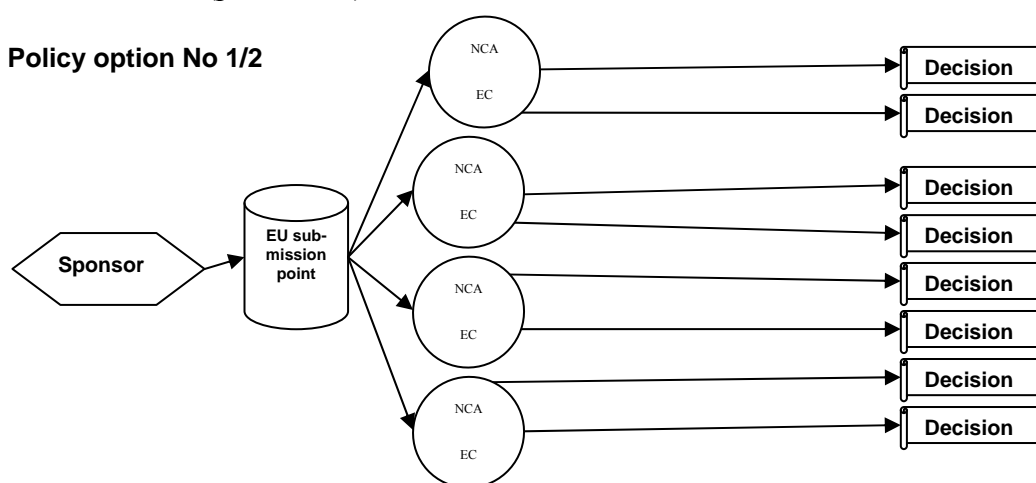

1.1.8. Policy option No 1/3 — Single submission with joint assessment by Member States of issues not related to ethical aspects

107. This policy option would consist of central submission and subsequent joint assessment by the Member States where the clinical trial takes place. Apart from the reduction in administrative costs and burdens created by multiple submissions, a joint assessment of the clinical trials application would help to avoid diverging assessments and thus reduce further administrative burdens, other compliance costs, and delays of the launch of the trial (see point 3.1 and the discussion on the impact of this policy option in point 5.1.3).

108. Under this policy option the dimensions of a clinical trial touching on ethical aspects, however, would remain within the ambit of each individual Member State (see point 2.3).

109. Concerning the aspects assessed jointly, one Member State would take up the task of coordinating the input from all Member States concerned, and draft the assessment report. This 'reporting Member State' would be determined by the sponsor. It can be expected that, in practice, the sponsor is most likely to choose the Member State where the sponsor is established.

110. Regarding the aspects assessed jointly, the conclusion would be binding for all Member States concerned, unless a Member States 'opts out' from these conclusions, and consequently from this clinical trial. This 'opt out' could only be invoked in the specifically qualified circumstance of a serious risk to subject safety based on significant differences in normal clinical practice in that Member State. As set out above (point 2.2.1.1), the cases where there would be a genuine disagreement about the acceptability of a clinical trial as such are rare. Therefore, 'opt-outs' are going to be the exception.
111. At the end of the assessment phase, each Member State would issue a single authorisation decision covering both the non-ethical and ethical aspects. Thus, this policy option would consist of one 'integrated decision' of both, non-ethical and ethical aspects.
112. In terms of timelines, sponsors could realistically expect to receive approval or non-approval of a clinical trial within 60 days of submission of the dossier.
113. The assessment would be made only by the Member States concerned and the conclusions would be valid for them only. If, after approval, the sponsor intends to roll out the clinical trial to another Member State, this would have to be approved separately.

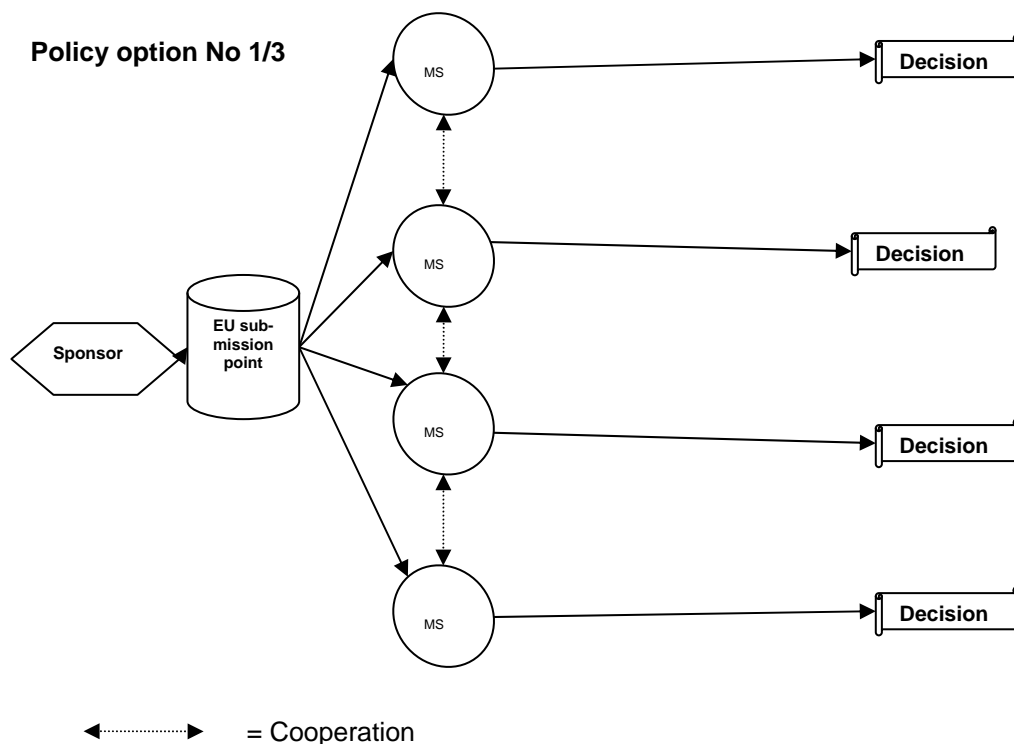

114. Under this policy option the involvement of the Commission or the Agency (apart from the single submission point, see above) would be limited to technical support of the joint assessment, and to act as 'facilitator' in the joint assessment.
115. The impact of this policy option is discussed below (point 5.1.3).

1.1.9. Policy option No 1/4 — Single submission with central assessment by the Agency of issues not related to ethical aspects

116. As in policy option No 1/3 this option would build on a cooperation of member States in assessing the clinical trial application.
117. However, this policy option would be modelled after the 'centralised authorisation procedure' for medicinal products. This procedure has been established in 1995 in order to address difficulties in the authorisation of medicinal products. These difficulties are in some respects similar to those for clinical trials today as presented above (2.2.1).
118. Policy option No 1/4 would consist of a central submission and subsequent central assessment by a scientific committee located and administered within the Agency. The basic principle of the working of the scientific committees located with the Agency is the involvement of all Member States in the Committee structure.
119. Within the Committee, a 'rapporteur' would be established on the basis of mutual agreement. The 'rapporteur' would be charged with drafting the assessment report.
120. In case of disagreement of a Member State with the rapporteur's opinion, the Committee would proceed to a vote on the basis of majority voting.
121. On the basis of the opinion, the Agency (or, if legally required, the Commission) would issue an authorisation decision which would be valid for the entire Union.
122. In addition, each Member State concerned would issue a national decision covering the ethical aspects of the clinical trial (see point 2.3).
123. Thus, unlike in policy option No 1/3 (with an 'integrated decision'), this policy option would build on a 'dual decision', as is the case today (see point 2.2), on a "per Member State" basis.

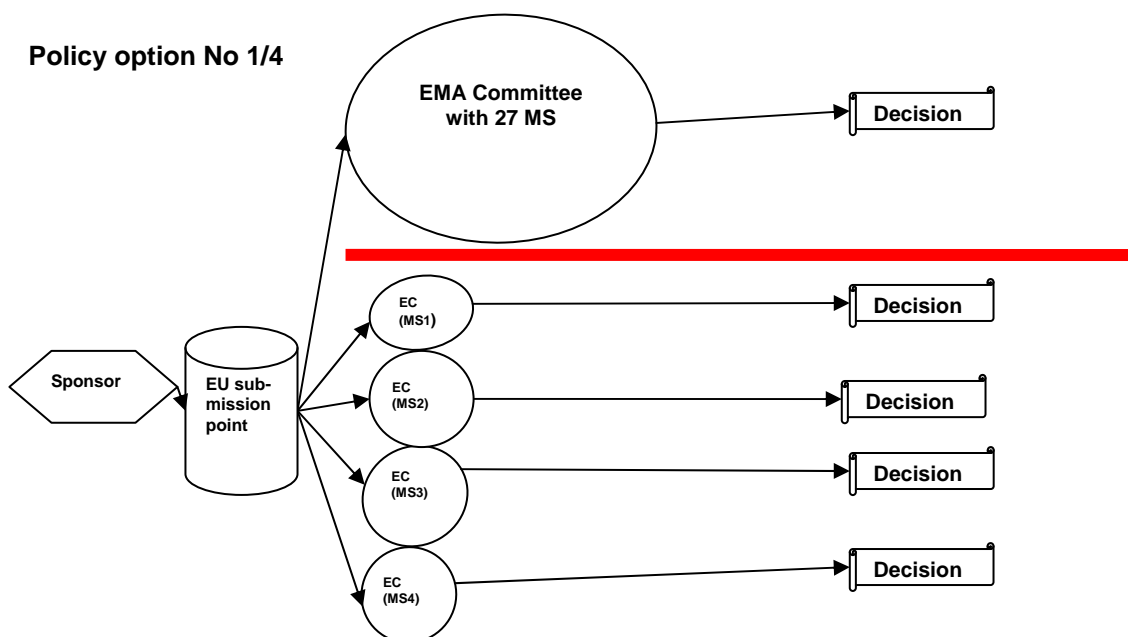

124. As with the centralised procedure for medicines, the Agency would provide for a secretariat of the responsible EMA Committee. Moreover, each product/procedure

would be followed closely by a dedicated team of EMA staff, including a 'team leader' and support staff.

125. This policy option would be intended to meet the operational objective of reducing administrative burden, as well as other compliance costs. Moreover, it would be intended to meet the operational objective of reducing delays for the start of a clinical trial (see point 3.1). The impact of this policy option is discussed below (point 5.1.3).

1.1.10. Policy option No 1/5 — Choice of legal form — Adopting the text of the Clinical Trials Directive in the form of a Regulation

126. This is not an alternative to policy options No 1/1 to 1/4, but a possible add-on (cumulative policy option). It focuses on the legal form of the text. This option would replace the Clinical Trials Directive by a Regulation. Unlike a Directive, which only binds Member States as to the result to be achieved while leaving to them the choice of form and methods,⁸⁵ a Regulation would obviate the need for national transposition measures.

127. Adoption of a Regulation would require Member States to repeal, with effect from the date of application of the Regulation, their existing national regulations transposing the Clinical Trials Directive.

1.1.11. Policy option No 1/6 — Combination of policy option No 1/3 and No 1/5

128. This policy option would 'combine' the policy options No 1/3 (joint assessment) with the policy option No 1/5 (legal form of a Regulation).

1.14. 4.2. Objective No 2 — Regulatory requirements adapted to practical considerations and needs

1.1.12. Policy option No 2/1 — No action at Union level (baseline option)

129. This policy option would leave the situation as it is. Member States cannot act or can act in only a very limited manner, as the Clinical Trials Directive is based on the principle of exhaustive harmonisation.

1.1.13. Policy option No 2/2 — Enlarging the scope of non-interventional trials

130. The Clinical Trials Directive applies only to 'interventional trials', but not to 'non-interventional' trials.⁸⁶ Non-interventional trials are trials which meet all four of the following conditions:

- the medicinal product is prescribed in the usual manner in accordance with the terms of the marketing authorisation;
- the assignment of the patient to a particular therapeutic strategy is not decided in advance by a trial protocol but falls within current practice;

⁸⁵ Cf. third paragraph of Article 288 of the TFEU.

⁸⁶ Article 1(1) of Directive 2001/20/EC. The terms 'non-interventional study' and 'non-interventional trial' are used here interchangeably.

- prescription of the medicine is clearly separated from the decision to include the patient in the study;
 - no additional diagnostic or monitoring procedures are applied to the patients and epidemiological methods are used for the analysis of the collected data.
131. The reason for excluding non-interventional trials from the scope of the Directive is that they typically pose a lower risk than interventional trials. In addition, this restriction is meant to exclude medical activities which are normal clinical practice and, as such, part of the general medical surveillance of a patient.
132. This policy option would broaden the scope of non-interventional studies by removing the fourth of the four cumulative requirements. This would mean that any study using authorised medicinal products for their authorised indication, even with additional intervention, would fall outside the scope of the Clinical Trials Directive if the subjects are not assigned prospectively, for example by randomisation. Consequently, the administrative burden and other compliance costs would be reduced for these studies which would be in line with the operational objective defined in point 3.2.
133. This approach was suggested by several stakeholders during the 2011 public consultation.

1.1.14. Policy option No 2/3 — Excluding ‘non-commercial sponsors’

134. One policy option to address the specific and operational objective is to exclude generally ‘non-commercial sponsors’ from the scope of the Clinical Trials Directive. If ‘non-commercial sponsors’ were excluded, their studies would not be regulated any more by the Clinical Trials Directive and non-commercial sponsors would not be affected by the administrative burdens and other compliance costs caused by this legislation. Thus, the operational objective defined in point 4.1.2. would be achieved.
135. The approach set out in this policy option applies in the U.S. and in Japan.⁸⁷ This policy option was much discussed as an option during the legislative process of the Clinical Trials Directive between 1997 and 2001. In the years following the adoption and entry into force of the Clinical Trials Directive, there were frequent calls for a revision of that text with the aim to excluding 'non-commercial sponsors'.⁸⁸

1.1.15. Policy option No 2/4 — Removing regulatory requirements on the basis of the knowledge of the IMP

136. As mentioned earlier (see points 2.1.1 and 2.2.2), clinical trials are performed not only with unknown compounds, but also with authorised and well-known medicines. Clinical trials with such authorised/well-known medicines typically pose a low risk compared with normal clinical practice, as the medicine is already on the market and

⁸⁷ See the report of the OECD Global Science Forum - Facilitating International Cooperation in Non-Commercial Clinical Trials (2011), p. 9.

⁸⁸ This viewpoint was recently reiterated by non-commercial sponsors in McMahon, Conway, MacDonal, McInnes, The unintended consequences of Clinical Trials Regulation, PLOS Medicine, November 2009, Issue 11: "We would favour a combined tactic of lobbying to simplify and 'regulatory retreat' and perhaps we could then look forward to more 'specific modality' exceptions for non-commercial trials in future legislation".

has undergone a marketing authorisation procedure and obtained subsequent approval.

137. This policy option would remove regulatory requirements for clinical trials with authorised medicinal products used for the authorised indication or with medicines used in a well-known use. This would reduce the regulatory burden and thus costs, thereby contributing to the operational objective defined in point 4.1.2. Moreover, clinical trials with authorised IMPs are typically conducted by non-commercial sponsors. Thus, the operational objective with regard to non-commercial sponsors would be addressed.

1.1.16. Policy option No 2/5 — Insurance/Optional ‘national indemnification mechanism’

138. Under this policy option Member States would set up a national indemnification mechanism which provides for indemnification for clinical trials performed on their territory, taking account of the national legal system for liability.⁸⁹ Such national indemnification mechanism already exists in some of the Nordic Member States.

139. On the basis of these experiences, such national indemnification mechanism would work as follows:

- The sponsor/investigator, instead of concluding a private liability insurance, has the possibility to refer in the clinical trial application to the national indemnification mechanism. This may be free of charge or subject to a payment – depending on the arrangement in the Member State;
- A clinical trial participant suffers a damage in a clinical trial;
- This damage is to be compensated by the sponsor or investigator in accordance with national liability laws (special liability laws or general private law);
- Where the damage is to be compensated, the national indemnification mechanism pays the damages to the subject;
- Depending on the arrangements of the Member State, the national indemnification mechanism turns to the damaging sponsor/investigator to recoup the compensation payment.

140. Thus, a national indemnification mechanism would have the following features:

- It would be optional for sponsors to join such an indemnification mechanism. Sponsors who opt out would have to obtain cover on the insurance market;
- Member States would establish the way of financing the national indemnification mechanism. They could either make it subject to a contribution by the sponsor or publicly-funded — at least where the clinical trial is not intended to generate data for a future application for marketing authorisation.
- Apart from these general principles, it would be up to each Member State to decide the details of the national indemnification mechanism and, in particular, whether, in case of a payment to a damaged patient, the national

⁸⁹ Some Nordic MS have already such indemnification system in place.

indemnification mechanism can take action against the damaging party (sponsor or investigator).

- The national indemnification mechanism would not interfere with national rules on liability (degree of negligence, if any, burden of proof, etc.).

141. Such mechanism would greatly facilitate assuring insurance coverage and costs for this coverage would be limited to the costs caused by damage that actually occurs. Administrative burdens and other compliance costs would be reduced (see, for a discussion on the impact, point 5.2.5), thus addressing the operational objective of cutting costs created by the obligatory insurance/indemnity.

142. Such mechanism could only be established at national level, not at EU-level, as the liability rules in the EU Member States diverge largely in terms of negligence, burden of proof, and compensated damage.

1.1.17. Policy option No 2/6 — Combination of policy option No 2/4 and No 2/5

143. In this policy option the policy options No 2/4 and No 2/5 would apply cumulatively. This is only relevant insofar as the obligatory insurance/indemnification is concerned: This obligatory insurance/indemnification would not apply for low-risk trials. For other than low-risk trials, the national indemnification mechanism in policy option No 2/5 would apply.

1.15. 4.3. Objective No 3 — Addressing the global dimension of clinical trials when ensuring compliance with GCP

1.1.18. Policy option No 3/1: Leaving the situation as it is (baseline option)

144. The ‘self-regulation’ option would mean continuing to rely on:

- Voluntary commitment on the part of sponsors to ensure that clinical trials in non-EU countries are performed in accordance with GCP;
- Regulatory supervision and inspections by non-EU countries in their jurisdictions;
- Some inspections by the inspectors of Member States in the framework of applications for marketing authorisation.

1.1.19. Policy option No 3/2: Facilitating GCP inspections by increasing transparency

145. This option would put sponsors under an obligation to register publicly all clinical trials whose results are used subsequently in an application for authorisation of a clinical trial or for marketing authorisation for a medicinal product.

146. Such official public register is already in place in the EU: The ‘Clinicaltrialsregister.eu’⁹⁰ has been launched in early 2011. This public register is, however, not open for registrations of clinical trials which are performed exclusively

⁹⁰ <https://www.clinicaltrialsregister.eu/>.

in third countries. Rather, this public register is limited to clinical trials which are performed in at least one Member States.⁹¹

147. The aim of such public registration would be to allow enforcement authorities to intervene and police these clinical trials. It would also build up pressure for sponsors to comply with GCP.

1.1.20. Policy option No 3/3: Inspections of non-EU countries' regulatory systems for clinical trials

148. According to pharmaceutical law, any clinical trial in third countries which is referred to in a marketing authorisation application has to be conducted on the basis of principles which are equivalent to those applied in the EU (see point 2.2.3).

149. Under this policy option the effective application of this 'equivalence rule' would be strengthened by introducing inspections of third country regulatory systems ('system inspection', sometimes referred to as 'audits') in order to verify whether the third country regulatory system, and its control and enforcement, is equivalent to that in the EU as far as subject rights and safety and data robustness is concerned.

150. Thus, this policy option would put in place a system of inspection of third countries' regulatory systems for clinical trials.

1.1.21. Policy option No 3/4: GCP inspections of non-EU countries' clinical trial sites

151. This policy option would give the Agency the task of performing inspections in non-EU countries itself, i.e. without drawing on inspection capacity provided voluntarily by Member States. Consequently, the Agency would not have to rely exclusively on inspectors provided by Member States.

152. Unlike policy option No 3/3 this policy option would not target the regulatory system of the third country, but it would target individual clinical trials sites, sponsor establishments, or establishments of actors to which the sponsor has outsourced certain tasks.

1.1.22. Policy option No 3/5 — Combination of policy option No 3/2 and No 3/3

153. This policy option would combine a strengthened transparency (policy option No 3/2) with inspections of non-EU countries' regulatory systems for clinical trials.

5. IMPACT OF POLICY OPTIONS

General remarks

154. In assessing the policy options, the focus is on the social and economic impacts. Regarding environmental impacts, in principle the policy options discussed here do not have a direct or noteworthy indirect impact. However, should there be such an impact this is highlighted in the assessment of the respective policy option.

⁹¹ In addition, in accordance with Regulation 1901/2006 on medicinal products for paediatric use information on paediatric clinical trials contained in a paediatric investigation plan has to be uploaded in this register – even if these trials are performed exclusively in third countries.

Regarding social impacts, the key aspect to consider is the impact on public health and patient health and safety.

155. Regarding the economic impacts, it is to be stressed that approximately 9% of the clinical trials are run under the responsibility of an actor which falls within the EU definition of 'Small and Medium Enterprise' ('SME', see Annex 2). This relatively low figure compared to other sectors can be explained by the fact that 'academic sponsors' are not considered as SMEs (see Annex 2 for details). Therefore, all costs created or saved by the policy options concern to approximately 9% SMEs. Where there is a specific impact on SMEs this is going to be specifically highlighted.
156. Regarding micro-enterprises (see Annex 2), in view of the complexities of the regulatory and business environment for conducting clinical trials in Europe, it can be assumed that there are practically no micro-enterprises active in this sector.
157. The Commission, in its Communication 'Strategy for the effective implementation of the Charter of Fundamental Rights by the European Union',⁹² has committed to examine the impact of legislative proposals on fundamental rights where such an assessment is relevant. The fundamental rights are laid down in the Charter of Fundamental Rights of the European Union ('the Charter').⁹³ However, in accordance with the Commission guidance in COM(2010)573,⁹⁴ this does not mean an examination of the draft act's legal compliance with fundamental rights, which is carried out at a later date on the actual draft act.
158. The conduct of a clinical trial may impact Article 1 ('Human dignity') and Article 3 of the Charter ('Right of the integrity of the person'). The regulation of the conduct of a clinical trial may impact on Article 13 of the Charter ('Freedom of the Arts and the sciences'), as well as Article 35 of the Charter ('Health care') and Article 16 of the Charter ('Freedom to conduct a business').
159. The socioeconomic impacts are thus intrinsically linked with impacts on fundamental rights as set out in the Charter:
- Any decrease/increase of patient safety is a negative/positive impact on Articles 1 and 3 of the Charter;
 - Any reduction/increase of costs for conducting clinical trials (be they administrative burden or other compliance costs) is to be seen as positive/negative impact on Articles 13, 16 and 35 of the Charter.
160. Therefore, impacts on fundamental rights are going to be addressed through the assessment of the socioeconomic impacts of each policy option. However, if an impact is particularly critical, this is explicitly highlighted.
161. Regarding implementation costs (staff and IT) for the Commission and the Agency, it is crucial to assess these in view of the resources available in the Multiannual

⁹² COM(2010) 573, 19.10.2010.

⁹³ OJ C83, 30.3.2010, p. 389.

⁹⁴ Commission Communication on a "Strategy for the effective implementation of the Charter of fundamental rights by the European Union", COM(2010) 573, 19.10.2010, p. 6.

Financial Framework (MFF) 2014-2020.⁹⁵ The impact on implementation costs for any policy option needs to be carefully taken into account.

1.16. **5.1. Objective No 1 — A modern regulatory framework for submission, assessment and regulatory follow-up of applications for clinical trials**

1.1.23. Policy option No 1/1: No action at Union level and reliance on voluntary cooperation of Member States (baseline option)

162. No action would mean that the current situation would persist. This situation (baseline option) can be described as follows:

1.16.1.1.5.1.1.1. Social/health impact

Safety of participants

163. The Clinical Trials Directive has contributed to ensuring subject safety in clinical trials (see point 2.1). However, lack of coordination and cooperation in the assessment phase and the regulatory follow-up can put subjects at risk: follow-up information generated during the assessment is not shared with other Member States concerned.

164. Moreover, the ‘patchwork’ of separate assessment procedures for clinical trials by each Member State concerned does not necessarily ensure the highest possible standard of assessment, as the specialist expertise necessary might not always be readily available in every Member State concerned. This works to the detriment of the safety of participants in clinical trials.

165. Both these points would be addressed by the VHP (see point 4.1.1 for details on the VHP).

Inequalities in access to innovative treatment

166. The baseline option means that the protocol, conduct and design of the same clinical trial can be subject to different changes and adjustments in the authorisation procedure. These divergences can have an impact on data generated in the trial. In principle, *one* clinical trial is supposed to be based on *one* design and to generate *one* set of data. If the conduct and design of the trial diverge, the integrity of the dataset emerging from it could be compromised.

167. As a result, the launch of a clinical trial gets delayed and sponsors may even decide to withdraw the clinical trial from one or more Member States (see point 2.2.1.2). This means that patients in those Member States are deprived of the potential benefits of clinical research, which leads to inequalities in public health.

168. This point would be addressed by the VHP.

⁹⁵ The Commission's proposal for the MFF 2014-2020 is not yet adopted. But the Communication from the Commission to the European Parliament, the Council, the European Economic and Social Committee and the Committee of the Regions "A Budget for Europe 2020" defines some core elements, COM(2011)500 final.

1.16.1.2.5.1.1.2. Economic impact

1.16.1.3. Administrative costs/Administrative burdens

169. At present, the Clinical Trials Directive creates administrative costs of approximately 306m EUR per year (see Annex 3).
170. These high administrative costs, despite the relatively low number of clinical trials, are a direct consequence of the regulatory framework set by the Directive (see point 2.2.1.1). It is very labour-intensive and costly to multiply largely identical administrative procedures for multinational clinical trials — and these costs increase even further if requirements differ for individual countries. Sponsors spend a great deal of time retrieving the relevant information, modifying it, and writing the application for authorisation and follow-up information.
171. These costs are to approximately 80% administrative burdens, as much of this information would not be collected or processed by the sponsor in the absence of legislation. This holds in particular for follow-up information, substantial amendments, annual safety reporting, end of trial reporting, and some aspects of SUSAR reporting (see Annex 3).
172. Despite development of the VHP, the administrative costs remain largely identical, due to the following factors:
- The VHP does not replace the separate national submission procedures: instead, in fact, it produces ‘two waves’ of submission, one under the VHP and, subsequently, national waves. This holds true both for the initial application and for subsequent substantial amendments;
 - The VHP does not extend to other regulatory steps, such as submission of SUSARs, the end-of-trial notification or the annual safety report.

Other compliance costs

173. Apart from the administrative costs, the Clinical Trials Directive also gives rise to other compliance costs. These add up to approximately 2200m EUR per year (see Annex 3).
174. In terms of other compliance costs, one would expect that the VHP (see point 4.1.1) has a favourable impact as the conclusions on an application for authorising a clinical trial are identical in all Member States participating in the clinical trial. Moreover, this identical outcome does not only hold for the actual authorisation ('yes/'no'), but also for accompanying conditions and comments. This is critical as those divergencies lead to additional costs (see point 2.2.1.1). Nevertheless, in 2011, of the approximately 1100 multinational clinical trials applied for in the EU, only 84 applications were lodged by sponsors under the VHP. This moderate success rate of the VHP, with only approximately 8% of all multinational clinical trials being submitted through this procedure is due to the following reasons:
- As the VHP is not derived from legislation, but builds on a voluntary initiative of Member States, there is the continuing possibility that, at the end of the VHP process a Member States does change, for its territory, the assessment or conclusions;

- One large Member State refuses participation in the VHP, and several other Member States decide on their participation on a case-by-case basis.

Delay of launch of a clinical trial

175. The delays for the full launch of a clinical trial (see point 2.2.1.2) do not only have a health impact (see point 5.1.1.1), but also an economic one: In particular industry sponsors have a strong interest in launching a clinical trial quickly once the protocol is finalised. Any unnecessary lengthening of the development process, and be it just 1-2 months, has to be avoided in order to justify investments, and in order to be able to reach quickly the marketing stage.
176. While the VHP shortens the delays which are due to discrepant assessments, it also adds delays: The 'two waves' of submissions (see above under 'administrative costs') lead to an additional delay before a clinical trial is authorised: Once the (non-legally binding) conclusions in the VHP have been made, the actual, formal request for authorisation has to be submitted again to each Member State which leads to an additional approval timeline.

Implementation costs⁹⁶

Resources in Member States

177. Member States have approximately 112 FTEs available in NCAs (see Annex 2) who work specifically on the assessment and follow-up (except safety reporting) of clinical trials (including validation staff, excluding administrative support staff, external resources, and inspection personnel). The personnel in the ECs must be added to this. It is not possible to give a figure for FTEs in ECs, as:
- EC members are usually not full-time members; and
 - ECs also assess other research in addition to clinical trials.
178. There are approximately 950 ECs in the EU entitled to issue a 'single opinion' (see Annex 2). Each EC has approximately 6 to 15 members.

Resources in the Agency and in the Commission

179. The role of the Agency in application of the Clinical Trials Directive is limited to administering EudraCT and to coordinating GCP inspection activity in the centralised authorisation procedure for medicines. For these tasks, the Agency has approximately 2 FTEs.
180. In the Commission, 0.25 FTEs are assigned to all aspects of regulation of clinical trials. This is in line with the financial statement attached to the 1997 proposal for the Clinical Trials Directive.⁹⁷

⁹⁶ Implementation costs are the costs incurred by public authorities involved in implementation. These include, for example, human and infrastructure costs, plus enforcement costs (cf. European Commission Impact Assessment Guidelines, Part III, page 38).

⁹⁷ COM(97) 369 final, 3.9.1997 (published in OJ C 306, 8.10.1997, p. 9).

1.16.1.4.5.1.1.3. Further development in the absence of EU action

181. In the absence of action at EU level, the situation as set out in this baseline scenario would not improve. Rather, in view of the developments which are expected in terms of research with pharmaceuticals (see point 2.2.1.4), if no action is taken the situation is going to aggravate further in terms of social/health impact and economic impact. In particular the VHP does not sufficiently address the problems set out in point 2.2.1: besides the shortcomings highlighted in point 5.1.1.2, the VHP does not address the issue of multiple submissions (which is an important driver of administrative costs) and does not sufficiently address the risk of diverging assessments, leading to additional costs and to the delay of the launch of a clinical trial.
182. Therefore, a careful projection of the current situation (set out in point 2.2) into the future has to lead to the conclusion that, if no action at EU level is taken now to reach the objectives set out in section 3.1, the situation is going to aggravate further both in terms of public health and in terms of costs.

1.1.24. Policy option No 1/2 — Single submission with separate assessment

1.16.1.5.5.1.2.1. Social/health impact

183. As regards the impact on terms of health and patient safety there would be no change compared with the present situation. In particular:
- In terms of social/health impact, there would be no change compared with the baseline option. In particular, this policy option would not bring gains in patient protection: the level of protection would depend on the (differing) assessments by the Member States;
 - The separate assessments would lead to differing conclusions as regards the protocol and, thus, to differing versions of the protocol for the same clinical trial.

1.16.1.6.5.1.2.2. Economic impact

184. This policy option would reduce administrative costs to 45.5 m EUR, i.e. it would save administrative costs of 260.5 m EUR per year compared with the baseline option. Moreover, the share of administrative burdens would decrease more than proportionately, as many multiple reporting obligations would become obsolete in this policy option (see Annex 3). As the assessment procedure would be identical to policy option No 1/1, the administrative costs for follow-up information would remain identical. This is also recognised by stakeholders. During both public consultations all types of stakeholders (patients, non-commercial and industry sponsors) welcomed explicitly the idea of a single submission point, while stressing that the issue of diverging assessments would need to be addressed, too. While many questions on operational details were raised (e.g. related to confidentiality, archiving, authentication, and personal data protection), the policy option in itself was hailed as 'the only way forward'⁹⁸ which would 'greatly reduce the administrative work of sponsors'.⁹⁹ Also Member States 'endorsed' this policy option highlighting that 'it

⁹⁸ Response of EURORDIS-rare diseases Europe to the 2011 public consultation, p. 1.

⁹⁹ Response of the Association of European Self-medication Industry (AESGP) to the 2011 public consultation, p. 1.

may be helpful for sponsors, reduce administrative burden and might facilitate the conduct of clinical trials in EU [...].¹⁰⁰

185. In terms of other compliance costs, however, the situation would be identical to policy option No 1/1, as this policy option is limited to an IT-tool to submit information.
186. In terms of implementation costs, the one-off costs for IT and to running costs vary depending on the technical solution (see Annex 6).
- 'Extensive IT solution' (suggested by the Agency)¹⁰¹: One-off costs would be 6.3m EUR. Running costs would be 1.26m EUR per year. To this add 19 FTEs (11 Administrators and 8 Assistants);
 - "Limited IT solution" (suggested by the Commission)¹⁰²: One-off costs would be 1.62m EUR. Running costs would be 0.34m EUR per year. In addition, 0.25 FTEs are required to provide regulatory expertise.
187. The choice as to which solution is to be pursued is intrinsically linked to the decision as to where the single submission point is located: at the Agency or at the Commission (see Annex 6, point 2 - 'financing strategies'). This would have to be a political decision. A detailed list of arguments to support this decision-making is contained in Annex 8.

1.16.1.7.5.1.2.3. Other aspects

188. This policy option would greatly simplify the regulatory framework for the authorisation and regulatory follow-up of clinical trials. The multiple submissions would be replaced by a 'one stop shop'.

1.1.25. Policy option No 1/3 — Single submission with joint assessment by Member States of issues not related to ethical aspects

1.16.1.8.5.1.3.1. Social/health impact

189. Protection and the safety and rights of participants would improve, as compared with the baseline option, as expertise of different Member States would be brought together: This policy option would ensure that the Member States concerned cooperate on the non-ethical aspects of approval of clinical trials. Such joint exercises could spot any flaws in the assessment and hitherto undetected risks, thus improving the protection given to the subjects and the quality of the clinical research. Moreover, access to clinical trials would be facilitated: As the assessment and conclusions for a clinical trial would be identical situations would be avoided where a clinical trial is not performed in a given Member State due to incompatible requests for changes to the protocol (see point 5.1.1.1).
190. In terms of delays, this policy option would only involve the Member State concerned, i.e. it would involve in practice rarely more than 6-8 Member States (see point 2.1.1). Experience in the VHP has shown that it is in practice well possible for

¹⁰⁰ Response of the HMA to the 2011 public consultation, p.1.

¹⁰¹ This solution would include user validation functionalities, an IT helpdesk, a business support helpdesk, and operational support.

¹⁰² The system would be built on existing IT functionalities.

the Member States concerned to agree on the assessment of a clinical trial application within 60 days. Therefore, it can be expected that the deadlines which exist today for approval of a clinical trial (60 days, see point 2.1.2) is maintained. Moreover, a joint assessment by Member States would remove delays for the start of a clinical trial which occur if the protocol and trial design has to accommodate conflicting assessments and request from different Member States (see point 2.2).

1.16.1.9.5.1.3.2. Economic impact

191. In terms of administrative costs, this policy option would have largely the same impact as No 1/2. In addition, however, there would be a further reduction linked to follow-up submissions, which are administrative burdens (see Annex 3). In this policy option, as the authorisation dossier submitted would be assessed jointly by the Member States concerned, there would also be joint submission of follow-up information.
192. This policy option would reduce administrative costs to 34.3 m EUR, a saving of 271.7 m EUR per year compared with the baseline option (see Annex 3).
193. These savings all concern administrative burdens, i.e. these costs are not going to incur if legislation did not impose them (a sponsor would not voluntarily submit an application file to a Member State individually, if this is already done through a single submission point).
194. In terms of other compliance costs, this policy option would ensure that the conclusions on an application for authorising a clinical trial are identical in all Member States participating in the clinical trial.¹⁰³ This would not only hold for the actual authorisation ('yes'/'no'), but also for accompanying conditions and comments. This would ensure that the same protocol applies in each Member State where the trial is intended to be performed. While it is not possible to quantify these savings to the same degree of precision as for administrative costs, the estimated saving would be in the range of 440 m EUR per year (see Annex 3), i.e. other compliance costs of 1 760 m EUR.
195. It is in particular with a view to the impact on administrative and other compliance costs, as well as in a view of delays, that the majority of all stakeholder groups supported this policy option. For example, practically all non-commercial sponsors welcomed that this policy option "*provides a crucial opportunity to implement a 'risk-based' approach that is consistent across Member States.*"¹⁰⁴ All but one¹⁰⁵ patient associations who responded to the 2011 public consultation favoured this policy option.¹⁰⁶ Pharmaceutical companies and associations – with the exception of some of the very large pharmaceutical companies and EFPIA¹⁰⁷ – supported this policy option, stressing that the assessment of the clinical trial in accordance with this policy option was "*the assessment of choice.*"¹⁰⁸ Finally, Member States

¹⁰³ Provided no Member State invokes the 'opt-out', see point 1.1.8.

¹⁰⁴ Response of the wellcome trust to the 2011 public consultation (p. 3).

¹⁰⁵ Response of the European Genetic Alliances' Network (EGAN) to the 2011 public consultation, p. 2.

¹⁰⁶ See for example the responses from EURDIS (p. 2), ECPC (p. 1) and European Patient's Forum (EPF, p. 2) to the 2011 public consultation.

¹⁰⁷ See below, policy option No 1/4.

¹⁰⁸ Response of the Bundesverband der Pharmazeutischen Industrie (BPI) to the 2011 public consultation, p. 3.

favoured this policy option¹⁰⁹ stressing that some elements of this policy option "could profit from the VHP experience" and expressing "strong support" for the "principle of keeping the clinical trial approval at the national level maintaining the Member State responsibilities on clinical trials conducted in their territories".¹¹⁰

196. In terms of implementation costs, this policy option would reduce costs on the part of the NCAs to the extent that the assessment would be performed in greater depth by just one Member State. However, the basic principle of this policy option is an assessment by all Member States concerned. Therefore, these savings, if any, would be minor.
197. Under this policy option the involvement of the Commission or the Agency (apart from the single submission point, see above) would be limited to technical support of the joint assessment, and to acting as 'facilitator' in the joint assessment (see point 4.1.3). Thus, the role of the Commission or the Agency would not include follow-up of individual authorisation procedures, such as contacts with the applicant, or (assisting in) drafting assessments or grounds for non-acceptance.
198. Rather, the role of the Commission or Agency would be limited to the following:
- Providing meeting room capacities for meetings, where necessary;
 - Preparing and chairing meetings of Member States in order to ensure coherence of the general functioning of the joint assessment procedure with procedural requirements set out in the legislation, including respect of timelines.
199. As set out in Annex 7, this role can have a varying degree of resource needs, depending on whether an 'extensive support structure' (suggested by the Agency) or a 'limited support structure' (suggested by the Commission) would be chosen:
- 'Extensive support structure'¹¹¹: additional resource needs compared to the baseline option would be 7 FTEs (3 administrators and 4 assistants), plus 48.5% overhead.
 - 'Limited support structure'¹¹²: additional resource needs compared to the baseline option would be 1.5 FTE (all administrators, including overhead).
200. Apart from staff, there are travelling reimbursement costs at EU level which range between 102 000 EUR and 210 600 EUR per year, depending as to whether the support is provided by the Commission (i.e. meetings take place in Brussels) or the Agency (i.e. meetings take place in London). For details, see Annex 7.
201. The choice as to the scale of the support structure is linked to the decision as to who provides the support structure: the Agency or at the Commission (see Annex 7, point 2 - 'financing strategies'). This would have to be a political decision. A detailed list of arguments to support this decision-making is contained in Annex 8.

¹⁰⁹ Response of the HMA to the 2011 public consultation, p. 4.

¹¹⁰ Response of France to the 2011 public consultation, p. 2.

¹¹¹ Support to operating process, process development and management, templates, training, working group support, occasional crisis issues, public relation.

¹¹² Support to operating process, working group support

1.16.1.10. 5.1.3.3. Other aspects

202. In this policy option the assessment would be performed only by those Member States where the clinical trial is to take place. Member States where the clinical trial is not intended to be rolled out would not take part in the procedure. This raises the question of how to deal with any subsequent roll-out of a clinical trial ('staggered launch'). In practice, a clinical trial sometimes has to be rolled out in more Member States than originally planned — for example, in order to meet subject recruitment targets.
203. This policy option would therefore have to include a mechanism allowing regulatory approval in additional Member States who join the trial after the initial approval. Even if this additional roll-out happens quickly, it could lead to additional delays and costs for staggered launches of clinical trials.

1.1.26. Policy option No 1/4: Single submission with central assessment by the Agency of issues not related to ethics

1.16.1.11. 5.1.4.1. Social/health impact

204. In terms of social/health impact, this policy option has the benefit of involving all Member States, thus assembling the best expertise of regulators available to the administrations in Europe.
205. However, this option might lead to additional delays in authorisation of clinical trials for the following reasons:
- The system of 'dual decision' (national and EU levels, see point 4.1.4) is likely to lead to contradictions. For example, while, at EU level, a specific condition for a clinical trial might be introduced, this very condition may not be compatible with the requirements set out at national level. These contradictions may lead to the delays which are already currently being experienced (see point 5.1.1.1);
 - The principle functioning of EMA committees, which is based on the principle of involvement of all Member States in the scientific committees, leads to the involvement of Member States which are not necessarily concerned. This would increase the complexity of the discussions, which takes time;
 - A 'committee structure' would take the flexibility out of the authorisation procedure. Today, the authorisation process in the Member States is highly flexible, with recurrent, and also informal, contacts between the assessors and the sponsor. A heavy, very formal, committee structure would deprive sponsors of these advantages;
 - Management by a committee which would meet only occasionally (e.g. once a month) would lead to further delays.
206. In view of some of these arguments it is not realistic to assume that sponsors would receive approval or non-approval of a clinical trial within the current timelines of 60 days. Rather, it has to be expected that a minimum of 90 days is required to assess the application dossier and to reconcile the view of all Member States.

207. In addition, this policy option would lead to an ‘institutional connection’ and ‘continuum’ between the authorisation procedure for clinical trials throughout development of a medicinal product and the marketing authorisation of the resultant product.¹¹³ It could be argued that this is very positive, as the body in charge of assessing new medicines (i.e. the Agency) is also involved in steering the clinical research studies. However, it is crucial to bear in mind that authorisation of a clinical trial must not be confused with authorisation of a medicinal product: in the former, the assessment looks at the benefits and risks of a treatment for a patient (be it a patient in the experimental arm of the trial or in its control arm). This is done in the absence of certainty or knowledge about which is the most favourable treatment. Applications for marketing authorisation, on the other hand, are assessed on the basis of the medicinal product and its intrinsic properties (see point 2.1.2).
208. In other words, for a marketing authorisation it might be desirable to have data from a specific clinical trial, whereas, from the viewpoint of regulation of clinical trials, this trial should not be approved, considering the benefits and risks to the patient.
209. Although this seems paradoxical, this is a logical consequence of the ethical limits to performing clinical research on humans. The basic principle of these limits is that ‘in medical research involving human subjects, the well-being of the individual research subject must take precedence over all other interests’.¹¹⁴

1.16.1.12. 5.1.4.2. Economic impact

Administrative costs/administrative burden

210. In terms of administrative costs, this policy option would lead to dual approval and, thus, two sets of follow-up questions. This would lead to administrative costs of 41.8 m EUR, i.e. savings of 264.2 m EUR. The share of administrative burdens would be similar to the option No 1/1.
211. In terms of other compliance costs, the impact would be similar to policy option No 1/3, i.e. savings of approximately 440 m EUR.
212. In terms of implementation costs, these would relate largely to an additional role of the Agency. As set out in Annex 3, it can be estimated that the additional staff needs would be in the range of 4 000 FTEs per year.
213. In view of these implementation costs, it is crucial to be aware that they would have to be covered through specific fees. These fees would be collected by the Agency, too. In view of the number of clinical trials, these fees for authorisation of a clinical trial would be substantial: This would impact in particular on SMEs and academic sponsors who do not necessarily have the financial resources to cover regulatory fees.
214. The increase in implementation costs, which would be passed on to sponsors in the form of fees, were also the key concern of SMEs and academic sponsors the responses to the two public consultations. Research networks, for example

¹¹³ This reasoning applies only to medicinal products falling within the scope of the centralised marketing authorisation procedure (i.e. authorisation of placing on the market by the European Commission).

¹¹⁴ Point A.6 of the Declaration of Helsinki (2008). See also Article 3 of the Additional Protocol to the Oviedo Convention (2005): ‘The interests and welfare of the human being participating in research shall prevail over the sole interest of society or science.’

acknowledged that the centralised *marketing authorisation procedure* works well and has been a success, but stressed that this model would be 'unworkable' for clinical trials.¹¹⁵ Non-commercial sponsors acknowledged that this policy option was "appealing, but [...] that a procedure involving all Member States in all aspects of each application would cause too much administration. If this [...] would lead to an increased fee, it would definitely be a problem for academic researchers in general."¹¹⁶ Equal concerns were raised by industry associations representing smaller pharmaceutical companies which stressed the need to maintain flexibility, and recalled that very few clinical trials are conducted in more than 5-6 Member States.¹¹⁷ The very large pharmaceutical companies, as well as EFPIA, however, did consider costs and complexities of this policy option as surmountable. Their responses, however, base their opinion on the idea of a 'pool of appropriate experts drawn from across the Member States'¹¹⁸ which would act in full independence from national affiliation. Thus, these responses do not acknowledge the basic principle of inclusion of experts from all Member States into scientific committees at the EMA. The idea of limiting the involvement of the assessment of a clinical trial application to a 'pool of experts' is unrealistic in view of the sensitivity of the matter discussed, i.e. the potential exposure of humans to a medical experiment.

215. For the reasons set out above all Member States strongly opposed this policy option in the 2011 public consultation. Patient organisations viewed this policy option in comparison with policy option No 1/3 and expressed, with one exception,¹¹⁹ support for the latter.

1.16.1.13. 5.1.4.3. Other aspects

216. Voting in case of disagreement: Apart from the delays it may cause, the '(qualified) majority vote' in case of disagreement, as provided in this policy option, raises doubts in terms acceptability and feasibility for the following reasons:

- It would mean that subjects in a given Member States would be exposed to a clinical trial (i.e. a clinical experiment) without the consent of that Member State who is in charge of supervision the conduct of the trial;
- In practice, any result of a majority vote would be circumvented by the outvoted Member State by arguing that the matter at stake touches on ethical issues.

217. Additional roll-out: This policy option would, to some extent, facilitate roll-out to additional Member States (see point 5.1.3, 'other aspects'). However, any such additional roll-out would not be automatic. Instead, it would require an additional assessment of the ethical aspects for each Member State.

¹¹⁵ See, for example, the response to the 2011 public consultation by the *European Network of Paediatric Research at the EMA* (p. 1): "Despite the attractions of a central assessment, analogous to the system available for licensing, the majority of enpr-EMA respondents agreed that at present this would be unworkable in view of the national differences in clinical and ethical practice."

¹¹⁶ Response of the Copenhagen University Hospital to the 2011 public consultation, p. 1.

¹¹⁷ See for example the response of EUCOPE (with a large share of members being SMEs) to the 2011 public consultation: "EUCOPE favours a single submission with a 'coordinated assessment procedure' and not a 'central assessment'. [...] Very few clinical trials are rolled out in more than five or six Member States. A closely coordinated virtual assessment procedure supported by a very good IT infrastructure and involving the relevant country experts may provide a pragmatic and fast solution".

¹¹⁸ Cf. response of EFPIA to the 2011 public consultation, p. 8.

¹¹⁹ Response of the European Genetic Alliances' Network (EGAN) to the 2011 public consultation, p. 2.

1.1.27. Policy option No 1/5 — Choice of legal form — Adopting the text of the Clinical Trials Directive in the form of a Regulation

218. This policy option would ensure that the Member States would base their assessment of an application for approval of a clinical trial on an identical text, rather than on diverging national transposition measures.
219. Moreover, the legal form of a Regulation would provide a more detailed, binding manner to address the procedure for submission of applications for authorisation and for notification of substantial amendments.
220. In practice, experience shows that transposition of the Clinical Trials Directive has been incorrect and has often given rise to additional procedural requirements. This difficulty would be removed with this policy option.
221. Moreover, this policy option would have an important simplification effect. The replacing of transposition measures at national level allows the relevant actors to plan and conduct the clinical trial, including multi-national clinical trials, on the basis of *one* regulatory framework, rather than on the basis of a 'patchwork' of 27 national frameworks in the transposing Member States laws.
222. However, this policy option does *not* address diverging interpretations and implementing practices. This was stressed in particular by Member States during the 2009/10 public consultation who argued that, even if the legal form was a Regulation, requirements would still be interpreted differently by Member States bodies in the practical application, unless a cooperation mechanism is in place.¹²⁰ Therefore, while the legal form of a Regulation would help to achieve the objective, it is not a solution on its own. It would only contribute in conjunction with one of policy options No 1/3 or 1/4 (see above).
223. This policy option was presented to stakeholders in the 2009/10 public consultation. Practically all industry sponsors and a large part of the non-commercial community "undoubtedly preferred"¹²¹ the legal form of a Regulation, highlighting in particular the simplification effect and the difficulties for Member States to cooperate if each Member States works on the basis of 'similar, but different'¹²² national transposing laws. Amongst non-commercial sponsors, however, there were also voices favouring a Directive as this legal form "*would leave more room for interpretation for practical use.*"¹²³ Regarding the question whether the legal form of a Regulation would increase or lower the substantial requirements, fears were voiced that these requirements may increase¹²⁴ or decrease.¹²⁵ In response to these concerns it has to

¹²⁰ See the response of the UK to the 2009/10 public consultation (p. 8): "*The UK believes that a Regulation, despite providing a common legislative basis for clinical trial regulation across the EU, will not fully overcome the differences in interpretation that currently occur between Member States both by sponsors and national competent authorities.*"

¹²¹ Response of the ZU/KL Leuven to the 2009/10 public consultation, p. 3.

¹²² Osborne, Edward, O'Callaghan, Running an international paediatric non commercial clinical trial, Archives of Disease in Childhood, 2009, 94, p. 729-733 (submitted by the authors as response to the 2009/10 public consultation).

¹²³ Response of UK Cancer Research to the 2009/10 public consultation, p. 8.

¹²⁴ See response of EFPIA to the 2009/10 public consultation (p. 22): "*However, a Regulation that accomodates every Member State's national interests and requirements would be disastrous. For a Regulation to improve the situation, it must be written with the principle of risk adaptation foremost in mind.*"

be stressed that the substantial requirements set out in a Regulation would, as in a Directive, be guided by the principles of proportionality and appropriateness while taking account the Treaty on the Functioning of the European Union whereby "*The Commission, in its proposals [...] concerning health, safety, environmental protection and consumer protection, will take as a base a high level of protection taking account in particular of any new development based on scientific facts*"¹²⁶ and whereby "*A high level of human health protection shall be ensured in the definition and implementation of all Union policies and activities.*"¹²⁷

1.1.28. Policy option No 1/6 — Combination of policy option No 1/3 and No 1/5

224. This policy option would 'combine' the policy options No 1/3 (joint assessment) with the policy option No 1/5 (legal form of a Regulation).

225. It would strengthen policy option No 1/3, as the cooperation amongst Member States in policy option No 1/3 would be facilitated if this cooperative work was based on identical legal provisions.

1.1.29. Comparison of policy options for objective No 1 and synergies

226. It has to be stressed that the baseline situation is insufficient to address the problem. This was highlighted repeatedly during the two public consultations by all stakeholders (research community, industry and patients) and also by Member States. Indeed, the launch of the VHP by Member States, without any legal basis and as a purely voluntary initiative, is a sign that the baseline option is unsatisfactory.

227. While policy options No 1/2, No 1/3 and No1/4 have one common element (the single submission point), they are mutually exclusive.

228. The common element, which is part of policy options No 1/2, No 1/3 and No 1/4 greatly reduces administrative costs and burdens and thus contributes to addressing the problem.

229. Policy option No 1/2, however does insufficiently address issues of separate assessments of identical issues in relation to the same clinical trial. In this respect, policy options No 1/3 and 1/4, which address not only the submission process, but also the assessment process of a clinical trial application, are to be favoured.

230. Policy option No 1/3 is also superior to the baseline option with the VHP: There are various structural shortcomings of the VHP which cannot be remedied in the baseline option, but which are addressed with the policy option No 1/3. In particular:

- Policy option No 1/3 provides, unlike the VHP, for a structured cooperation mechanism with legally-binding and enforceable timelines for the cooperation of the Member States;

¹²⁵ See response of the Arbeitskreis Medizinischer Ethik-Kommissionen in der Bundesrepublik Deutschland to the 2009/10 public consultation (p. 7): "*We are also afraid that a Regulation will result in a lower level of patient safety than the current level achieved in Germany.*"

¹²⁶ Article 114(3) TFEU.

¹²⁷ Article 168(1) TFEU.

- Policy option No 1/3 has, unlike the VHP, a clear scope of the joint assessment: Thus, Member State cannot 'escape' a coordination of the assessment by claiming that a given issue is of an intrinsically national or ethical nature;
 - By issuing one 'integrated decision' (see point 4.1.3), the procedure in policy option No 1/3 ensures that the assessment of intrinsically national or ethical issues does not run counter the agreement found between Member States in the joint assessment. The VHP in the baseline option does not address this issue.
 - Policy option No 1/3 provides for strict requirements for the 'opt-out' of a Member State from the joint assessment of the application for the conduct of a clinical trial. This makes the outcome of the authorisation process more reliable and predictable than under the VHP in the baseline option.
 - Unlike in the VHP of the baseline option, policy-option No 1/3 does not require additional submission of a request for authorisation once the joint assessment of the Member States has been finalised.
 - Policy option No 1/3 ensures, unlike the VHP in the baselin-option, that all Member States have to participate in the joint assessment of a clinical trial application, and that this is not left to a case-by-case decision of the Member State concerned.
231. In view of these aspects, policy option No 1/3 is considerable more effective than the VHP of the baseline option.
232. When comparing policy options No 1/3 and No 1/4, it has to be borne in mind that policy option No 1/4 sets up a very heavy system. It involves every Member State, which is not necessary in view of the roll-out of clinical trials. For example, in 2010, of the 4400 clinical trials applied for in the EU, only 168 (approximately 4%) were to be rolled out in eight Member States or more (see Annex 2). Considering this, in view of the additional delays, it seems disproportionate to involve every Member State through a committee structure in the assessment of a clinical trial application.
233. This holds even more as the operational objectives as regards costs and delays are achieved, in policy option No 1/3, equally well as in policy option No 1/4: The high implementation costs of policy option No 1/4, with a considerable increase of personnel at EU-level, do not justify the benefit of a streamlined authorisation procedure, if the same effect can be achieved with the resources required in policy option No 1/3.
234. Moreover, policy option No 1/4, with its rather heavy procedure, would be of little interest to academic sponsors, who typically run clinical trials in fewer Member States than the pharmaceutical industry's very large trials during late stages of product development. In addition, potential fees would create difficulties for SMEs who have limited financial resources for regulatory purposes.
235. Added to this, policy option No 1/4 adds new complexities to the approval procedure, which would be avoided in policy option No 1/3. These stem from the dual approval in policy option No 1/4, which would be necessary in this policy option to take intrinsically national and ethical issues into account. Such dual approval would be avoided in No 1/3.

236. Policy option No 1/3, on the other hand, provides a ‘slimmer’ procedure. For the initial authorisation, it involves only the Member States where the clinical trial is to be performed (a mechanism would have to be set up to allow roll-out to additional Member States subsequently). Under policy option No 1/3 approval is also likely to be cheaper and faster than in No 1/4. This is in particular of interest for academic research and SMEs.
237. Policy option No 1/5 has the benefit of addressing divergent approaches in Member States which do not stem from the application of EU-rules, but from their transposition into national law.
238. Policy option No 1/6 is identical to policy option No 1/3, with policy option No 1/5 as add-on. It would help to ensure a coordinated approach in assessment of a clinical trial and follow-up action, based on identical criteria. This can only really be ensured if the EU legislation is not transposed into 27 separate national laws. While it is very difficult to quantify this impact, from a qualitative viewpoint it is highly relevant.

Overview — Impact of policy options to address objective No 1

	Contribution to addressing the problem ¹²⁸	Health/social impact compared with baseline ¹²⁹	Economic impact/costs (in EUR) for sponsors compared to baseline		Implementation resources/costs for EMA/COM		Other comments
			Other compliance costs	Administrative costs	Costs (other than resources)	Resources	
Policy option No 1/1 (baseline)	(o)	(o)	0	0	-	-	
Policy option No 1/2 (single submission with separate assessment)	(+)	(=)	0	- 260.5 m	One-off: between 1.62m (limited IT solution) and 6.3m (extensive IT solution) Running: between 0.34m (limited IT solution) and 1.26m (extensive IT solution)	Running: between 0.25 FTEs (limited IT solution) and 19 FTEs (extensive IT solution)	
Policy option No 1/3 (single submission with joint MS assessment)	(+++)	(+++)	- 440 m	- 271.7 m	As in policy option No 1/2	As in policy option No 1/2 Additional 1.5 or 7 FTEs (depending on choice for limited or extensive support structure)	
Policy option No 1/4 (single submission with central assessment by the Agency)	(+++)	(++)	- 440 m	- 264.2 m	As in policy option No 1/2.	4 000 FTEs	Longer delays for approval. 'Continuum' between clinical trials authorisation and medicines authorisation.
Policy option No 1/5 (Regulation vs. Directive)	(++)	(+++)	-	-	-	-	Add-on to options No 1/2 to 1/4
Policy option No 1/6 (Combination of Policy option No 1/3 and 1/5)	(+++)	(+++)	- 440 m	- 271.7 m	As in policy option No 1/2	As in policy option No 1/2 Additional 1.5 or 7 FTEs (depending on choice for limited or extensive support structure)	

¹²⁸ +++=very important contribution; ++=important contribution; +=some contribution; o=no contribution.

¹²⁹ +++=very positive impact; ++=positive impact; +=some positive impact; o=no impact; -=negative impact.

1.17. **5.2. Objective No 2 — Regulatory requirements adapted to practical considerations and needs**

239. The policy options discussed in this chapter for achieving objective No 2 directly impact on the two regulatory requirements which were highlighted by stakeholders in both public consultations as particularly disproportionate and burdensome: the obligatory insurance/indemnity and the annual safety report.

240. The impact of the individual policy options on these two regulatory requirements is discussed below.

1.1.30. Policy option No 2/1: No action at Union level (baseline option)

1.17.1.1.5.2.1.1. Social/health impact

Obligatory insurance/indemnity

241. The obligatory insurance/indemnity ensures that, in case of damages caused by a clinical trial, the subject receives compensation — irrespective of the financial means of the sponsor or investigator. This helps to protect clinical trial subjects.

Annual safety report

242. The annual safety report can be a useful tool for NCAs or ECs to supervise and follow up the safety profile of an IMP, particularly if the compound is still largely unknown and not yet authorised.

1.17.1.2.5.2.1.2. Economic impact/costs

Obligatory insurance/indemnity

243. The yearly costs for obligatory insurance/indemnity for ongoing clinical trials in the EU are approximately 75m EUR, plus administrative costs of 1.9m EUR (see Annex 4). On the other hand, approximately 0.025% of all subjects successfully claim compensation for damages suffered in a clinical trial. Each damages claim is worth, on average, between 3 000 and 6 000 EUR (see Annex 4).

Annual safety report

244. The costs for drawing up and submitting the annual safety report are approximately 147.8m EUR per year, to which administrative costs of 5.3m EUR must be added (see Annex 4).

1.1.31. Policy option No 2/2 — Enlarging the scope of non-interventional trials

245. The impact of this policy option would be limited to phase IV studies as, by definition, only phase IV studies concern authorised IMPs used in the authorised indication.

246. If the scope of non-interventional trials were broadened in line with the definition set out above (see point 4.2.2), this would exclude approximately 50% of phase IV studies from the scope of the EU regulation of clinical trials.

1.17.1.3.5.2.2.1. Social/health impact

247. The immediate impact would be that these studies would be regulated at national level by Member States. Depending on the measures taken by each Member State, this would mean tighter, looser or no regulation of this type of study.
248. However, this would also undermine past and future efforts to harmonise these studies and would introduce differences in protection of trial subjects and robustness of clinical data generated in the EU. Moreover, in the medium term this would make it more cumbersome to conduct these studies in the EU.
249. It was against this background that the majority of all stakeholder groups opposed this policy option, but rather supported a wide definition with a risk-based approach (see point 4.2.4).¹³⁰ Some sponsors (both industry and 'non-commercial' sponsors) supported this policy option. However, these respondents called, at the same time for a separate regulatory regime at EU level for non-interventional studies.¹³¹ Member States opposed this policy option.¹³²

1.17.1.4.5.2.2.2. Economic impact/costs

250. As set out in Annex 4, this policy option would generate the following savings:
- Obligatory insurance/indemnity: 3.92 m EUR other compliance costs, plus 123 480 EUR administrative costs.
- Annual safety report: 13.06 m EUR other compliance costs, plus 95 445 EUR administrative costs.
251. However, depending on the measures taken by each Member State, these costs could be pushed up again by regulatory action at Member State level.

1.1.32. Policy option No 2/3 — Excluding 'non-commercial sponsors'

252. In 2010, some 1 620 clinical trials by 'non-commercial sponsors' were authorised. These involved 2 037 applications and 93 242 patients (see Annex 2).

1.17.1.5.5.2.3.1. Social/health impact

253. In terms of impact, this would mean that subjects enrolled in a clinical trial run by a 'non-commercial sponsor' would not be protected at EU level. Nor would the EU rules ensuring the robustness and reliability of data apply.
254. This would be a major drawback in terms of a creating a level playing field for conducting clinical trials in the EU without compromising on protection of rights and safety of patients in the EU and data robustness.

¹³⁰ Response from the Koordinierungszentren für Klinische Studien (KKS Netzwerk) to the 2011 public consultation (p. 5): "This would mean if a risk based approach cannot be adopted, we would urge that the definition is widened."

¹³¹ Response from Pfizer to the 2011 public consultation (p. 5): "It should be made explicit that non-interventional trials are not covered by the revised clinical trials legislation. We suggest that the European Commission develop a separate legal regime for non-interventional trials."

¹³² See the response of HMA to the 2011 public consultation (p. 10) who "agrees not to modify the definition of non interventional trials [...] but to proportionate requirements for clinical trials, on a risk-based approach."

255. This policy option would also have a negative impact on public health in general. Clinical trials run by ‘non-commercial sponsors’ can have a crucial impact on public health as the results may be published and, thus, impact to the choice of treatment options and treatment in general. Publication could also trigger further research into, for example, extension of indications of medicinal products or reduction of the use dosage.
256. Moreover, if clinical trials by ‘non-commercial sponsors’ were excluded from the scope of the Clinical Trials Directive they would not be subject to harmonised rules at EU level. Member States would again be responsible for regulating these trials via national laws. This would introduce differences in protection of trial subjects in the EU. This, in turn, would make conducting these studies in the EU more cumbersome, which is not in the interest of ‘non-commercial sponsors’ performing clinical trials in different Member States.
257. These were also the main arguments put forward by stakeholders in the public consultations of 2009/10 and 2011. Indeed, in both public consultations there was unanimity that this policy options should not be pursued. This is a remarkable development over the past 10 years as, during the legislative discussions on the Clinical Trials Directive and in the years thereafter there were frequent calls for excluding non-commercial sponsors from the scope of the Directive altogether (see point 4.2.3).

1.17.1.6.5.2.3.2. Economic impact/costs

258. As set out in Annex 4, this policy option would generate the following savings:

Obligatory insurance/indemnity: 14m EUR other compliance costs, plus 488 880 EUR administrative costs.

Annual safety report: 59.9m EUR other compliance costs, plus 437400 EUR administrative costs.

259. Depending on the measures taken by each Member State, these costs could be pushed up again by regulatory action at Member State level.

1.1.33. Policy option No 2/4: Removing regulatory requirements on the basis of the knowledge of the IMP

260. Under this policy option, the requirements for obligatory insurance/indemnity and the annual safety report would be removed for clinical trials where the IMP is sufficiently known, i.e. authorised, and used within the authorised indication.

1.17.1.7.5.2.4.1. Social/health impact

261. Clinical trials with authorised medicinal products pose a risk to public health which is only minimally higher to that posed by standard care, if at all. This is because the IMP in the clinical trial has already undergone an authorisation procedure. Its safety profile is therefore sufficiently known.

Obligatory insurance/indemnity

262. Removing the obligatory insurance/indemnity would have no discernible impact on subject protection. Annex 4 shows that the likelihood of an event causing damage is

minimal. Based on the figures available, approximately 0.025% of all subjects enrolled in a clinical trial can be expected to suffer damages which qualify for compensation. While there is no reliable data on this aspect, it is very likely that these damages occur in the setting of non-authorised medicinal products. Moreover, a number of additional types of insurance cover treatment with an authorised medicine, such as:

- Product liability insurance of the marketing authorisation holder for the authorised medicine;
- Professional negligence insurance of the treating physician; and
- Liability insurance of the hospital or healthcare institution where the subject is being treated.

263. In practice, one of these policies, rather than the insurance/indemnity for damages suffered in a clinical trial, is likely to cover any damages.

264. In the 2011 public consultation, where this policy option was explicitly put forward, voices diverged. The views of sponsors as well as patient's associations (who are ultimately the beneficiary of the insurance) were divided: While it was highlighted that 'lifesaving treatments cannot be abandoned simply because of the high cost of the insurance,'¹³³ it was also stressed that risks change and are not always full known. Member States were largely opposed to this policy option as regards obligatory insurance/indemnity.¹³⁴ The two national insurer's associations who responded to the public consultation were opposed.

Annual safety report

265. The absence of an annual safety report for this clinical trial would also have no impact on subject safety. This is because, irrespective of the clinical trial, under the EU legislation on medicinal products¹³⁵ each authorised medicinal product is subject to a 'periodic safety update report' (PSUR), to be drawn up by the marketing authorisation holder. The PSUR is a very useful instrument to assess the safety profile of a compound, as it is based on the broad data on daily use of the medicine and is drawn up by the marketing authorisation holder who might have a better understanding of the compound than a sponsor.

266. This aspect were also the main reason for the clear support for this policy option in both public consultations by all stakeholder groups where in particular issues of safety reporting were raised.¹³⁶

¹³³ Response of ECPC to the 2011 public consultation, p. 3. See also the responses of Parkinson's UK, p. 2.
¹³⁴ There were, however, also other views: See, for example, the response of the *Arbeitskreis medizinischer Ethik-Kommissionen in der Bundesrepublik Deutschland* to the 2011 public consultation (p. 4): "As authorised drugs are available for use anyhow (usually without any special requirements) it is hard to understand why the proper monitoring and documentation of the treatment and its outcome should be 'penalized' by red take, *insurance*, approval by drug authorities and the like."

¹³⁵ Article 107b of Directive 2001/83/EC.

¹³⁶ See, for example, the response of the *Sociedad Espanola de Farmacologia Clinica* to the 2011 public consultation (p. 8): "Waiver from the periodic trial safety report obligation [...]. This is redundant with the periodic safety report on the medicine that is already being submitted to the national competent authority of the marketing authorization holder."

1.17.1.8.5.2.4.2. Economic impact/costs

267. As set out in Annex 4, this policy option would generate the following savings:

Obligatory insurance/indemnity: 7.84 m EUR other compliance costs, plus 246 900 EUR administrative costs.

Annual safety report: 26.1 m EUR other compliance costs, plus 190 890 EUR administrative costs.

268. The savings as regards administrative costs all concern administrative burdens, i.e. these costs are not going to incur if legislation did not impose them: A sponsor would not cover a clinical trial with an authorised medicine in an insurance scheme, as other insurances (product liability insurance, professional negligence insurance of the physician and the hospital, etc. See point 4.2.4) are available. Neither would a sponsor submit an annual safety report unless this was legally required.

1.1.34. Policy option No 2/5 —Insurance/optional ‘national indemnification mechanism’

1.17.1.9.5.2.5.1. Social/health impact

269. A national indemnification mechanism along the lines set out in point 4.2.5 would give the same assurance of compensation for any subject suffering damages as the obligatory insurance/indemnity currently required by the Clinical Trials Directive.

270. Indeed, some Nordic Member States (Denmark and Finland) already have a system like that proposed in this policy option in place.

1.17.1.10. 5.2.5.2. Economic impact/costs

271. In terms of costs, the following differentiation has to be made.

- Costs for covering damages (other compliance costs): While — as with any medical intervention — the potential damage might be high¹³⁷, the actual damage caused by clinical trials is very low. As set out in Annex 4, it can be assumed that the successful claims for damages could total approximately 135 000 EUR per year.
- Costs for Member States to run the national indemnification mechanism (implementation costs): The implementation costs for Member States are relatively low. As indicated in Annex 4, dealing with all incoming claims for damages caused by clinical trials would require approximately 9.75 FTE staff for the entire EU, which is equal to approximately 682 500 EUR per year (see Annex 4).

272. Depending on how the national indemnification mechanism is financed, these two types of costs may be passed on, in a second-round effect, to the damaging party (sponsor or investigator). In this case the contributions of the sponsor would have to cover costs of 817 500 EUR per year (see Annex 4). Compared to the baseline (75m EUR other compliance costs), this is a reduction of other compliance costs of 74.18m EUR.

¹³⁷ In 2006 during phase I clinical trial of monoclonal antibody TGN1412 the subjects to which it was administered developed a severe inflammatory reaction with shock-like symptoms and systemic organs failure.

273. In addition, there are the administrative costs: These would be limited to a bare minimum, as confirmation of insurance/indemnity cover by a Member State should suffice to comply with the regulatory requirement of insurance. The administrative costs of this policy option can be estimated at approximately 238 000 EUR. Compared to the baseline (1.9m EUR), this is a reduction of administrative costs of 1.66m EUR.
274. In the 2011 public consultation this policy option was put forward for comments by stakeholders. The responses varied: Some respondents, in particular from the group of non-commercial sponsors welcomed the concept, stressing that "*the necessary funds required will be much less than what would be spent by public funding agencies on insurance costs.*"¹³⁸ Other responses from sponsors criticised this policy option and pointed at the risks of increased bureaucracy, and the risk of divesting liability to the state. Most stakeholders from all stakeholder groups had additional questions and concerns in relation to whether such mechanism would be funded by fees or otherwise, and whether such mechanism would be able to turn to the damaging party to re-cover compensation payments to patients. In response to these concerns it has to be stressed that this policy option would leave these matters to the Member State setting up this mechanism (see point 4.2.5). Only two of the patient organisations addressed this policy option specifically, and expressed their support.¹³⁹ Member States who voiced their view on this policy option opposed it, stressing that the person who takes a risk should also be liable for damages arising from it and that Member States should not be put under an obligation to indemnify these damages.¹⁴⁰ The two national insurer's associations who responded to the public consultation were opposed.

1.1.35. Policy option No 2/6 — Combination of policy options No 2/4 and No 2/5

275. This policy option is only relevant for the issue of obligatory insurance/indemnification, as policy option No 2/5 only addresses that aspect. As regards the annual safety reporting, the same assessment as in point 5.2.4 applies.
276. Regarding insurance/indemnification it would mean that:
- For clinical trials with an IMP which is authorised, there is no insurance/indemnification which would apply to the general insurance coverages for the treatment of the patient outside a clinical trial (see point 5.2.4.1);
 - For clinical trials with an IMP which is not authorised, the insurance/indemnification is ensured through the national indemnification mechanism.

1.17.1.11. 5.2.6.1. Social/health impact

277. The impact is the sum of the impact of policy options No 2/4 and 2/5, i.e. with regard to clinical trials with authorised medicinal products damages caused by the clinical trial are extremely rare, and would be covered by other types of insurance that cover the treatment of the patient (see point 5.2.4.1). For other clinical trials the national indemnification mechanism would provide coverage (see point 5.2.5.1).

¹³⁸ Response of the Deutsche Forschungsgemeinschaft (DFG) to the 2011 public consultation, p. 3.

¹³⁹ Responses to the 2011 public consultation submitted by EATG (p. 4) and EURORDIS (p. 3).

¹⁴⁰ Cf. response of the MHRA (p. 6) to the 2001 public consultation.

1.17.1.12. 5.2.6.2. Economic impact/costs

278. The impact in terms of costs would be, as regards the annual safety report, identical to policy option No 2/4, as policy option No 2/5 does not concern the annual safety report.
279. Regarding the obligatory insurance/indemnification this policy option reduces the administrative costs created by policy option No 2/5 by an additional 30 870 EUR (see Annex 4). This means that the savings compared to the baseline option created by policy option No 2/5 (1.66m EUR) are increased by the additional savings of 0.03m EUR to 1.69m EUR.
280. The costs for covering damages, as well as implementation costs, would be identical to policy option No 2/5: the clinical trials addressed in policy option No 2/4, pose, if any, a minimal risk to subject safety and other insurance scheme are in place to address these potential damages (see point 5.2.4.1). The national indemnification mechanism would in practice only concern clinical trials which do not fall within policy option No 2/4.

1.1.36. Comparison of policy options for objective No 2 and synergies

281. Policy option No 2/1 is not satisfactory, as it does not address the problem identified in point 2.2.2. Policy options No 2/2 to No 2/5 should be discussed instead, as they all offer an effective means to address the issue. In particular, all four other policy options offer significant savings (economic impact).
282. Out of these policy options, No 2/2 has one major drawback: the ‘shifting back’ to Member States of the powers to regulate low-risk clinical trials means that these clinical trials are excluded from any harmonisation of clinical trials at EU level. However, as explained in point 2.2.1.3, it is crucial to facilitate pan-European clinical research with pharmaceuticals in order to address the requirements for sufficiently powered clinical trials.
283. Policy option No 2/3 has been discussed widely in recent years. Today, there is strong consensus not to exempt ‘non-commercial sponsors’ *as such* from regulatory requirements. It is difficult to see why rules designed to protect the safety and rights of participants and the reliability and robustness of data should apply to some types of sponsor but not to others. Besides, it is difficult in practice to establish whether a sponsor is acting in a ‘non-commercial’ or a ‘commercial’ capacity. Commercial use of clinical trial data could be indirect or might not become apparent until after a clinical trial has ended.
284. Both public consultations strongly supported this view.
285. Moreover, there is an issue similar to that discussed for policy option No 2/2: if clinical trials by ‘non-commercial sponsors’ were excluded from the scope of the Clinical Trials Directive, they would not be subject to harmonised rules at EU level. Member States would again be responsible for regulating these trials via national laws. This would introduce differences in protection of trial subjects in the EU and would also make it more cumbersome to conduct such studies in the EU, which is not in the interest of ‘non-commercial sponsors’ performing clinical trials in different Member States.

286. Policy option No 2/4 brings about less savings for sponsors than policy option No 2/3. However, in terms of public health and patient safety it is superior to policy option No 2/3. It leaves aside any differentiation between ‘non-commercial’ and ‘commercial’ sponsors (which is a key weakness of policy option No 2/3) and focuses on an objective criterion: the authorisation status of the IMP. Therefore, in comparison with policy option No 2/2 and No 2/3, policy option No 2/4 seems to be the best way to achieve the objective.
287. Policy option No 2/5 is an issue apart. It addresses only the specific point of obligatory insurance/indemnity. It can offer synergies with policy options No 2/2 to 2/4. As shown above, policy option No 2/5 can be a useful tool to address the specific issue of obligatory insurance/indemnity. It greatly reduces the costs for indemnification by limiting contributions to the costs that actually occur: While, today costs for insurance/indemnification coverage are approximately 75m EUR per year, these costs would be limited to less than 1m EUR, thus addressing the concern of the very high insurance/indemnification coverage created by the Clinical Trials Directive. Policy option No 2/5 also greatly reduces the administrative costs and compliance costs for sponsors and yet provides protection for patients at least as strong and efficacious as the baseline option. These clear benefits of policy option No 2/5 come with the prize: Member States will have to set up a national indemnification mechanism which brings about complications and – in particular in the start-up phase – costs for resources. However, regarding these resources needs policy option No 2/5 allows for passing on the costs to the sponsors who benefit from the national indemnification mechanism. Even where these costs are passed on to the sponsor, policy option No 2/5 is still considerably cheaper than the baseline option. This policy option is therefore not only an effective, but also an efficient means to address the challenges in terms of costs and complexities for sponsors to ensure coverage of subjects in terms of compensation for damages.
288. Policy option No 2/6 combines the options No 2/4 and No 2/5. It brings about the savings of both policy options taken together while not compromising patient's rights and safety, and reliability of data generated in a clinical trial.

Overview — Impact of policy options to address objective No 2

	Contribution to addressing the problem (+++=very important contribution; ++=important contribution; +=some contribution; o=no contribution)	Health/social impact compared with baseline (+++=very positive impact; ++=positive impact; +=some positive impact; o=no impact; -=negative impact)		Economic impact/costs (in EUR) compared to baseline		Other comments
				Other compliance costs	Administrative costs	
Policy option No 2/1 (baseline)	(o)	(o)	Insurance/indemnity	0	0	
			ASR	0	0	
Policy option No 2/2 (enlargement of the scope of non-interventional trials)	(++)	(--)	Insurance/indemnity	- 4 m	- 0.12 m	Member States might again introduce regulation at national level (no level playing field).
			ASR	- 13.1 m	- 0.1 m	
Policy option No 2/3 (excluding "non-commercial sponsors")	(++)	(--)	Insurance/indemnity	- 14 m	- 0.5 m	See policy option No 2/2.
			ASR	- 59.9 m	- 0.44 m	
Policy option No 2/4 (removing requirements on the basis of the knowledge of the IMP)	(++)	(=)	Insurance/indemnity	- 7.8 m	- 0.25 m	
			ASR	- 26.1 m	- 0.2 m	
Policy option No 2/5 (insurance/indemnity)	(+++)	(++)	Insurance/indemnity	- 74.2 m	- 1.66 m	Implementation needs per year: 700 000 EUR (=10 FTEs) Damages to be paid per year: 135 000 EUR Synergies possible with policy options No 2/2 to No 2/4
Policy option No 2/6 (combination of policy option No 2/4 and 2/5)	(+++)	(++)	Insurance/indemnity	- 74.2 m	- 1.69m	As in policy option No 2/5
			ASR	- 26.1 m	- 0.2 m	

1.18. **5.3. Objective No 3: Addressing the global dimension of clinical trials when ensuring compliance with GCP**

1.1.37. Policy option No 3/1: Leaving the situation as it is (baseline option)

289. This policy option would not address the pressing questions raised under point 2.2.2. The existing measures have flaws which make it difficult to achieve the envisaged aim. In particular, the existing voluntary self-commitment by most sponsors to perform clinical trials in accordance with GCP does not necessarily give all the guarantees needed and is not enforceable. The same could be true, depending on the country, of the existing regulatory supervision and inspections by non-EU countries in their jurisdictions.

290. EU inspections are already performed in non-EU countries today, but only to a limited extent. Today, the EMA triggers, in the framework of the authorisation procedure of medicinal products, approximately 30 inspections outside the EU per year (see Annex 2). This rather limited activity is due to two factors:

- Resources: ‘Triggered inspections’ by the EMA are not performed by ‘EU staff’, but by the staff of NCAs of the Member States on behalf of the EU.¹⁴¹ For each inspection, the Agency has to enquire which Member States have resources available. However, resources in Member States are increasingly limited;
- *Ex-post* assessment: Inspections in non-EU countries suffer from one major limitation: they are performed years after the clinical trial has ended and thus limited to *ex-post* verification of archived documentation. This is less effective than inspection of an ongoing clinical trial.

1.1.38. Policy option No 3/2: Facilitating GCP inspections by increasing transparency

1.18.1.1.5.3.2.1. Social/health impact

291. This policy option would contribute to securing compliance with GCP with the aid of a stronger degree of transparency.

292. Only if it is publicly known that a clinical trial is in progress can the control mechanisms of competent authorities (be they in non-EU countries or in the EU) be effective: In particular, inspections of GCP compliance can only be conducted if information is available as to whether a clinical trial is ongoing in a given country or not.

293. Moreover, only transparency about the conduct of clinical trials can ensure effective scrutiny by media and civil society.

294. It is for this reason that, during both public consultations, all stakeholders supported this policy option.

1.18.1.2.5.3.2.2. Impact in terms of costs for sponsors

295. The impact on costs for sponsors will mainly be felt in the administrative costs for submitting information on clinical trials in non-EU countries to a public register.

¹⁴¹ Article 15(2) of Directive 2001/20/EC.

296. Details of these administrative costs are given in Annex 5. They total approximately 6.72 m EUR per year. These costs are administrative burdens, as they would not arise otherwise.

1.18.1.3.5.3.2.3. Implementation costs

297. Implementation costs would be minimal. As set out above, a publicly-accessible register for clinical trials exists already at EU-level. Allowing upload of information on clinical trials performed exclusively in third country is a very simple IT exercise.

1.1.39. Policy option No 3/3: Inspections of non-EU countries' regulatory systems for clinical trial

1.18.1.4.5.3.3.1. Social/health impact

298. This policy option would focus on the *system* of supervision of enforcement in non-EU countries. As a consequence, this policy option would not duplicate national/local inspection mechanisms in non-EU countries. In doing this, this policy option would contribute to securing compliance with GCP in clinical trials performed in non-EU countries.

1.18.1.5.5.3.3.2. Economic/resources impact

299. The main costs would stem from resource needs at EU level. To date, there are no such resources allocated at EU-level.

300. Annex 5 describes the resources required for 'system inspections' (see point 4.3.3), based on the experience in the food and veterinary sector, where a system similar to that put forward in this policy option exists (Food and Veterinary Office of the Commission, FVO). It shows that, to conduct approximately 8 system inspections per year of regulatory/supervisory systems, 3 inspector-FTEs plus 2 support-FTEs are needed. Additional implementation costs would be approximately 76 000 EUR.

301. For the purpose of this impact assessment it can be left open whether the inspection activity set out in this policy option would be allocated with the Agency (who has experience in coordinating GCP inspections in the context of the EU-wide marketing authorisation procedure) or with the Commission, who could draw on experiences from the area of food and veterinary control. This is a political decision to be taken at a later stage, to which the impact assessment report shall serve as an aid for decision making (see Annexes 5 and 8).

1.1.40. Policy option No 3/4: GCP inspections of non-EU countries' clinical trial sites

1.18.1.6.5.3.4.1. Social/health impact

302. This policy option would contribute to securing compliance with GCP in clinical trials performed in a non-EU country. However, it is not such a powerful tool as it might seem, mainly for the following reasons:

- Extent of clinical trial activity: As indicated in Annex 2, the majority of clinical trial results submitted in pivotal clinical trials in a marketing authorisation procedure stem from non-EU countries. Between 2005 and 2009, these pivotal clinical trials

were spread over 44034 sites in 89 countries.¹⁴² It is impossible to inspect all these sites regularly and systematically.

- Inspections are usually conducted in the context of the marketing authorisation procedure, i.e. many years after the clinical trial has ended. Because of this lapse in time it can in some cases be difficult to assess with certainty whether the clinical trial was conducted in accordance with GCP.

1.18.1.7.5.3.4.2. Economic/resources impact

303. The main costs would stem from resource needs for at EU level. As for 'system inspections' (see point 5.3.3), there is currently, at EU-level, no inspection capacity foreseen.

304. In view of the sheer number of clinical trial sites in third countries, a systematic inspection of all relevant clinical trial sites would be unfeasible. Therefore, it is assumed here that 10% of all clinical trial sites contained in pivotal clinical trials would be chosen for inspection on the basis of risk-criteria. Even in this case, however, resource needs would be in the range of 1 300 FTEs at EU-level (see Annex 5).

1.1.41. Policy option No 3/5: Combination of policy options No 3/2 and 3/3

1.18.1.8.5.3.5.1. Social/health impact

305. The combination of policy options No 3/2 and No 3/3 would have a further strengthen the favourable impact on GCP compliance in clinical trials performed in non-EU countries. This is because the transparency (policy option No 3/2) as to where clinical trials relevant for the EU are conducted allows targeting inspections on non-EU countries' regulatory systems.

1.18.1.9.5.3.5.2. Economic/resources impact

306. The impact in terms of costs and resources is the cumulative impact of policy options No 3/2 and 3/3.

1.1.42. Comparison of policy options for objective No 3 and synergies, subsidiarity

307. The foregoing shows that policy option No 3/1 is not satisfactory: it would not address the problem identified under point 2.2.3.

308. Regarding policy options No 3/3 and No 3/4, both have relatively similar effects in terms of achieving the objective, even though the approach is different. Their impact diverges considerably as regards the impact on resources at EU level. Regarding policy option No 3/4, the budgetary cuts, in particular in personnel at EU level (both the Commission and the Agency), do not allow, at present, an increase in inspection activity in line with policy option No 3/4. The assessment of the impact of policy option No 3/3 shows that much can be achieved with far fewer resources than specified in policy option No 3/4.

¹⁴² Cf. presentation by Mr F. Sweeney, EMA, at the international workshop on a draft reflection paper on ethical and GCP aspects of clinical trials of medicinal products for human use conducted in third countries and submitted in marketing-authorisation applications to the EMA, 6-7 September 2010, London.

309. Policy options No 3/3 and 3/4 are not per se mutually exclusive: One could conduct inspections of regulatory systems *and* inspections of trial sites. However, there are, in practice, resources limitations which would not allow a cumulative application of both policy options: The resources available at EU level would not allow the effective conduct of both activities in parallel.
310. Therefore, while these two policy options do not exclude each other in theory, in view of the limited resources they cannot apply, in practice, cumulatively.
311. Policy option No 3/2 can make a useful contribution to effective control over clinical trials performed in non-EU countries. The burden for the sponsor, which is limited to administrative costs, is acceptable in view of the benefits created by this policy option.
312. Policy option No 3/5 combines policy options No 3/2 and No 3/3: This combination of policy options is preferable as it strengthens further the favourable impact of policy option No 3/3. In terms of subsidiarity considerations, the preferable policy option No 3/5 is based on the exercise of a shared competence provided for in the TFEU to regulate the conduct of clinical trials. As set out above (point 2.3), this competence has been exercised by the Union legislator and consequently Member States are not allowed to add on these rules. This also holds for the rules as to whether data generated in clinical trials is acceptable in the context of authorisation of a clinical trial in the EU or authorisation of a medicinal product authorised in the EU. Policy option No 3/5 addresses this point: The data submitted in the EU has to stem from clinical trials which are conducted in accordance with GCP, and which are publicly registered.

Overview — Impact of policy options to address objective No 3

	Contribution to addressing the problem (+++=very important contribution; ++=important contribution; +=some contribution; o=no contribution)	Health/social impact compared with baseline (+++=very positive impact; ++=positive impact; +=some positive impact)	Economic impact/costs compared with baseline	Other comments
Policy option No 3/1 (baseline)	(o)		n/a	
Policy option No 3/2 (increased transparency on GCP/ obligation of registration for all CT)	(++)	(++)	Additional administrative burdens for sponsors: 6.72 m EUR	Synergies possible with policy options No 3/3 and 3/4
Policy option No 3/3 (Inspections of regulatory systems in third countries)	(++)	(++)	Additional resource needs at EU level: 5 FTEs, 76 000 EUR	
Policy option No 3/4 (GCP sites inspections in non-EU countries)	(++)	(++)	Additional staff needs at EU level: 1300 FTEs	
Policy option No 3/5 (Combination of policy options No 3/2 and No 3/2)	(++)	(+++)	Cumulative impact of policy options No 3/2 and No 3/2	

6. CONCLUSION — FINAL CHOICES OF POLICY OPTIONS — OVERVIEW

1.19. 6.1. Final choices of policy options

313. Comparison of the impact of the policy options in Chapter 5 leads to the following conclusions:

314. Concerning **objective No 1**, the comparison in point 5.1.6 shows that the baseline option No 1/1 is insufficient. Comparing policy options No 1/2 (single submission with separate assessment) to No 1/4 (single submission with central assessment by the Agency), policy option No 1/3 (single submission with joint MS assessment) has the best arguments on its side: it reduces the administrative costs by over 270m EUR.

These costs are all administrative burdens. Moreover, this policy option leads to a fast approval procedure without recourse, as in policy option No 1/4, to complex approval infrastructure at EU level, which would increase costs and delays and would be too burdensome especially for academic research. Moreover, the ‘institutional continuum’ between trial approval and medicines approval would pose the risk that clinical trials could be approved on the basis of data desirable for marketing authorisation, rather than from the point of view of the benefits and risks to the subject. Policy option No 1/5 is very effective and has particular benefits if it is applied, as in policy option No 1/6, as an add-on to policy option No 1/3 in order to streamline approval procedures.

315. Concerning **objective No 2**, the comparison in point 5.2.7 shows that excluding ‘non-commercial’ sponsors from the scope of EU regulation of clinical trials (policy option No 2/3) would be the wrong approach. Equally, reducing the scope of EU regulation (policy option No 2/2) would be counter-productive, as clinical trials excluded from the scope of EU law would be regulated at national level, which runs counter to the interests of public health and sponsors. Instead, policy option No 2/4 (removing requirements on the basis of the knowledge of the IMP) offers a viable solution to achieve objective No 2 without compromising public health, patient safety or harmonisation efforts at EU level. For the specific topic of obligatory insurance/indemnity, policy option No 2/5 is very effective as an add-on measure in order to achieve objective No 2. In view of this, a policy option No 2/6 combining policy options No 2/4 and 2/5 is best achieving the objective No 2.

316. Concerning **objective No 3**, as indicated in point 5.3.6, some of the policy options can be added together and are not mutually exclusive. When assessing the options, costs must be considered which could affect not only sponsors and investigators, but also EU institutions (the Commission or the Agency) and thus, indirectly, the European taxpayer or sponsors as fee-payers. The conclusion is that, by joining policy options No 3/2 (increased transparency on GCP/ obligation of registration for all CT) and 3/3 (Inspections of non-EU countries' regulatory systems for clinical trials) together, the objective can be achieved reasonably well without recourse to policy option No 3/4 (GCP inspections in non-EU countries' clinical trial sites). In view of the mutually-strengthening effect, a policy option No 3/5, combining policy options No 3/2 and 3/3, is the best way to achieving objective No 3.

1.20. 6.2. Final overview

Overview of the impact of the final policy choices

Chosen policy options No	Contribution to addressing the problem (+++ = very important contribution; ++ = important contribution)	Health/social impact (+++ = very positive impact; ++ = positive impact)	Economic impact/costs compared with baseline (in EUR)		Other comments (including implementation costs)
			Other compliance costs	Administrative burdens	
1/6 (single submission with joint MS assessment & Regulation)	(+++)	(+++)	- 440 m	- 271.7 m	<u>Single submission point:</u> <u>One-off:</u> between 1.62m (limited IT solution) and 6.3m (extensive IT solution) <u>Running:</u> between 0.34m (limited IT solution) plus 0.25 FTEs and 1.26m plus 19 FTEs (extensive IT solution)

					<u>Additional support staff needed:</u> 1.75 or 7 FTEs (depending on choice for limited or extensive support structure)
2/6 (removing requirements on the basis of the knowledge of the IMP & insurance /indemnity mechanism)	(++)	(++)	- 100.3 m	- 1.89 m	-
3/5 (increased transparency on GCP/ obligation of registration for all CT & system inspections)	(++)	(++)	-	+ 6.72 m	Additional resource needs at EU level: 5 FTEs, 76 000 EUR

7. MONITORING AND EVALUATION

317. Once adopted, implementation and compliance of Member States with the revised legislation is going to be **monitored** under the auspices of the Pharmaceutical Committee. In accordance with the Council Decision establishing the Pharmaceutical Committee,¹⁴³ this body is tasked to examine any question relating to the application of Directives on medicinal products which are put forward. To this end, the Pharmaceutical Committee is composed of senior experts of the competent authorities of all Member States.

318. **Evaluation** of the impact of the revised legislation is going to be based, in accordance with the operational objective set out above (point 3) on the following criteria:

- Development of the number of clinical trials applied for in the EU, as well as the number of clinical trial participants; and
- Development of the number of multinational clinical trials applied for in the EU.

319. Both impact indicators will be retrieved on a regular basis from the single EU Portal (see point 4.1.3), which is going to hold this information. A compilation of these data is going to be published on a yearly basis.

320. Moreover, evaluation of the impact is going to assess the following criteria:

¹⁴³ Council Decision 75/320/EEC of 20 May 1975 setting up a pharmaceutical committee, OJ L 147, 09.06.1975, p. 23.

- Development of the delays between finalisation of the protocol and 'first patient in';
 - The development of administrative costs presenting administrative burdens, and of other compliance costs of clinical trials conducted in the EU; and
 - Trends in conducting clinical trial outside the EU for generating data referred to in the request for authorisation of a clinical trial or a medicinal product.
321. For the purpose of this evaluation, the Commission continues to be in constant contact with stakeholders associations (industry and non-commercial sponsors) through attending workshops and other relevant events.
322. The impact indicator "compliance with GCP of clinical trials conducted in non-EU countries" is going to be measured through periodic evaluation of the results from inspections referred to in policy option No 3/3.
323. The information gathered from these sources is going to be compiled in a comprehensive interim evaluation which will be made available to the public five years after the date of application of the revised legislation.
324. This comprehensive interim evaluation shall serve as basis for a stakeholder meeting similar to the Commission/Agency clinical trial conference, organised by the Commission is envisaged. In addition, a public consultation is going to be held.
325. On the basis of these additional findings a final evaluation report is going to be published seven years after the date of application of the revised legislation.