



Council of the
European Union

Brussels, 20 December 2018
(OR. en)

5814/4/18
REV 4

FISC 44
ECOFIN 75

NOTE

From: General Secretariat of the Council
To: Delegations

Subject: Agreed guidance by the Code of Conduct Group (business taxation): 1998-2018

Delegations will find in annex the compilation of the Guidance notes agreed by the Code of Conduct Group (business taxation) since its creation in March 1998.

Table of Contents¹

GUIDANCE ON ROLLBACK AND STANDSTILL	4
GUIDANCE ON EXCHANGE OF INFORMATION IN INDIVIDUAL CASES ARISING FROM THE CODE OF CONDUCT GROUP'S WORK ON TRANSPARENCY AND EXCHANGE OF INFORMATION IN THE AREA OF TRANSFER PRICING.....	11
PROCEDURAL ISSUES: GENERAL GUIDING PRINCIPLES CONCERNING EVALUATION OF MEASURES.....	14
GUIDANCE ON THE IDENTIFICATION OF HARMFUL RULINGS	21
GUIDANCE ON IMPROVEMENTS IN THE FIELD OF TRANSPARENCY.....	22
GUIDANCE ON THE IDENTIFICATION OF HARMFUL RULINGS	23
GUIDANCE ON INBOUND PROFIT TRANSFERS	25
GUIDANCE ON PROFIT PARTICIPATING LOANS	26
GUIDANCE ON INTERMEDIATE FINANCING OR LICENSING ACTIVITIES	27
MODEL INSTRUCTION FOR THE SPONTANEOUS EXCHANGE OF INFORMATION ON ADVANCE INTERPRETATIONS OF LEGAL PROVISIONS IN CROSS-BORDER SITUATIONS ("RULINGS").....	29
GUIDANCE ON HYBRID ENTITY MISMATCHES CONCERNING TWO MEMBER STATES	39
GUIDANCE ON HYBRID PERMANENT ESTABLISHMENT MISMATCHES CONCERNING TWO MEMBER STATES.....	48
GUIDANCE ON MODIFIED NEXUS APPROACH FOR IP REGIMES.....	56
GUIDANCE ON HYBRID ENTITY MISMATCHES CONCERNING A MEMBER STATE AND A THIRD STATE	59
GUIDANCE ON HYBRID PERMANENT ESTABLISHMENT MISMATCHES CONCERNING A MEMBER STATE AND A THIRD STATE	68
GUIDELINES ON THE CONDITIONS AND RULES FOR THE ISSUANCE OF TAX RULINGS – STANDARD REQUIREMENTS FOR GOOD PRACTICE BY MEMBER STATES	80
PROCEDURAL ISSUES: GUIDANCE ON THE NOTIFICATION OF TAX MEASURES UNDER PARAGRAPH E OF THE CODE.....	84
PROCEDURAL ISSUES: GUIDANCE ON THE PROVISION OF INFORMATION IN THE REVIEW PROCESS.....	90
GUIDELINES FOR THE PROCESS OF SCREENING OF JURISDICTIONS WITH A VIEW TO ESTABLISHING AN EU LIST OF NON-COOPERATIVE JURISDICTIONS FOR TAX PURPOSES	93
GUIDANCE ON TAX PRIVILEGES RELATED TO SPECIAL ECONOMIC ZONES	96
GUIDANCE ON THE INTERPRETATION OF THE FOURTH CRITERION OF THE CODE OF CONDUCT FOR BUSINESS TAXATION.....	97

¹ The guidance notes are listed in chronological order

PROCEDURAL ISSUES: GUIDELINES ON SETTING WORKING METHODS FOR AN EFFECTIVE MONITORING OF MEMBER STATES' COMPLIANCE WITH AGREED GUIDANCE	100
DEFENSIVE MEASURES	105
CRITERION 1.3 (THE DURATION OF THE REASONABLE TIMEFRAME)	111
SCOPE OF CRITERION 2.2.....	113
PROCEDURAL GUIDELINES FOR CARRYING OUT THE PROCESS OF MONITORING COMMITMENTS CONCERNING THE EU LIST OF NON-COOPERATIVE JURISDICTIONS FOR TAX PURPOSES	122
GUIDANCE ON THE INTERPRETATION OF THE THIRD CRITERION OF THE CODE OF CONDUCT FOR BUSINESS TAXATION	125
BEPS MINIMUM STANDARDS IMPLEMENTATION: AGREED BENCHMARKS	133
GUIDANCE ON CRITERION 3.2 OF THE EU LISTING EXERCISE.....	137

GUIDANCE ON ROLLBACK AND STANDSTILL²

1. The purpose of this guidance is to assist Member States in achieving in the 3 areas of finance branches, holding companies and headquarter companies a balanced approach in comparable situations to standstill and to rollback of measures which the code of conduct group has found to be harmful as contained in the report of the code of conduct group of 23 November 1999 (SN 4901/99) as submitted to the ECOFIN Council on 29 November 1999.
2. The code sets out the criteria agreed unanimously by ECOFIN for determining whether or not a measure is harmful, and final evaluation of whether or not the rollback and standstill conditions in the code are satisfied must therefore be made against the criteria in the code itself. The guidance does not replace the code and does not re-open or bring into question the assessments made by the Group.
3. The Council and the representatives of the governments of the Member States, meeting within the Council, agreed on the scope and coverage of the code of conduct and established the criteria on which the group should base its assessment of tax measures in the following terms:

A. Without prejudice to the respective spheres of competence of the Member States and the Community, this code of conduct, which covers business taxation, concerns those measures which affect, or may affect, in a significant way the location of business activity in the Community.

Business activity in this respect also includes all activities carried out within a group of companies.

The tax measures covered by the code include both laws or regulations and administrative practices.

² Endorsed by the Council in its conclusions on the tax package (doc. 13898/00 FISC 207). A number of delegations (the Netherlands, Belgium and Ireland) made statements in the minutes in relation to paragraph 18.

B. Within the scope specified in Paragraph A, tax measures which provide for a significantly lower effective level of taxation, including zero taxation, than those levels which generally apply in the Member State in question are to be regarded as potentially harmful and therefore covered by this code.

Such a level of taxation may operate by virtue of the nominal tax rate, the tax base or any other relevant factor.

When assessing whether such measures are harmful, account should be taken of, inter alia:

- 1. whether advantages are accorded only to non-residents or in respect of transactions carried out with non-residents, or*
- 2. whether advantages are ring-fenced from the domestic market, so they do not affect the national tax base, or*
- 3. whether advantages are granted even without any real economic activity and substantial economic presence within the Member State offering such tax advantages, or*
- 4. whether the rules for profit determination in respect of activities within a multinational group of companies departs from internationally accepted principles, notably the rules agreed upon within the OECD, or*
- 5. whether the tax measures lack transparency, including where legal provisions are relaxed at administrative level in a non-transparent way.*

4. The code adds:

C. Member States commit themselves not to introduce new tax measures which are harmful within the meaning of this code. Member States will therefore respect the principles underlying the code when determining future policy and will have due regard for the review process referred to in paragraphs E to I in assessing whether any new tax measure is harmful.

D. Member States commit themselves to re-examining their existing laws and established practices, having regard to the principles underlying the code and to the review process outlined in paragraphs E to I. Member States will amend such laws and practices as necessary with a view to eliminating any harmful measures as soon as possible taking into account the Council's discussions following the review process.

5. Paragraph H of the code states that the code of conduct group (business taxation) will *select and review the tax measures for assessment in accordance* with the provisions laid down in paragraphs E to G of the code.

6. Paragraph F requires that the assessment will take account of all the factors identified in paragraph B and paragraph G emphasises the need to evaluate carefully in that assessment the effects that the tax measures have on other Member States *inter alia* in the light of how the activities concerned are effectively taxed throughout the Community.

7. Paragraph G also states that Insofar as the tax measures are used to support the economic development of particular regions, an assessment will be made of whether the measures are in proportion to, and targeted at, the aims sought. In assessing this, particular attention will be paid to special features and constraints in the case of the outermost regions and small islands, without undermining the integrity and coherence of the Community legal order, including the internal market and common policies.

8. The group presented a report SN 4901/99 to the ECOFIN Council on 29 November 1999 setting out its assessment of 271 measures which it had evaluated against the criteria in the code. This report was agreed by the Group subject to reservations, set out in footnotes, by some delegations. The conclusions of the ECOFIN Council meeting on 17 July 2000 confirmed the continuation of the work programme of the Code of Conduct Group in line with the conclusions of the European Council at Santa Maria da Feira on 19-20 June, calling on the Code of Conduct Group (Business Taxation) to continue its proceedings with determination and to report to the Council by the end of the year on the progress achieved.
9. Rollback of a measure that the group has found to be harmful may take the form either of :
 - abolition of the measure; or
 - removal of the harmful features of the measure.
10. Standstill means not introducing a new or replacement measure that contains harmful features.
11. The features set out below have led to measures in the areas of finance branches, holding companies and headquarter companies being evaluated as harmful under the criteria in the code. Under rollback, Member States will either have to abolish such measures that have been found harmful, or remove from the measures the harmful features listed below. Under standstill, Member States have to refrain from introducing new or replacement measures that contain such harmful features.
12. The features listed below do not replace the criteria set out in the code. They are features that the code of conduct group has taken into account in evaluating whether measures are harmful under the criteria in the code. The final evaluation of whether or not the rollback and standstill conditions are satisfied must be made against the criteria in the code itself.

13. Transparency and exchange of information are guiding principles. In accordance with the principles of transparency and openness and having regard to paragraphs E and I of the code Member States will inform each other and the Commission of existing and proposed tax measures which may fall within the scope of the code. Where envisaged tax measures need parliamentary approval, such information need not be given until after their announcement to Parliament. In accordance with paragraph B5 of the code, particular reference should be made to whether measures lack transparency or are relaxed at administrative level in a non-transparent way. A measure will satisfy the criterion at B5 if details of the existence, scope and conditions of the measure are not published.
14. Regard should also be made to paragraphs E and K of the code in respect of the provision and exchange of information.
15. Paragraph E states that In accordance with the principles of transparency and openness Member States will inform each other of existing and proposed tax measures which may fall within the scope of the code. In particular, Member States are called upon to provide at the request of another Member State information on any tax measure which appears to fall within the scope of the code. Where envisaged tax measures need parliamentary approval, such information need not be given until after their announcement to Parliament.
16. Paragraph K records that The Council calls on the Member States to cooperate fully in the fight against tax avoidance and evasion, notably in the exchange of information between Member States, in accordance with their respective national laws.

17. In relation to transparency and the provision and exchange of information concerning transfer pricing, regard should also be had, in accordance with paragraph B4 of the code, to the OECD's Transfer Pricing Guidelines and, in particular, to Chapter 4 of the Guidelines ("Administrative approaches to avoiding and resolving transfer pricing disputes"). Member States shall inform each other yearly about the use of the transfer pricing guidelines in practice and the number and kind of Advance Pricing Arrangements concerning transfer pricing. Information on procedures regarding Advance Pricing Arrangements should be exchanged as well among Member States. If a Member State has agreed to an Advance Pricing Arrangement, ruling or any other advance agreement concerning transfer pricing, it should automatically notify all other Member States concerned and provide them with all necessary information. The same principle should apply to Member States when after either an application or on examination they become aware that a company has used a transfer pricing method that is outside the OECD transfer pricing guidelines. Member States should inform the Member States concerned of any such discrepancies.
18. The features that the Group took into account when evaluating whether the measures it assessed in the areas of finance branches, holding companies and headquarter companies were harmful are:

Finance Branches:

- (i) The measure permits the profits to be allocated between a Head Office and a branch at less than an arm's length rate. This may arise for instance where the allocation is permitted to be made in a formulaic way.
- (ii) Exemption of branch profits by the country of the Head Office in cases where:
 - (a) the level of taxation in the country of the branch is significantly lower than in the country of the Head Office; and
 - (b) the profits have not been subject to effective anti-abuse or countermeasures which in paragraph L of the code the Council notes play a fundamental role in counteracting tax avoidance and evasion.

Holding Companies:

- (iii) Exemption of foreign source dividends in circumstances in which the profits giving rise to the dividends:
 - (a) have been taxed at a significantly lower level in the source country than they would have been if they had arisen in the Member State; and
 - (b) have not been subject to effective anti-abuse or countermeasures which in paragraph L of the code the Council notes play a fundamental role in counteracting tax avoidance and evasion.
- (iv) Asymmetrical measures where capital gains are exempt but capital losses are tax deductible.

Headquarter Companies:

- (v) Determination of profits other than in accordance with the OECD's Transfer Pricing Guidelines.
- (vi) In particular, use of cost plus and resale minus methods of determining arm's length profits when some or all of the following apply:
 - (a) the methods are used in circumstances where a comparable uncontrolled price might reasonably be obtained;
 - (b) it is not clear that there is always an individual examination of the underlying facts of the particular case or that the mark-up or margin is reviewed regularly against normal commercial criteria;
 - (c) the advantages are restricted in accordance with paragraphs B1 or B2 of the code;
 - (d) there is a reduction in the expense base taken into account for the purposes of determining taxable income.

GUIDANCE ON EXCHANGE OF INFORMATION IN INDIVIDUAL CASES ARISING FROM THE CODE OF CONDUCT GROUP'S WORK ON TRANSPARENCY AND EXCHANGE OF INFORMATION IN THE AREA OF TRANSFER PRICING³

a) The circumstances in which information will be exchanged

The aim of exchanging information on transfer pricing must be to allow the Member States concerned to determine the correct assignment of tax bases in their respective jurisdictions. Unilateral Advance Pricing Arrangements (APAs), rulings or any other advance agreements concerning transfer pricing (hereafter commonly referred to as APAs) may encourage under-taxation not in accordance with the arm's length principle, or concern on the part of other Member States that such under-taxation exists and is not transparent.

Therefore, if a Member State has agreed to a unilateral APA, ruling or any other advance agreement concerning transfer pricing, it is important that the Member State spontaneously notify any tax administration, which is directly concerned in respect of information which appears relevant for the correct assessment of taxes on income and capital. A directly concerned Member State is a Member State, where one of the related parties that are engaged in a transaction covered by the agreement, is a resident or carries on business through a permanent establishment.

APAs can also be bilateral or multilateral. In cases where all tax administrations concerned are involved in the APA, information will be exchanged as part of the cooperation. However, there might be cases where tax administrations, which are not participating in the bilateral or multilateral APA, are directly concerned by the agreement. In these cases the Member States involved in the APA should make a spontaneous notification to those administrations concerned.

³ Endorsed by the Council on 3 June 2003 (annex of doc. 10126/03 FISC 93)

b) The kind of information that will be exchanged

The exchange of information procedure should be divided into two steps.

First, the tax administration involved in the APA should make a notification to the Member State affected by the agreement. The notification shall consist of either the full APA or a summary of the agreement (including notably the information necessary for the identification of the tax payers engaged in transactions covered by the agreement, the type of transactions, the methodology applied and its justification as well as the accounting periods affected and the conditions or modalities for its revision or annulment, where applicable)

At the latest the notification shall be made as swiftly as possible after the conclusion of the APA.

Secondly, the Member State granting the APA should , upon request, provide all the further relevant information about the transactions covered by the APA.

The Directive 77/799/EEC on Mutual Assistance applies to the exchange of information, whether it is exchange of information in step one or two. If the relevant Double Taxation Convention or national law provides for a more extensive exchange of information, the Member States can exchange more information.

c) How to guarantee the confidentiality of the information

The confidentiality of the information exchanged is one of the main concerns of the tax administrations. The Directive 77/799/EEC on Mutual Assistance applies to the exchange of information. Therefore the confidentiality of the information exchanged is protected under the terms of Article 7 of the Directive.

In addition to the Mutual Assistance Directive, confidentiality can be legally guaranteed by means of

- National provisions or national law: national law usually includes clauses aimed at guaranteeing the confidentiality of the tax information to which the bodies of the tax administrations have access in the course of their duties. Those provisions also usually lay down that such information may only be used for tax purposes. In that regard, confidentiality is guaranteed if the information obtained by means of exchanges is also considered to be protected by such confidentiality and exclusive use clauses.

- Agreements: the confidentiality of the information exchanged is expressly protected under the terms of the article on exchange of information in the relevant double taxation treaty.

The requirement of confidentiality of the information received from other administrations must cover the entirety of that information.

d) How to implement the principle of reciprocity

The principle of reciprocity is a general principle governing the exchange of information, which also should be respected in this specific area.

However, in order to prevent such a principle from constituting an unwanted restriction to the exchange of information and being the object of abuse, resulting in unwanted delays, the principle should be interpreted in a sufficiently broad manner. A Member State that does not enter into APAs, rulings or any other advance agreements concerning transfer pricing should also receive information.

PROCEDURAL ISSUES: GENERAL GUIDING PRINCIPLES CONCERNING EVALUATION OF MEASURES⁴

- In order to build on the framework of the Code of Conduct and increase transparency, all new evaluations of the Code Group will have to be sufficiently substantiated taking into consideration all Code criteria, stating arguments and providing data where possible, while remaining within the mandate of the Code Group. The guiding principles for all evaluations are that they will take place on a case-by-case basis and take account of objective economic factors and impact data, and that they are carried out with a view to avoiding discrimination between Member States, so that similar cases will not be treated differently. This elaborated evaluation can then be used for future reference in case a MS claims precedence. As far as assessing criterion 1b is concerned, and without prejudice to the criteria in the Code, the Group will consider any economic factor and impact data that are brought to its attention. The Group will consider size and openness in order to ensure that there is no discrimination between Member States. Equally, it will not use these factors in a way which discriminates against larger or less open Member States. Together with size and openness the Group will consider other relevant factors, such as the transparency of the tax system and the significance of the economic effect on other Member States, in a similarly full and balanced way.
- Furthermore, the development or revision of guidance notes (e.g. on holding company regimes, R&D / royalty tax incentives and other regimes leading to a lower level of taxation) could help build on the results of the Group.
- In case a measure has been approved by the Group, the approval of this measure should not preclude a possible future reassessment of this measure in exceptional circumstances (after a reasonable timeframe and after MS's indications that their tax bases are significantly affected by this measure). Such reassessment will start only at the invitation of ECOFIN on the basis of an analysis of the facts made by the Group.

The Group accepts that the Code assessments are not an exact science. In case of conflict of opinions, a more political discussion on precedence (or any other matter) cannot always be avoided.

⁴ Agreed by the Group in November 2008 (doc. 16084/08)

1. Role of precedence and comparability

1.1. Guiding principles concerning 'Precedence'

- While each measure should be assessed on its merits under the peer review process, precedence has in the past and should in the future play a role in the Code of Conduct procedure. The claim for precedence as well as its assessment should be made in a transparent manner.
- The Group will take the following approach if a Member State (MS1) claims precedence on the basis of a regime of another Member State (MS2):
 - i) MS1 is required to provide a written document substantiating the claim for precedence, based on factors such as scope, design and general tax environment and (actual or estimate) data on the impact of the regime.
 - ii) the Group will compare the regimes of MS1 and MS2. In this respect a comparability table (as suggested in Annex 1) can be used as tool to structure and focus the discussion.
 - iii) in case the regime of MS2 was approved by the Group in the past with question marks on criteria 1b and 2b, MS2 can be requested to provide new information on economic impact in case these data are relevant for comparing them with MS1 economic data. MS 2 regime will not be automatically re-evaluated.

1.2. Guiding principles concerning 'Comparability':

- A comparison of tax measures should be based on the characteristics of the measure which are relevant from a Code of Conduct perspective.
- In order to enable the Group to make a relevant comparison between tax measures a table (as suggested in Annex 1) can be used as a tool to specify the comparables in cases of claims for precedence. As preliminary remarks:

- the elements in the table should not be used as a cumulative requirement list since requiring 100% comparability would undermine and erode the principle of precedence and equal treatment;
- the left column of the comparability table contains a full list of the elements derived from the Code of Conduct that are relevant in the comparison. The list of comparables, in the right column of the table, sets out factors which may be considered relevant for the Code of Conduct but is in principle non-exhaustive;
- 'type of income' is a relevant comparable since the Code focuses on measures that affect the location of business activities. The Group could consider that if a measure targets a type of income which is relatively mobile, one could argue that the measure is more likely to affect the location of business activities than a measure that targets a less mobile type of income (determined on the basis of the actions needed and risks run by relocating the underlying asset or activity that generates the income or the possibilities to re-route a flow of income from the companies actually paying the income). On the basis of the measures the Group reviewed in the past, the Group could try and develop a table to be used as a more detailed comparability tool.

2. Procedure

- The procedures in question relate to the way conclusions are reached in the Code of Conduct Group. In this context, the Group should maintain to aim at a (broad) consensus to reflect the MSs positions in the Code of Conduct Group in future reports to ECOFIN, to avoid loosing the effectiveness of the Code Group, while respecting the principle of unanimity as laid down in paragraph 14 of the Council conclusions concerning the establishment of the Code of Conduct Group (9 March 1998, 98/C99/01).
- Therefore, the Group considers that the Code of Conduct reports to ECOFIN can still use the terms 'the Group' and 'broad consensus':
 - in the case that all MSs (minus the one MS concerned) share an opinion;
 - in other cases where MSs, other than the MS concerned, have a dissenting opinion, and none of these MSs oppose the use of the wording 'the Group' and 'broad consensus' (e.g. in case MSs might technically object to an evaluation of a measure but do not politically object to the end result of the Group at ECOFIN level).

- In case the Group does not reach 'broad consensus', the Chair will consider calling for an additional Code of Conduct Group meeting where all MSs will be urged to participate at high level (political) as is foreseen in paragraph 11 of Council Conclusions concerning the establishment of the Code of Conduct Group (9 March 1998, 98/C 99/01), with the aim of having a more political discussion (and perhaps solve any problem that the Group could not solve on a more technical level). Such a Code Group meeting could also address more general Code issues, not specifically relating to a measure, in preparation for the ECOFIN Council.
- In case “broad consensus” can’t be reached, the report to ECOFIN can then express the various views mentioned, indicating the number of MSs concerned without qualifying their views, and be edited in such way that ECOFIN can have a clear and focussed discussion on the key elements at stake.
- In order to raise more awareness of the Code of Conduct at the level of Ministers and our present work, an ECOFIN Council meeting with the Code on the agenda could be used to re-affirm the commitment of all MSs to combat harmful tax competition and make clear that in future more discussions will follow at ECOFIN (whereas in the past most Code reports passed as a I/A item).

3. Situations where measures are affected by State aid proceedings

- Paragraph J of the Code states that some of the tax measures covered by this code may fall within the scope of the provisions on State aid. However, the paragraph does not provide any procedure for the fact that both State aid proceedings and Code of Conduct discussions can take place in ‘parallel’.
- In cases where a measure is part of an ongoing State aid procedure (after the formal opening of the State aid procedure), the Group will suspend the Code of Conduct discussion until the Commission's State aid procedure has taken its course. A preliminary description of the measure, drafted by the Commission in close consultation with the MS concerned, can already be provided to the Group. A final (possibly revised) version of a description should be provided immediately after the end of the State aid procedure, if need be.

- The Group should be reminded that a Code of Conduct evaluation is not necessarily the same as a Commission State aid decision (or vice versa). The two procedures are separate and follow their own set of rules and criteria. MSs should therefore explicitly recognize that a COM State aid decision does not affect the outcome of a Code of Conduct evaluation (and vice versa).
-

ANNEX

Code of Conduct comparability table

	Code of Conduct elements	Comparables
A	Affects business location	<p>Which type of business or income is covered by the regime?</p> <p>Does the measure attract genuine economic business or artificially shiftable mobile tax bases?</p> <p>Attraction of tax bases of other MSs? Can the tax base easily be shifted (mobility)?</p> <p>Is the measure targeted at MNEs (intra group)?</p>
B	Lower level of taxation	Design of the reduction of the tax base or rate
1a	Benefits accorded to non-residents or transactions with non-residents	To what extent does the measure, de jure, benefit foreign-owned companies.
1b	De facto	<p>To what extent does the measure, de facto, benefit foreign-owned companies.</p> <p>Impact assessment required, economic effects. (e.g. number of foreign owned companies benefiting as a percentage of total companies benefiting) (Without prejudice to the criteria in the Code, the Group will consider any economic factor and impact data that are brought to its attention. The Group will consider size and openness in order to ensure that there is no discrimination between Member States. Equally, it will not use these factors in a way which discriminates against larger or less open Member States. Together with size and openness the Group will consider other relevant factors, such as the transparency of the tax system and the significance of the</p>

		economic effect on other Member States, in a similarly full and balanced way).
2a	Protection of the tax base	Does the measure affect the domestic tax base? Is the domestic tax base protected in any way? If yes, in which form?(e.g. no domestic companies allowed or limitation of deductibility of transactions with domestic companies).
2b	De facto	To what extent (budgetary) is the domestic tax base protected? Impact assessment needed, economic effects
3	Substance	Which substance requirements are in place? Personnel, investments in fixed assets, other.
4	Profit determination (transfer pricing)	OECD Transfer Pricing Guidelines - fixed margins vs case by case approach - periodical review of the transfer price - exchange of information
5	Transparency	Procedure for granting of the benefits (discretionary powers?)
C	Other elements:	Such as general tax environment, to the extent that it is relevant for the measure under consideration. (e.g. general tax rate, deviation of the incentive from the general tax rate, historic context of the tax measure which is used for the claim of precedence, or how the activities concerned are effectively taxed throughout the Community (paragraph G of the Code))

GUIDANCE ON THE IDENTIFICATION OF HARMFUL RULINGS

Rulings concern the advance interpretation or application of tax provisions by the tax administration to a specific fact pattern of a specific taxpayer.

With respect to the *identification of harmful rulings*, the Group agreed on 22 November 2010 (doc. 16766/10) the following guidance:

- *In order to start a review process with respect to administrative practices, MSs are invited to share with the Group their knowledge or suspicion about harmful administrative practices of other Member States.*
- *The criteria for assessing the harmfulness of an administrative practice are the five criteria for harmfulness as laid down in Paragraph B of the Code of Conduct.*

GUIDANCE ON IMPROVEMENTS IN THE FIELD OF TRANSPARENCY

With respect to improvements in the field of transparency, the Group agreed on 25 May 2010 (doc. 10033/10) the following guidance:

- *To the extent that a MS accommodates the advance interpretation or application of a legal provision to a specific situation or transaction of an individual taxpayer, the underlying procedures should be embedded in a transparent legal and administrative framework, that is public legislation or administrative guidelines.*
- *Where the advance interpretation or application of a legal provision to a specific situation or transaction of an individual taxpayer is suitable for horizontal application in similar situations, this interpretation or application should be published or be reflected in updated guidance, or be made otherwise publicly available.*

GUIDANCE ON THE IDENTIFICATION OF HARMFUL RULINGS

With respect to *improving exchange of information for cross border rulings*, the Group agreed on 22 November 2010 (doc. 16766/10) the following guidance:

- *If a Member State (MS) provides advance interpretation or application of a legal provision for a cross border situation or transaction of an individual taxpayer (hereafter: cross border ruling), which is likely to be relevant for the tax authorities of another Member State, the tax authorities of the first Member State will spontaneously exchange the relevant information regarding this cross border ruling in accordance with the provisions of the Directive on Mutual Assistance with the latter Member State in order to assure coherent overall taxation.*
- *By means of a non-exhaustive list, this would specifically concern the following types of cross border rulings:*
 - o *MS 1 gives clearance on the absence of a PE in MS 1 to a company resident in MS 2. Such a ruling could be relevant for the tax authorities of MS 2 (same applies in reverse situation).*
 - o *MS 1 gives clearance on specific items related to the tax base of a PE in MS 1 to a company resident in MS 2. Such a ruling could be relevant for the tax authorities of MS 2 (same applies in reverse situation).*
 - o *MS 1 gives clearance on the tax status of a hybrid entity resident in MS 1 which is controlled by residents of MS 2. Such a ruling could be relevant for the tax authorities of MS 2 (same applies in reverse situation).*
 - o *MS 1 gives clearance to a company resident in MS 1 regarding the tax value for depreciation for an asset that is acquired from a group company in MS 2. Such a ruling could be relevant for the tax authorities of MS 2 (same applies in reverse situation).*

- *In order to start a review process with respect to administrative practices, MSs are invited to share with the Group their knowledge or suspicion about harmful administrative practices of other Member States.*
- *The criteria for assessing the harmfulness of an administrative practice are the five criteria for harmfulness as laid down in Paragraph B of the Code of Conduct.*

GUIDANCE ON INBOUND PROFIT TRANSFERS

With respect to *inbound profit transfers*, the Group, noting the guidance on Rollback and Standstill contained in the Code Group's Report to ECOFIN Council on 26-27 November 2000, agreed on 22 November 2010 (doc. 16766/10) the following guidance:

Member States may opt to tax inbound profit transfers or to operate a participation exemption. Member States which operate a participation exemption should either ensure that the profits which give rise to foreign source dividends are subject to effective anti-abuse or countermeasures, or apply switch-over provisions targeted at ensuring effective taxation. The first could be achieved through a Member State having CFC-legislation or other anti-abuse provisions which ensure that profits artificially diverted from that Member State which may give rise to foreign source dividends are appropriately taxed.

GUIDANCE ON PROFIT PARTICIPATING LOANS

Regarding **Profit Participating Loans**, the Group agreed on 25 May 2010 (doc. 10033/10) that a problem arises when the Member State of the corporate taxpayer paying interest allows its deduction from the tax base, whereas the Member State of the corporate taxpayer which receives the income considers it as a tax exempted dividend income. In that case, such income would remain untaxed in both Member States.

To avoid these mismatches, the Group agreed the following solution:

A hybrid loan arrangement is a financial instrument that has characteristics of both debt and equity. In as far as payments under a hybrid loan arrangement are qualified as a tax deductible expense for the debtor in the arrangement, Member States shall not exempt such payments as profit distributions under a participation exemption.

GUIDANCE ON INTERMEDIATE FINANCING OR LICENSING ACTIVITIES

The Group reached a consensus at the meeting of 20 March 2013 (see doc. 11465/13) on the following section⁵ of the draft guidance for regimes concerning interest, royalties, intermediaries and special economic zones:

Regimes concerning intermediate financing or licensing activities

Regimes providing advance certainty to intermediary financing or licensing activities, whether by law or by administrative practice, will in principle be the object of particular scrutiny by the Code of Conduct Group if one or more of the following circumstances apply:

- a. the regime provides for a standard approach including fixed spreads for intermediary type companies rather than relying on a case by case approach taking account of all the facts and circumstances involved with particular regard to the functions performed and risks assumed;
- b. advance certainty provided by a tax administration concerning the profits reported by an intermediary company does not comply with the OECD Transfer Pricing Guidelines throughout the period to which it relates including the use of an inappropriate transfer pricing methodology.
- c. advance certainty provided by a tax administration is granted *de jure* or *de facto* without any terminal date or with automatic renewal. Similarly if a renewal were granted on application it would be potentially harmful if such cases were not periodically reviewed by the tax authority to ensure an individual examination of the underlying facts and to check the conditions are at arm's length.
- d. The regulations covering the conditions for granting advance certainty for intermediary companies are not publicly available;

⁵ The Group also reached consensus on the section relating to special economic zones but this section was transformed into a separate guidance in 2017, see below.

- e. The regulations covering the conditions for granting advance certainty for intermediary companies does not ensure effective exchange of information of the methodology applied and of the arm's length profit agreed with other concerned MS.
- f. The regime is not equally available (whether on a *de jure* or *de facto* basis) to domestic commercial activities or requires no substantial domestic presence.

MODEL INSTRUCTION FOR THE SPONTANEOUS EXCHANGE OF INFORMATION ON ADVANCE INTERPRETATIONS OF LEGAL PROVISIONS IN CROSS-BORDER SITUATIONS ("RULINGS")

With respect to the spontaneous exchange of information on advance interpretations of legal provisions in cross border situations ("rulings") and in the area of transfer pricing, the Group agreed on 6 June 2014 (doc. 10608/14) on the attached *model instruction*, as developed by the Committee on Administrative Cooperation for Taxation (CACT).

1. Introduction

The purpose of this Model Instruction is to provide practical guidance with a view to improving the effectiveness of the arrangements for spontaneous exchanges of information. It is particularly focused on motivating tax officials to initiate spontaneous exchanges of information on cross-border rulings and unilateral advance transfer pricing agreements (APAs).

Information provided spontaneously is potentially very effective as the information selected by the (local) tax officials draws on their own practical experience regarding what will be relevant to the levying of taxes. Spontaneous exchange of information relies heavily on the active participation and co-operation of tax officials. Therefore it is important for all Member States to develop strategies that aim to encourage and promote the use of spontaneous exchange of information by their tax officials in accordance with Council Directive 2011/16/EU. This Model Instruction supports the implementation of such strategies in the Member States' internal guidelines, procedures and awareness programs for spontaneous exchange of information. It highlights the importance and suggests practical steps to facilitate

the exchanges. This Model Instruction also emphasizes the importance of sending feedback on the effectiveness of the information provided.⁶

Although this Model Instruction specifically targets the spontaneous exchange of cross-border rulings and unilateral APAs, it should be stressed that this does not intend to convey that the spontaneous exchange of any other information that may be relevant to another Member State is less important. The general principles set out in this note (legal basis for spontaneous exchange, the use of the standard forms and the common communication network (CCN), time limits and other practicalities) also apply to spontaneous exchange on other issues, e.g. information detected during a tax audit or investigation.

When communicating with countries outside the EU, the bilaterally agreed procedures must be followed by the competent authority.

2. Legal basis Council Directive 2011/16/EU

2.1. Article 9 Scope and conditions of spontaneous exchange of information

- (1) The competent authority of each Member State shall communicate the information referred to in Article 1(1)⁷ to the competent authority of any other Member State concerned, in any of the following circumstances:
- the competent authority of one Member State has grounds for supposing that there may be a loss of tax in the other Member State;
 - a person liable to tax obtains a reduction in, or an exemption from, tax in one Member State which would give rise to a tax liability in the other Member State;
 - business dealings between a person liable to tax in one Member State and a person liable to tax in the other Member State are conducted through one or

⁶ To localize this Model Instruction, the Member States can, if needed, add an additional paragraph to describe their own national procedures (how to contact the competent authority, notification procedure etc.).

⁷ Article 1(1): "This Directive lays down the rules and procedures under which the Member States shall cooperate with each other with a view to exchanging information that is foreseeably relevant to the administration and enforcement of the domestic laws of the Member States concerning the taxes referred to in Article 2".

more countries in such a way that a saving in tax may result in one or the other Member State or in both;

- the competent authority of a Member State has grounds for supposing that a saving of tax may result from artificial transfers of profits within groups of enterprises;
- information forwarded to one Member State by the competent authority of the other Member State has enabled information to be obtained which may be relevant in assessing liability to tax in the latter Member State.

- (2) The competent authorities of each Member State may communicate, by spontaneous exchange, to the competent authorities of the other Member States any information of which they are aware and which may be useful to the competent authorities of the other Member States.

2.2. Article 10(1) Time limits

- (1) The competent authority to which information referred to in Article 9(1) becomes available shall forward that information to the competent authority of any other Member State concerned as quickly as possible, and no later than one month after it becomes available.

3. Background

3.1. The Code of Conduct for Business Taxation and the Code of Conduct Group

The Code of Conduct for Business Taxation addresses harmful tax competition inside the EU. This is an important factor in reducing distortions in the single market and in preventing significant losses of tax revenue. It is a non-binding instrument of a political character containing political commitments. It was agreed by a "Resolution of the Member States meeting within the Council" in December 1997.

The Code of Conduct contains two central features:

- (1) The commitment from Member States to amend their laws and practices as necessary with a view to eliminating any harmful measures as soon as possible (rollback), and

- (2) The commitment from Member States to refrain from introducing any new tax measures which are harmful within the meaning of the Code (standstill).

In March 1998 the Code of Conduct Group was established to assess harmful business tax measures that may fall within the scope of the Code of Conduct for Business Taxation and to monitor their abolishment. It is a special high-level Council Working Group.

3.2. Definition of a cross-border ruling and examples of cross-border rulings to be sent spontaneously

The Code of Conduct spells out, inter alia, five criteria for assessing whether a tax measure is harmful. One of these criteria is lack of transparency. This element has been given particular emphasis by the Code of Conduct Group in its considerations with respect to the advance interpretation or application of tax provisions by a tax administration to a specific fact pattern of a specific taxpayer (tax rulings). While recognising the potentially positive aspects of such administrative practices, the Code of Conduct Group also agreed on the need to improve the exchange of relevant information specifically for cross-border rulings that may affect tax bases of other Member States. Therefore, in June 2010 the Code of Conduct Group established the following general guidance:

If a Member State provides advance interpretation or application of a legal provision for a cross-border situation or transaction of an individual taxpayer (hereafter: cross-border ruling), which is likely to be relevant for the tax authorities of another Member State, the tax authorities of the first Member State will spontaneously exchange the relevant information regarding this cross-border ruling in accordance with Community law provisions with the latter Member State in order to assure coherent overall taxation.

By means of a non-exhaustive list, this would specifically concern the following types of cross-border rulings:

- (1) MS 1 gives clearance on the absence of a PE in MS 1 to a company resident in MS 2. Such a ruling could be relevant for the tax authorities of MS 2 (same applies in the reverse situation);

- (2) MS 1 gives clearance on specific items related to the tax base of a PE in MS 1 to a company resident in MS 2. Such a ruling could be relevant for the tax authorities of MS 2 (same applies in the reverse situation);
- (3) MS 1 gives clearance on the tax status of a hybrid entity resident in MS 1 which is controlled by residents of MS 2. Such a ruling could be relevant for the tax authorities of MS 2 (same applies in the reverse situation);
- (4) MS 1 gives clearance to a company resident in MS 1 regarding the tax value for depreciation for an asset that is acquired from a group company in MS 2. Such a ruling could be relevant for the tax authorities of MS 2 (same applies in the reverse situation).

3.3. Definition of unilateral advance transfer pricing agreements to be sent spontaneously

Advance transfer pricing agreements are a specific type of cross border ruling relating to transfer pricing.

For the purposes of this document a unilateral advance pricing agreement is any agreement between a single Member State (or its political sub-divisions or local authorities) and a taxpayer that determines, in advance of controlled transactions, an appropriate set of criteria (e.g. method, comparables and appropriate adjustments thereto, critical assumptions as to future events) for the determination of the transfer pricing or the transfer price itself for those controlled transactions over a fixed period of time. This includes an agreement between a MS and a taxpayer on how profits of a permanent establishment should be determined over a fixed period of time.

4. National organization and ensuring effective exchange regarding cross-border rulings and unilateral APAs

This Model Instruction covers cross-border rulings involving companies and unilateral APAs. Examples of the cross-border rulings to be exchanged spontaneously can be found in paragraph 3.2 of this Model Instruction. The cross-border rulings and unilateral APAs as well as feedback (please see paragraph 6) shall be sent by using standard electronic forms. National procedures will indicate who is responsible for filling in those forms in the Member States (for example the decision maker preparing the cross-border ruling or the competent authority). For sending the cross-border rulings and unilateral APAs, the general parts A and B, and specifically section C3 "Other spontaneous information", should be used in the electronic form for spontaneous exchange of information (SIF). To assist the use of the electronic forms, the Commission has together with the Member States prepared an eLearning program on the use of the electronic forms. Please find an empty scanned SIF attached to this document.

Information exchanged shall, as far as possible, be provided by electronic means using the common communication network (CCN) between the competent authorities. Timing of the exchanges has to be in line with Article 10 of the Council Directive 2011/16/EU.

Member States shall ensure that cross-border rulings and unilateral APAs that fulfil the criteria detailed in Article 9 (1) of the Council Directive 2011/16/EU are exchanged with other Member States. The process for exchanging should follow Article 4 of Council Directive 2011/16/EU. It will be the responsibility of the receiving authority to ensure information reaches the correct person. In order to ensure that each Member State has sufficient national procedures in place, the following criteria are to be followed:

- (1) Each Member State ensures that their resource availability, procedures and network for spontaneous exchange of information allows fulfilment of the requirements of the Council Directive 2011/16/EU, in particular that:
 - The national network for spontaneous exchange of information in general provides the possibilities for effective exchange regarding cross-border rulings and unilateral APAs;
 - There is a clear communication channel from the decision maker to the competent authority that sends the information to another Member State.

Each Member State ensures that good quality training is organized and national guidance is prepared for the decision makers who prepare cross-border rulings and/or unilateral APAs.

- The decision makers must have knowledge about the requirements set by Article 9 (1) of Council Directive 2011/16/EU and thus be able to identify relevant cross-border rulings and unilateral APAs that are to be exchanged. They will also be informed and have knowledge of any additional clarifications and practical arrangements to spontaneous exchange of information regarding cross-border rulings and unilateral APAs such as this instruction;
 - The decision makers must have sufficient knowledge on the national information exchange procedure to be able to transfer a relevant cross-border ruling and unilateral APA to another Member State through the designated national competent authorities.
- (2) Each Member State will take all reasonable measures to overcome any additional obstacles that might hinder the effective exchange of information on cross-border rulings and unilateral APAs, in particular that:
- This instruction gives a definition of cross border rulings and examples of cross-border rulings to be sent spontaneously in paragraph 3.2 and a definition of unilateral APAs in paragraph 3.3, but those definitions should not be interpreted too narrowly. If there is some doubt as to whether or not the definitions are met the default position of the decision maker should be to exchange if the conditions of spontaneous exchange conditions (under Article 9(1) Council Directive 2011/16/EU) are otherwise met.

5. Content of information to be sent spontaneously

5.1. Cross-border rulings

When sending spontaneous information on cross-border rulings, the sending Member State should take into consideration some obstacles, which may result in limited use of such information such as language barrier and complexity of the cross-border ruling. Therefore information, which will finally be sent, should be as clear and comprehensive as possible.

Firstly it should be remembered that the purpose of this information is to give the receiving Member State sufficient facts to take a decision as to whether or not the case is potentially significant. Therefore, it is strongly recommended that when sending information about cross-border rulings the sending Member State adheres to the set of principles and guidance contained in this Model Instruction.

At this stage it is up to the sending Member State to determine which information, for example the full text of the cross-border ruling in the original language or any other material, would be considered useful. However at a minimum it is important that a short summary, preferably in English or any other language bilaterally agreed, should be provided and should contain the following information(in the free text box in the SIF Part C Section C3):

- (1) Reference number of the cross-border ruling where available;
- (2) Details of the issue for which the taxpayer requires an answer;
- (3) Administration's response and reasoning. In the case when an administration publishes rulings on its website, inserting a direct link to such ruling would facilitate the work of the receiving Member State;
- (4) Information on whether or not the ruling is binding;
- (5) In the case that it is a binding ruling, information should be supplied regarding who is bound by this ruling (administration and/or taxpayer), and whether this ruling is final (accepted by both parties) or if the ruling can be still appealed against by the taxpayer. As an appeal period may vary from Member State to Member State, the sending Member State should decide whether information about the ruling should be exchanged immediately when the ruling is issued or when the ruling is considered to be final. In making this decision it should be borne in mind that time limit restrictions may be an issue for the recipient Member State of the information;

Finally, the sending Member State should consider limitations arising from Article 17(4)⁸ of the Directive.

⁸ Article 17(4): "The provision of information may be refused where it would lead to the disclosure of a commercial, industrial or professional secret or of a commercial process, or of information whose disclosure would be contrary to public policy."

5.2 Unilateral APAs

The exchange of information is intended to work as a two-step process. The first stage would be a spontaneous exchange of important information about the unilateral APA which should enable the receiving Member State to decide whether a request for additional information under stage 2 was appropriate. To this end the initial spontaneous exchange should include the following information:

- (1) The name, address and tax registration number of the taxpayer to which the unilateral APA is granted;
- (2) The name, address and if available the tax registration number of the other participant to the controlled transaction for which the unilateral APA is granted including why it is considered as being a related party;
- (3) The period covered by the unilateral APA;
- (4) Information on all entities directly involved in the controlled transaction for which the unilateral APA is granted;
- (5) A short description of the transaction/business activity covered by the unilateral APA;
- (6) The transfer pricing method used and the price/margin agreed, as well as any other relevant terms of the unilateral APA, and;
- (7) The estimated value of the transactions covered by the unilateral APA.

Finally, the sending Member State should consider limitations arising from Article 17(4)⁹ of the Directive.

⁹ Article 17(4): "The provision of information may be refused where it would lead to the disclosure of a commercial, industrial or professional secret or of a commercial process, or of information whose disclosure would be contrary to public policy."

6. Feedback

If the sending Member State has requested feedback, the decision maker/auditor in the receiving Member State shall provide feedback to its competent authority. The competent authority shall send feedback as soon as possible and no later than three months after the outcome of the use of the requested information is known (article 14(1))¹⁰.

Even if the sending Member State has not requested feedback, it is good practise to always send feedback to the sending Member State. Feedback on information sent will encourage administrative cooperation between Member States.

7. Monitoring

The Member States are responsible for providing statistics in line with the existing guidelines for statistics on spontaneous exchange of information which provide for an efficient and transparent analysis of the number of cross-border rulings and unilateral APAs sent and received per Member State.

The Commission, based on statistical data provided by the Member States, will prepare summary tables on cross-border rulings and unilateral APAs. Tables will be made available to the Member States for the purpose of discussion in the Code of Conduct group.

¹⁰ Article 14(1): "Where a competent authority provides information pursuant to Articles 5 or 9, it may request the competent authority which receives the information to send feedback thereon. If feedback is requested, the competent authority which received the information shall, without prejudice to the rules on tax secrecy and data protection applicable in its Member State, send feedback to the competent authority which provided the information as soon as possible and no later than three months after the outcome of the use of the requested information is known. The Commission shall determine the practical arrangements in accordance with the procedure referred to in Article 26(2)."

GUIDANCE ON HYBRID ENTITY MISMATCHES CONCERNING TWO MEMBER STATES¹¹

1. For the purposes of this Guidance, which applies to the extent that a mismatch situation concerns two Member States
 - 1.1. an entity is treated as *transparent* for tax purposes
 - 1.1.1. where it is not a taxable entity and it is treated wholly or partly as *look-through*, in the sense that income derived, and expenditure incurred, by or through the entity are treated, for tax purposes, as income and expenditure of the holders of equity interests in the entity, in proportion to their respective interests, or
 - 1.1.2. where it is *disregarded* as a separate entity, in the sense of being treated for tax purposes as a part or branch of the entity that owns it;
 - 1.2. a *hybrid entity* is an entity that is treated for tax purposes as being transparent by one Member State and as not being transparent by another Member State;
 - 1.3. a *mismatch situation* for two Member States, in relation to a hybrid entity, is where the mismatched treatments of that entity by the two Member States, as being transparent and as not being transparent, are relevant to the treatment for tax purposes of a transaction involving the entity;
 - 1.4. a *double deduction* arises where a deduction or other tax relief is given in each of two Member States for the same payment, expense or loss made or incurred by a hybrid entity, insofar as that payment, expense or loss is deducted from or relieved against income that is not received by the hybrid entity;

¹¹ Agreed by the Group on 11 December 2014 (doc. 16553/1/14 REV 1)

- 1.5. a *deduction without inclusion* arises in respect of so much of a payment or expense for which a deduction or other tax relief is given by a Member State but for which there is not a corresponding receipt recognized for tax purposes by any Member State or other State.
2. Where as a result of a mismatch situation for two Member States, in relation to a hybrid entity
 - 2.1. a double deduction would otherwise arise, then, for the purpose of preventing that double deduction, the two Member States concerned should treat that entity as not being transparent, or
 - 2.2. a deduction without inclusion would otherwise arise, then, for the purpose of preventing that deduction without inclusion, the two Member States concerned should treat that entity as being transparent,

notwithstanding the treatment of that entity that would otherwise apply.
3. A hybrid entity should be treated as being transparent or not being transparent, in accordance with this guidance and contrary to the treatment that would otherwise apply, only to the extent that is necessary for the purpose of preventing a double deduction or deduction without inclusion that would otherwise arise, and not for any other purpose.
4. To assist the implementation of this guidance by Member States, each Member State should prepare, and update as necessary, for compilation and publication by the Commission, a list of entities, taking into account the work done in this respect by the OECD
 - 4.1. that can be formed or created under its laws, and
 - 4.2. which it treats as transparent for tax purposes.

Explanatory notes on the guidance on Hybrid Entity Mismatches Concerning Two Member States

These notes are arranged in the order of the relevant paragraphs of the text of draft guidance.

- **General comment on format of the draft text**

Paragraph 1 and its six subparagraphs set out the meaning of certain terms for the purposes of the guidance. *Paragraph 2* does the main work of the guidance - specifying an alignment of treatments of hybrid entities where mismatched treatments would otherwise result in a double deduction or deduction without inclusion. *Paragraph 3* ensures that this alignment cannot be used to achieve unintended results: it is solely to prevent the double deduction or deduction without inclusion. *Paragraph 4* would assist the implementation of the guidance by providing for the gathering together of relevant information from Member States in relation to their treatment of entities.

- **Paragraph 1 - introductory line**

1. For the purposes of this Guidance, which applies to the extent that a mismatch situation concerns two Member States

These introductory words serve three purposes:

They signal that the meanings of terms set out in the paragraph are for the purposes of the guidance only and are not intended to have any wider significance.

They limit the application of the guidance, in addressing mismatched treatments, to situations that are relevant to the tax treatment of a transaction in Member States.

- The text refers to *two* Member States to be clear that each of the mismatched treatments of the hybrid entity – as transparent or non-transparent - is by a Member State. If an aggressive tax planning arrangement involved more than one mismatch the guidance would apply to each mismatch separately.
- A triangular situation in which the entity is located in a third State (EU or non-EU) but where the mismatched treatments are by two Member States would also be covered. The purpose of the text is to exclude a situation where one of the mismatched treatments is by a non-EU State.

The introductory words are also intended to address situations where the hybrid entity is partly owned in a Member State and partly owned in a non-EU State¹². In such circumstances the guidance will only apply *to the extent that* the results of the mismatch are relevant to the Member State concerned.

¹² As the guidance is concerned with *intra-EU* mismatches, the other party to the transaction would be located in a Member State.

- **Paragraph 1.1**

1.1 an entity is treated as transparent for tax purposes

1.1.1 where it is not a taxable entity and it is treated wholly or partly as look-through, in the sense that income derived, and expenditure incurred, by or through the entity are treated, for tax purposes, as income and expenditure of the holders of equity interests in the entity, in proportion to their respective interests, or

1.1.2 where it is disregarded as a separate entity, in the sense of being treated for tax purposes as a part or branch of the entity that owns it;

In order to define *hybrid entity* for the purposes of the guidance, the term *transparent* must first be defined. The meaning of an entity being treated as *transparent* is a cornerstone of the draft guidance.

Although such instances may not be very frequent, the draft guidance explicitly addresses entities that are only *partly* transparent. Where the use of a partly transparent entity would otherwise result in a *double deduction* or *deduction without inclusion*, the draft guidance would prevent the achievement of those results.

The draft guidance focuses on the meaning of transparent rather than the meaning of opaque or non-transparent. Once transparent is defined, the meaning of not being transparent follows without the need for a separate definition: an entity will be treated as not being transparent if (a) it is a taxable entity *or* it is treated neither wholly nor partly as look-through *and* (b) it is not disregarded as a separate entity.

The second subparagraph of the meaning of transparent, which refers to an entity being disregarded as a separate entity, has been included for completeness and is principally relevant to an entity classification option¹³ that does not appear to be currently provided by any Member State.

- **Paragraph 1.2**

1.2. a *hybrid entity* is an entity that is treated for tax purposes as being transparent by one Member State and as not being transparent by another Member State;

The definition above of *hybrid entity* substitutes “Member State” for “State” in the Commission Services’ text, as the definition is being used for guidance in respect of *intra-EU* hybrid entity situations.

The reference to *national classification rules* was deleted from the definition, as some Member States may not have specific classification rules, designating an entity as transparent or non-transparent.

¹³ US “check the box” rules allow an election to disregard an entity as separate from its equity holder.

- **Paragraph 1.3**

1.3. a mismatch situation for two Member States, in relation to a hybrid entity, is where the mismatched treatments of that entity by the two Member States, as being transparent and as not being transparent, are relevant to the treatment for tax purposes of a transaction involving the entity;

It was agreed that a mismatch of treatments by two Member States was only of interest where each MS concerned had a direct interest in the tax consequences of a transaction involving the entity (being a transaction relevant to the *double deduction* or *deduction without inclusion* referred to in paragraph 2). The term *mismatch situation* is, therefore, defined for the purposes of the guidance and then incorporated into paragraph 2 as a condition for the guidance to apply.

- **Paragraphs 1.4 and 1.5**

In the draft guidance proposed by the Subgroup, the reference in the Commission Services' text to "harmful effects" has been replaced by references to two specific types of results of mismatch situations, i.e. *double deduction* and *deduction without inclusion*. The proposed hybrid entity guidance would apply to transactions that result in these effects.¹⁴

The terms *double deduction* and *deduction without inclusion* are given specific meanings to enable these results to be identified objectively.

- The Subgroup considered whether the proposed guidance should only apply where the transaction involving the hybrid entity is between related parties (with appropriate anti-abuse provisions for back-to-back arrangements). The Subgroup did not favour this approach, considering *inter alia* that it would add complexity and could reduce the effectiveness of the guidance: it is not reflected in the proposed draft guidance.
- Similarly, the Subgroup did not favour an exception to the proposed guidance for *bona fide* commercial arrangements, as this could introduce an unwelcome subjectivity into the application of the guidance.

- **Paragraph 1.4**

1.4 a double deduction arises where a deduction or other tax relief is given in each of two Member States for the same payment, expense or loss made or incurred by a hybrid entity, insofar as that payment, expense or loss is deducted from or relieved against the income that is not received by the hybrid entity;

This defines *double deduction* for the purposes of the guidance. The meaning set out is intended to be sufficiently wide in scope to cover situations where the relief is not given by direct deduction - for example, where the relief is given by tax credit.

The ending of sentence in paragraph 1.4 serves to ensure that for the purpose of the guidance term *double deduction* does not cover cases when expenses are deducted in computing hybrid entity income that is doubly taxed.

¹⁴ The proposed guidance would not apply to transactions resulting in other, unspecified, effects: *double deduction* and *deduction without inclusion* were the only categories of double non-taxation, resulting specifically from hybrid entity mismatches, which were identified by the Subgroup.

Reference to the “*same* payment, expense or loss” should be given its ordinary meaning - for example, where a deduction is given in one Member State under a group relief regime to a company other than the company that actually incurred the payment or expense, that deduction must be in respect of the same payment or expense for which the deduction is given in the other Member State.

- **Paragraph 1.5**

1.5 a deduction without inclusion arises in respect of so much of a payment or expense for which a deduction or other tax relief is given by a Member State but for which there is not a corresponding receipt recognized for tax purposes by any Member State or other State;

This defines *deduction without inclusion* for the purposes of the guidance. The guidance is concerned with double non-taxation that arises from the *mismatched* treatment of hybrid entities, causing deductible payments in one Member State not to be taken into account, for inclusion as income, by the other or the same Member State. The aim of the guidance, in the context of a *deduction without inclusion*, is to either deny the deduction of the payment in one Member State or to cause the receipt of the payment, which would otherwise disappear or be ignored for tax purposes, to be brought into account by any Member State.

The text makes clear that a part only of a deductible payment may not have been included as a receipt.

- This could happen where a payment through an entity goes to equity holders in different States - *State A* treating the entity as non-transparent, resulting in non-inclusion of its part of the payment, but *State B* treating the entity as transparent, resulting in inclusion of its part of the payment through the entity. This situation will only result in *deduction without inclusion* as respects the part of the payment that has not been included by *State A*.
- This could also happen - a part only of a deductible payment not being included as a receipt - by virtue of the treatment of a hybrid entity as being *partly* transparent by one of the Member States concerned in a mismatch situation.

The text also ensures that a *deduction without inclusion* is not deemed to arise where there is inclusion of the payment concerned in a third EU or non-EU State.

- This will not affect the restriction of the draft Guidance to intra-EU situations only: the deduction without inclusion must result from a “mismatch situation for two Member States” (see *paragraph 2* of the draft Guidance). It would be wrong, nevertheless, to define *deduction without inclusion* as potentially including situations where the payment concerned had, in fact, been included and recognized for tax purposes in a third State - whether EU or non-EU.
- This will also exclude from the meaning of *deduction without inclusion* payments that are brought into account as income for CFC purposes by a third State - whether EU or non-EU.

The description of the non-inclusion of the payment – “*there is not a corresponding receipt recognised for tax purposes*” – is intended to target situations where, due to mismatched treatments of hybrid entities, payments “disappear”, i.e. they are not brought into account as amounts received at all. A deductible payment can be tax-relieved in a cross-border context by reason either of domestic law or of double tax treaty reliefs and exemptions. In such cases, the other Member State is not prevented from taking appropriate measures.

- **Paragraph 2**

2. Where as a result of a mismatch situation for two Member States, in relation to a hybrid entity

2.1. a double deduction would otherwise arise, then, for the purpose of preventing that double deduction, the two Member States concerned should treat that entity as not being transparent, or

2.2. a deduction without inclusion would otherwise arise, then, for the purpose of preventing that deduction without inclusion, the two Member States concerned should treat that entity as being transparent,

notwithstanding the treatment of that entity that would otherwise apply.

Paragraph 2 contains the text that prevents the mismatched treatment of hybrid entities by Member States from resulting in a *double deduction* or *deduction without inclusion*.

To do so, it draws upon the terms set out in *paragraph 1* to identify the elements that must be present for the guidance to apply, i.e.

- a *mismatch situation* involving two Member States,
- in relation to a *hybrid entity*,
- resulting in a *double deduction*, or *deduction without inclusion*.

Where these elements are present, *paragraph 2* prescribes a fixed alignment of the treatments of the hybrid entity, to prevent the mismatch that results in the *double deduction* or *deduction without inclusion*:

- In the case of *double deduction*, the alignment is for both MS to treat the entity as *not being transparent*.
- In the case of *deduction without inclusion*, the alignment is for both MS to treat the entity as being *transparent*.

This approach, of prescribing fixed alignments, has been adopted as a clear and straightforward approach to anti-mismatch coordination:

- It provides the clearest basis for the alignment of treatments to eliminate mismatches resulting in *double deductions* and *deductions without inclusion* - the central purpose of the Guidance.
- It eliminates the need to refer to the treatment in the Member State under the laws of which the entity was *established*.
- It eliminates any need to refer to *third, i.e. non-EU, States*, which could be a source of some confusion in the context of draft Guidance directed exclusively to *intra-EU mismatches*.
- It eliminates an administratively problematic scenario that could arise with other approaches. This theoretically possible, but improbable, scenario would involve the treatment of an entity being aligned *from transparent to non-transparent* to ensure the inclusion of income in a *deduction without inclusion* mismatch. In such circumstances the entity concerned - to which the income is to be attributed - might not be set up in the tax administration systems of the Member State concerned.

- **Paragraph 3**

3. A hybrid entity should be treated as being transparent or not being transparent, in accordance with this guidance and contrary to the treatment that would otherwise apply, only to the extent that is necessary for the purpose of preventing a double deduction or deduction without inclusion that would otherwise arise, and not for any other purpose.

The Subgroup considered the scope for manipulation inherent in an unqualified alignment-based approach to the proposed guidance (e.g. it could create opportunities for loss-trafficking). *Paragraph 3* is intended to prevent any manipulation or abuse of the proposed guidance.

It should also ensure that no more than is necessary is done to prevent hybrid entity mismatches delivering *double deductions* or *deductions without inclusion*.

- **Paragraph 4**

4. To assist the implementation of this guidance by Member States, each Member State should prepare, and update as necessary, for compilation and publication by the Commission, a list of entities, taking into account the work done in this respect by the OECD

4.1. that can be formed or created under its laws, and

4.2. which it treats as transparent for tax purposes.

The purpose of the compilation of lists is to assist Member States in determining whether there are mismatched treatments in specific instances.

Each Member State will only be asked to list those entities, treated as transparent by that Member State, which can be established under its own laws.

Although this listing should not be an onerous requirement of each Member State, the collected listings should provide a comprehensive picture of the intra-EU treatment of entities, thereby enabling the identification, by taxpayers and tax administrations, of potential mismatches.

Examples

Example 1

- hybrid entity is
 - transparent for MS A purposes so interest is deductible in MS A
 - non-transparent in MS B so interest is deductible in MS B
- **double deduction** arises
- if *alignment to non-transparent treatment* of hybrid entity in MS A and MS B then:
 - MS A would treat Hybrid entity as non-transparent— and the interest would only be deductible in MS B

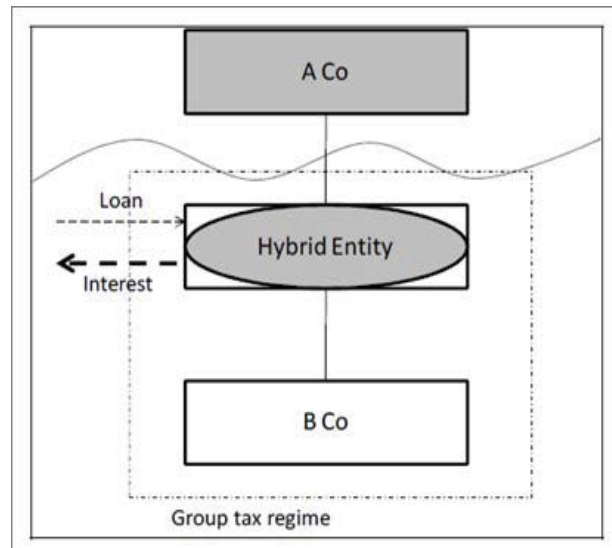

Example 2

- hybrid entity is
 - transparent for MS A purposes so the loan and interest is disregarded
 - non-transparent in MS B so interest is deductible in MS B
- **deduction without inclusion** arises
- if *alignment to transparent treatment* of hybrid entity in MS A and MS B then:
 - the entity, loan and interest would be disregarded and there would be no deduction in MS B

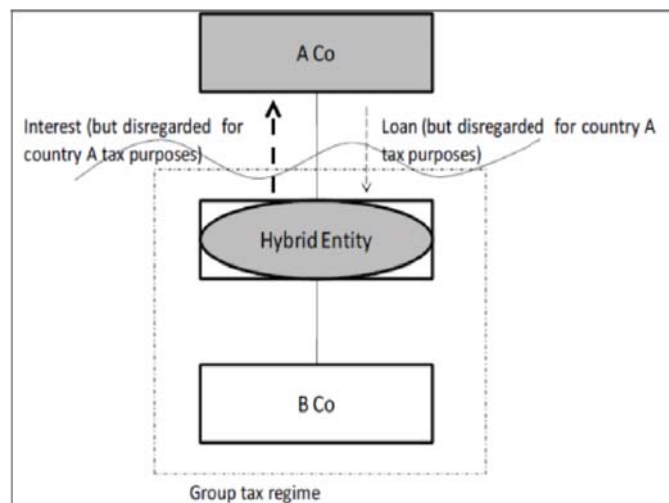

Example 3

- hybrid entity is
 - non-transparent for MS A tax purposes, so the interest arises in a non-resident corporation for MS A purposes
 - transparent in MS B, and no PE in MS B, so interest is deductible in MS B in B Co and is not taxable in MS A
- **deduction without inclusion** arises
- if *alignment to transparent treatment* of hybrid entity in MS A and MS B then:
 - receipt of interest would be recognized in MS A

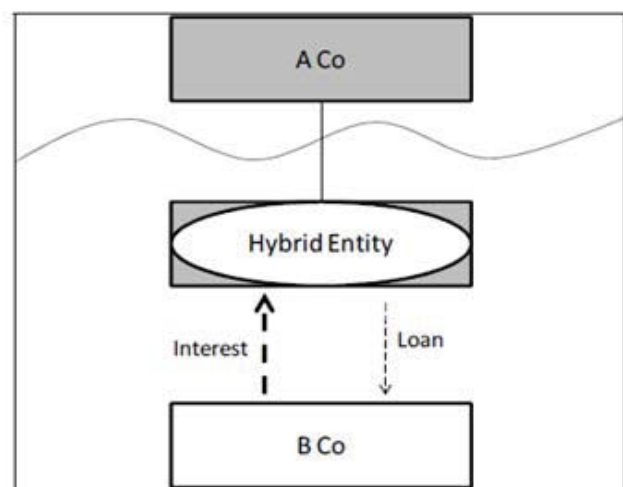

GUIDANCE ON HYBRID PERMANENT ESTABLISHMENT MISMATCHES CONCERNING TWO MEMBER STATES¹⁵

1. For the purposes of this Guidance, which applies to the extent that a mismatch situation concerns two Member States
 - 1.1. a *permanent establishment* is treated as *hybrid* where the business activities of an enterprise:
 - 1.1.1. are not recognised as carried on through a permanent establishment in the Member State where those activities are carried on (the Member State of source) but are recognised as carried on through a permanent establishment in the Member State where the enterprise is a resident (the Member State of residence), or
 - 1.1.2. are recognised as carried on through a permanent establishment in the Member State where those activities are carried on (the Member State of source) but are not recognised as carried on through a permanent establishment in the Member State where the enterprise is a resident (the Member State of residence);
 - 1.2. a *mismatch situation* for two Member States, in relation to a hybrid permanent establishment, is where the mismatched treatment by the two Member States of business activities of an enterprise as carried on through the permanent establishment is relevant to the treatment for tax purposes of profits from business activities of the enterprise;
 - 1.3. *non-taxation without inclusion* arises where the profits from business activities are not taxed in the Member State of source as such activities are treated as not being carried on through a permanent establishment, while those profits are exempt from tax in the Member State of residence as profits attributable to a permanent establishment;

¹⁵ Agreed by the Group on 11 June 2015 (doc. 9620/15)

- 1.4. a *double deduction* arises where a deduction or other tax relief is given in each of two Member States for the same payment, expense or loss attributed to a hybrid permanent establishment, insofar as that payment, expense or loss is deducted from or relieved against income that is not attributed to the hybrid permanent establishment;
2. Where as a result of a mismatch situation for two Member States, in relation to a hybrid permanent establishment:
 - 2.1. a non-taxation without inclusion would otherwise arise, then, for the purpose of preventing the non-taxation without inclusion, the two Member States concerned should treat the business activities concerned as if they were not being carried on through a permanent establishment, or
 - 2.2. a double deduction would otherwise arise, then, for the purpose of preventing the double deduction, the two Member States concerned should treat the business activities concerned as if they were not being carried on through a permanent establishment

notwithstanding the treatment of such activities or amount that would otherwise apply.

3. Paragraph 2 of this Guidance should apply only to the extent that is necessary for the purpose of preventing a non-taxation without inclusion or a double deduction that would otherwise arise, and not for any other purpose. In no case shall the application of this paragraph result in asymmetrical treatment of income and expenses and in double taxation.

Explanatory Notes on the Guidance on Hybrid Permanent Establishment Mismatches Concerning Two Member States

These notes are arranged in the order of the relevant paragraphs of the text of draft guidance.

- ***General comment on format of the draft text***

Paragraph 1 and its four subparagraphs set out the meaning of certain terms for the purposes of the guidance. *Paragraph 2* does the main work of the guidance - specifying an alignment of treatments of hybrid permanent establishment (“HPE”) where mismatched treatments would otherwise result in non-taxation without inclusion or a double deduction. *Paragraph 3* ensures that this alignment cannot be used to achieve unintended results: it is solely to prevent *non-taxation without inclusion and double deduction* and is applied for dealing with mismatch situations, to the extent that they are not tackled otherwise.

- ***Paragraph 1 - introductory line***

- 1. For the purposes of this Guidance, which applies to the extent that a mismatch situation concerns two Member States**

These introductory words serve the following purposes:

They signal that the meanings of terms set out in the *paragraph 1* and *its subparagraphs* are for the purposes of the guidance only and are not intended to have any wider significance.

They also signal that the application of the guidance, in addressing mismatched treatments, is limited to situations only involving two Member States thereby excluding situations in which the State where the business activities of an enterprise are carried on (the State of source) or the State where the enterprise is a resident (the State of residence) is a non-EU State.

If an aggressive tax planning arrangement would involve more than one mismatch situation the guidance would apply to each mismatch situation separately.

- ***Subparagraph 1.1***

- 1.1. a permanent establishment is treated as hybrid where the business activities of an enterprise are:**

The meaning of a permanent establishment (“PE”) being treated as hybrid is the cornerstone of the draft guidance.

The pre-condition for the existence of a HPE is that an enterprise resident in one Member State carries on business activities in another Member State. The Guidance identifies the following two types of HPE.

1.1.1. not recognised as carried on through a permanent establishment in the Member State where those activities are carried on (the Member State of source) but are recognised as carried on through a permanent establishment in the Member State where the enterprise is a resident (the Member State of residence), or

The first type of HPE refers to inconsistent treatment of business activities carried on in a Member State by an enterprise resident in another Member State.

This definition deals with a situation where the business activities are recognised as carried on through the PE only in the Member State where the enterprise is a resident.

1.1.2. are recognised as carried on through a permanent establishment in the Member State where those activities are carried on (the Member State of source) but are not recognised as carried on through a permanent establishment in the Member State where the enterprise is a resident (the Member State of residence), or

The second type of HPE refers to the inconsistent treatment of business activities carried on in a Member State by an enterprise resident in another Member State. This definition deals with a situation where the business activities are recognised as carried on through a PE only in the Member State where those activities are carried on. This can give rise to a double deduction in certain circumstances.

- *Subparagraph 1.2*

1.2. a mismatch situation for two Member States, in relation to a hybrid permanent establishment, is where the mismatched treatment by the two Member States of business activities of an enterprise as carried on through the permanent establishment is relevant to the treatment for tax purposes of profits from business activities of the enterprise

As definitions provided in *subparagraph 1.1.* limit the scope of the guidance to the hybrid nature of the PE, the term “a mismatch situation” serves to determine a condition for *paragraph 2* to apply. The mismatch situation would thus arise where an inconsistent treatment of business activities would lead to the undesirable results defined in *subparagraphs 1.3 and 1.4.*

- ***Subparagraph 1.3***

1.3. *a non-taxation without inclusion* arises where the profits from business activities are not taxed in the Member State of source as such activities are treated as not being carried on through a permanent establishment, while those profits are exempt from tax in the Member State of residence as profits attributable to a permanent establishment

This paragraph defines a specific type of double non-taxation, i.e. *a non-taxation without inclusion* resulting from inconsistent treatment of business activities by two Member States (the one of residence and the one of source - *Example 1*).

This definition suggests that *non-taxation without inclusion* could only arise where a Member State of residence of an enterprise eliminates double taxation of profits from business activities carried on in another Member State by the exemption method.

Employment of the credit method would not exclude any profits from business activities from tax in the Member State of residence and therefore this type of effect would not arise.

- ***Subparagraph 1.4***

1.4. *a double deduction* arises where a deduction or other tax relief is given in each of two Member States for the same payment, expense or loss attributed to a hybrid permanent establishment, insofar as that payment, expense or loss is deducted from or relieved against the income that is not attributed to the hybrid permanent establishment;

This paragraph defines another type of double non-taxation, i.e. *a double deduction* resulting from an inconsistent treatment of business activities by two Member States (the one of residence and the one of source – *Example 2*).

Unlike in the example of double non-taxation set out in subparagraph 1.3, a double deduction can arise if the enterprise's Member State of residence eliminates double taxation with either the credit or exemption methods. This is because the residence state does not recognize the existence of a PE.

• *Paragraph 2*

2. Where as a result of a mismatch situation for two Member States, in relation to a hybrid permanent establishment

2.1. a non-taxation without inclusion would otherwise arise, then, for the purpose of preventing the non-taxation without inclusion, the two Member States concerned should treat the business activities concerned as if they were not being carried on through a permanent establishment, or

2.2. a double deduction would otherwise arise, then, for the purpose of preventing the double deduction, the two Member States concerned should treat the business activities concerned as if they were not being carried on through a permanent establishment

notwithstanding the treatment of such activities or amount that would otherwise apply.

Paragraph 2 contains the text that prevents the mismatched treatment of HPE by Member States from resulting in *non-taxation without inclusion or double deduction*.

To do so, it draws upon the terms set out in *paragraph 1* to identify the elements that must be present for the guidance to apply, i.e.

- a *mismatch situation* involving two Member States,
- in relation to a *HPE*,
- resulting in *non-taxation without inclusion or double deduction*.

Where these elements are present, *paragraph 2* prescribes the following solutions to prevent the mismatch situation that results in *non-taxation without inclusion or double deduction*:

- in the case of *non-taxation without inclusion*, the alignment is for both Member States to treat relevant business activities as if they were not carried on through a PE;
- in the case of a *double deduction*, the alignment is for both Member States to treat the relevant business activities as if they were not carried on through a PE;

These approaches are adopted as pragmatic solutions to address harmful effects of mismatch situations.

In order to underline that the solutions provided for in *paragraph 2* will be used only to address harmful effects of mismatch situations, its text has been expressed in fictional form ("as if"). In addition, this wording reconfirms that the guidance shall not affect the provisions of double taxation conventions between the source and the residence Member State. Where the guidance results in taxation not in line with the provisions of a double taxation convention, the Member States concerned shall endeavour to solve the issue by mutual agreement, if applicable. In this context, it would be useful to consider relevant modifications of double taxation conventions, where appropriate.

- ***Paragraph 3***

3. Paragraph 2 of this Guidance should apply only to the extent that is necessary for the purpose of preventing non-taxation without inclusion or a double deduction that would otherwise arise, and not for any other purpose. In no case shall the application of this paragraph result in asymmetrical treatment of income and expenses and in double taxation.

Paragraph 3 serves the following purposes:

- it is intended to prevent any manipulation or abuse of the proposed guidance. It should also ensure that no more than necessary is done to prevent HPE mismatches delivering *non-taxation without inclusion or double deductions*;
- it clarifies that the guidance is applied only when other means (e.g. national rules) are not sufficient to prevent *non-taxation without inclusion or double deductions*;
- it clarifies that the guidance shall not apply to the extent that it would result in asymmetrical treatment of income and double taxation, if this effect would arise as a result of the application of the credit method for the elimination of double taxation.

Examples

Example 1

hybrid PE is

- recognised as PE for MS A tax purposes;
MS A exempts profits of A Co
attributable to PE in MS B;
- not recognised as PE for MS B tax purposes;
MS B does not tax profits
attributable to PE

non-taxation without inclusion arises

- *paragraph 2.1* of the guidance applies:
MS A and MS B do not recognise PE;
MS A taxes profits from activities in MS B

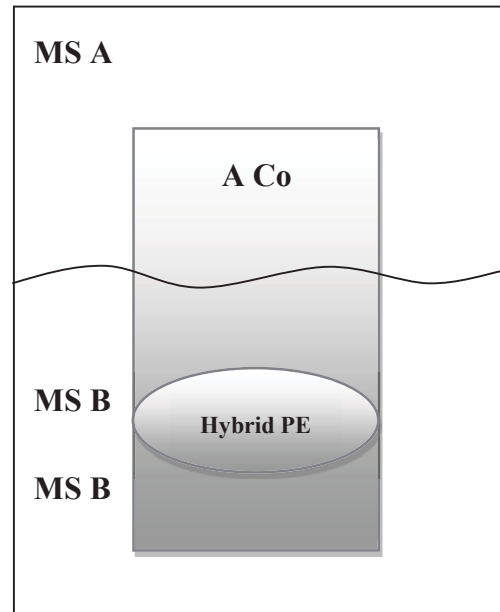

Example 2

hybrid PE is

- not recognised as PE for MS A tax purposes;
It pays interest on a loan;
The interest is set off by A Co against other income;
- recognised as PE for MS B tax purposes;
It has no other income in MS B;
The loss (the interest) is offset against B Co's profits
in MS B.

double deduction arises

- *paragraph 2.2* of the guidance applies:
MS A and MS B do not recognise PE;
MS A taxes; single deduction in MS A.

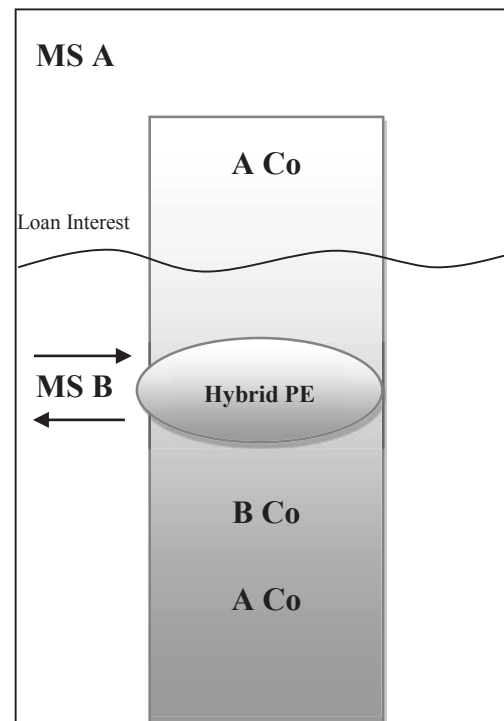

GUIDANCE ON MODIFIED NEXUS APPROACH FOR IP REGIMES¹⁶

A) The Modified Nexus Approach – conceptual issues

1. Nexus Approach: General acceptance of the Modified Nexus Approach as presented in the OECD Report on Action 5, but requiring further modifications relating to the level of qualifying expenditure, grandfathering provisions and the tracking and tracing of expenditure:

2. Up-lift: Under the currently proposed Modified Nexus Approach, businesses using already existing Patent Box regimes might see a reduction in income receiving preferential treatment, as R&D expenditure to develop the patent must be undertaken in a more limited number of entities, including the company holding the relevant patent, to qualify. This could impose restructuring costs on groups which have dedicated R&D companies in order for them to retain the relief in future. Furthermore, to disregard any IP acquisition costs at all might have an impact on commercial decisions. To reflect these concerns raised by businesses, Member States may allow for an up-lift of qualifying expenditure within the Modified Nexus Approach. However, one needs to take into account that the very conceptual basis of the Modified Nexus Approach is intended to ensure that, in order for a significant proportion of IP income to qualify for benefits, a significant proportion of the actual R&D activities must have been undertaken by the qualifying taxpayer itself. Accordingly, such up-lift needs to be restricted. It may only be granted to the extent that expenditure in the context of outsourcing and acquisitions has actually taken place, and it is in any case limited to a certain percentage of the qualifying expenses of the respective company: **30%**. This percentage-based limitation relates to the overall amount of both outsourcing and acquisition costs. For the avoidance of doubt, acquisition costs and expenditures for outsourcing to related parties are not included in qualifying expenditures, but are taken into account in determining the limitation described in the preceding

Example (1):

Parent company incurred qualified expenses of 100,

parent company incurred costs for **acquisition of IP** assets of 10,

subsidiary company incurred R&D expenses of 40.

¹⁶ Endorsed by the Council on 11 December 2014 (doc. 16553/1/14 REV 1)

⇒ Maximum up-lift amount = $100 \times 30 \% = 30$

⇒ Overall qualifying expenses including a limited percentage of outsourcing and acquisition costs = 130

Example (2):

Parent company incurred qualified expenses of 100,

parent company incurred costs for **acquisition of IP** assets of 5,

subsidiary company incurred R&D expenses of 20.

⇒ Maximum up-lift amount = $100 \times 30 \% = 30$

⇒ Overall qualifying expenses including a limited percentage of outsourcing and acquisition costs = 125

B) Timing, grandfathering and reporting issues

1. Close old regime to new entrants: Member States choosing to have IP regimes will need to bring the applicable rules in line with the Modified Nexus Approach. That means that there can be no new entrants to any existing regime after the date that a new regime consistent with the modified nexus approach takes effect, and no later than 30 June 2016. Any legislative process necessary to make this change must commence in 2015. This transition period for the closure of existing regimes to new entrants recognises that Member States will need time for any legislative process.

“New entrants” include both new taxpayers not previously benefiting from the regime and new IP assets owned by taxpayers already benefiting from the regime. Further, it is understood that new entrants are only those that fully meet all substantive requirements of the regime and have been officially approved by the tax administration, if required. New entrants therefore do not include taxpayers that have only applied for the regime.

2. Final abolition of old regime: In order to give protection for taxpayers benefiting from existing regimes, Member States are allowed to introduce grandfathering rules. Under such rules, all taxpayers benefiting from an existing regime may keep such entitlement until a second specific date (“abolition date”). The period between the two dates should not exceed 5 years (so the abolition date would be **30 June 2021**). After that date, no more benefits stemming from the respective old regimes may be given to taxpayers.

3. Further work to be concluded by June 2015.

a) Reporting requirements under Modified Nexus Approach: An approach to the tracking and tracing of R&D expenditure, that is practical for tax authorities and companies to implement, needs to be developed in order to implement the Modified Nexus Approach. Agreement will also be needed on transitional provisions to enable companies to transfer IP from existing regimes into new regimes. The Code of Conduct Group acknowledges that it might be difficult for companies to provide detailed information about qualifying expenditure for past years under the Modified Nexus Approach if – until the time at which new rules are introduced – there is no requirement for them to track such expenditure. Practical methodologies for identifying qualifying expenditure that companies and tax authorities should use recognising the particular issues regarding qualifying expenditure with respect to expenses incurred prior to the introduction of the Modified Nexus Approach will be agreed. Failure to do so will mean that no tax benefit may be granted to those companies under the Modified Nexus Approach. Special rules will be developed for this time period to ease the tracking and tracing of such expenditure.

b) Additional safeguards: The Code of Conduct Group will discuss measures to mitigate the risks that new entrants seek to avail themselves of existing regimes with a view to benefiting from grandfathering. Examples could include enhanced transparency (e.g., requiring spontaneous exchange of information on taxpayers benefiting from a grandfathered regime regardless of whether a ruling is provided), monitoring of new entrants, and possible restrictions, so as to mitigate the risk of new entrants availing themselves of existing regimes with a view to benefiting from grandfathering.

GUIDANCE ON HYBRID ENTITY MISMATCHES CONCERNING A MEMBER STATE AND A THIRD STATE¹⁷

1. For the purposes of this Guidance, which applies to the extent that a mismatch situation concerns a Member State and a third state
 - 1.1. an entity is treated as *transparent* for tax purposes
 - 1.1.3. where it is not a taxable entity and it is treated wholly or partly as *look-through*, in the sense that income derived, and expenditure incurred, by or through the entity are treated, for tax purposes, as income and expenditure of the holders of equity interests in the entity, in proportion to their respective interests, or
 - 1.1.4. where it is *disregarded* as a separate entity, in the sense of being treated for tax purposes as a part or branch of the entity that owns it;
 - 1.2. a *hybrid entity* is an entity that is treated for tax purposes as being transparent by a Member State and as not being transparent by a third state or vice versa;
 - 1.3. a *mismatch situation* for a Member State and a third state, in relation to a hybrid entity, is where the mismatched treatments of that entity by the two states, as being transparent and as not being transparent, are relevant to the treatment for tax purposes of a transaction involving the entity;
 - 1.4. a *double deduction* arises where a deduction or other tax relief is given in each of two states for the same payment, expense or loss made or incurred by a hybrid entity, insofar as that payment, expense or loss is deducted from or relieved against income that is not received by the hybrid entity;
 - 1.5. a *deduction without inclusion* arises in respect of so much of a payment or expense for which a deduction or other tax relief is given by a state but for which there is not a corresponding receipt recognized for tax purposes by any other state.
2. Where as a result of a mismatch situation for a Member State and a third state, in relation to a hybrid entity

¹⁷ Agreed by the Group on 23 November 2015 (doc. 14302/15)

2.1. a double deduction would otherwise arise, then, for the purpose of preventing that double deduction,

2.1.1. where the third state treats the entity as not being transparent, the Member State concerned should treat that entity as not being transparent, and

2.1.2. where the third state treats the entity as being transparent, the Member State should treat the entity as being transparent,

or

2.2. a deduction without inclusion would otherwise arise, then, for the purpose of preventing that deduction without inclusion,

2.2.1. where the third state treats the entity as being transparent the Member State concerned should treat that entity as being transparent, and

2.2.2. where the third state does not treat the entity as being transparent, the Member State should treat the entity as not being transparent,

notwithstanding the treatment of that entity that would otherwise apply.

3. A hybrid entity should be treated as being transparent or not being transparent, in accordance with this guidance and contrary to the treatment that would otherwise apply, only to the extent that is necessary for the purpose of preventing a double deduction or deduction without inclusion that would otherwise arise – taking into account other rules that neutralise the effects of hybrid mismatches – and not for any other purpose.

4. To assist the implementation of this guidance by Member States, each Member State should prepare, and update as necessary, for compilation and publication by the Commission, a list of entities

4.1. that can be formed or created under its laws, and

4.2. which it treats as transparent for tax purposes.

Explanatory notes on draft guidance on Hybrid Entity Mismatches concerning a Member State and a third state

These notes are arranged in the order of the relevant paragraphs of the text of draft guidance.

- **General comment on format of the draft text**

Paragraph 1 and its subparagraphs set out the meaning of certain terms for the purposes of the guidance. *Paragraph 2* does the main work of the guidance - specifying an alignment of treatments of hybrid entities where mismatched treatments would otherwise result in a double deduction or deduction without inclusion and adding a defensive rule for the situation where alignment cannot be ensured. *Paragraph 3* ensures that this alignment or the use of the defensive rule cannot be used to achieve unintended results: it is solely to prevent the double deduction or deduction without inclusion. *Paragraph 4* would assist the implementation of the guidance by providing for the gathering together of relevant information from Member States in relation to their treatment of entities.

- **Paragraph 1 - introductory line**

1. For the purposes of this Guidance, which applies to the extent that a mismatch situation concerns a Member State and a third state —

These introductory words signal that the meanings of terms set out in the paragraph are for the purposes of the guidance only and are not intended to have any wider significance.

They limit the application of the guidance, in addressing mismatched treatments, to situations that are relevant to the tax treatment of a transaction in Member States where the situation involves a third state. Situations concerning Member States only are not covered by this guidance

A triangular situation in which the entity was created in a Member State but where the mismatched treatment is by another Member State and a third state would also be covered.

- **Paragraph 1.1**

1.1 an entity is treated as transparent for tax purposes

1.1.1 where it is not a taxable entity and it is treated wholly or partly as look-through, in the sense that income derived, and expenditure incurred, by or through the entity are treated, for tax purposes, as income and expenditure of the holders of equity interests in the entity, in proportion to their respective interests, or

1.1.2 where it is disregarded as a separate entity, in the sense of being treated for tax purposes as a part or branch of the entity that owns it;

In order to define *hybrid entity* for the purposes of the guidance, the term *transparent* must first be defined. The meaning of an entity being treated as *transparent* is a cornerstone of the draft guidance.

Although such instances may not be very frequent, the draft guidance explicitly addresses entities that are only *partly* transparent. Where the use of a partly transparent entity would otherwise result in a *double deduction* or *deduction without inclusion*, the draft guidance would prevent the achievement of those results.

The draft guidance focuses on the meaning of transparent rather than the meaning of opaque or non-transparent. Once transparent is defined, the meaning of not being transparent follows without the need for a separate definition: an entity will be treated as not being transparent if (a) it is a taxable entity *or* it is treated neither wholly nor partly as look-through *and* (b) it is not disregarded as a separate entity.

The second subparagraph of the meaning of transparent, which refers to an entity being disregarded as a separate entity, has been included for completeness and is principally relevant to an entity classification option¹⁸ that does not appear to be currently provided by any Member State.

- **Paragraph 1.2**

1.2. a *hybrid entity* is an entity that is treated for tax purposes as being transparent by a Member State and as not being transparent by a third state or vice versa;

There is no reference to *national classification rules* in the definition, as some Member States may not have specific classification rules, designating an entity as transparent or non-transparent.

- **Paragraph 1.3**

1.3. a *mismatch situation* for a Member State and a third state, in relation to a hybrid entity, is where the mismatched treatments of that entity by the two states, as being transparent and as not being transparent, are relevant to the treatment for tax purposes of a transaction involving the entity;

A mismatch of treatments by a Member State and a third state is only of interest where each state concerned has a direct interest in the tax consequences of a transaction involving the entity (being a transaction relevant to the *double deduction* or *deduction without inclusion* referred to in paragraph 2). The term *mismatch situation* is, therefore, defined for the purposes of the guidance and then incorporated into paragraph 2 as a condition for the guidance to apply.

- **Paragraphs 1.4 and 1.5**

In the draft guidance reference is made to two specific types of results of mismatch situations, i.e. *double deduction* and *deduction without inclusion*. The proposed guidance would apply to transactions that result in these effects.¹⁹

¹⁸ US “check the box” rules allow an election to disregard an entity as separate from its equity holder.

The terms *double deduction* and *deduction without inclusion* are given specific meanings to enable these results to be identified objectively.

- It has previously in relation to the guidance on hybrid entity mismatches between two Member States been considered whether that guidance should only apply where the transaction involving the hybrid entity is between related parties (with appropriate anti-abuse provisions for back-to-back arrangements). The Subgroup did not favour this approach, considering *inter alia* that it would add complexity and could reduce the effectiveness of the guidance: it is not reflected in the proposed draft guidance. This reasoning is transposed to the guidance at issue.
- Similarly, the Subgroup has in previous exercises not favoured an exception to the proposed guidance for *bona fide* commercial arrangements, as this could introduce an unwelcome subjectivity into the application of the guidance.

- **Paragraph 1.4**

1.4 a double deduction arises where a deduction or other tax relief is given in each of two states for the same payment, expense or loss made or incurred by a hybrid entity, insofar as that payment, expense or loss is deducted from or relieved against the income that is not received by the hybrid entity;

This defines *double deduction* for the purposes of the guidance. The meaning set out is intended to be sufficiently wide in scope to cover situations where the relief is not given by direct deduction - for example, where the relief is given by tax credit.

The ending of sentence in paragraph 1.4 serves to ensure that for the purpose of the guidance term *double deduction* does not cover cases when expenses are deducted in computing hybrid entity income that is doubly taxed.

Reference to the “*same payment, expense or loss*” should be given its ordinary meaning— for example, where a deduction is given in one state under a group relief regime to a company other than the company that actually incurred the payment or expense, that deduction must be in respect of the same payment or expense for which the deduction is given in the other state.

- **Paragraph 1.5**

1.5 a deduction without inclusion arises in respect of so much of a payment or expense for which a deduction or other tax relief is given by a state but for which there is not a corresponding receipt recognized for tax purposes by any other state;

¹⁹ The proposed guidance would not apply to transactions resulting in other, unspecified, effects: *double deduction* and *deduction without inclusion* are the only categories of double non-taxation, resulting specifically from hybrid entity mismatches, which are identified.

This defines *deduction without inclusion* for the purposes of the guidance. The guidance is concerned with double non-taxation that arises from the *mismatched* treatment of hybrid entities, causing deductible payments in one state not to be taken into account, for inclusion as income, by the other or the same state. The aim of the guidance, in the context of a *deduction without inclusion*, is to either deny the deduction of the payment in one state or to cause the receipt of the payment, which would otherwise disappear or be ignored for tax purposes, to be brought into account by any state.

The text makes clear that a part only of a deductible payment may not have been included as a receipt.

- This could happen where a payment through an entity goes to equity holders in different States— *State A* treating the entity as non-transparent, resulting in non-inclusion of its part of the payment, but *State B* treating the entity as transparent, resulting in inclusion of its part of the payment through the entity. This situation will only result in *deduction without inclusion* as respects the part of the payment that has not been included by *State A*.
- This could also happen - a part only of a deductible payment not being included as a receipt - by virtue of the treatment of a hybrid entity as being *partly* transparent by one of the states concerned in a mismatch situation.

The description of the non-inclusion of the payment – “*there is not a corresponding receipt recognised for tax purposes*” – is intended to target situations where, due to mismatched treatments of hybrid entities, payments “disappear”, i.e. they are not brought into account as amounts received at all. A deductible payment can be tax-relieved in a cross-border context by reason either of domestic law or of double tax treaty reliefs and exemptions. Deductible payments which *have* been brought into account in the other state, but which are not taxable in that state because of an intended exemption or relief, will not be deemed to be part of a *deduction without inclusion* result for the purposes of the guidance.

- **Paragraph 2**

- 2. Where as a result of a mismatch situation for a Member State and a third state, in relation to a hybrid entity**

- 2.1. a double deduction would otherwise arise, then, for the purpose of preventing that double deduction**

- 2.1.1. where the third state treats the entity as not being transparent, the Member State concerned should treat that entity as not being transparent, and**

- 2.1.2. where the third state treats the entity as being transparent, the Member State should treat the entity as being transparent,**

or

- 2.2. a deduction without inclusion would otherwise arise, then, for the purpose of preventing that deduction without inclusion,**

- 2.2.1. where the third state treats the entity as being transparent the Member State concerned should treat that entity as being transparent, and**

2.2.2. where the third state does not treat the entity as being transparent, the Member State should treat the entity as not being transparent,

notwithstanding the treatment of that entity that would otherwise apply.

Paragraph 2 contains the text that prevents the mismatched treatment of hybrid entities by Member States and third states from resulting in a *double deduction* or *deduction without inclusion*.

To do so, it draws upon the terms set out in *paragraph 1* to identify the elements that must be present for the guidance to apply, i.e.

- a *mismatch situation* involving a Member State and a third state,
- in relation to a *hybrid entity*,
- resulting in a *double deduction*, or *deduction without inclusion*.

This approach, of prescribing alignments, has been adopted as a clear and straightforward approach to anti-mismatch coordination:

- It provides the clearest basis for the alignment of treatments to eliminate mismatches resulting in *double deductions* and *deductions without inclusion* - the central purpose of the Guidance.
- It eliminates the need to refer to the treatment in the state under the laws of which the entity was *established*.
- It eliminates an administratively problematic scenario that could arise with other approaches. This theoretically possible, but improbable, scenario would involve the treatment of an entity being aligned *from* transparent *to* non-transparent to ensure the inclusion of income in a *deduction without inclusion* mismatch. In such circumstances the entity concerned - to which the income is to be attributed - might not be set up in the tax administration systems of the Member State concerned.²⁰

Where these elements are present, *paragraphs 2.1.1 to 2.2.2* prescribe an alignment of the treatments of the hybrid entity, to prevent the mismatch that results in the *double deduction* or *deduction without inclusion*.

The agreed guidance relating to intra-EU hybrid mismatch arrangements covers three specific examples which are set out in annex C. Each of these examples involves a mismatch between two Member States, A and B. The guidance removes the mismatch with an “alignment” solution by which the Member States agree to treat the hybrid entity as either transparent or non-transparent. Extending this guidance to cover mismatches involving third countries needs to cover two different cases for each example, i.e. the Member State can be either state A or state B.

Paragraphs 2.1.1 and 2.2.1. are based on the existing intra-EU fixed alignment rules. They work also for those third state situations, in which the Member State can re-characterise the hybrid entity and solve the mismatch.

Paragraphs 2.1.2. and 2.2.2. are introduced as a consequence of the fact that this guidance deals with Member States relations to third states where it cannot be ensured that a fixed alignment approach can be used to eliminate the mismatch as a third state will not be bound by a guidance agreed by EU Member States.

²⁰ This might however occur in scenario 2 of Example 3, see annex C.

Paragraph 2.1.1.

This paragraph covers the situation of payments made by a hybrid entity that give rise to double deduction (see example 1). It is possible for the Member State to be either the state where the hybrid entity is not located (state A) or the state where the hybrid is located (state B).

If the Member State is state A then the existing, intra-EU fixed alignment rule also works for third states. This treats the hybrid entity as non-transparent. As a result A Co (the parent company) cannot deduct the interest.

Paragraph 2.1.2.

This paragraph covers the situation of payments made by a hybrid entity that give rise to double deduction (see example 1). It is possible for the Member State to be either the state where the hybrid entity is not located (state A) or the state where the hybrid is located (state B).

If the Member State is state B then it cannot ensure that A Co is denied the deduction. It can only deal with the situation by treating the hybrid entity as transparent. In the context of the Subgroup guidance this could be expressed as an alignment to transparent, which denies a deduction to the hybrid entity paying the interest.

Paragraph 2.2.1.

The paragraph covers the situation of payments made by a hybrid entity that give rise to deduction/non-inclusion (see example 2). It is possible for the Member State to be either the state where the hybrid entity is not located (state A) or the state where the hybrid is located (state B).

If the Member State is state B then the existing, intra-EU fixed alignment to transparent also works for third states. Treating the hybrid entity as transparent means it cannot deduct the interest it pays and as a result there would be no deduction in B Co under the group tax regime in state B.

Paragraph 2.2.2.

The paragraph covers the situation of payments made by a hybrid entity that give rise to deduction/non-inclusion (see example 2). It is possible for the Member State to be either the state where the hybrid entity is not located (state A) or the state where the hybrid is located (state B).

If the Member State is state A then it cannot ensure that the hybrid entity is denied the deduction. It can only deal with the situation by regarding the hybrid entity as non-transparent. In the context of the Subgroup guidance this could be expressed as an alignment to non-transparent, which has the effect of taxing the interest paid to A Co (the parent company).

Paragraphs 2.2.1. and 2.2.2. also cover the situation where payments made to a reverse hybrid give rise to deduction/non-inclusion (see example 3). It is possible for the Member State to be either the state where the hybrid entity is not located (state A) or the state where the hybrid is located (state B).

If the Member State is state A then the existing, intra-EU fixed alignment to transparent (paragraph 2.2.1.) also works for third states. Treating the hybrid entity as transparent means that the income is recognised in state A.

If the Member State is state B then it cannot ensure that the income is recognised in state A. However, an alignment to non-transparent (paragraph 2.2.2.) would ensure that the income was included as ordinary income of the hybrid entity in state B.

- **Paragraph 3**

3. A hybrid entity should be treated as being transparent or not being transparent, in accordance with this guidance and contrary to the treatment that would otherwise apply, only to the extent that is necessary for the purpose of preventing a double deduction or deduction without inclusion that would otherwise arise – taking into account other rules that neutralise the effects of hybrid mismatches – and not for any other purpose.

The Subgroup considered the scope for manipulation inherent in an unqualified alignment-based approach to the proposed guidance (e.g. it could create opportunities for loss-trafficking). *Paragraph 3* is intended to prevent any manipulation or abuse of the proposed guidance.

The requirement of a double deduction or deduction without inclusion caused by a hybrid mismatch implies that the guidance will only be applied if the effects of the hybrid mismatch are not neutralised by other rules. Paragraph 3 should also ensure that no more than is necessary is done to prevent hybrid entity mismatches delivering *double deductions* or *deductions without inclusion*.

- **Paragraph 4**

4. To assist the implementation of this guidance by Member States, each Member State should prepare, and update as necessary, for compilation and publication by the Commission, a list of entities

4.1. that can be formed or created under its laws, and

4.2. which it treats as transparent for tax purposes.

The purpose of the compilation of lists is to assist Member States in determining whether there are mismatched treatments in specific instances.

Each Member State will only be asked to list those entities, treated as transparent by that Member State, which can be established under its own laws.

Although this listing should not be an onerous requirement of each Member State, the collected listings should provide a comprehensive picture of the intra-EU treatment of entities, thereby enabling the identification, by taxpayers and tax administrations, of potential mismatches.

GUIDANCE ON HYBRID PERMANENT ESTABLISHMENT MISMATCHES CONCERNING A MEMBER STATE AND A THIRD STATE

1. For the purposes of this Guidance, which applies to the extent that a mismatch situation concerns a Member State and a third state.
 - 1.1. a permanent establishment is treated as *hybrid* where the business activities of an enterprise:
 - 1.1.1. are not recognised as carried on through a permanent establishment in the state where those activities are carried on (the state of source) but are recognised as carried on through a permanent establishment in the state where the enterprise is a resident (the state of residence), or
 - 1.1.2. are recognised as carried on through a permanent establishment in the state where those activities are carried on (the state of source) but are not recognised as carried on through a permanent establishment in the state where the enterprise is a resident (the state of residence);
 - 1.2. a mismatch situation for a Member State and a third state, in relation to a hybrid permanent establishment, is where the mismatched treatment by the two states of business activities of an enterprise as carried on through the permanent establishment is relevant to the treatment for tax purposes of profits from business activities of the enterprise;
 - 1.3. non-taxation without inclusion arises where the profits from business activities are not taxed in the state of source as such activities are treated as not being carried on through a permanent establishment, while those profits are exempt from tax in the state of residence as profits attributable to a permanent establishment;
 - 1.4. a double deduction arises where a deduction or other tax relief is given in each of two states for the same payment, expense or loss attributed to a hybrid permanent establishment, insofar as that payment, expense or loss is deducted from or relieved against income that is not attributed to the hybrid permanent establishment;

2. Where as a result of a mismatch situation for a Member State and a third state, in relation to a hybrid permanent establishment:

2.1. a non-taxation without inclusion would otherwise arise, then, for the purpose of preventing the non-taxation without inclusion,

2.1.1. where the third state treats the business activities concerned as if they were not being carried on through a permanent establishment the Member State concerned should treat the business activities concerned as if they were not being carried on through a permanent establishment,

2.1.2. where the third state treats the business activities concerned as if they were being carried on through a permanent establishment the Member State concerned should treat the business activities concerned as if they were being carried on through a permanent establishment,

or

2.2. a double deduction would otherwise arise, then, for the purpose of preventing the double deduction,

2.2.1. where the third state treats the business activities concerned as if they were not being carried on through a permanent establishment the Member State concerned should treat the business activities concerned as if they were not being carried on through a permanent establishment,

2.2.2. where the third state treats the business activities concerned as if they were being carried on through a permanent establishment the Member State concerned should treat the business activities concerned as if they were being carried on through a permanent establishment,

2.2.3. where the third state treats the business activities concerned as if they were being carried on through a permanent establishment and a double deduction still occurs where the Member State concerned treats the business activities concerned as if they were being carried on through a permanent establishment that Member State should remove the double deduction by denying deductions to the company carrying on the business activities that give rise to the mismatch,

notwithstanding the treatment of such activities or amount that would otherwise apply.

3. A business activity should be treated as being carried on through a permanent establishment or not, in accordance with this guidance and contrary to the treatment that would otherwise apply, only to the extent that is necessary for the purpose of preventing a double deduction or non-taxation without inclusion that would otherwise arise – taking into account other rules that neutralise the effects of hybrid mismatches – and not for any other purpose.

Explanatory notes on the Guidance on Hybrid Permanent Establishment Mismatches concerning a Member State and a third state

These notes are arranged in the order of the relevant paragraphs of the text of guidance.

- ***General comment on format of the draft text***

Paragraph 1 and its four subparagraphs set out the meaning of certain terms for the purposes of the guidance. *Paragraph 2* does the main work of the guidance - specifying an alignment of treatments of hybrid permanent establishment (“HPE”) where mismatched treatments would otherwise result in non-taxation without inclusion or a double deduction. *Paragraph 3* ensures that this alignment cannot be used to achieve unintended results: it is solely to prevent *non-taxation without inclusion and double deduction* and is applied for dealing with mismatch situations, to the extent that they are not tackled otherwise.

- ***Paragraph 1 - introductory line***

2. For the purposes of this Guidance, which applies to the extent that a mismatch situation concerns a Member State and a third state

These introductory words serve the following purposes:

They signal that the meanings of terms set out in the *paragraph 1* and *its subparagraphs* are for the purposes of the guidance only and are not intended to have any wider significance.

They also signal that the application of the guidance, in addressing mismatched treatments, is limited to situations only involving a Member State and a third state thereby excluding situations in which the state where the business activities of an enterprise are carried on (the State of source) and the state where the enterprise is a resident (the State of residence) are EU Member States.

If an aggressive tax planning arrangement would involve more than one mismatch situation the guidance would apply to each mismatch situation separately.

- ***Subparagraph 1.1***

1.1. a permanent establishment is treated as hybrid where the business activities of an enterprise are:

The meaning of a permanent establishment (“PE”) being treated as hybrid is the cornerstone of the guidance.

The pre-condition for the existence of a HPE is that an enterprise resident in one state carries on business activities in another state. The Guidance identifies the following two types of HPE.

1.1.1. not recognised as carried on through a permanent establishment in the state where those activities are carried on (the state of source) but are recognised as carried on through a permanent establishment in the state where the enterprise is a resident (the state of residence), or

The first type of HPE refers to inconsistent treatment of business activities carried on in a state by an enterprise resident in another state.

This definition deals with a situation where the business activities are recognised as carried on through the PE only in the state where the enterprise is a resident.

1.1.2. are recognised as carried on through a permanent establishment in the state where those activities are carried on (the state of source) but are not recognised as carried on through a permanent establishment in the state where the enterprise is a resident (the state of residence), or

The second type of HPE refers to the inconsistent treatment of business activities carried on in a state by an enterprise resident in another state. This definition deals with a situation where the business activities are recognised as carried on through a PE only in the state where those activities are carried on. This can give rise to a double deduction in certain circumstances.

- ***Subparagraph 1.2***

1.2. a mismatch situation for a Member State and a third state, in relation to a hybrid permanent establishment, is where the mismatched treatment by the two states of business activities of an enterprise as carried on through the permanent establishment is relevant to the treatment for tax purposes of profits from business activities of the enterprise;

As definitions provided in *subparagraph 1.1.* limit the scope of the guidance to the hybrid nature of the PE, the term “a mismatch situation” serves to determine a condition for *paragraph 2* to apply. The mismatch situation would thus arise where an inconsistent treatment of business activities would lead to the undesirable results defined in *subparagraphs 1.3 and 1.4.*

- **Subparagraph 1.3**

- 1.3. ***a non-taxation without inclusion arises where the profits from business activities are not taxed in the state of source as such activities are treated as not being carried on through a permanent establishment, while those profits are exempt from tax in the state of residence as profits attributable to a permanent establishment;***

This paragraph defines a specific type of double non-taxation, i.e. *a non-taxation without inclusion* resulting from inconsistent treatment of business activities by two states (the one of residence and the one of source - *Example 1*).

This definition suggests that *non-taxation without inclusion* could only arise where a state of residence of an enterprise eliminates double taxation of profits from business activities carried on in another state by the exemption method.

Employment of the credit method should not exclude any profits from business activities from tax in the state of residence and therefore this type of effect should not arise.

- **Subparagraph 1.4**

- 1.4. ***a double deduction arises where a deduction or other tax relief is given in each of two states for the same payment, expense or loss attributed to a hybrid permanent establishment, insofar as that payment, expense or loss is deducted from or relieved against the income that is not attributed to the hybrid permanent establishment;***

This paragraph defines another type of double non-taxation, i.e. *a double deduction* resulting from an inconsistent treatment of business activities by two states (the one of residence and the one of source – *Example 2*).

Unlike in the example of double non-taxation set out in subparagraph 1.3, a double deduction can arise if the enterprise's state of residence eliminates double taxation with either the credit or exemption methods. This is because the residence state does not recognize the existence of a PE.

- *Paragraph 2*

2. Where as a result of a mismatch situation for a Member State and a third state, in relation to a hybrid permanent establishment

- 2.1. a non-taxation without inclusion would otherwise arise, then, for the purpose of preventing the non-taxation without inclusion,

- 2.1.1. where the third state treats the business activities concerned as if they were not being carried on through a permanent establishment the Member State concerned should treat the business activities concerned as if they were not being carried on through a permanent establishment,

- 2.1.2. where the third state treats the business activities concerned as if they were being carried on through a permanent establishment the Member State concerned should treat the business activities concerned as if they were being carried on through a permanent establishment,

or

- 2.2. a double deduction would otherwise arise, then, for the purpose of preventing the double deduction,

- 2.2.1. where the third state treats the business activities concerned as if they were not being carried on through a permanent establishment the Member State concerned should treat the business activities concerned as if they were not being carried on through a permanent establishment,

- 2.2.2. where the third state treats the business activities concerned as if they were being carried on through a permanent establishment the Member State concerned should treat the business activities concerned as if they were being carried on through a permanent establishment,

- 2.2.3. where the third state treats the business activities concerned as if they were being carried on through a permanent establishment and a double deduction still occurs where the Member State concerned treats the business activities concerned as if they were being carried on through a permanent establishment that MS should remove the double deduction by denying deductions to the company carrying on the business activities that give rise to the mismatch,

notwithstanding the treatment of such activities or amount that would otherwise apply.

Paragraph 2 contains the text that prevents the mismatched treatment of HPE by Member States and third countries from resulting in *non-taxation without inclusion or double deduction*.

To do so, it draws upon the terms set out in *paragraph 1* to identify the elements that must be present for the guidance to apply, i.e.

- a *mismatch situation* involving a Member State and a third state,

- in relation to a *HPE*,

- resulting in *non-taxation without inclusion or double deduction*.

This approach, of prescribing alignments, has been adopted as a clear and straightforward approach to anti-mismatch coordination:

- o It provides the clearest basis for the alignment of treatments to eliminate mismatches resulting in non-taxation without inclusion and double deductions - the central purpose of the Guidance.
- o It eliminates an administratively problematic scenario that could arise with other approaches.

Where these elements are present, paragraphs 2.1.1 to 2.2.2 prescribe an alignment of the treatments of the hybrid PE, to prevent the mismatch that results in the non-taxation without inclusion or double deduction.

The agreed guidance relating to intra-EU hybrid PE mismatch arrangements covers two specific examples which are set out in annex A to that guidance. Each of these examples involves a mismatch between two Member States, A and B. The guidance removes the mismatch with an “alignment” solution by which the Member States agree to treat the business activities as being carried on through a PE or not.

Extending this guidance to cover mismatches involving third states makes it necessary to include further cases for each example, i.e. the Member State can be either state A or state B and under Example 2 an additional case is added to take into account cases in which despite the alignment the double deduction is not resolved.

Paragraphs 2.1.1 and 2.2.1. are based on the existing intra-EU fixed alignment rules. They work also for those third state situations, in which the Member State can re-characterise the business activities and solve the mismatch.

Paragraphs 2.1.2. and 2.2.2. are introduced as a consequence of the fact that this guidance deals with Member States relations to third states where it cannot be ensured that a single fixed alignment approach can be used to eliminate the mismatch as a third state will not be bound by a guidance agreed by EU Member States.

Paragraph 2.2.3. is introduced as a consequence of the fact that paragraph 2.2.2. will solve the mismatch but may not remove the double deduction if the Member State concerned still takes into account the interest of the PE.

Paragraph 2.1.1.

The paragraph covers the situation of profits made by a hybrid PE that give rise to a non-taxation without inclusion (see example 1). It is possible for the Member State to be either the state where the hybrid PE is not located (state A) or the state where the hybrid PE is located (state B).

If the Member State is state A (see example 1 case 1) then the existing, intra-EU fixed alignment to transparent also works for third states. By not recognising the hybrid permanent establishment State A will have the right to tax the profits arising in State B and State B can continue not to tax the profits attributable to the hybrid PE. As a result the non-taxation without inclusion is solved.

Paragraph 2.1.2.

The paragraph covers the situation of profits made by a hybrid PE that give rise to non-taxation without inclusion (see example 1). It is possible for the Member State to be either the state where the hybrid entity is not located (state A) or the state where the hybrid PE is located (state B).

If the Member State is state B (see example 1 case 2) then it cannot ensure that the profit made by the hybrid PE is taxed unless it recognises it as a PE. In the context of the Subgroup guidance this could be expressed as an alignment to recognition, which has the effect of taxing the profit of the business activities in state B.²¹

Paragraph 2.2.1.

This paragraph covers the situation of payments made by a hybrid PE that give rise to double deduction (see example 2). It is possible for the Member State to be either the state where the hybrid PE is not located (state A) or the state where the hybrid PE is located (state B).

If the Member State is state B (see example 1 case 1) then the existing, intra-EU fixed alignment rule also works for third states. This means treating the business activities concerned as if they were not carried on through a PE. As a result the deduction of the payment cannot be made in state B.

Paragraph 2.2.2.

This paragraph covers the situation of payments made by a hybrid PE that give rise to double deduction (see example 2). It is possible for the Member State to be either the state where the hybrid PE is not located (state A) or the state where the hybrid PE is located (state B).

If the Member State is state A (see example 2 case 2) then it cannot avoid a double deduction unless it recognises the business activities as a PE resulting in a deduction being possible only in state B. In the context of the Subgroup guidance this could be expressed as an alignment to recognition, which has the effect of a deduction being possible only in State B.

²¹ It might be difficult for State B to find out that State A recognises a PE in State B.

Paragraph 2.2.3.

This paragraph covers the situation of payments made by a hybrid PE that give rise to double deduction (see example 2). The Member State is the state where the hybrid PE is not located (state A).

If the Member State is state A (see example 2 case 3) it would align itself to the treatment in state B and recognise the business activity as a PE. This would remove the hybrid mismatch, but it will not necessarily in all cases remove the double deduction. In case the PE makes a profit, relief for the avoidance of double taxation could for instance be granted via the credit method. However, in case the PE incurs a loss, Member State A may take into account this loss as part of its worldwide profits. To remove the double deduction that would then occur, the state would have to deny A Co the deduction. In the context of the Subgroup guidance this could be expressed as an alignment to recognition with an additional rule, which denies a deduction to A Co (the Head office or parent company).

In order to underline that the solutions provided for in paragraph 2 will be used only to address harmful effects of mismatch situations, its text has been expressed in fictional form ("as if"). In addition, this wording reconfirms that the guidance shall not interfere with the provisions of double taxation conventions between the source and the residence state. Where the guidance results in taxation not in line with the provisions of a double taxation convention, Member States concerned shall endeavour to solve the issue by mutual agreement.

- **Paragraph 3**

3. **A business activity should be treated as being a PE or not, in accordance with this guidance and contrary to the treatment that would otherwise apply, only to the extent that is necessary for the purpose of preventing a double deduction or non-taxation without inclusion that would otherwise arise – taking into account other rules that neutralise the effects of hybrid mismatches – and not for any other purpose.**

Paragraph 3 serves the following purposes:

- it is intended to prevent any manipulation or abuse of the proposed guidance. It should also ensure that no more than necessary is done to prevent HPE mismatches delivering *non-taxation without inclusion or double deductions*;
- it clarifies that the guidance is applied only when other means (e.g. national rules) are not sufficient to prevent *non-taxation without inclusion or double deductions*;
- it clarifies that the guidance shall not apply to the extent that it would result in asymmetrical treatment of income and double taxation.

Annex A – Examples

Example 1

hybrid PE is

- recognised as PE for State A tax purposes;
State A exempts profits of A Co
attributable to PE in State B;
- not recognised as PE for State B tax purposes;
State B does not tax profits
attributable to PE

non-taxation without inclusion arises

- Scenario 1 (MS = State A)
If alignment to non-recognition:
State A and State B do not recognise PE;
State A taxes profits from activities in state B
- Scenario 2 (MS = State B)
If alignment to recognition:
State A and State B recognise PE;
State B taxes profits from activities in State B

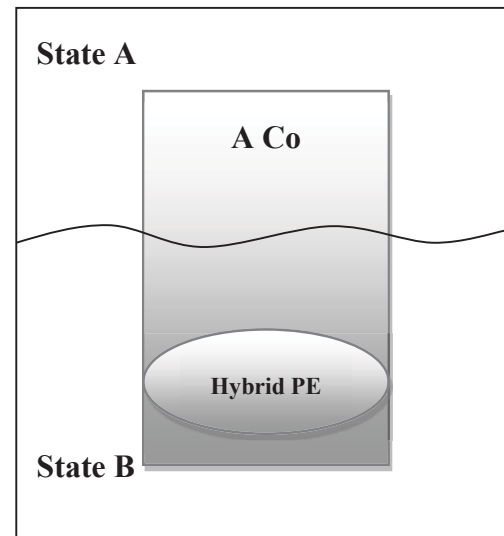

Example 2

hybrid PE is

- not recognised as PE for State A tax purposes;
It pays interest on a loan;
The interest is set off by A Co against other income;
- recognised as PE for State B tax purposes;
The PE as such has no other income in State B;
The loss (the interest) is offset against B Co's profits
in MS B.

double deduction arises

- Scenario 1 (MS = State B)
If alignment to non-recognition:
State A and State B do not recognise PE;
State A taxes; single deduction in State A.
- Scenario 2 (MS = State A)
If alignment to recognition:
State A and State B recognise PE;
State A does not take into account the interest paid; single deduction in State B.
- Scenario 3 (MS = State A and taking into account the loss (interest) of the PE)
If alignment to recognition:
State A and State B recognise PE;
State A denies the Head office (A Co) the deduction.

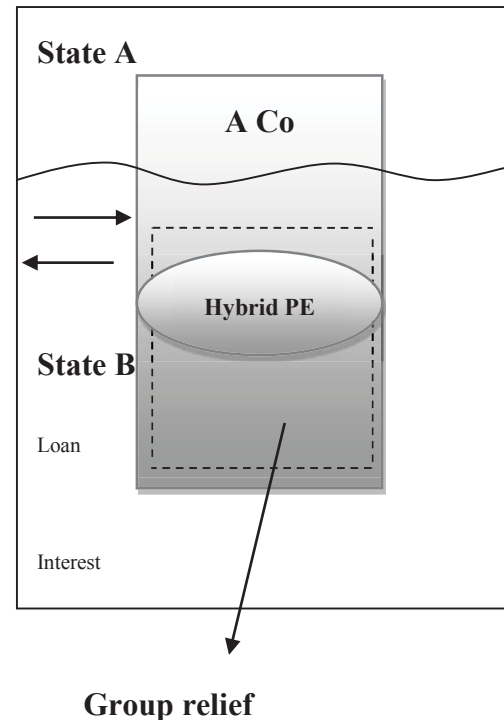

GUIDELINES ON THE CONDITIONS AND RULES FOR THE ISSUANCE OF TAX RULINGS – STANDARD REQUIREMENTS FOR GOOD PRACTICE BY MEMBER STATES²²

The following guidelines apply to the issuing of tax rulings to taxpayers by Member States. For the purposes of these guidelines a ruling is any advice, information or undertaking provided by, or on behalf of, the government or the tax authority of a Member State, or any territorial or administrative subdivisions thereof, to a taxpayer or group of taxpayers concerning their tax situation and on which they are entitled to rely.

However, in order to reduce the administrative burden on Member States, and to ensure consistency with Council Directive 2011/16/EU as amended, these guidelines will not apply to domestic rulings solely for a particular person or a group of persons, excluding those conducting mainly financial or investment activities, with a group-wide annual net turnover, as defined in point (5) of Article 2 of Directive 2013/34/EU of the European Parliament and of the Council²³, of less than EUR 40 000 000 (or the equivalent amount in any other currency) in the fiscal year preceding the date of issuance, amendment or renewal of the rulings.

A. Process of granting a ruling

- a. Official rules and administrative procedures for rulings should be identified in advance and published, and they should include: (i) the conditions for the applicability of the ruling process; (ii) the grounds for denying a ruling; (iii) the fee structure, if applicable; (iv) the legal consequences of obtaining a ruling; (v) possible sanctions for incomplete or false information provided by a taxpayer; (vi) the conditions for revoking, cancelling or revising a ruling; and (vii) any other guidance that is deemed necessary in order to make the rules sufficiently comprehensive and clear to taxpayers and their advisors.

²² Agreed by the Group in November 2016 (doc. 14750/16)

²³ Directive 2013/34/EU of the European Parliament and of the Council of 26 June 2013 on the annual financial statements, consolidated financial statements and related reports of certain types of undertakings, amending Directive 2006/43/EC of the European Parliament and of the Council and repealing Council Directives 78/660/EEC and 83/349/EEC (OJ L 182, 29.6.2013, p. 19).

- b. Tax rulings should be issued, and any administrative discretion in granting a ruling should be exercised, only within the limits of, and in accordance with, the country's relevant domestic tax law and administrative procedures, and should be limited to determining how that law and/or any administrative procedures apply to one or more specific operations or transactions intended, planned or undertaken by the taxpayer.
- c. Tax rulings should respect applicable international obligations that are incorporated into domestic tax law, for instance, obligations under relevant bilateral treaties and EU law.
- d. Tax rulings should be issued in writing.
- e. Tax rulings should only be issued by the competent government office or authority in charge of this task. Where a ruling is granted by another government office, it should be subject to approval by the competent office.
- f. It is recommended that at least two officials are involved in the decision to grant a ruling or there is at least a two-level review process for the decision, in particular in cases where the applicable rules and administrative procedures explicitly refer to discretion or the exercise of judgement by one of the relevant officials.
- g. Tax rulings should be binding on the tax authority (to the extent permitted by domestic law and the principle of legitimate expectation), provided that the applicable legislation and administrative procedures and the factual information on which the ruling is based do not change after the ruling has been granted.
- h. Taxpayers should apply for a ruling in writing and provide a full description of the underlying operations or transactions for which a ruling is requested. The information should be included in a file supporting the ruling application (the "ruling file"). The ruling file should also include information on the methods and facts for determining the key elements of the tax authority's view. Any additional information or relevant facts which are brought to the attention of the tax authority (i.e. in meetings or oral presentations) should be recorded in writing and also be included in the ruling file.

- i. Information concerning the applicant (including taxpayer's name, tax residency, tax identification number, commercial register number for corporations and companies) and tax advisor/tax consultant involved should be included in the ruling file and/or the ruling itself.
- j. Before taking a decision, the person/s providing the ruling should check that the description of the facts and circumstances is sufficient and justifies the envisaged outcome of the ruling. They should also check that the ruling outcome is consistent with any previous rulings concerning similar legal issues and factual circumstances.
- k. In the area of transfer pricing, Member States should also apply the EU guidelines for advance pricing agreements published in the annex to the Commission Communication of 26 January 2007 (COM(2007) 71 final).

B. Term of the ruling and subsequent audit/checking procedure

- a. APAs should only be for a fixed period of time and should be subject to review before being extended.
- b. Taxpayers should notify the tax authority about any material changes in the facts or circumstances on which a taxpayer-specific ruling (including an APA) was based, as soon as possible so that the tax administration can assess whether to exchange this information with another country. As part of this notification process, taxpayers should notify tax administrations of any material changes to the related parties with which they transact (for transactions covered by the ruling) and any other changes which would impact on who information should be exchanged with.
- c. Effective administrative procedures should be in place to periodically verify that the factual information relied upon and assumptions made when granting taxpayer-specific rulings remain relevant throughout the period of validity of the ruling. This may be particularly necessary in the case of APAs where any underlying assumptions and decisions could be affected by changes in economic circumstances.

- d. Rulings should be subject to revision, revocation or cancellation, as the case may be, in the following circumstances:
1. if the taxpayer makes a misrepresentation or omission in applying for the ruling that calls into question the validity of the ruling;
 2. if the relevant laws change;
 3. if there is a relevant and significant change (i) in the facts or circumstances upon which the ruling was based or (ii) in the validity of the assumptions made.

C. Exchange of information

- a. Under EU law relevant rulings will also need to be spontaneously or automatically exchanged with other tax authorities. Rulings may also fall within the scope of other exchange mechanisms such as the OECD framework for compulsory spontaneous exchange of information on rulings, the EU “Model Instruction” or bilateral treaties.

D. Publication

- a. Where a tax ruling has horizontal application to the affairs of other taxpayers in similar situations (also referred to as general rulings by the OECD), it should be published and made easily accessible to other tax administrations and taxpayers. Ideally, such rulings should be published on the tax administration’s website. If not published in full, the website should contain short summaries with links to where the ruling is accessible in full. Publication should take place as soon as it is practicable after the ruling is granted and, at the latest, within six months.
- b. If a Member State does not publish such rulings, for reasons of taxpayer confidentiality, it should however ensure that the conclusions reached in them are published on the tax administration’s website. This can be in the form of either updated guidance, or more general conclusions, and will therefore be available to other taxpayers and tax administrations. This publication can be in an anonymous form without any reference to the taxpayer and thereby respect the principle of taxpayer confidentiality.

PROCEDURAL ISSUES: GUIDANCE ON THE NOTIFICATION OF TAX MEASURES UNDER PARAGRAPH E OF THE CODE²⁴

1. This note provides guidance for Member States regarding the notification of existing and proposed tax measures to the Code of Conduct Group.
2. Standstill notifications should cover any new measures which potentially fall within the scope of the Code and which were enacted in the previous year. Rollback notifications should cover developments regarding measures to which the obligation in paragraph D applies.
3. The guidance deals with:
 - the annual timetable for the notification of tax measures;
 - the identification of measures that should be notified to other Member States;
 - the identification of in which year a measure should be notified, and;
 - the content of notifications.
4. The guidance covers standstill and rollback notifications. Member States should not face any difficulty in identifying measures that should be included in a rollback notification because these will already have been discussed by the Group. However, the question of when a measure has been enacted is relevant for both standstill and rollback.
5. As set out in the Code, where a proposed measure needs parliamentary approval, the information referred to in paragraph E does not have to be given to the Group until after the measure's announcement to Parliament.

Annual Timetable for the notification of tax measures

6. Beginning in October 2016 the Chair will ask Member States to submit their standstill and rollback notifications in time for them to be discussed at the first meeting of the following year. The Chair will set a deadline for the submission of the notifications.
7. The notifications sent to the Chair for discussion in 2017 should cover the 11 month period from 1 February to 31 December 2016. After that notifications should cover the period 1 January to 31 December each year.
8. Member States' standstill and rollback notifications should cover all tax measures which have been enacted in the previous year.

²⁴ Agreed by the Group in November 2016 (doc. 14750/16)

The identification of measures that should be notified to other Member States

9. The fundamental principle is that Member States will notify each other of existing and proposed tax measures which may fall within the scope of the Code. In particular, Member States should provide information on any measure which appears to fall within the scope of the Code.
10. Member States should not interpret their obligation to notify other Member States of relevant tax measures narrowly.
11. When deciding whether to notify a measure Member States must consider the scope of the Code as set out in paragraphs A and B and the breadth of opinion that exists within the Group rather than just their own view of the matter.
12. The annex to this guidance contains a list of different types of measures that have been notified to the Group in the past. As measures of this type have been previously discussed by the Group, Member States should regard the list as indicative of measures that would be notified to it in the future.
13. Amendments to existing measures should be regarded as separate measures and identified by Member States using the principles outlined above.
14. Amendments to existing measures should be notified whether or not the original measure was notified to the Group.

The identification of in which year a measure should be notified

15. In many cases a measure will be proposed and enacted in the same year. Where this is not the case a proposed measure should be notified if it is sufficiently well developed to be discussed in the Group. The presumption is that measures which have been announced in public will be sufficiently well developed to be discussed and therefore should be notified in the January following the announcement (normally the announcement to Parliament, see paragraph E, last sentence of the Code of Conduct).
16. Standstill notifications also cover measures “enacted” in the previous year. To ensure a consistent approach Member States should use the following guidance to identify when a measure should be regarded as “enacted”.

17. A measure will be regarded as “enacted” on the earliest of the following dates;

- the date on which tax advantages become available to taxpayers;

Example: on 7 December 2016 the government announces that a new relief will be introduced. The relief will apply to transactions taking place on or after the date of the announcement. The parliamentary processes are completed on 10 July 2017 and the measure becomes law.

This measure would be regarded as “enacted” on 7 December 2016 because that is the day on which the benefits become available to taxpayers. It should be reported to the Code Group in January 2017.

- the date on which the parliamentary processes necessary to introduce the measure are substantially completed, even if tax advantages have not become available to taxpayers;

Example: on 7 December 2016 the government announces that a new relief will be introduced. The relief will be available from 1 April 2018. The parliamentary processes are completed on 10 July 2017 and the measure becomes law.

This measure would be regarded as “enacted” on 10 July 2017 and should be reported to the Code Group in January 2018.

- the date on which the parliamentary processes necessary to introduce the measure are substantially completed, even if there is no fixed date on which tax advantages will become available to taxpayers or if the availability of the tax advantages depends on further action by the Member State, including the introduction of further legislation;

Example 1: on 7 December 2016 the government announces that a new relief will be introduced but it will not be available until certain macroeconomic conditions are met. The parliamentary processes are completed on 10 July 2017 and the measure becomes law. It is not known when tax benefits will begin to be available to taxpayers.

This measure would be regarded as “enacted” on 10 July 2017 and should be reported to the Code Group in January 2018.

Example 2: on 7 December 2016 the government announces that a new relief will be introduced but not until certain political conditions are met. Draft legislation is published on 11 January 2017 which enables the government to write regulations setting out the nature and scope of the relief. The parliamentary processes are completed on 10 July 2017 and the measure becomes law. No regulations are written and none are planned. It is not known when tax advantages will become available to taxpayers.

This measure would be regarded as “enacted” on 10 July 2017 and should be reported to the Code Group in January 2018, even though the detail of the relief has not been published.

- the date on which tax advantages with a retrospective effect are announced;

Example 1: on 7 November 2016 the government announces that a new relief will be introduced. The tax advantages will be available for accounting periods ending on or after 7 November 2016. This means that the benefits will be available to some companies during 2015, e.g. for a company with a 12 month accounting period ending on 30 November 2016 the benefits would be available from 1 December 2015.

This measure would be regarded as “enacted” on 7 November 2016 and should be reported to the Code Group in January 2017.

Example 2: on 7 November 2016 the government announces that an existing relief will be extended as a result of a decision of the national courts. The amended relief will be backdated to 1 April 2015.

This measure would be regarded as “enacted” on 7 November 2016 and should be reported to the Code Group in January 2017.

18. An administrative practice will be regarded as enacted on the date on which it is adopted by the relevant authority in the Member State (that is the first date on which taxpayers can benefit from the practice), regardless of whether or not any relevant instruction or guidance has been made public.

Content of notifications

19. Standstill notifications should enable the Group to decide whether a measure needs to be considered further. In general, clearer and more detailed notifications will make it easier for the Group to reach a decision efficiently.
20. The relevant authorities in Member States will already have prepared summaries and briefings on new tax measures as part of the national legal and administrative processes. Member States should seek to re-use such documents when notifying the measures to the Group.
21. Rollback notifications will typically deal with the amendment or abolition of a measure. If the measure is being amended, the notification should make it clear how the changes address the harmful aspects previously identified by the Group.

Annex 1

Types of measures previously discussed in the Code of Conduct Group

A. *Investment incentive measures*

1. Development zones
2. New business/start up reliefs
3. R&D tax credits
4. Reinvestment reliefs
5. Rules applying at a regional or local level
6. Special depreciation rules (including capital allowances)
7. Special enterprise zones, free zones, etc.
8. Tax holidays

B. *Measures providing for adjustments to the tax base*

1. Deductions for notional expenses
2. Downward adjustments of profits (such as “excess profits” or capital contributions)²⁵

C. *Measures applying to particular types of activities or profits*

1. Air transport
2. Capital gains
3. Film/television industry
4. Finance branches
5. Headquarters/coordination companies
6. Holding companies
7. Insurance companies

²⁵ As discussed in OECD, *Countering Harmful Tax Practices More Effectively, Taking into Account Transparency and Substance, Action 5 - 2015 Final Report* (October 2015), chapter 5.

8. Intangible assets
9. Interest box
10. Intra-group finance companies
11. Investment funds
12. Manufacturing or distribution activities
13. Offshore activities
14. Patent box
15. Shipping (excluding tonnage tax regimes)

D. Miscellaneous

1. “0/10” type regimes (i.e. nil or very low general rate of CT combined with higher rate for a limited number of activities)
2. Special rules affecting an entity’s territory of residence
3. Personal tax measures similar to those described in the conclusions regarding the scope of the Code, as agreed by the Council High Level Working Party on 31 January 2011²⁶
4. Ruling regimes

²⁶ 6054/11 FISC 14.

PROCEDURAL ISSUES: GUIDANCE ON THE PROVISION OF INFORMATION IN THE REVIEW PROCESS²⁷

1. This note provides guidance for Member States regarding the provision of information under paragraph E of the Code for the purposes of reviewing a tax measure.
2. It deals with;
 - the description of the measure;
 - the importance of factual information about the effect of a measure;
 - situations where insufficient or contradictory factual information is provided to the Group, and;
 - drafting assessments where insufficient information is available.

The description of a measure

3. The description of a measure will be drafted on a bilateral basis by the Commission Services and the Member State concerned. The description should explain the purpose of the measure, the relevant legal framework, the main elements of its design and factual information about its *de facto* effect.
4. If the Commission Services and the Member State cannot reach agreement on the draft description, the Commission Services should circulate a draft which reflects its own understanding of the situation, noting the areas of disagreement.
5. The Member State should provide the Group with information and reasoning which supports its own view. The Group will then agree a final version of the description.

²⁷ Agreed by the Group in November 2016 (doc. 14750/16)

Importance of factual information about the *de facto* effect of a measure

6. The importance of factual information about the effect of a measure was set out in 2008 in the Group's guiding principles concerning the evaluation of measures. These say that assessments will be made on a case-by-case basis and take account of objective economic factors and impact data so that similar cases will not be treated differently. The Group will also consider size and openness of Member States' economies in order to ensure that there is no discrimination between Member States. Equally, it will not use these factors in a way which discriminates against larger or less open Member States. Together with size and openness the Group will consider other relevant factors, such as the transparency of the tax system and the significance of the economic effect on other Member States, in a similarly full and balanced way.²⁸
7. In particular, assessing a measure under criteria 1b and 2b requires a consideration of its *de facto* effect. The agreed description should therefore include factual information concerning the operation of the measure and its effects. Such information may also be relevant to the consideration of the other criteria.

Descriptions of recently introduced measures

8. In the case of a recently introduced measure a Member State may have little or no factual information about its actual effect. In such cases the description should instead include;
 - an analysis of the policy underlying the measure, based on consultation documents, impact assessments or other sources prepared when it was introduced, and;
 - relevant statistical information, including for example, the estimated costs and/or benefits of the measure, the number of taxpayers expected to use it, etc.

*Lack of factual information about the *de facto* effect of a measure*

9. If a Member State has not provided relevant factual information about the effect of the measure the Commission Services shall complete the draft description so far as is possible and circulate it to the Group, noting the lack of factual information and the reason for it.

Information from sources other than the Member State concerned

10. The guiding principles concerning the evaluation of measures make it clear that the Group will consider any economic factor and impact data that are brought to its attention. Therefore factual information on the effect of a measure can be provided by any Member State or the Commission Services.

²⁸ Document 16410/08 FISC 174.

11. In the event that information provided by a Member State or the Commission Services contradicts information provided by the Member State whose measure is being reviewed, the onus will be on the Member State whose measure is being reviewed to resolve the contradiction.
12. If the contradiction cannot be resolved in this way, the Group will need to decide how the information should be interpreted. In reaching a broad consensus on this issue the Group shall exclude the views of the Member State whose measure is being reviewed and of the other Member State (or Member States) which provided information.

Drafting assessments on the basis of insufficient information

13. If a Member State does not provide sufficient relevant factual information about the effect of a measure, the Group can still ask the Commission Services to write a draft assessment of the measure.
14. In some cases, assessments under criteria 1b and 2b have been marked with a question mark to indicate that the Member State did not supply any factual information. The Commission Services should continue to have this option when drafting assessments.
15. When considering an overall assessment of a measure the Group should take account of criteria assessed with a question mark by considering whether the lack of available information suggests that the measure is harmful under criterion 5 due to a lack of transparency.
16. In such cases the Group should also consider, as a separate matter, whether the Member State concerned has fulfilled its standstill and rollback obligations under paragraph C or D of the Code.

GUIDELINES FOR THE PROCESS OF SCREENING OF JURISDICTIONS WITH A VIEW TO ESTABLISHING AN EU LIST OF NON-COOPERATIVE JURISDICTIONS FOR TAX PURPOSES²⁹

1. The screening of the relevant jurisdictions by the Code of Conduct Group (Business Taxation) on the basis of the criteria set out in Part I of this Annex should begin swiftly, with a view to the Council endorsing the EU list of non-cooperative tax jurisdictions before the end of 2017.
2. The Code of Conduct Group (Business Taxation), supported by the General Secretariat of the Council will conduct and oversee the screening process. The Commission services will assist the Code of Conduct Group (Business Taxation) by carrying out the necessary preparatory work for the screening process in accordance with the roles as currently defined under the Code of Conduct for Business Taxation process, with particular reference to previous and ongoing dialogues with third countries.
3. In the screening process, stock should be taken of the work achieved by the Global Forum on Transparency and Exchange of Information for Tax Purposes and the OECD Inclusive Framework for Tackling Base Erosion and Profit Shifting.
4. By January 2017, letters should be sent to jurisdictions selected for screening, inviting these jurisdictions to engage in the process, while ensuring appropriate transparency of this process.
5. By February 2017, the Code of Conduct Group (Business Taxation) should nominate, where relevant, Member States and/or their experts, or groups thereof, to work together with the Commission on the screening of relevant jurisdictions.

²⁹ Endorsed by the Council on 8 November 2016 (doc. 14166/16).

6. By Summer 2017 written contacts and, where necessary, bilateral discussions with jurisdictions concerned should take place, to further engage in the dialogue and explore solutions to concerns with the tax systems of these jurisdictions, as well as to obtain the necessary commitments. The Code of Conduct Group (Business Taxation) should be kept informed and actively involved in this process.
7. By September 2017 the outcome of the bilateral discussions and the state of play thereof should be presented to the Code of Conduct Group (Business Taxation).
8. By the end of 2017, following the necessary preparatory steps at the Code of Conduct Group (Business Taxation), in co-ordination with the High Level Working Party on Tax Questions, the Council should endorse the EU list of non-cooperative jurisdictions.
9. The work on exploring defensive measures at EU level in line with the Council Conclusions of May 2016 should be completed in due time. Any defensive measures should be without prejudice to the respective spheres of competence of the Member States, such as to apply additional measures or maintain lists of non-cooperative jurisdictions at national level of a broader scope.
10. As soon as the listing process is completed, letters should be sent to the listed non-cooperative jurisdictions without delay, with clear explanation for such listing and which steps from a jurisdiction concerned are expected, in order to de-list that jurisdiction.
11. Given that developing countries may lack the capacity to implement the tax transparency standards and anti-BEPS minimum standards according to the same timeline as developed countries, particular account should be taken of this situation during the screening process, provided that such jurisdictions do not rank high in terms of financial activity and do not have financial centers.

12. The Code of Conduct Group (Business Taxation) should further develop the appropriate arrangements on the practical methods and modalities on implementing these guidelines with a view to effective implementation of the screening process of jurisdictions with a view to the establishment by the Council of an EU list of non-cooperative jurisdictions for tax purposes.
13. *Inter alia*, the Code of Conduct Group (Business Taxation) should define, by January 2017, based on objective criteria, the duration of the reasonable timeframe, referred to in criterion 1.3 as well as the scope of application of criterion 2.2. In the context of criterion 2.2, the Code of Conduct Group (Business Taxation) should evaluate the absence of a corporate tax system or applying a nominal corporate tax rate equal to zero or almost zero as a possible indicator.
14. The EU list of non-cooperative jurisdictions should be regularly updated, as necessary, by the Council, along these guidelines, on the basis of information that will be made available to the Commission and/or to the Code of Conduct Group (Business Taxation).

GUIDANCE ON TAX PRIVILEGES RELATED TO SPECIAL ECONOMIC ZONES³⁰

Without prejudice to the second paragraph of letter G of the Code of Conduct, the specific and detailed State Aid rules based on Article 107 TFEU and any other Guidance Notes that may be applicable to specific regimes, business tax privileges available for a special geographic area of a Member State ("special economic zones") will be the object of particular scrutiny by the Code of Conduct Group when one or more of the following circumstances are met:

- a. access to the zone, either *de jure* or *de facto*, specifically favours foreign investors or discriminates against domestic investors or the tax benefits available to companies operating in the zone specifically favour transactions with non-residents or discriminate against domestic transactions;
- b. the regulations for the zone place restrictions on activities that require a substantial economic presence;
- c. the regulations do not require a definite *de jure* and *de facto* link between real economic activity carried on within the zone (such as distribution and manufacturing activities and activities that generate employment, assets and investments) and the profits for which the tax privilege is granted;
- d. tax privileges are available also for the highly mobile activities (for example, activities typical of the banking or insurance industry, intra-group services or activities consisting only of the holding of equity participations and earning only dividends and capital gains) that are permitted in the zone;
- e. there is a lack of regular tax audits verifying that the profits accruing in the zone and allocated to the activities to which tax privileges are available are commensurate with those activities;
- f. the terms and conditions for establishing a zone, for being allowed to operate in the zone and for the benefits available for companies operating in a zone are not clearly defined in public legislation or are not limited in time, or permission to establish a zone or to be active in a zone is subject to discretionary powers.

³⁰ Endorsed by the Council on 16 June 2017 (doc. 10392/17)

GUIDANCE ON THE INTERPRETATION OF THE FOURTH CRITERION OF THE CODE OF CONDUCT FOR BUSINESS TAXATION³¹

1. Purpose of the Guidance

The guidance set out below is based on past decisions of the Code of Conduct Group and is intended to improve the transparency of the Code of Conduct Group's work. It is also intended to help Member States as well as third countries identify more easily potentially harmful tax measures.

The guidance neither replaces the principles and criteria of the Code of Conduct nor prejudices the harmfulness of any particular regime. The guidance presents a non-exhaustive list of elements and characteristics which indicate that a tax measure may be harmful when fully assessed against the criteria in the Code of Conduct. Every assessment will continue to be based on the five criteria of the Code of Conduct on a case-by-case approach.

The purpose of the text is to provide guidance on the application of the criteria in the Code of Conduct but it does not go beyond those criteria nor does it limit them. The guidance can never provide a safe harbour for a particular regime. A tax measure that is the object of particular scrutiny or that requires particular attention under the guidance may be found non-harmful by the Code of Conduct Group; likewise a measure that is not the object of particular scrutiny or that does not require particular attention under the guidance may be found to be harmful when assessed by the Group.

The purpose of the guidance is not to confine the Group to applying pre-determined general criteria; rather it should continue to subject each particular regime to a case-by-case examination against the Code of Conduct criteria in the light of the Group's guiding principles set out in document 16410/08 FISC 174.

³¹ Endorsed by the Council on 5 December 2017 (doc. 15446/17)

2. Relationship with past assessments

Regimes for which the Group has agreed before this guidance enters into force that there was no need to assess them or that have been assessed as not potentially harmful, will not be affected by this guidance. The current procedure for reopening past assessments remains in place.

3. Review of the Guidance

The countering of harmful tax measures is an ongoing process; therefore the present guidance may be periodically reviewed by the Code of Conduct Group to ensure that it reflects future developments.

4. Guidance

Preferential business taxation measures will be the object of particular scrutiny by the Code of Conduct Group (business taxation) when interpreting the fourth criterion if one or more of the following circumstances are met:

1. The measure deviates from the arm's length principle as applied in accordance with the most recent update of the OECD Transfer Pricing Guidelines for profit determination, unless
 - a. this deviation is proportionate and justified with reference to the size of the SMEs as defined in the Commission Recommendation 2003/361/EC, or
 - b. the measure uses "safe harbour" rules for profit determination that are proportionate and justified with reference to the reduction of the administrative burden which the measure is expected to produce.

2. The measure provides for a reduction of the tax base by a specific percentage. However, a reduction in the tax base should not be considered as falling within the scope of the fourth criterion in any specific case where it results that:
 - the tax base before the fixed reduction has been calculated in accordance with the arm's length principle, and
 - the reduction leads to the same result as a reduced tax rate, and
 - the reduction leads to a simplification of tax administration.
3. The measure deviates from the principle that the profits to be attributed to a permanent establishment (PE) are the profits that the PE would have earned at arm's length, in particular in its dealings with other parts of the enterprise, if it were a separate and independent enterprise, regardless of the OECD approach chosen;
4. The measure deviates from the minimum standard committed to under OECD BEPS;
5. The measure allows a deduction for costs or losses that is not symmetrical to the determination of the taxable earnings.

PROCEDURAL ISSUES: GUIDELINES ON SETTING WORKING METHODS FOR AN EFFECTIVE MONITORING OF MEMBER STATES' COMPLIANCE WITH AGREED GUIDANCE

Introduction

1. This note provides guidelines to the Code of Conduct Group ("the Group") regarding the working methods to follow in order to ensure an effective monitoring of Member States' compliance with agreed guidance, guidelines or any other standards agreed by the Group (hereafter referred to as 'agreed guidance').
2. It deals with the:
 - Scope of the monitoring;
 - Procedure for choosing the priority order in which the agreed guidance will be monitored;
 - Monitoring process;
 - Way the results of the monitoring are followed-up [rollback process];
 - Way the results of the monitoring process are publicised [transparency of the outcome of the monitoring].

Scope of the monitoring

3. During its monitoring exercises the Group shall verify Member States' compliance with agreed guidance. The monitoring shall verify in one horizontal exercise the compliance by all Member States.

4. The monitoring shall conclude if national provisions or practices ("national provisions") are "compliant" or "(partly) non-compliant" with the agreed guidance being monitored.
5. As soon as guidance is agreed by the Group, Member States must amend their national provisions to comply with the guidance within a reasonable timeframe, and at the latest within two years from its adoption, unless a different timeline is explicitly indicated by the guidance itself.
6. Monitoring Member States' compliance with agreed guidance shall thus verify whether national provisions *in force at the time of the monitoring* are in line with the agreed guidance being monitored.

Procedure for choosing the priority order in which the agreed guidance will be monitored

7. As a rule the Group shall, when adopting its Work Package (Work Program), decide on a priority list of agreed guidance to be monitored during the relevant period.
8. When setting the aforementioned priority list, the Group shall take account of circumstances such as i) the fact that Member States should be allowed reasonable time and at most two years to amend their laws or practices in order to comply with the relevant guidance, unless a different specific timeframe is provided by the guidance itself; ii) the political sensitivity of the guidance; iii) any other circumstance it considers relevant.
9. The Group may decide to expand the priority list, change the priority order or replace some of the topics initially chosen for monitoring. This may happen if during an ongoing Work Program other topics for example are considered more sensitive, or their immediate monitoring is needed, for example due to developments at the international level.
10. When implementing the priority list, the workload involved should be taken into account and as a principle only one guidance should be monitored at a time.

Monitoring process regarding compliance with agreed guidance

Reporting phase

11. First, the Group shall make an inventory of the relevant national provisions aiming at complying with the agreed guidance being monitored. To this end, the Group shall invite Member States to communicate their relevant national provisions.
12. The reporting shall be done preferably, and to the extent possible, by answering a questionnaire or checklist previously prepared by the Commission services and approved by the Group.
13. If it is not possible to follow the approach of a questionnaire/checklist because of the specificity of the guidance being monitored, a global (wider) reporting approach can be considered.
14. Regardless of the approach followed, the Group may decide whether a different weight is to be attached to the obligations stemming from the agreed guidance, according to their importance³² and/or nature³³. This shall be done upon approval of the questionnaire/checklist, or when the decision to follow a global (wider) reporting approach is made.
15. The Member States shall provide the information in an open and transparent manner and within the agreed deadlines. As regards the quality and accuracy of the information to be provided, Member States are reminded of the note agreed by the Group on *Guidance on the provision of information in the review process*³⁴.
16. Based on the information received, the Commission shall prepare an overview of the national provisions communicated.

³² E.g. principal, secondary or auxiliary obligations

³³ E.g. substantive, procedural, reporting obligations

³⁴ Annex 2 to ANNEX II) doc 14750/16, FISC 202

Reviewing phase

17. The reviewing phase starts with a preliminary assessment by the Commission of the compliance by each Member State with the agreed guidance being monitored.
18. The review process undertaken by the Group shall aim at ensuring a structured and consistent horizontal verification of the national provisions concerned. In order to conclude if national provisions are "compliant", "partly non-compliant" or "non-compliant" with the agreed guidance being monitored, the Group shall endeavour to apply a coherent and equal assessment, in light also of the *General guiding principles concerning evaluation of measures*³⁵.
19. To this purpose and given the specificities of the individual agreed guidance, the assessment approach followed by the Group may differ. Where appropriate, the Group shall take into account the weight attached to the obligations complied with (or not) among all the obligations imposed by the agreed guidance, in order to reach a conclusion regarding the compliance by each Member State with the agreed guidance being monitored.
20. The Group shall do its best to complete this reviewing phase within two to three meetings.

Monitoring the follow-up of the results

21. The Member States whose national provisions are assessed by the Group as "partly non-compliant" or "non-compliant" with the agreed guidance should rollback their laws or practices, in order to comply with the relevant guidance.
22. As a general rule, two years should be sufficient for rollback, unless a different deadline is agreed by the Group in the view of the specificity of the agreed guidance being monitored.
23. The Member States concerned shall inform regularly and at least once during each Presidency period of the state of play of the national provisions adopted or planned for adoption in order to roll back the national provisions assessed as "non-compliant" or "partly non-compliant".

³⁵ General guiding principles concerning evaluation of measures' agreed by the Group in November 2008 (doc. 16410/08 FISC 174).

24. In addition, and depending on the obligations set in the agreed guidance being monitored and failed to comply with, the Group may decide whether the national provisions assessed as "non-compliant" or "partly non-compliant" also constitute a national measure that otherwise is worth assessing separately against the Code criteria to conclude on its harmfulness or lack thereof.
25. The review process in the present Guidelines does not impact in any way the standard review process of tax measures set down in the Council Conclusions of 1 December 1997 establishing the Code of Conduct.
26. Furthermore, it is recalled that the '*General guiding principles concerning evaluation of measures*', agreed by the Group in November 2008 (doc. 16410/08, FISC 174) remains unchanged and will not be affected by the present Guidelines.

Transparency regarding the results of the monitoring process

27. In addition to the general report at the end of each Presidency reflecting the progress made during a specific monitoring exercise, every time a monitoring exercise is finalized, the Group shall report the results to the Council. A monitoring exercise is considered finalized when the Group will have assessed ("compliant", "partly non-compliant" or "non-compliant") all Member States' relevant provisions in respect of a particular agreed guidance.
28. Such final report may comprise:
 - the names of the Member States having complied with the agreed guidance, but also the name of those having failed to comply with the agreed guidance (assessed as "partly non-compliant" or "non-compliant") [if appropriate, accompanied by a summary explanation];
 - the deadline for rollback obligations.

DEFENSIVE MEASURES³⁶

1. Placement of a jurisdiction on the list of non-cooperative jurisdictions for the tax purposes is expected to have a dissuasive effect that encourages jurisdictions to comply with the Criteria, as set out in Annex IV hereto, and as further specified in Annexes V and VI, as well as other relevant international standards.
2. It is important to provide efficient protection mechanisms to fight against the erosion of Member States' tax bases through tax fraud, evasion and avoidance, and consequently, to apply effective and proportionate defensive measures, at the EU and national level, to the jurisdictions in the EU list of non-cooperative jurisdictions for tax purposes.
3. A number of defensive measures in non-tax area at EU level are linked to the EU list of non-cooperative jurisdictions for tax purposes and set out in Part A of this Annex.
4. Moreover, certain defensive measures in tax area could be taken by the Member States, in accordance with their national law, in addition to the non-tax measures taken by the EU, to effectively discourage non-cooperative practices in the jurisdictions placed on the list.
5. A list of such measures in tax area is set out in Part B of this Annex. As these measures should be compatible with the national tax systems of the EU Member States, the implementation of these measures is left to the competence of the Member States.
6. It is to be noted that any defensive measures should be without prejudice to the respective spheres of competence of the Member States to apply additional measures or maintain lists of non-cooperative jurisdictions at national level with a broader scope.

³⁶ Endorsed by the Council on 5 December 2017 (doc. 15429/17)

A. DEFENSIVE MEASURES IN NON-TAX AREA

Article 22 of Regulation (EU) 2017/1601 of the European Parliament and of the Council of 26 September 2017 establishing the European Fund for Sustainable Development (EFSD), the EFSD Guarantee and the EFSD Guarantee Fund contains a link to the EU list of non-cooperative jurisdictions.

Furthermore, should a link with the EU list of non-cooperative jurisdictions for tax purposes be designed in other EU legislative acts in non-tax area in the future, it would be considered as a part of the defensive measures in the context of these Council conclusions.

Overall effects on the compliance by the jurisdictions with the Criteria as a result of such measures should be monitored by the Code of Conduct Group, as well as by the HLWP in the context of implementation of the EU external strategy on taxation.

B. DEFENSIVE MEASURES IN TAX AREA*

B.1. To ensure co-ordinated action, Member States should apply at least one of the following administrative measures in tax area:

- a) Reinforced monitoring of certain transactions;
- b) Increased audit risks for taxpayers benefiting from the regimes at stake;
- c) Increased audit risks for taxpayers using structures or arrangements involving these jurisdictions.

B.2. Without prejudice to the respective spheres of competence of the Member States to apply additional measures, defensive measures of legislative nature in tax area that **could** be applied by the Member States are:

- a) Non-deductibility of costs;
- b) Controlled Foreign Company (CFC) rules;
- c) Withholding tax measures;
- d) Limitation of participation exemption;
- e) Switch-over rule;
- f) Reversal of the burden of proof;
- g) Special documentation requirements;
- h) Mandatory disclosure by tax intermediaries of specific tax schemes with respect to cross-border arrangements;

B.3. Member States could consider using the EU list of non-cooperative jurisdictions for tax purposes as a tool to facilitate the operation of relevant anti-abuse provisions, when implementing Council Directive (EU) 2016/1164 of 12 July 2016 laying down rules against tax avoidance practices that directly affect the functioning of the internal market. For example, where, in accordance with that Directive, Member States, in transposing CFC rules into their national law, use "black" lists of third countries, such lists could cover at least the jurisdictions listed in the EU list of non-cooperative jurisdictions for tax purposes.

GUIDELINES FOR FURTHER PROCESS CONCERNING THE EU LIST OF NON-COOPERATIVE JURISDICTIONS FOR TAX PURPOSES³⁷

1. REVISION OF THE LIST AND DE-LISTING PROCESS

- 1.1. The list of non-cooperative jurisdictions for tax purposes set out in Annex I shall be revised by the Council at least once a year and endorsed on the basis of the report from the Code of Conduct Group on Business Taxation to the Council, indicating the starting date of application of that modification.
- 1.2. This list may be amended or its duration may be modified under the same procedural rules as it has been endorsed. In this process, European Commission should provide the necessary technical assistance.
- 1.3. The decision of the Council will be based on a report of the Code of Conduct Group, in coordination with the HLWP, and prepared by the Committee of Permanent Representatives.
- 1.4. As soon as a jurisdiction is placed on the list, it will be informed by a letter signed by the Chair of the Code of Conduct Group, clearly stating:
 - a) the reasons for its inclusion in the list, and
 - b) which steps from a jurisdiction concerned are expected in order to be de-listed.
- 1.5. As soon as a jurisdiction is removed from the list, it will be swiftly informed of its removal by the letter signed by the Chair of the Code of Conduct Group, with the indication of the starting date of the application of such modification.
- 1.6. Decisions on listing or de-listing a jurisdiction should clearly specify the dates when the defensive measures in tax area should start or cease to apply depending on the nature of the measure, without prejudice to the respective spheres of competence of the Member States, such as adjustment of national legislation on application of defensive measures taken at national level.

³⁷ Endorsed by the Council on 5 December 2017 (doc. 15429/17)

2. COMMITMENTS BY JURISDICTIONS, MONITORING, DIALOGUE AND WAY FORWARD

- 2.1. Commitments officially taken by jurisdictions to implement recommendations requested by the Council in order to address the issues identified should be carefully monitored by the Code of Conduct Group, supported by the General Secretariat of the Council, with technical assistance of the European Commission, in order to evaluate their effective implementation.
- 2.2. Should these jurisdictions fail to address commitments by the established timeframe, the Council will revisit the issue of potential inclusion of the jurisdictions concerned into a list set out in Annex I.
- 2.3. For jurisdictions that present concerns by not fulfilling the requirements of the Criteria, the Code of Conduct Group should continue to seek their high level political commitment, with a concrete timeframe, and effectively address the concerns identified in screening process.
- 2.4. In particular, bilateral discussions should aim at:
 - a) exploring and determining solutions to identified concerns with the tax systems and policies of these jurisdictions, as well as
 - b) obtaining the appropriate and necessary commitments to remedy the situation.
- 2.5. In monitoring commitments, stock should continue to be taken of the work achieved by the Global Forum on Transparency and Exchange of Information for Tax Purposes, the OECD Inclusive Framework for Tackling Base Erosion and Profit Shifting, and of the Forum on Harmful Tax Practices.
- 2.6. The Code of Conduct Group should continue promoting globally the Criteria in coordination with the work of the Global Forum on Transparency and Exchange of Information for tax Purposes, the OECD Inclusive Framework for Tackling Base Erosion and Profit Shifting, and of the Forum on Harmful tax Practices.

- 2.7. Where relevant, if decided by the Code of Conduct Group on the basis of criteria agreed by the Council, monitoring could extend to jurisdictions that were outside the scope of the 2017 screening exercise.
- 2.8. The Code of Conduct Group, supported by the General Secretariat of the Council will continue to conduct and oversee this process, in co-ordination with the HLWP. The Commission services will assist the Code of Conduct Group by carrying out the necessary preparatory work for the screening process in accordance with the roles as currently defined under the Code of Conduct for Business Taxation, with particular reference to previous and ongoing dialogues with third countries.
- 2.9. The Code of Conduct Group should continue developing appropriate practical arrangements on implementing of these Guidelines.
- 2.10. The EU list of non-cooperative jurisdictions shall be updated by the Council, along these Guidelines, on the basis of information that will be made available to the Code of Conduct Group. The Code of Conduct group will work on the basis of information provided to it, inter alia, by the jurisdiction concerned, the Commission or the Member State(s).
- 2.11. Following a balanced review of all collected information, the Code of Conduct Group shall report to the Council at least once a year, on the list of non-cooperative jurisdictions to enable the Council to decide, as appropriate, to include jurisdictions in the list of non-cooperative jurisdictions if they do not comply with the screening criteria, or swiftly remove them from such list, if they fulfil the conditions.
- 2.12. General Secretariat of the Council will continue to serve as a focal point in order to facilitate the process described in this document.

CRITERION 1.3 (THE DURATION OF THE REASONABLE TIMEFRAME)³⁸

1. In line with point 13 of the Guidelines for the process of screening of jurisdictions annexed to the Council Conclusions, the Code of Conduct Group should define, based on objective criteria the duration of the reasonable timeframe, referred to in criterion 1.3.
2. For the purposes of application of criterion 1.3, the duration of the reasonable timeframe, referred to in criterion 1.3, will be construed as follows:
3. With respect to criterion 1.3(i) (sub-point relating to sovereign states), “within a reasonable timeframe” refers to the entry into force of the OECD Multilateral Convention on Mutual Administrative Assistance (MCMAA), as amended, for a given jurisdiction and not to the commitment.
4. With respect to criteria 1.3(i) and 1.3(ii) (sub-points relating to non-sovereign jurisdictions), “within a reasonable timeframe” refers, respectively, to the entry into force of the MCMAA, as amended, for the jurisdiction, and to the entry into force for the jurisdiction of a network of exchange agreements sufficiently broad to cover all Member States.
5. The duration of the reasonable timeframe, for these three points will be identical to the deadline applied in criterion 1.3(ii) in relation to sovereign states: 31 December 2018 (i.e. the same deadline which applies to the entry into force for a sovereign third jurisdiction of a network of exchange arrangements, which is sufficiently broad to cover all Member States).

³⁸ Endorsed by the Council on 5 December 2017 (doc. 15429/17)

6. Without prejudice to the deadline of 31 December 2018, the reasonable timeframe should not extend beyond the time required for:
 - a) the completion of the procedural steps according to national law,
 - b) adoption and entry into force of any required amendments to national law; and
 - c) any other objective deadlines that formal commitment could entail (for example: for a jurisdiction which expresses its consent to be bound by the MCMAA, it enters into force on the first day of the month following the expiration of a period of three months after the date of the deposit of the instrument of ratification, acceptance or approval).
 7. The duration of the reasonable timeframe can only be extended by a consensus of a Code of Conduct Group for a specific non-sovereign jurisdiction, only in duly justified cases.
-

SCOPE OF CRITERION 2.2³⁹

1. For the purposes of application of criterion 2.2, the absence of a corporate tax or applying a nominal corporate tax rate equal to zero or almost zero by a jurisdiction should be regarded as within the scope of Paragraph A of the Code of Conduct for Business Taxation of 1 December 1997 (Code of Conduct).⁴⁰
2. In this respect, where criterion 2.1 is inapplicable solely due to the fact that the jurisdiction concerned does not meet the gateway criterion under Paragraph B of the Code of Conduct ⁴¹, because of the "absence of a corporate tax system or applying a nominal corporate tax rate equal to zero or almost zero"⁴², then the five factors identified in paragraph B of the Code of Conduct should be applied by analogy to assess whether the criterion 2.2⁴³ has been met.
3. In the context of criterion 2.2 the fact of absence of a corporate tax or applying a nominal corporate tax rate equal to zero or almost zero can not alone be a reason for concluding that a jurisdiction does not meet the requirements of criterion 2.2.
4. A jurisdiction should be deemed as non-compliant with criterion 2.2 if it refuses to engage in a meaningful dialogue or does not provide the information or explanations that the Code of Conduct Group may reasonably require or otherwise does not cooperate with the Code of Conduct Group where it needs to ascertain compliance of that jurisdiction with criterion 2.2 in the conduct of the screening process.

³⁹ Endorsed by the Council on 5 December 2017 (doc. 15429/17)

⁴⁰ "Without prejudice to the respective spheres of competence of the Member States and the Community, this code of conduct, which covers business taxation, concerns those measures which affect, or may affect, in a significant way the location of business activity in the Community." (OJ C 2, 06.01.1998, p. 3)

⁴¹ "Within the scope specified in paragraph A, tax measures which provide for a significantly lower effective level of taxation, including zero taxation, than those levels which generally apply in the Member State in question are to be regarded as potentially harmful and therefore covered by this code. Such a level of taxation may operate by virtue of the nominal tax rate, the tax base or any other relevant factor." (OJ C 2, 06.01.1998, p. 3)

⁴² This may operate by virtue of the nominal tax rate, the tax base or any other relevant factor.

⁴³ Criterion 2.2 reads as follows: "*The jurisdiction should not facilitate offshore structures or arrangements aimed at attracting profits which do not reflect real economic activity in the jurisdiction.*"

Terms of reference for the application of the Code test by analogy

A. General framework

1. Criterion from ECOFIN Council Conclusion on 8th November 2016

The jurisdiction should not facilitate offshore structures or arrangements aimed at attracting profits which do not reflect real economic activity in the jurisdiction.

2. Scope of Criterion 2.2 (ECOFIN February 2017)

1. *For the purposes of application of criterion 2.2, the absence of a corporate tax or applying a nominal corporate tax rate equal to zero or almost zero by a jurisdiction should be regarded as within the scope of Paragraph A of the Code of Conduct for Business Taxation of 1 December 1997 (Code of Conduct).⁴⁴*

2. *In this respect, where criterion 2.1 is inapplicable solely due to the fact that the jurisdiction concerned does not meet the gateway criterion under Paragraph B of the Code of Conduct⁴⁵, because of the "absence of a corporate tax system or applying a nominal corporate tax rate equal to zero or almost zero"⁴⁶, then the five factors identified in paragraph B of the Code of Conduct should be applied by analogy to assess whether the criterion 2.2⁴⁷ has been met.*

⁴⁴ *"Without prejudice to the respective spheres of competence of the Member States and the Community, this code of conduct, which covers business taxation, concerns those measures which affect, or may affect, in a significant way the location of business activity in the Community." (OJ C 2, 06.01.1998, p. 3)*

⁴⁵ *"Within the scope specified in paragraph A, tax measures which provide for a significantly lower effective level of taxation, including zero taxation, than those levels which generally apply in the Member State in question are to be regarded as potentially harmful and therefore covered by this code. Such a level of taxation may operate by virtue of the nominal tax rate, the tax base or any other relevant factor." (OJ C 2, 06.01.1998, p. 3)*

⁴⁶ *This may operate by virtue of the nominal tax rate, the tax base or any other relevant factor.*

⁴⁷ *Criterion 2.2 reads as follows: "The jurisdiction should not facilitate offshore structures or arrangements aimed at attracting profits which do not reflect real economic activity in the jurisdiction."*

3. *In the context of criterion 2.2 the fact of absence of a corporate tax or applying a nominal corporate tax rate equal to zero or almost zero cannot alone be a reason for concluding that a jurisdiction does not meet the requirements of criterion 2.2.*

4. *A jurisdiction should be deemed as non-compliant with criterion 2.2 if it refuses to engage in a meaningful dialogue or does not provide the information or explanations that the Code of Conduct Group may reasonably require or otherwise does not cooperate with the Code of Conduct Group where it needs to ascertain compliance of that jurisdiction with criterion 2.2 in the conduct of the screening process.*

3. General remarks

- Scope of Criterion 2.2 as defined by ECOFIN considers the absence of a corporate tax rate or a nominal tax rate equal to zero or almost zero in a jurisdiction as a "measure" significantly affecting the location of business activities (Paragraph A of the Code of Conduct).
- To this extent, Criterion 2.2 is aimed at verifying whether this "measure" facilitates offshore structures or arrangements aimed at attracting profits which do not reflect real economic activity in the jurisdiction.
- Criterion 2.2 applies only when the standard code assessment (i.e. criterion 2.1) cannot be applied because of the absence in a third country jurisdiction of a corporate tax system or because the jurisdiction applies a nominal corporate tax rate equal to zero or almost zero.
- Criterion 2.2 assesses the legal framework and certain economic evidences of a jurisdiction with regard to the five criteria established under paragraph B of the Code of Conduct to be interpreted by analogy.
- Advantages granted by a third country jurisdictions influencing in a significant way the location of business activities have to be seen in connection with a nominal corporate tax rate equal to zero or almost zero as well as in connection with the absence of corporate taxation, to the extent in both cases the standard Code of Conduct test could not be applied. These latter features have in fact to be considered *per se* as advantages to be assessed under this code test.

- In general terms, any guidance developed by the COCG over the years for assessing tax measures within the scope of the 1998 Code of Conduct should be applied consistently and by analogy for the purpose of this test⁴⁸.
- A jurisdiction can only be deemed to have failed the assessment under this criterion when 'offshore structures and arrangements attracting profits which do not reflect real economic activity in the jurisdiction' are due to rules or practices, including outside the taxation area, which a jurisdiction can reasonably be asked to amend, or are due to a lack of those rules and requirements needed to be compliant with this test that a jurisdiction can reasonably be asked to introduce.
- The introduction of a CIT system or a positive CIT rate is not amongst the actions that a third country jurisdiction can be asked to take in order to be in line with the requirements under this test, since the absence of a corporate tax base or a zero or almost zero level tax rate cannot by itself be deemed as criterion for evaluating a jurisdiction as non-compliant.
- Nonetheless, criterion 2.2 implies automatic non-compliance for those jurisdictions that refuse to cooperate with the EU for the assessment of their legal framework.

B. Gateway test

1. Gateway criterion as it reads now in the Code of Conduct

"Within the scope specified in paragraph A, tax measures which provide for a significantly lower effective level of taxation, including zero taxation, than those levels which generally apply in the Member State in question are to be regarded as potentially harmful and therefore covered by this Code."

2. Guidelines for application by analogy

- The functioning of the Gateway test seems rather clear from the definition of scope of Criterion 2.2 as agreed by Ecofin in February this year.

⁴⁸ See doc. 14039/98 of 11 December 1998 "Code of Conduct (Business Taxation) – Interpretation of Criteria" and its further updates.

- In particular, this test is satisfied when "*criterion 2.1 is inapplicable solely due to the fact that the jurisdiction concerned does not meet the gateway criterion under Paragraph B of the Code of Conduct, because of the "absence of a corporate tax system or applying a nominal corporate tax rate equal to zero or almost zero"*

C. Criteria 1 and 2

1. Criterion 1 of the current Code Criteria as it is now

"Whether advantages are accorded only to non-residents or in respect of transactions carried out with non-residents"

2. Criterion 2 of the current Code Criteria as it is now

"Whether advantages are ring-fenced from domestic market, so they do not affect the national tax base"

3. Guidelines for application by analogy

- For the purpose of applying criterion 2.2., "advantages" should be understood as the existence of zero or almost zero taxation or the absence of CIT.
- Factor 1 as well as factor 2 of the current code criteria contain two main elements: (a) legal ring-fencing and (b) de-facto ring-fencing.
- De jure ring-fencing occurs when advantages are only granted to non-residents by the laws and regulations governing the establishment and operations of businesses in a given jurisdiction.
- Where there is no an effective CIT-system in place, it should be then assessed whether aspects of the legal framework, including non-CIT aspects, effectively provide for a ring-fenced scenario.
- An example of that would be non-tax requirements for companies to allow for the residence or for the access to the domestic market of the tested jurisdiction.

- For this purpose, any measure leading to a different treatment between domestic companies and companies held by non-residents or whose activities are disconnected from the domestic market shall be assessed.
- If for instance a jurisdiction grants "advantages" to a company only if it abstains from activities in the local economy (criterion 2) or only to the extent such activities are dependent on a specific business license (criterion 1 and 2) or only to the extent the activities are undertaken by non-residents (criterion 1), this could be assessed as a possible feature of a ring fencing system in place. By analogy this could also be relevant for other taxes (i.e. other than CIT).
- De-facto ring-fencing usually refers to a situation whereby the advantage is not explicitly granted by a country only to non-residents although, in fact, it is enjoyed only or almost only by non-residents.
- As to the de-facto ring-fencing, it is usually considered how many of the taxpayers benefitting from the advantage are in fact non-residents. If, for instance all or nearly all of the subjects benefitting from zero taxation are non-residents (including domestic companies with foreign shareholding), sub-criteria 1 (b) as well as 2 (b) would be considered as met (i.e. the jurisdiction would be deemed to be non-compliant under this step of the Code test).

D. Criterion 3

1. Criterion 3 of the current Code Criteria as it is now

"Whether advantages are granted even without any real economic activity and substantial economic presence with the Member State offering such tax advantages"

2. Guidelines for application by analogy

In order to evaluate whether advantages are granted even without any real economic activity and substantial economic presence, it has to be ascertained:

- whether a jurisdiction does require a company or any other undertaking (e.g. for its incorporation and/or its operations) the carrying out of real economic activities and a substantial economic presence:
 - "Real economic activity" relates to the nature of the activity that benefits from the non-taxation at issue.
 - "Substantial economic presence" relates to the factual manifestations of the activity that benefits from the non-taxation at issue.
 - By way of example and under the assumption that, in general, elements considered in the past by the COCG are relevant also for this analysis, the current assessment should consider the following elements taking into account the features of the industry/sector in question: adequate level of employees, adequate level of annual expenditure to be incurred; physical offices and premises, investments or relevant types of activities to be undertaken.
- whether there is an adequate de jure and de facto link between real economic activity carried on in the jurisdiction and the profits which are not subject to taxation;

- whether governmental authorities, including tax authorities of a jurisdiction, are capable of (and are actually doing) investigations on the carrying out of real economic activities and a substantial economic presence on its territory, and exchanges of relevant information with other tax authorities;
- whether there are any sanctions for failing to meet substantial activities requirements.

E. Criterion 4

1. Criterion 4 of the current Code Criteria as it is now

“Whether the rules for profit determination in respect of activities within a multinational group of companies depart from internationally accepted principles, notably the rules agreed upon within the OECD”

2. Guidelines for application by analogy

- In assessing the adherence of profit determination rules to internationally agreed standards (e.g. OECD TP Guidelines or other similar accounting standards) first of all it should be verified if and to what extent this analysis is relevant for jurisdictions not applying a CIT system.
- To this aim it seems relevant to consider that a jurisdiction not applying a CIT system should not negatively affect a proper allocation of profits departing from internationally agreed standards. Jurisdictions should take appropriate steps in ensuring taxing countries are able to exercise their taxing rights i.e. via CBCR, transparency and other modes of information sharing.
- Where relevant, it should be ascertained if OECD’s agreed principles or similar accounting standards for the determination of profits have been endorsed in a given jurisdiction.

- To this regard, it is critical to ascertain how these rules are implemented and consolidated in the jurisdictions concerned. In the absence of corporate income taxation in a given jurisdiction, also alternative transfer pricing rules can be taken into account, verifying whether they are comparable and compatible with internationally agreed principles (for instance a fair market value approach under international accounting principles).
- This Criterion shall prevent from allowing multinational companies to use transfer pricing rules departing from the OECD Transfer Pricing Guidelines in order to allocate their profits to zero tax jurisdictions.
- Answers to questions from 2.9 to 2. 12 should give sufficient information on how profits are determined highlighting any important departure from internationally agreed standards.

F. Criterion 5

1. Criterion 5 of the current Code Criteria as it is now

"Whether the tax measures lack transparency, including where legal provisions are relaxed at administrative level in a non-transparent way"

2. Guidelines for application by analogy

- Criterion 5 shall evaluate whether certain features of a legal system, including the establishment of a business on its territory, lack sufficient level of transparency.
- More specifically, it has to be assessed whether any elements of the legal system, including the granting of tax residence or the setting up of companies can be granted on a discretionary basis or whether it is bound by the law, verifying whether any legal provision, including non-tax provisions, can be deemed to be discretionary in matters related to the setting up of a company in that jurisdiction.
- This factor shall prevent a jurisdiction from having an insufficient level of transparency within its regulatory framework, considering that advantages as considered in this Code test stem from the registration of a company in a jurisdiction.
- Answers to questions from 2.13 to 2. 16 should give sufficient information on how transparency is ensured in a jurisdiction on certain steps to be undertaken by companies in order to benefit from the advantages provided therein.

PROCEDURAL GUIDELINES FOR CARRYING OUT THE PROCESS OF MONITORING COMMITMENTS CONCERNING THE EU LIST OF NON-COOPERATIVE JURISDICTIONS FOR TAX PURPOSES ⁴⁹

The monitoring process as set out in these guidelines will be carried out based on the Council conclusions of 5 December 2017 (doc. 15429/17), in particular Annex IV.

1. SEQUENCING OF THE MONITORING PROCESS

- 1.1. Jurisdictions are expected to send the Code of Conduct Group (hereafter "COCG") the following information:
 - Phase 1 (*by 9 March 2018*): precise timeline and description of the steps for the implementation of the commitments that they have taken;
 - Phase 2: information in due time about each of the steps mentioned in step 1, including, where relevant, an English translation of their draft legislation(s) as presented to their Parliament so as to enable an early analysis and feedback by the COCG;
 - Phase 3 (*by the agreed deadline*): an English translation of the final measure(s) as enacted.
- 1.2. Technical assistance to the jurisdictions to help them in meeting their specific commitments will be provided by the Commission Services. Where relevant, such technical assistance will also be provided by the OECD Secretariat or Member States.
- 1.3. The COCG ensures the necessary ownership by Member States through delegating the review of preliminary individual assessments prepared by the Commission Services to the subgroup on third countries. When consensus is not achieved in a meeting of the subgroup, the Chair of the subgroup will consult the COCG Chair on the way forward.
- 1.4. If necessary, jurisdictions could also be invited to attend meetings of the COCG or the subgroup, following the procedures of the COCG (i.e. invited jurisdictions can make presentations and answer questions asked by Delegations but they cannot participate in the Group/subgroup discussions and deliberations).
- 1.5. Progress reports on the monitoring process will be submitted to the ECOFIN Council at the end of each semester. An updated version of Annex II of the 5 December 2017 Council conclusions will be included in these progress reports.

⁴⁹ Agreed by the Code of Conduct Group at its meeting of 14 February 2018.

1.6. At the beginning of 2019 (respectively 2020), the COCG will assess the overall implementation of commitments made by jurisdictions with a view to updating the EU list of non-cooperative jurisdictions for tax purposes accordingly.

2. **ACTORS INVOLVED IN THE MONITORING PROCESS**

- 2.1. The day-to-day interactions with jurisdictions on technical aspects of the monitoring process will be carried out by the Commission services, in order to prepare the relevant assessments and decisions by the COCG. The COCG Chair's team and General Secretariat of the Council (hereafter "GSC") will be kept informed of all steps and the Delegations of the Member States will receive weekly or bi-monthly as appropriate a report of all the activities and exchanges undertaken.
- 2.2. The interactions and dialogues on procedural and/or political aspects (e.g. requests by jurisdictions to discuss horizontal or political aspects, further process in the Council) will be conducted by the COCG Chair's team, supported by the GSC, with the technical assistance of the Commission services, liaising with the Presidency and EEAS (e.g. through bilateral meetings or telephone conferences). When the issue is of particular procedural and/or political importance, it will be discussed by the COCG. The Delegations of the Member States will receive by the Chair of the COCG, with the support of GSC, weekly or bi-monthly as appropriate a report of these procedural and political interactions, including all relevant emails, letters and documents.
- 2.3. The GSC will continue to serve as a "focal point" for the monitoring process as set out above. The exchange of formal letters from/to jurisdictions will be channeled through the functional email address (Secretariat.COCG-jurisdictions@consilium.europa.eu). For the sake of transparency and to ensure the necessary ownership of Member States, the same functional email address will be copied in all inbound and outbound correspondence relevant for the monitoring process.
- 2.4. Where urgent decisions by the 28 Member States are required, Fiscal Attachés meetings will be convened, whilst approval by silence procedure should be used only in exceptional circumstances.
- 2.5. All documents requiring a decision should be circulated to delegations at least 3 working days before the meeting concerned (fiscal attachés, subgroup, or COCG), and include as much contextual elements as possible (summary of interactions with the jurisdiction in question).

- 2.6. Where the issue at stake is of technical nature, meeting documents will normally be issued by the Commission services to the subgroup on third countries. Where it is of procedural/political nature, they will normally be issued by the Chair (for the COCG) or the Presidency in connection with the COCG Chair (for the subgroup on third countries).
- 2.7. The COCG Chair, supported by the GSC, will continue liaising with the Chairs of the OECD Committee on Fiscal Affairs, Inclusive Framework on BEPS, Global Forum (GF), and Forum on Harmful Tax Practices (FHTP), with the technical assistance of the Commission Services, in order to ensure that the monitoring process is well coordinated with the activities of the GF and FHTP in terms of scope and timing consistency.

GUIDANCE ON THE INTERPRETATION OF THE THIRD CRITERION OF THE CODE OF CONDUCT FOR BUSINESS TAXATION⁵⁰

8. Purpose of the Guidance

The guidance set out below is based on past decisions of the Code of Conduct Group and is intended to improve the transparency of the Code of Conduct Group's work. It is also intended to help Member States as well as third countries identify more easily potentially harmful tax measures.

The guidance neither replaces the principles and criteria of the Code of Conduct nor prejudices the harmfulness of any particular regime. The guidance presents a non-exhaustive list of elements and characteristics which indicate that a tax measure may be harmful when fully assessed against the criteria in the Code of Conduct. Every assessment will continue to be based on the five criteria of the Code of Conduct on a case-by-case approach.

The purpose of the text is to provide guidance on the application of the criteria in the Code of Conduct but it does not go beyond those criteria nor does it limit them. The guidance can never provide a safe harbour for a particular regime. A tax measure that is the object of particular scrutiny or that requires particular attention under the guidance may be found non-harmful by the Code of Conduct Group; likewise a measure that is not the object of particular scrutiny or that does not require particular attention under the guidance may be found to be harmful when assessed by the Group.

The purpose of the guidance is not to confine the Group to applying pre-determined general criteria; rather it should continue to subject each particular regime to a case-by-case examination against the Code of Conduct criteria in the light of the Group's guiding principles set out in document [16410/08 FISC 174](#).

⁵⁰ Endorsed by the Council on 22 June 2018 (doc. [10373/18](#)).

9. Relationship with past assessments

Past assessments, and regimes for which the Group has agreed in the past that there was no need to assess, will not be affected by the guidance. Regimes that have not been considered by the Group can be reviewed on the basis of this guidance. The current procedure for reopening past assessments remains in place.

10. Review of the Guidance

The countering of harmful tax measures is an ongoing process; therefore the guidance notes could be periodically reviewed by the Code Group to ensure that they reflect future developments.

11. Guidance

1. *Real economic activity*

When

- a regime grants tax benefits to activities such as manufacturing or production,
- the qualifying activities necessary to benefit from the regime do not include any highly mobile activities, or
- the benefits of the regime are directly linked to investment in tangible assets⁵¹,

the regime does a priori not raise concerns under criterion 3 of the Code of Conduct. It would not need to be assessed regarding a substantial economic presence. It would however still need to be subject to an analysis under the nexus requirement.

⁵¹ The investments qualifying for the incentive are long-term investments in the fixed assets (buildings, constructions, technical equipment and facilities) that are used for the performance of economic activities of the company.

When

- a regime does not specify a requirement that activities need to be considered as real economic activities in order to qualify for tax benefits,
- there is an express obligation in a regime that business should be conducted outside the state or territory or there is a de jure or de facto obstacle to conduct such business inside,
- a regime can be considered to be designed to attract highly mobile capital, or
- a regime allows an activity that may under certain circumstances be considered not to constitute a real economic activity

the regime may a priori not be regarded as requiring real economic activity and needs to be further analysed concerning the requirements of the regime for substantial economic presence which should be relevant to the regime type.

In particular, certain types of activities are likely to need such further analysis. These activities could for instance be the following:

- Certain financial services, including intra-group financial services⁵²;
- Intra-group captive insurance⁵³;

⁵² The income generating activity could cover agreeing on funding terms, monitoring and revising agreements and managing risks.

⁵³ The income generating activity could cover predicting and calculating risk, insuring or re-insuring against risk and providing client service.

- Intra-group holding activities^{54 55}, excluding pure equity holding companies⁵⁶ which only hold equity participations and earn only dividends and capital gains or incidental income; or
- Co-ordination centres⁵⁷.

This list is neither absolute nor exhaustive. Every assessment against the third criterion of the Code of Conduct will continue to be based on a case-by-case approach, taking into account the specific nature of the regime.

2. Substantial economic presence

If the analysis under 1 raises doubts as to whether the activities that are covered by a regime constitute real economic activities, an analysis of the requirements for substantial economic presence should be performed.

The main elements of this analysis to be carried out by the Code of Conduct Group are requirements for an adequate number of employees with necessary qualifications and an adequate amount of operating expenditure with regard to the core income generating activities (see for example footnotes 2-4 and 6-7).

⁵⁴ The income generating activity could be such that is associated with income from for instance interest, rents and royalties

⁵⁵ In the 1999 "Code of Conduct Group report" the following is stated in paragraph 48: "*The Group noted that there can be commercial reasons why a multi-national enterprise may have a particular holding company within its corporate structure. But the Group also noted that many holding companies are set up wholly or mainly for tax planning reasons. In particular, holding companies may be used as a tax efficient holding point for profits or as a tax efficient conduit. Holding companies that are tax-driven normally have little or no economic substance, and may be no more than brass plate companies. They are therefore potentially highly mobile, and business taxation measures can have a significant effect on their location in the Community.*"

⁵⁶ Pure equity holding companies must respect all applicable corporate law filing requirements in order to meet the substantial activities requirement and it is suggested that they should have the people and the premises for holding and managing equity participations. Since such regimes are provided to avoid double taxation, there should be no expectation of a correlation between income-generating activities and benefits.

⁵⁷ The income generating activity could cover taking relevant management decisions, incurring expenditure on behalf of group entities and co-ordinating group activities.

The analysis of the two above-mentioned requirements can where appropriate take into account one or more of the following factors that may be present in the national regime:

- a statistical analysis of the average number of employees, where account would also need to be taken of the nature of the activities, e.g. whether it is a capital or labour-intensive industry;
- an analysis of whether the requirement of the regime is for full-time or part time jobs;
- an analysis of whether the regime requires that the qualifications of employees are related or adapted to the nature of the activity benefiting from the regime;
- an analysis of quantitative and qualitative aspects of the management and the administration of the entity;
- an analysis of the character of premises for the activity at issue and whether they are adequate for such activity (for instance investments made to carry out the activity concerned, the organizational structure including a management of resources consistent with the nature of the activity).

The list of factors above should not be seen as exhaustive.

Since every regime has different features, consideration of how the economic presence requirement applies must take place in the context of the regime being considered. As such, the degree of substantial economic presence that may be appropriate for one regime will not necessarily be adequate in the context of another regime. Due consideration could also be given to assessments carried out by the FHTP of the regime in question, where appropriate.

3. Nexus requirement

There should be an adequate de jure and de facto link between real economic activity carried on by entities covered by the tax privilege at issue and the profits for which that benefit is granted.

12. Audit requirements

Taking into account the potential risks, there should be tax audits verifying that the activities of the entities benefitting from the regime at issue meet the requirements of this Guidance.

These audits should be carried out regularly on a similar basis as that generally applied in the Member State in question.

13. Monitoring of regimes

Regimes that have been subject to an assessment based on this guidance will be monitored on their substance requirements. Regimes for which the Group has agreed before this guidance enters into force that there was no need to assess them or that have been assessed not harmful, will not be affected by the monitoring.

Such monitoring will consist for Member States as well as third countries of providing each year to the Code of Conduct Group data that shows how in practice regimes are implemented and that the core income generating activities are undertaken by the taxpayer. On the basis of the data provided, or its absence, the Code of Conduct Group may decide whether it is appropriate to reopen a review of the regime concerned.

The following data should be provided⁵⁸:

- the number of taxpayers applying for the regime,
- the number of taxpayers benefiting from the regime,
- the type of core activities undertaken by taxpayers benefiting from the regime,

⁵⁸ The monitoring provided in the following bullet points would be carried out for fiscal years commencing in 2019. For earlier years, countries would be asked to report data points that they have available, which would be collected together with other data points on monitoring.

- the quantity of core activities undertaken by taxpayers benefiting from the regime (as measured by the number of full-time employees⁵⁹ with necessary qualifications and the amount of operating expenditures associated with these activities),
- the aggregate amount of net income benefiting from the regime (as discussed above, for regimes which do not have income reporting because they implement a non-income based tax in place of income tax or where such data is not collected as part of the tax return or is not otherwise easily obtainable, accounting profits or other similar statistics can be reported instead), and
- the number of taxpayers, if any, that no longer qualify for benefits in whole or in part under the regime.

As a case-by-case approach is the basis of the Code of Conduct Group's work, the data that needs to be provided each year shall be adapted to the individual regimes concerned. The Code of Conduct Group may specify the type of data to be communicated before the end of the assessment of the regime concerned. Such data requirements may also be modified on request by the Code of Conduct Group at any time during the monitoring procedure.

In order to reduce administrative burden and avoid double work, monitoring should be coordinated with the parallel monitoring by the OECD Forum on Harmful Tax Practices to the extent that is relevant.

⁵⁹ The number of full-time employees could include the part-time employees, whose aggregated working hours is divided by full-time work hours.

In order to reduce the administrative burden of collecting the required information, monitoring would be required only with respect to taxpayers that are members of multinational enterprise groups with annual revenues in the preceding year of EUR 750 million or more, unless decided otherwise by the Code of Conduct Group with a view to particular risks. Moreover, monitoring will not be required if the small number of taxpayers benefitting from a regime means that provision of the above information would have the effect of disclosing the identity of the taxpayer, and jurisdictions could establish de minimis exceptions to the monitoring requirement to prevent such disclosure. Finally, pure equity holding companies would not be subject to this type of monitoring for the reasons discussed above.

BEPS MINIMUM STANDARDS IMPLEMENTATION: AGREED BENCHMARKS⁶⁰

A	B	C	D
Minimum Standard	Summary	Benchmarks for implementation	Steps in the review process by the Code of Conduct
Action 5 (exchange of rulings)	<p>Requires, in relation to the work on harmful tax practices with a focus on improving transparency:</p> <ul style="list-style-type: none"> i. compulsory spontaneous exchange on rulings within the scope of Action 5, and ii. requiring substantial activity for preferential regimes, such as IP regimes <p>Jurisdictions should exchange rulings pursuant to tax treaties, tax information exchange agreements and the multilateral Convention on Mutual Administrative Assistance in Tax Matters (MAC).</p>	<p>2018: provide information on:</p> <ul style="list-style-type: none"> - tax rulings within the scope of Action 5 in relation to Member States - other jurisdictions for which these rulings are relevant, <p>Should the minimum standard be relevant for the jurisdiction, provide information on:</p> <ul style="list-style-type: none"> - legal framework (domestic and international instruments) in place for the spontaneous exchange of information. <p>If applicable, in 2019 and later:</p> <ul style="list-style-type: none"> - amend legislation as needed to implement the minimum standard - ensure that the appropriate administrative practices are in place - actual exchanges according to the template in the Action 5 Report 	<p>2018: determine if the standard is relevant to the jurisdiction</p> <p>If applicable, jurisdictions to identify the areas in their existing legal framework that need to be amended in order to be compliant with Action 5</p> <p>2019 and later:</p> <ul style="list-style-type: none"> - review draft legislative proposals - monitor the application of the standard in relation to Member States

⁶⁰ Endorsed by the Council on 4 December 2018 (doc. 14364/18).

<p>Action 6 (treaty abuse)</p>	<p>Requires countries to include in their tax treaties an express statement that their common intention is to eliminate double taxation without creating opportunities for non-taxation or reduced taxation through tax evasion or avoidance, including treaty-shopping arrangements, as well as one of the following provisions</p> <ol style="list-style-type: none"> i. the Principal Purposes Test (PPT) rule included in paragraph 26 of the Action 6 Report together with either the simplified or the detailed version of the Limitation-on-benefits (LOB) rule that appears in paragraph 25 of the Action 6 Report, as subsequently modified, or ii. the Principal Purposes Test (PPT) rule included in paragraph 26 of the Report, or iii. the detailed version of the Limitation-on-benefits (LOB) rule that appears in paragraph 25 of the Report, as subsequently modified, together with a mechanism (such as a treaty rule that might take the form of a PPT rule restricted to conduit arrangements, or 	<p>2018: provide relevant information on all existing tax treaties/agreements with Member States</p> <p>Should the minimum standard be relevant for the jurisdiction, the following elements would need to be assessed in 2019 and later:</p> <ul style="list-style-type: none"> - amend treaty provisions in treaties/agreements with all Member States as necessary by following one of the options prescribed by the minimum standard - ensure that any newly negotiated treaties/agreements with Member States are compliant with the standard 	<p>2018: determine if the standard is relevant to the jurisdiction</p> <p>If applicable, jurisdictions to identify the areas in their treaties that might need an update in order to be compliant with Action 6. 2019 and later:</p> <ul style="list-style-type: none"> - Monitoring as jurisdictions start implementing the minimum standard in relation to existing treaties/agreements with Member States (i.e. negotiate the amendments) - Monitoring as jurisdictions include the minimum standard in relation to future treaties/agreements with Member States as from 2019 <p>Concerned Member States should confirm that they have been approached by these jurisdictions with the aim to negotiate these amendments or new treaties in line with the standards</p>
--------------------------------	---	--	---

	<p>domestic anti-abuse rules or judicial doctrines that would achieve a similar result) that would deal with conduit arrangements not already dealt with in tax treaties.</p>		
<p>Action 13 (CbCR)</p>	<p>Requires country-by-country reporting for large MNEs (MNEs with total annual consolidated group revenue of EUR 750 million) according to the standard, in particular: CbC report is to be filed in the jurisdiction where the ultimate parent of the MNE is located containing information relating to the global allocation, by jurisdiction where the MNE group operates, of certain key indicators of economic activity such as income, profit, taxes paid, accumulated earnings, stated capital, number of employees, activities and tangible assets. The CbC report is intended to be automatically exchanged with the tax administrators in each jurisdiction in which the MNE group conducts business.</p> <p>The Action 13 Final Report included an implementation package containing model legislation relating to CbC reporting, three model competent authority agreements to facilitate the exchange of CbC reports and a common template for the CbC report. The Final Report on Action 13 also</p>	<p>2018: Mapping of companies to verify the relevance of the standard.</p> <p>Should the standard be relevant, the timeline as envisaged for the new criterion 3.2 (ST 10823 2018 INIT) will apply:</p> <ul style="list-style-type: none"> - End-2019: have in place the domestic legal and administrative framework - End-2020: tax administration actually automatically exchanges CbC reports in full compliance with all relevant Member States 	<p>2018: identify the number of concerned MNEs to determine the relevance of the standard</p> <p>If applicable, jurisdictions to identify the areas in their existing legal framework that need to be amended in order to be compliant with Action 13</p> <p>2019 and later:</p> <ul style="list-style-type: none"> - review of the domestic and administrative framework - monitor the application of the minimum standard in relation to Member States

	recommended that domestic legislation require the master file and the local file to be filed directly with the local tax administrators and the ultimate parent of the MNE group be required to file the CbC report in its jurisdiction of residence.		
Action 14 (DRM)	<p>Requires jurisdictions to develop solutions to address obstacles that prevent countries from solving treaty-related disputes under MAP (arbitration as a voluntary option). In particular, treaties should provide for:</p> <ul style="list-style-type: none"> • Preventing Disputes • Availability and access to MAP • Resolution of MAP cases • Implementation of MAP agreements 	<p>2018:</p> <ul style="list-style-type: none"> - provide relevant information on all existing tax treaties/agreements with Member States <p>Should the minimum standard be relevant for the jurisdiction, the following elements would need to be assessed in 2019 and later:</p> <ul style="list-style-type: none"> - amend treaty provisions in treaties/agreements with all Member States as necessary - provide annual MAP statistics in relation to all MS according to the OECD format starting in 2019. 	<p>2018: determine if the standard is relevant to the jurisdiction</p> <p>If applicable, jurisdictions to identify the areas in their existing treaties that need to be amended in order to be compliant with Action 14</p> <p>2019 and later:</p> <ul style="list-style-type: none"> - Monitoring as jurisdictions start implementing the standard in relation to existing treaties/agreements with MS (i.e. negotiate the amendments) - Monitoring as jurisdictions include the standard in relation to future treaties/agreements with Member States as from 2019

GUIDANCE ON CRITERION 3.2 OF THE EU LISTING EXERCISE⁶¹

“With respect to the Country-by-country reporting BEPS Action 13 minimum standard (the 'CbCR minimum standard'), the jurisdiction should have arrangements in place to be able to exchange with all Member States when this is relevant either by signing the CbCR MCAA, or through bilateral agreements with those Member States. The domestic legal and administrative frameworks should be in place beforehand and should correspond to the CbCR minimum standard as detailed in the Terms of Reference.

Deadline for implementing the CbCR minimum standard:

- Jurisdictions that joined the Inclusive Framework on BEPS (IF) in the last years, should have effectively implemented the CbCR minimum standard by the end of 2019;
- Jurisdictions that committed to the CbCR minimum standard by the end of 2018 (2019) should have effectively implemented it by the end of 2020 (2021).

Furthermore, in the context of reviews by the IF:

- a) The absence of recommendations will be considered as a positive assessment.
- If a jurisdiction receives recommendations or if it has items being monitored, which do not consist in a material shortcoming, this will also be considered as a positive assessment.
 - A material shortcoming concerning the implementation of the CbCR minimum standard is defined as a significant non-compliance relating to the confidentiality, the data safeguards and the appropriate use, or as a failure to provide timely or adequate information as requested by the CbCR minimum standard. In this case the jurisdiction cannot be considered as compliant with criterion 3.2.

⁶¹ Endorsed by the Council on 4 December 2018 (doc. 14363/18).

- Where a jurisdiction receives a recommendation which constitutes a material shortcoming, the Code of Conduct Group will seek a commitment to address this shortcoming within 12 months.

For those jurisdictions which are not members of the IF and not part of the peer review process, the Commission services will monitor (in close consultation with the relevant OECD groups and bodies) the implementation of the CbCR minimum standard and submit draft assessments to the Code of Conduct Group."
