



Brussels, 27.12.2020  
COM(2020) 856 final/3

ANNEX 1

**CORRIGENDUM**

This document corrects document COM(2020) 856 final/2 of 26 December 2020.  
The text shall read as follows:

**ANNEX**

*to the*

**Proposal for a Council Decision**

**on the conclusion, on behalf of the Union, of the Trade and Cooperation Agreement between the European Union and the European Atomic Energy Community, of the one part, and the United Kingdom of Great Britain and Northern Ireland, of the other part, and of the Agreement between the European Union and the United Kingdom of Great Britain and Northern Ireland concerning security procedures for exchanging and protecting classified information**

TRADE AND COOPERATION AGREEMENT BETWEEN THE EUROPEAN UNION AND THE  
EUROPEAN ATOMIC ENERGY COMMUNITY, OF THE ONE PART, AND THE UNITED KINGDOM  
OF GREAT BRITAIN AND NORTHERN IRELAND, OF THE OTHER PART

PREAMBLE.....	6
<b>PART ONE: COMMON AND INSTITUTIONAL PROVISIONS .....</b>	<b>9</b>
Title I: General provisions .....	9
Title II: Principles of interpretation and definitions.....	9
Title III: Institutional framework .....	10
<b>PART TWO: TRADE, TRANSPORT, FISHERIES AND OTHER ARRANGEMENTS.....</b>	<b>18</b>
HEADING ONE: TRADE .....	18
Title I: Trade in goods.....	18
Title II: Services and investment .....	74
Title III: Digital trade.....	116
Title IV: Capital movements, payments, transfers and temporary safeguard measures .....	123
Title V: Intellectual property .....	125
Title VI: Public procurement .....	148
Title VII: Small and medium-sized enterprises.....	153
Title VIII: Energy .....	156
Title IX: Transparency.....	172
Title X: Good regulatory practices and regulatory cooperation .....	174
Title XI: Level playing field for open and fair competition and sustainable development .....	179
Title XII: Exceptions .....	217
HEADING TWO: AVIATION .....	221
Title I: Air transport.....	221
Title II: Aviation safety .....	240
HEADING THREE: ROAD TRANSPORT.....	246
Title I: Transport of goods by road.....	246
Title II: Transport of passengers by road .....	252
HEADING FOUR: SOCIAL SECURITY COORDINATION AND VISAS FOR SHORT-TERM VISITS.....	260
Title I: Social security coordination.....	260
Title II: Visas for short-term visits .....	260
HEADING FIVE: FISHERIES .....	261
HEADING SIX: OTHER PROVISIONS .....	275
<b>PART THREE: LAW ENFORCEMENT AND JUDICIAL COOPERATION IN CRIMINAL MATTERS .....</b>	<b>282</b>
Title I: General provisions .....	282
Title II: Exchanges of DNA, fingerprints and vehicle registration data .....	285
Title III: Transfer and processing of passenger name record data.....	290
Title IV: Cooperation on operational information .....	301
Title V: Cooperation with Europol .....	302

Title VI: Cooperation with Eurojust.....	308
Title VII: Surrender .....	312
Title VIII: Mutual assistance .....	329
Title IX: Exchange of criminal record information .....	333
Title X: Anti-money laundering and counter terrorist financing.....	336
Title XI: Freezing and confiscation .....	339
Title XII: Other provisions.....	353
Title XIII: Dispute settlement .....	358
<b>PART FOUR: THEMATIC COOPERATION.....</b>	<b>362</b>
Title I: Health security .....	362
Title II: Cyber security .....	363
<b>PART FIVE: PARTICIPATION IN UNION PROGRAMMES, SOUND FINANCIAL MANAGEMENT AND FINANCIAL PROVISIONS .....</b>	<b>365</b>
<b>PART SIX: DISPUTE SETTLEMENT AND HORIZONTAL PROVISIONS .....</b>	<b>383</b>
Title I: Dispute settlement .....	383
Title II: Basis for cooperation .....	397
Title III: Fulfillment of obligations and safeguard measures.....	400
<b>PART SEVEN: FINAL PROVISIONS .....</b>	<b>402</b>
<b>ANNEXES .....</b>	<b>410</b>
ANNEX INST: RULES OF PROCEDURE OF THE PARTNERSHIP COUNCIL AND COMMITTEES .....	410
ANNEX ORIG-1: INTRODUCTORY NOTES TO PRODUCT-SPECIFIC RULES OF ORIGIN .....	415
ANNEX ORIG-2: PRODUCT SPECIFIC RULES OF ORIGIN.....	423
ANNEX ORIG-2A: ORIGIN QUOTAS AND ALTERNATIVES TO THE PRODUCT-SPECIFIC RULES OF ORIGIN IN ANNEX ORIG-2 [PRODUCT-SPECIFIC RULES OF ORIGIN].....	471
ANNEX ORIG-2B: TRANSITIONAL PRODUCT-SPECIFIC RULES FOR ELECTRIC ACCUMULATORS AND ELECTRIFIED VEHICLES .....	474
ANNEX ORIG-3: SUPPLIER'S DECLARATION .....	478
ANNEX ORIG-4: TEXT OF THE STATEMENT ON ORIGIN .....	482
ANNEX ORIG-5: JOINT DECLARATION CONCERNING THE PRINCIPALITY OF ANDORRA .....	484
ANNEX ORIG-6: JOINT DECLARATION CONCERNING THE REPUBLIC OF SAN MARINO .....	485
ANNEX SPS-1: CRITERIA REFERRED TO IN ARTICLE SPS.19(d).....	486
ANNEX TBT-1: MOTOR VEHICLES AND EQUIPMENT AND PARTS THEREOF .....	487
ANNEX TBT-2: MEDICINAL PRODUCTS.....	492
ANNEX TBT-3: CHEMICALS.....	504
ANNEX TBT-4: ORGANIC PRODUCTS.....	507
ANNEX-TBT-5: TRADE IN WINE .....	515

ANNEX TBT-XX – ARRANGEMENT REFERRED TO IN ARTICLE TBT.9(4) FOR THE REGULAR EXCHANGE OF INFORMATION IN RELATION TO THE SAFETY OF NON-FOOD PRODUCTS AND RELATED PREVENTIVE, RESTRICTIVE AND CORRECTIVE MEASURES.....	523
ANNEX TBT-ZZ – ARRANGEMENT REFERRED TO IN ARTICLE TBT.9(5) FOR THE REGULAR EXCHANGE OF INFORMATION REGARDING MEASURES TAKEN ON NON-COMPLIANT NON-FOOD PRODUCTS, OTHER THAN THOSE COVERED BY ARTICLE TBT.9(4) .....	524
ANNEX CUSTMS-1: AUTHORISED ECONOMIC OPERATORS.....	525
ANNEX SERVIN-1: EXISTING MEASURES .....	530
ANNEX SERVIN-2: FUTURE MEASURES .....	644
ANNEX SERVIN-3: BUSINESS VISITORS FOR ESTABLISHMENT PURPOSES, INTRA-CORPORATE TRANSFEREES AND SHORT-TERM BUSINESS VISITORS.....	741
ANNEX SERVIN-4: CONTRACTUAL SERVICE SUPPLIERS AND INDEPENDENT PROFESSIONALS.....	747
ANNEX SERVIN-5: MOVEMENT OF NATURAL PERSONS .....	768
ANNEX SERVIN-6: GUIDELINES FOR ARRANGEMENTS ON THE RECOGNITION OF PROFESSIONAL QUALIFICATIONS .....	770
ANNEX PPROC-1: PUBLIC PROCUREMENT.....	775
ANNEX ENER-1: LISTS OF ENERGY GOODS, HYDROCARBONS AND RAW MATERIALS.....	780
ANNEX ENER-2: ENERGY AND ENVIRONMENTAL SUBSIDIES.....	782
ANNEX ENER-3: NON-APPLICATION OF THIRD-PARTY ACCESS AND OWNERSHIP UNBUNDLING TO INFRASTRUCTURE .....	783
ANNEX ENER-4: ALLOCATION OF ELECTRICITY INTERCONNECTOR CAPACITY AT THE DAY-AHEAD MARKET TIMEFRAME.....	784
ANNEX AVSAF-1: AIRWORTHINESS AND ENVIRONMENT CERTIFICATION .....	786
ANNEX ROAD-1: TRANSPORT OF GOODS BY ROAD .....	800
ANNEX ROAD-2: MODEL OF AUTHORISATION FOR AN INTERNATIONAL REGULAR AND SPECIAL REGULAR SERVICE .....	885
ANNEX ROAD-3: MODEL OF APPLICATION FOR AN AUTHORISATION FOR AN INTERNATIONAL REGULAR AND SPECIAL REGULAR SERVICE.....	889
ANNEX ROAD-4: MODEL OF JOURNEY FORM FOR OCCASIONAL SERVICES .....	891
ANNEX FISH.1 .....	893
ANNEX FISH.2 .....	896
ANNEX FISH.3 .....	898
ANNEX FISH.4: PROTOCOL ON ACCESS TO WATERS.....	899
ANNEX LAW-1: EXCHANGES OF DNA, FINGERPRINTS AND VEHICLE REGISTRATION DATA .....	900
ANNEX LAW-2: PASSENGER NAME RECORD DATA.....	992
ANNEX LAW-3: FORMS OF CRIME FOR WHICH EUROPOL IS COMPETENT.....	994
ANNEX LAW-4: FORMS OF SERIOUS CRIME FOR WHICH EUROJUST IS COMPETENT.....	996
ANNEX LAW-5: ARREST WARRANT .....	998
ANNEX LAW-6: EXCHANGE OF CRIMINAL RECORD INFORMATION – TECHNICAL AND PROCEDURAL SPECIFICATIONS .....	1006

ANNEX LAW-7: DEFINITION OF TERRORISM.....	1029
ANNEX LAW-8: FREEZING AND CONFISCATION.....	1033
ANNEX UNPRO-1: IMPLEMENTATION OF THE FINANCIAL CONDITIONS.....	1050
ANNEX INST: RULES OF PROCEDURE FOR DISPUTE SETTLEMENT.....	1053
ANNEX INST: CODE OF CONDUCT FOR ARBITRATORS.....	1059
<b>PROTOCOL ON ADMINISTRATIVE COOPERATION AND COMBATING FRAUD IN THE FIELD OF VALUE ADDED TAX AND ON MUTUAL ASSISTANCE FOR THE RECOVERY OF CLAIMS RELATING TO TAXES AND DUTIES.....</b>	<b>1062</b>
TITLE I: GENERAL PROVISIONS.....	1062
TITLE II: ADMINISTRATIVE COOPERATION AND COMBATING VAT FRAUD.....	1066
TITLE III: RECOVERY ASSISTANCE.....	1071
TITLE IV: IMPLEMENTATION AND APPLICATION.....	1080
TITLE V: FINAL PROVISIONS.....	1081
ANNEX TO THE PROTOCOL ON ADMINISTRATIVE COOPERATION AND COMBATING FRAUD IN THE FIELD OF VALUE ADDED TAX AND ON MUTUAL ASSISTANCE FOR THE RECOVERY OF CLAIMS RELATING TO TAXES AND DUTIES.....	1082
<b>PROTOCOL ON MUTUAL ADMINISTRATIVE ASSISTANCE IN CUSTOMS MATTERS.....</b>	<b>1126</b>
<b>PROTOCOL ON SOCIAL SECURITY COORDINATION.....</b>	<b>1132</b>
TITLE I: GENERAL PROVISIONS.....	1132
TITLE II: DETERMINATION OF THE LEGISLATION APPLICABLE.....	1138
TITLE III: SPECIAL PROVISIONS CONCERNING THE VARIOUS CATEGORIES OF BENEFITS.....	1142
TITLE IV: MISCELLANEOUS PROVISIONS.....	1159
TITLE V: FINAL PROVISIONS.....	1162
ANNEX SSC-1: CERTAIN BENEFITS IN CASH TO WHICH THE PROTOCOL SHALL NOT APPLY.....	1164
ANNEX SSC-2: RESTRICTION OF RIGHTS TO BENEFITS IN KIND FOR MEMBERS OF THE FAMILY OF A FRONTIER WORKER.....	1179
ANNEX SSC-3: MORE RIGHTS FOR PENSIONERS RETURNING TO THE COMPETENT STATE.....	1180
ANNEX SSC-4: CASES IN WHICH THE PRO RATA CALCULATION SHALL BE WAIVED OR SHALL NOT APPLY.....	1181
ANNEX SSC-5: BENEFITS AND AGREEMENTS WHICH ALLOW THE APPLICATION OF ARTICLE SSC.49 [Overlapping of benefits of the same kind].....	1186
ANNEX SSC-6: SPECIAL PROVISIONS FOR THE APPLICATION OF THE LEGISLATION OF THE MEMBER STATES AND OF THE UNITED KINGDOM.....	1189
ANNEX SSC-7: IMPLEMENTING PART.....	1202
ANNEX SSC-8: TRANSITIONAL PROVISIONS REGARDING THE APPLICATION OF ARTICLE SSC.11 [Detached workers].....	1246

TRADE AND COOPERATION AGREEMENT BETWEEN THE EUROPEAN UNION AND THE EUROPEAN ATOMIC ENERGY COMMUNITY, OF THE ONE PART, AND THE UNITED KINGDOM OF GREAT BRITAIN AND NORTHERN IRELAND, OF THE OTHER PART

PREAMBLE

THE EUROPEAN UNION AND THE EUROPEAN ATOMIC ENERGY COMMUNITY

AND

THE UNITED KINGDOM OF GREAT BRITAIN AND NORTHERN IRELAND,

*REAFFIRMING their commitment to democratic principles, to the rule of law, to human rights, to countering proliferation of weapons of mass destruction and to the fight against climate change, which constitute essential elements of this and supplementing agreements,*

*RECOGNISING the importance of global cooperation to address issues of shared interest,*

*RECOGNISING the importance of transparency in international trade and investment to the benefit of all stakeholders,*

*SEEKING to establish clear and mutually advantageous rules governing trade and investment between the Parties,*

*CONSIDERING that in order to guarantee the efficient management and correct interpretation and application of this Agreement and any supplementing agreement as well as compliance with the obligations under those agreements, it is essential to establish provisions ensuring overall governance, in particular dispute settlement and enforcement rules that fully respect the autonomy of the respective legal orders of the Union and of the United Kingdom, as well as the United Kingdom's status as a country outside the European Union,*

*BUILDING upon their respective rights and obligations under the Marrakesh Agreement Establishing the World Trade Organization, done on 15 April 1994, and other multilateral and bilateral instruments of cooperation,*

*RECOGNISING the Parties' respective autonomy and rights to regulate within their territories in order to achieve legitimate public policy objectives such as the protection and promotion of public health, social services, public education, safety, the environment including climate change, public morals, social or consumer protection, animal welfare, privacy and data protection and the promotion and protection of cultural diversity, while striving to improve their respective high levels of protection,*

*BELIEVING in the benefits of a predictable commercial environment that fosters trade and investment between them and prevents distortion of trade and unfair competitive advantages, in a manner conducive to sustainable development in its economic, social and environmental dimensions,*

*RECOGNISING the need for an ambitious, wide-ranging and balanced economic partnership to be underpinned by a level playing field for open and fair competition and sustainable development, through effective and robust frameworks for subsidies and competition and a commitment to uphold their respective high levels of protection in the areas of labour and social standards, environment, the fight against climate change, and taxation,*

*RECOGNISING the need to ensure an open and secure market for businesses, including medium-sized enterprises, and their goods and services through addressing unjustified barriers to trade and investment,*

*NOTING the importance of facilitating new opportunities for businesses and consumers through digital trade, and addressing unjustified barriers to data flows and trade enabled by electronic means, whilst respecting the Parties' personal data protection rules,*

*DESIRING that this Agreement contributes to consumer welfare through policies ensuring a high level of consumer protection and economic well-being, as well as encouraging cooperation between relevant authorities,*

*CONSIDERING the importance of cross-border connectivity by air, by road and by sea, for passengers and for goods, and the need to ensure high standards in the provision of transportation services between the Parties,*

*RECOGNISING the benefits of trade and investment in energy and raw materials and the importance of supporting the delivery of cost efficient, clean and secure energy supplies to the Union and the United Kingdom,*

*NOTING the interest of the Parties in establishing a framework to facilitate technical cooperation and develop new trading arrangements for interconnectors which deliver robust and efficient outcomes for all timeframes,*

*NOTING that cooperation and trade between the Parties in these areas should be based on fair competition in energy markets and non-discriminatory access to networks,*

*RECOGNISING the benefits of sustainable energy, renewable energy, in particular offshore generation in the North Sea, and energy efficiency,*

*DESIRING to promote the peaceful use of the waters adjacent to their coasts and the optimum and equitable utilisation of the marine living resources in those waters including the continued sustainable management of the shared stocks,*

*NOTING that, the United Kingdom withdrew from the European Union and that with effect from 1 January 2021, the United Kingdom is an independent coastal State with corresponding rights and obligations under international law,*

*AFFIRMING that the sovereign rights of the coastal States exercised by the Parties for the purpose of exploring, exploiting, conserving and managing the living resources in their waters should be conducted pursuant to and in accordance with the principles of international law, including the United Nations Convention on the Law of the Sea of 10 December 1982,*

*RECOGNISING the importance of the coordination of social security rights enjoyed by persons moving between the Parties to work, to stay or to reside, as well as the rights enjoyed by their family members and survivors,*

*CONSIDERING that cooperation in areas of shared interest, such as science, research and innovation, nuclear research or space, in the form of the participation of the United Kingdom in the corresponding Union programmes under fair and appropriate conditions will benefit both Parties,*



*CONSIDERING that cooperation between the United Kingdom and the Union relating to the prevention, investigation, detection or prosecution of criminal offences and to the execution of criminal penalties, including the safeguarding against and prevention of threats to public security, will enable the security of the United Kingdom and the Union to be strengthened,*

*DESIRING that an agreement is concluded between the United Kingdom and the Union to provide a legal base for such cooperation,*

*ACKNOWLEDGING that the Parties may supplement this Agreement with other agreements forming an integral part of their overall bilateral relations as governed by this Agreement and that the Agreement on Security Procedures for Exchanging and Protecting Classified Information is concluded as such a supplementing agreement, and enables the exchange of classified information between the Parties under this Agreement or any other supplementing agreement,*

HAVE AGREED AS FOLLOWS:

## **PART ONE: COMMON AND INSTITUTIONAL PROVISIONS**

### *TITLE I: GENERAL PROVISIONS*

#### Article COMPROV.1: Purpose

This Agreement establishes the basis for a broad relationship between the Parties, within an area of prosperity and good neighbourliness characterised by close and peaceful relations based on cooperation, respectful of the Parties' autonomy and sovereignty.

#### Article COMPROV.2: Supplementing agreements

1. Where the Union and the United Kingdom conclude other bilateral agreements between them, such agreements shall constitute supplementing agreements to this Agreement, unless otherwise provided for in those agreements. Such supplementing agreements shall be an integral part of the overall bilateral relations as governed by this Agreement and shall form part of the overall framework.
2. Paragraph 1 also applies to:
  - (a) agreements between the Union and its Member States, of the one part, and the United Kingdom, of the other part; and
  - (b) agreements between Euratom, of the one part, and the United Kingdom, of the other part.

#### Article COMPROV.3: Good faith

1. The Parties shall, in full mutual respect and good faith, assist each other in carrying out tasks that flow from this Agreement and any supplementing agreement.
2. They shall take all appropriate measures, whether general or particular, to ensure the fulfilment of the obligations arising from this Agreement and from any supplementing agreement, and shall refrain from any measures which could jeopardise the attainment of the objectives of this Agreement or any supplementing agreement.

### *TITLE II: PRINCIPLES OF INTERPRETATION AND DEFINITIONS*

#### Article COMPROV.13: Public international law

1. The provisions of this Agreement and any supplementing agreement shall be interpreted in good faith in accordance with their ordinary meaning in their context and in light of the object and purpose of the agreement in accordance with customary rules of interpretation of public international law, including those codified in the Vienna Convention on the Law of Treaties, done at Vienna on 23 May 1969.
2. For greater certainty, neither this Agreement nor any supplementing agreement establishes an obligation to interpret their provisions in accordance with the domestic law of either Party.
3. For greater certainty, an interpretation of this Agreement or any supplementing agreement given by the courts of either Party shall not be binding on the courts of the other Party.

#### Article COMPROV.16: Private rights

1. Without prejudice to Article MOBI.SSC.67 [Protection of individual rights] and with the exception, with regard to the Union, of Part Three [Law enforcement and judicial cooperation ], nothing in this Agreement or any supplementing agreement shall be construed as conferring rights or imposing obligations on persons other than those created between the Parties under public international law, nor as permitting this Agreement or any supplementing agreement to be directly invoked in the domestic legal systems of the Parties.
2. A Party shall not provide for a right of action under its law against the other Party on the ground that the other Party has acted in breach of this Agreement or any supplementing agreement.

#### Article COMPROV.17: Definitions

1. For the purposes of this Agreement and any supplementing agreement, and unless otherwise specified, the following definitions apply:
  - (a) “data subject” means an identified or identifiable natural person; an identifiable person being a person who can be identified, directly or indirectly, in particular by reference to an identifier such as a name, an identification number, location data or an online identifier, or to one or more factors specific to the physical, physiological, genetic, mental, economic, cultural or social identity of that natural person;
  - (b) “day” means a calendar day;
  - (c) “Member State” means a Member State of the European Union;
  - (d) “personal data” means any information relating to a data subject;
  - (e) “State” means a Member State or the United Kingdom, as the context requires;
  - (f) “territory” of a Party means in respect of each Party the territories to which the Agreement applies in accordance with Article FINPROV.1 [Territorial scope];
  - (g) “the transition period” means the transition period provided for in Article 126 of the Withdrawal Agreement; and
  - (h) “Withdrawal Agreement” means the Agreement on the withdrawal of the United Kingdom of Great Britain and Northern Ireland from the European Union and the European Atomic Energy Community, including its Protocols.
2. Any reference to the “Union”, “Party” or “Parties” in this Agreement or any supplementing agreement shall be understood as not including the European Atomic Energy Community, unless otherwise specified or where the context otherwise requires.

### *TITLE III: INSTITUTIONAL FRAMEWORK*

#### Article INST.1: Partnership Council

1. A Partnership Council is hereby established. It shall comprise representatives of the Union and of the United Kingdom. The Partnership Council may meet in different configurations depending on the matters under discussion.

2. The Partnership Council shall be co-chaired by a Member of the European Commission and a representative of the Government of the United Kingdom at ministerial level. It shall meet at the request of the Union or the United Kingdom, and, in any event, at least once a year, and shall set its meeting schedule and its agenda by mutual consent.

3. The Partnership Council shall oversee the attainment of the objectives of this Agreement and any supplementing agreement. It shall supervise and facilitate the implementation and application of this Agreement and of any supplementing agreement. Each Party may refer to the Partnership Council any issue relating to the implementation, application and interpretation of this Agreement or of any supplementing agreement.

4. The Partnership Council shall have the power to:

- (a) adopt decisions in respect of all matters where this Agreement or any supplementing agreement so provides;
- (b) make recommendations to the Parties regarding the implementation and application of this Agreement or of any supplementing agreement;
- (c) adopt, by decision, amendments to this Agreement or to any supplementing agreement in the cases provided for in this Agreement or in any supplementing agreement;
- (d) except in relation to Title III [Institutional Framework] of Part One [Common and institutional provisions], until the end of the fourth year following the entry into force of this Agreement, adopt decisions amending this Agreement or any supplementing agreement, provided that such amendments are necessary to correct errors, or to address omissions or other deficiencies;
- (e) discuss any matter related to the areas covered by this Agreement or by any supplementing agreement;
- (f) delegate certain of its powers to the Trade Partnership Committee or to a Specialised Committee, except those powers and responsibilities referred to in point (g) of Article INST.1(4) [Partnership Council];
- (g) by decision, establish Trade Specialised Committees and Specialised Committees, other than those referred to in Article INST.2(1) [Committees], dissolve any Trade Specialised Committee or Specialised Committee, or change the tasks assigned to them; and
- (h) make recommendations to the Parties regarding the transfer of personal data in specific areas covered by this Agreement or any supplementing agreement.

5. The work of the Partnership Council shall be governed by the rules of procedure set out in ANNEX INST-1 [Rules of Procedure of the Partnership Council and Committees]. The Partnership Council may amend that Annex.

#### Article INST.2: Committees

1. The following Committees are hereby established:

- (a) the Trade Partnership Committee, which addresses matters covered by Titles I to VII, Chapter 4 [Energy goods and raw materials] of Title VIII, Titles IX to XII of Heading One [Trade] of Part Two, Heading Six [Other provisions] of Part Two, and Annex ENER-2 [ENERGY AND ENVIRONMENTAL SUBSIDIES];
- (b) the Trade Specialised Committee on Goods which addresses matters covered by Chapter 1 of Title I of Heading One of Part Two and Chapter four [Energy goods and raw materials] of Title VIII of Heading One of Part Two;
- (c) the Trade Specialised Committee on Customs Cooperation and Rules of Origin, which addresses matters covered by Chapters 2 and 5 of Title I of Heading One of Part Two, the Protocol on mutual administrative assistance in customs matters and the provisions on customs enforcement of intellectual property rights, fees and charges, customs valuation and repaired goods;
- (d) the Trade Specialised Committee on Sanitary and Phytosanitary Measures, which addresses matters covered by Chapter 3 of Title I of Heading One of Part Two;
- (e) the Trade Specialised Committee on Technical Barriers to Trade, which addresses matters covered by Chapter 4 of Title I of Heading One of Part Two and Article ENER.25 [Cooperation on standards] of Title VIII [Energy] of Heading One of Part Two;
- (f) the Trade Specialised Committee on Services, Investment and Digital Trade, which addresses matters covered by Titles II to IV of Heading One of Part Two and Chapter 4 [Energy Goods and Raw Materials] of Title VIII of Heading One of Part Two;
- (g) the Trade Specialised Committee on Intellectual Property, which addresses matters covered by Title V of Heading One of Part Two;
- (h) the Trade Specialised Committee on Public Procurement, which addresses matters covered by Title VI of Heading One of Part Two;
- (i) the Trade Specialised Committee on Regulatory Cooperation, which addresses matters covered by Title X of Heading One of Part Two;
- (j) the Trade Specialised Committee on Level Playing Field for Open and Fair Competition and Sustainable Development, which addresses matters covered by Title XI of Heading One of Part Two and Annex ENER-2 [ENERGY AND ENVIRONMENTAL SUBSIDIES];
- (k) the Trade Specialised Committee on Administrative Cooperation in VAT and Recovery of Taxes and Duties, which addresses matters covered by the Protocol on administrative cooperation and combating fraud in the field of Value Added Tax and on mutual assistance for the recovery of claims relating to taxes and duties;
- (l) the Specialised Committee on Energy,
  - (i) which addresses matters covered by Title VIII of Heading One of Part Two, with the exception of Chapter 4 [Energy Goods and Raw Materials], Article ENER.25 [Cooperation on Standards] and Annex ENER-2 [ENERGY AND ENVIRONMENTAL SUBSIDIES], and

- (ii) which can discuss and provide expertise to the relevant Trade Specialised Committee on matters pertaining to Chapter four [Energy Goods and Raw Materials] and Article ENER.25 [Cooperation on Standards] of Title VIII of Heading One of Part Two;
- (m) the Specialised Committee on Air Transport, which addresses matters covered by Title I of Heading Two of Part Two;
- (n) the Specialised Committee on Aviation Safety, which addresses matters covered by Title II of Heading Two of Part Two;
- (o) the Specialised Committee on Road Transport, which addresses matters covered by Heading Three [Road Transport] of Part Two;
- (p) the Specialised Committee on Social Security Coordination, which addresses matters covered by Heading Four of Part Two and the Protocol on Social Security Coordination;
- (q) the Specialised Committee on Fisheries, which addresses matters covered by Heading Five [Fisheries] of Part Two;
- (r) the Specialised Committee on Law Enforcement and Judicial Cooperation, which addresses matters covered by Part Three [Law enforcement and judicial cooperation in criminal matters]; and
- (s) the Specialised Committee on Participation in Union Programmes, which addresses matters covered by Part Five [Union programmes].

2. With respect to issues related to Titles I to VII, Chapter 4 [Energy goods and raw materials] of Title VIII, Titles IX to XII of Heading One [Trade] of Part Two, Heading Six [Other provisions] of Part Two and Annex ENER-2 [ENERGY AND ENVIRONMENTAL SUBSIDIES], the Trade Partnership Committee referred to in paragraph 1 of this Article shall have the power to:

- (a) assist the Partnership Council in the performance of its tasks and, in particular, report to the Partnership Council and carry out any task assigned to it by the latter;
- (b) supervise the implementation of this Agreement or any supplementing agreement;
- (c) adopt decisions or make recommendations as provided for in this Agreement or any supplementing agreement or where such power has been delegated to it by the Partnership Council;
- (d) supervise the work of the Trade Specialised Committees referred to in paragraph 1 of this Article;
- (e) explore the most appropriate way to prevent or solve any difficulty that may arise in relation to the interpretation and application of this Agreement or any supplementing agreement, without prejudice to Title I [Dispute settlement] of Part Six ;
- (f) exercise the powers delegated to it by the Partnership Council pursuant to point (f) of Article INST.1(4) [Partnership Council];

(g) establish, by decision, Trade Specialised Committees other than those referred to in paragraph 1 of this Article, dissolve any such Trade Specialised Committee, or change the tasks assigned to them; and

(h) establish, supervise, coordinate and dissolve Working Groups, or delegate their supervision to a Trade Specialised Committee.

3. With respect to issues related to their area of competence, Trade Specialised Committees shall have the power to:

(a) monitor and review the implementation and ensure the proper functioning of this Agreement or any supplementing agreement;

(b) assist the Trade Partnership Committee in the performance of its tasks and, in particular, report to the Trade Partnership Committee and carry out any task assigned to them by it;

(c) conduct the preparatory technical work necessary to support the functions of the Partnership Council and the Trade Partnership Committee, including when those bodies have to adopt decisions or recommendations;

(d) adopt decisions in respect of all matters where this Agreement or any supplementing agreement so provides;

(e) discuss technical issues arising from the implementation of this Agreement or of any supplementing agreement, without prejudice to Title I [Dispute Settlement] of Part Six; and

(f) provide a forum for the Parties to exchange information, discuss best practices and share implementation experience.

4. With respect to issues related to their area of competence, Specialised Committees shall have the power to:

(a) monitor and review the implementation and ensure the proper functioning of this Agreement or any supplementing agreement;

(b) assist the Partnership Council in the performance of its tasks and, in particular, report to the Partnership Council and carry out any task assigned to them by it;

(c) adopt decisions, including amendments, and recommendations in respect of all matters where this Agreement or any supplementing agreement so provides or for which the Partnership Council has delegated its powers to a Specialised Committee in accordance with point (f) of Article INST.1(4) [Partnership Council];

(d) discuss technical issues arising from the implementation of this Agreement or any supplementing agreement;

(e) provide a forum for the Parties to exchange information, discuss best practices and share implementation experience;

(f) establish, supervise, coordinate and dissolve Working Groups; and

- (g) provide a forum for consultation pursuant to Article INST.13(7) [Consultations] of Title I [Dispute Settlement] of Part Six.
5. Committees shall comprise representatives of each Party. Each Party shall ensure that its representatives on the Committees have the appropriate expertise with respect to the issues under discussion.
6. The Trade Partnership Committee shall be co-chaired by a senior representative of the Union and a representative of the United Kingdom with responsibility for trade-related matters, or their designees. It shall meet at the request of the Union or the United Kingdom, and, in any event, at least once a year, and shall set its meeting schedule and its agenda by mutual consent.
7. The Trade Specialised Committees and the Specialised Committees shall be co-chaired by a representative of the Union and a representative of the United Kingdom. Unless otherwise provided for in this Agreement, or unless the co-chairs decide otherwise, they shall meet at least once a year.
8. Committees shall set their meeting schedule and agenda by mutual consent.
9. The work of the Committees shall be governed by the rules of procedure set out in ANNEX INST-X [Rules of Procedure of the Partnership Council and Committees].
10. By derogation from paragraph 9, a Committee may adopt and subsequently amend its own rules that shall govern its work.

#### Article INST.3: Working Groups

1. The following Working Groups are hereby established:
- (a) the Working Group on Organic Products, under the supervision of the Trade Specialised Committee on Technical Barriers to Trade;
  - (b) the Working Group on Motor Vehicles and Parts, under the supervision of the Trade Specialised Committee on Technical Barriers to Trade;
  - (c) the Working Group on Medicinal Products, under the supervision of the Trade Specialised Committee on Technical Barriers to Trade;
  - (d) the Working Group on Social Security Coordination, under the supervision of the Specialised Committee on Social Security Coordination;
2. Working Groups shall, under the supervision of Committees, assist Committees in the performance of their tasks and, in particular, prepare the work of Committees and carry out any task assigned to them by the latter.
3. Working Groups shall comprise representatives of the Union and of the United Kingdom and shall be co-chaired by a representative of the Union and a representative of the United Kingdom.
4. Working Groups shall set their own rules of procedure, meeting schedule and agenda by mutual consent.



#### Article INST.4: Decisions and recommendations

1. The decisions adopted by the Partnership Council, or, as the case may be, by a Committee, shall be binding on the Parties and on all the bodies set up under this Agreement and under any supplementing agreement, including the arbitration tribunal referred to in Title I [Dispute settlement] of Part Six. Recommendations shall have no binding force.
2. The Partnership Council or, as the case may be, a Committee, shall adopt decisions and make recommendations by mutual consent.

#### Article INST.5: Parliamentary cooperation

1. The European Parliament and the Parliament of the United Kingdom may establish a Parliamentary Partnership Assembly consisting of Members of the European Parliament and of Members of the Parliament of the United Kingdom, as a forum to exchange views on the partnership.
2. Upon its establishment, the Parliamentary Partnership Assembly:
  - (a) may request relevant information regarding the implementation of this Agreement and any supplementing agreement from the Partnership Council, which shall then supply that Assembly with the requested information;
  - (b) shall be informed of the decisions and recommendations of the Partnership Council; and
  - (c) may make recommendations to the Partnership Council.

#### Article INST.6: Participation of civil society

The Parties shall consult civil society on the implementation of this Agreement and any supplementing agreement, in particular through interaction with the domestic advisory groups and the Civil Society Forum referred to in Articles INST.7 [Domestic advisory groups] and INST.8 [Civil Society Forum].

#### Article INST.7: Domestic advisory groups

1. Each Party shall consult on issues covered by this Agreement and any supplementing agreement its newly created or existing domestic advisory group or groups comprising a representation of independent civil society organisations including non-governmental organisations, business and employers' organisations, as well as trade unions, active in economic, sustainable development, social, human rights, environmental and other matters. Each Party may convene its domestic advisory group or groups in different configurations to discuss the implementation of different provisions of this Agreement or of any supplementing agreement.
2. Each Party shall consider views or recommendations submitted by its domestic advisory group or groups. Representatives of each Party shall aim to consult with their respective domestic advisory group or groups at least once a year. Meetings may be held by virtual means.
3. In order to promote public awareness of the domestic advisory groups, each Party shall endeavour to publish the list of organisations participating in its domestic advisory group or groups as well as the contact point for that or those groups.

4. The Parties shall promote interaction between their respective domestic advisory groups, including by exchanging where possible the contact details of members of their domestic advisory groups.

#### Article INST.8: Civil Society Forum

1. The Parties shall facilitate the organisation of a Civil Society Forum to conduct a dialogue on the implementation of Part Two of this Agreement. The Partnership Council shall adopt operational guidelines for the conduct of the Forum.

2. The Civil Society Forum shall meet at least once a year, unless otherwise agreed by the Parties. The Civil Society Forum may meet by virtual means.

3. The Civil Society Forum shall be open for the participation of independent civil society organisations established in the territories of the Parties, including members of the domestic advisory groups referred to in Article INST.7 [Domestic advisory groups]. Each Party shall promote a balanced representation, including non-governmental organisations, business and employers' organisations and trade unions, active in economic, sustainable development, social, human rights, environmental and other matters.

## PART TWO: TRADE, TRANSPORT, FISHERIES AND OTHER ARRANGEMENTS

### HEADING ONE: TRADE

#### TITLE I: TRADE IN GOODS

##### Chapter 1: National treatment and market access for goods (including trade remedies)

###### Article GOODS.1: Objective

The objective of this Chapter is to facilitate trade in goods between the Parties and to maintain liberalised trade in goods in accordance with the provisions of this Agreement.

###### Article GOODS.2: Scope

Except as otherwise provided, this Chapter applies to trade in goods of a Party.

###### Article GOODS.3: Definitions

For the purposes of this Chapter, the following definitions apply:

- (a) “consular transactions” means the procedure of obtaining from a consul of the importing Party in the territory of the exporting Party, or in the territory of a third party, a consular invoice or a consular visa for a commercial invoice, certificate of origin, manifest, shipper’s export declaration or any other customs documentation in connection with the importation of the good;
- (b) “Customs Valuation Agreement” means the Agreement on Implementation of Article VII of GATT 1994;
- (c) “export licensing procedure” means an administrative procedure, whether or not referred to as licensing, used by a Party for the operation of export licensing regimes, requiring the submission of an application or other documentation, other than that generally required for customs clearance purposes, to the relevant administrative body as a prior condition for exportation from that Party;
- (d) “import licensing procedure” means an administrative procedure, whether or not referred to as licensing, used by a Party for the operation of import licensing regimes, requiring the submission of an application or other documentation, other than that generally required for customs clearance purposes, to the relevant administrative body or bodies as a prior condition for importation into the territory of the importing Party;
- (e) “originating goods” means, unless otherwise provided, a good qualifying under the rules of origin set out in Chapter 2 [Rules of origin] of this Title;
- (f) “performance requirement” means a requirement that:
  - (i) a given quantity, value or percentage of goods be exported;
  - (ii) goods of the Party granting an import licence be substituted for imported goods;

- (iii) a person benefiting from an import licence purchase other goods in the territory of the Party granting the import licence, or accord a preference to domestically produced goods;
  - (iv) a person benefiting from an import licence produce goods in the territory of the Party granting the import licence, with a given quantity, value or percentage of domestic content; or
  - (v) relates in whatever form to the volume or value of imports, to the volume or value of exports or to the amount of foreign exchange flows;
- (g) “remanufactured good” means a good classified in HS Chapters 32, 40, 84 to 90, 94 or 95 that:
- (i) is entirely or partially composed of parts obtained from used goods;
  - (ii) has similar life expectancy and performance compared with such goods, when new; and
  - (iii) is given an equivalent warranty to as that applicable to such goods when new; and
- (h) “repair” means any processing operation undertaken on a good to remedy operating defects or material damage and entailing the re-establishment of the good to its original function or to ensure compliance with technical requirements for its use. Repair of a good includes restoration and maintenance, with a possible increase in the value of the good from restoring the original functionality of that good, but does not include an operation or process that:
- (i) destroys the essential characteristics of a good, or creates a new or commercially different good;
  - (ii) transforms an unfinished good into a finished good; or
  - (iii) is used to improve or upgrade the technical performance of a good.

#### Article GOODS.3A: Classification of goods

The classification of goods in trade between the Parties under this Agreement is set out in each Party’s respective tariff nomenclature in conformity with the Harmonised System.

#### Article GOODS.4: National treatment on internal taxation and regulation

Each Party shall accord national treatment to the goods of the other Party in accordance with Article III of GATT 1994 including its Notes and Supplementary Provisions. To this end, Article III of GATT 1994 and its Notes and Supplementary Provisions are incorporated into and made part of this Agreement, *mutatis mutandis*.

#### Article GOODS.4A: Freedom of transit

Each Party shall accord freedom of transit through its territory, via the routes most convenient for international transit, for traffic in transit to or from the territory of the other Party or of any other third country. To this end, Article V of GATT 1994 and its Notes and Supplementary Provisions are incorporated into and made part of this Agreement, *mutatis mutandis*. The Parties understand that

Article V of GATT 1994 includes the movement of energy goods via *inter alia* pipelines or electricity grids.

#### Article GOODS.5: Prohibition of customs duties

Except as otherwise provided for in this Agreement, customs duties on all goods originating in the other Party shall be prohibited.

#### Article GOODS.6: Export duties, taxes or other charges

1. A Party may not adopt or maintain any duty, tax or other charge of any kind imposed on, or in connection with, the exportation of a good to the other Party; or any internal tax or other charge on a good exported to the other Party that is in excess of the tax or charge that would be imposed on like goods when destined for domestic consumption.
2. For the purpose of this Article, the term 'other charge of any kind' does not include fees or other charges that are permitted under Article GOODS.7 [Fees and formalities].

#### Article GOODS.7: Fees and formalities

1. Fees and other charges imposed by a Party on or in connection with importation or exportation of a good of the other Party shall be limited in amount to the approximate cost of the services rendered, and shall not represent an indirect protection to domestic goods or taxation of imports or exports for fiscal purposes. A Party shall not levy fees or other charges on or in connection with importation or exportation on an *ad valorem* basis.
2. Each Party may impose charges or recover costs only where specific services are rendered, in particular, but not limited to, the following:
  - (a) attendance, where requested, by customs staff outside official office hours or at premises other than customs premises;
  - (b) analyses or expert reports on goods and postal fees for the return of goods to an applicant, particularly in respect of decisions relating to binding information or the provision of information concerning the application of the customs laws and regulations;
  - (c) the examination or sampling of goods for verification purposes, or the destruction of goods, where costs other than the cost of using customs staff are involved; and
  - (d) exceptional control measures, if these are necessary due to the nature of the goods or to a potential risk.
3. Each Party shall promptly publish all fees and charges it imposes in connection with importation or exportation via an official website in such a manner as to enable governments, traders and other interested parties, to become acquainted with them. That information shall include the reason for the fee or charge for the service provided, the responsible authority, the fees and charges that will be applied, and when and how payment is to be made. New or amended fees and charges shall not be imposed until information in accordance with this paragraph has been published and made readily available.
4. A Party shall not require consular transactions, including related fees and charges, in connection with the importation of any good of the other Party.

#### Article GOODS.8: Repaired goods

1. A Party shall not apply a customs duty to a good, regardless of its origin, that re-enters the Party's territory after that good has been temporarily exported from its territory to the territory of the other Party for repair.
2. Paragraph 1 does not apply to a good imported in bond, into free trade zones, or in similar status, that is then exported for repair and is not re-imported in bond, into free trade zones, or in similar status.
3. A Party shall not apply a customs duty to a good, regardless of its origin, imported temporarily from the territory of the other Party for repair.

#### Article GOODS.9: Remanufactured goods

1. A Party shall not accord to remanufactured goods of the other Party treatment that is less favourable than that which it accords to equivalent goods in new condition.
2. Article GOODS.10 [Import and export restrictions] applies to import and export prohibitions or restrictions on remanufactured goods. If a Party adopts or maintains import and export prohibitions or restrictions on used goods, it shall not apply those measures to remanufactured goods.
3. A Party may require that remanufactured goods be identified as such for distribution or sale in its territory and that they meet all applicable technical requirements that apply to equivalent goods in new condition.

#### Article GOODS.10: Import and export restrictions

1. A Party shall not adopt or maintain any prohibition or restriction on the importation of any good of the other Party or on the exportation or sale for export of any good destined for the territory of the other Party, except in accordance with Article XI of GATT 1994, including its Notes and Supplementary Provisions. To this end, Article XI of GATT 1994 and its Notes and Supplementary Provisions are incorporated into and made part of this Agreement, *mutatis mutandis*.
2. A Party shall not adopt or maintain:
  - (a) export and import price requirements, except as permitted in enforcement of countervailing and anti-dumping duty orders and undertakings; or
  - (b) import licensing conditioned on the fulfilment of a performance requirement.

#### Article GOODS.11: Import and export monopolies

A Party shall not designate or maintain an import or export monopoly. For the purposes of this Article, import or export monopoly means the exclusive right or grant of authority by a Party to an entity to import a good from, or export a good to, the other Party.

#### Article GOODS. 13: Import licensing procedures

1. Each Party shall ensure that all import licensing procedures applicable to trade in goods between the Parties are neutral in application, and are administered in a fair, equitable, non-discriminatory and transparent manner.
2. A Party shall only adopt or maintain licensing procedures as a condition for importation into its territory from the territory of the other Party, if other appropriate procedures to achieve an administrative purpose are not reasonably available.
3. A Party shall not adopt or maintain any non-automatic import licensing procedure, unless it is necessary to implement a measure that is consistent with this Agreement. A Party adopting such non-automatic import licensing procedure shall indicate clearly the measure being implemented through that procedure.
4. Each Party shall introduce and administer any import licensing procedure in accordance with Articles 1 to 3 of the WTO Agreement on Import Licensing Procedures ('the Import Licensing Agreement'). To this end, Articles 1 to 3 of the Import Licensing Agreement are incorporated into and made part of this Agreement *mutatis mutandis*.
5. Any Party introducing or modifying any import licensing procedure shall make all relevant information available online on an official website. That information shall be made available, whenever practicable, at least 21 days prior to the date of the application of the new or modified licensing procedure and in any event no later than the date of application. That information shall contain the data required under Article 5 of the Import Licensing Agreement.
6. At the request of the other Party, a Party shall promptly provide any relevant information regarding any import licensing procedures that it intends to adopt or that it maintains, including the information referred to in Articles 1 to 3 of the Import Licensing Agreement.
7. For greater certainty, nothing in this Article requires a Party to grant an import licence, or prevents a Party from implementing its obligations or commitments under United Nations Security Council Resolutions or under multilateral non-proliferation regimes and import control arrangements.

#### Article GOODS. 14: Export licensing procedures

1. Each Party shall publish any new export licensing procedure, or any modification to an existing export licensing procedure, in such a manner as to enable governments, traders and other interested parties to become acquainted with them. Such publication shall take place, whenever practicable, 45 days before the procedure or modification takes effect, and in any case no later than the date such procedure or modification takes effect and, where appropriate, publication shall take place on any relevant government websites.
2. The publication of export licensing procedures shall include the following information:
  - (a) the texts of its export licensing procedures, or of any modifications it makes to those procedures;
  - (b) the goods subject to each licensing procedure;

- (c) for each procedure, a description of the process for applying for a licence and any criteria an applicant must meet to be eligible to apply for a licence, such as possessing an activity licence, establishing or maintaining an investment, or operating through a particular form of establishment in a Party's territory;
- (d) a contact point or points from which interested persons can obtain further information on the conditions for obtaining an export licence;
- (e) the administrative body or bodies to which an application or other relevant documentation are to be submitted;
- (f) a description of any measure or measures being implemented through the export licensing procedure;
- (g) the period during which each export licensing procedure will be in effect, unless the procedure remains in effect until withdrawn or revised in a new publication;
- (h) if the Party intends to use a licensing procedure to administer an export quota, the overall quantity and, if applicable, the value of the quota and the opening and closing dates of the quota; and
- (i) any exemptions or exceptions that replace the requirement to obtain an export licence, how to request or use those exemptions or exceptions, and the criteria for granting them.

3. Within 45 days after the date of entry into force of this Agreement, each Party shall notify the other Party of its existing export licensing procedures. Each Party shall notify to the other Party any new export licensing procedures and any modifications to existing export licensing procedures within 60 days of publication. The notification shall include a reference to the sources where the information required pursuant to paragraph 2 is published and shall include, where appropriate, the address of the relevant government websites.

4. For greater certainty, nothing in this Article requires a Party to grant an export licence, or prevents a Party from implementing its commitments under United Nations Security Council Resolutions as well as under multilateral non-proliferation regimes and export control arrangements including the Wassenaar Arrangement on Export Controls for Conventional Arms and Dual-Use Goods and Technologies, the Australia Group, the Nuclear Suppliers Group, and the Missile Technology Control Regime, or from adopting, maintaining or implementing independent sanctions regimes.

#### Article GOODS.15: Customs valuation

Each Party shall determine the customs value of goods of the other Party imported into its territory in accordance with Article VII of GATT 1994 and the Customs Valuation Agreement. To this end, Article VII of GATT 1994 including its Notes and Supplementary Provisions, and Articles 1 to 17 of the Customs Valuation Agreement including its Interpretative Notes, are incorporated into and made part of this Agreement, *mutatis mutandis*.

#### Article GOODS.16: Preference utilisation

1. For the purpose of monitoring the functioning of this Agreement and calculating preference utilisation rates, the Parties shall annually exchange import statistics for a 10 year-long period starting one year after the entry into force of this Agreement. Unless the Trade Partnership



Committee decides otherwise, this period shall be automatically extended for five years, and thereafter the Trade Partnership Committee may decide to extend it further.

2. The exchange of import statistics shall cover data pertaining to the most recent year available, including value and, where applicable, volume, at the tariff line level for imports of goods of the other Party benefitting from preferential duty treatment under this Agreement and for those that receive non-preferential treatment.

#### Article GOODS.17: Trade Remedies

1. The Parties affirm their rights and obligations under Article VI of GATT 1994, the Anti-Dumping Agreement, the SCM Agreement, Article XIX of GATT 1994, the Safeguards Agreement, and Article 5 of the Agreement on Agriculture.

2. Chapter 2 [Rules of origin] of this Title does not apply to anti-dumping, countervailing and safeguard investigations and measures.

3. Each Party shall apply anti-dumping and countervailing measures in accordance with the requirements of the Anti-Dumping Agreement and the SCM Agreement, and pursuant to a fair and transparent process.

4. Provided it does not unnecessarily delay the conduct of the investigation, each interested party in an anti-dumping or countervailing investigation<sup>1</sup> shall be granted a full opportunity to defend its interests.

5. Each Party's investigating authority may, in accordance with the Party's law, consider whether the amount of the anti-dumping duty to be imposed shall be the full margin of dumping or a lesser amount.

6. Each Party's investigating authority shall, in accordance with the Party's law, consider information provided as to whether imposing an anti-dumping or a countervailing duty would not be in the public interest.

7. A Party shall not apply or maintain, with respect to the same good, at the same time:

- (a) a measure pursuant to Article 5 of the Agreement on Agriculture; and
- (b) a measure pursuant to Article XIX of GATT 1994 and the Safeguards Agreement.

8. Title I [Dispute settlement] of Part Six does not apply to paragraphs 1 to 6 of this Article.

#### Article GOODS.18: Use of existing WTO tariff rate quotas

1. Products originating in one Party shall not be eligible to be imported into the other Party under existing WTO Tariff Rate Quotas ('TRQs') as defined in paragraph 2. This shall include those TRQs as being apportioned between the Parties pursuant to Article XXVIII GATT negotiations initiated by the European Union in WTO document G/SECRET/42/Add.2 and by the UK in WTO document G/SECRET/44 and as set out in each Party's respective internal legislation. For the

---

<sup>1</sup> For the purpose of this Article, interested parties shall be defined as per Article 6(11) of the Anti-dumping Agreement and Article 12.9 of the SCM Agreement.

purposes of this Article, the originating status of the products shall be determined on the basis of non-preferential rules of origin applicable in the importing Party.

2. For the purposes of paragraph 1, 'existing WTO TRQs' means those tariff rate quotas which are WTO concessions of the European Union included in the draft EU28 schedule of concessions and commitments under GATT 1994 submitted to the WTO in document G/MA/TAR/RS/506 as amended by documents G/MA/TAR/RS/506/Add.1 and G/MA/TAR/RS/506/Add.2.

#### Article GOODS.19: Measures in case of breaches or circumventions of customs legislation

1. The Parties shall co-operate in preventing, detecting and combating breaches or circumventions of customs legislation, in accordance with their obligations under Chapter 2 [Rules of origin] of this Title and the Protocol on mutual administrative assistance in customs matters. Each Party shall take appropriate and comparable measures to protect its own and the other Party's financial interests regarding the levying of duties on goods entering the customs territories of the United Kingdom or the Union.

2. Subject to the possibility of exemption for compliant traders under paragraph 7, a Party may temporarily suspend the relevant preferential treatment of the product or products concerned in accordance with the procedure laid down in paragraphs 3 and 4 if:

(a) that Party has made a finding, based on objective, compelling and verifiable information, that systematic and large-scale breaches or circumventions of customs legislation have been committed, and;

(b) the other Party repeatedly and unjustifiably refuses or otherwise fails to comply with the obligations referred to in paragraph 1.

3. The Party which has made a finding as referred to in paragraph 2 shall notify the Trade Partnership Committee and shall enter into consultations with the other Party within the Trade Partnership Committee with a view to reaching a mutually acceptable solution.

4. If the Parties fail to agree on a mutually acceptable solution within three months after the date of notification, the Party which has made the finding may decide to suspend temporarily the relevant preferential treatment of the product or products concerned. In this case, the Party which made the finding shall notify the temporary suspension, including the period during which it intends the temporary suspension to apply, to the Trade Partnership Committee without delay.

5. The temporary suspension shall apply only for the period necessary to counteract the breaches or circumventions and to protect the financial interests of the Party concerned, and in any case not for longer than six months. The Party concerned shall keep the situation under review and, where it decides that the temporary suspension is no longer necessary, it shall bring it to an end before the end of the period notified to the Trade Partnership Committee. Where the conditions that gave rise to the suspension persist at the expiry of the period notified to the Trade Partnership Committee, the Party concerned may decide to renew the suspension. Any suspension shall be subject to periodic consultations within the Trade Partnership Committee.

6. Each Party shall publish, in accordance with its internal procedures, notices to importers about any decision concerning temporary suspensions referred to in paragraphs 4 and 5.

7. Notwithstanding paragraph 4, if an importer is able to satisfy the importing customs authority that such products are fully compliant with the importing Party's customs legislation, the

requirements of this Agreement, and any other appropriate conditions related to the temporary suspension established by the importing Party in accordance with its laws and regulations, the importing Party shall allow the importer to apply for preferential treatment and recover any duties paid in excess of the applicable preferential tariff rates when the products were imported.

#### Article GOODS.20: Management of administrative errors

In case of systematic errors by the competent authorities or issues concerning the proper management of the preferential system at export, concerning notably the application of the provisions of Chapter 2 of this Title or the application of the Protocol on Mutual Administrative Assistance in Customs Matters, and if these errors or issues lead to consequences in terms of import duties, the Party facing such consequences may request the Trade Partnership Committee to examine the possibility of adopting decisions, as appropriate, to resolve the situation.

#### Article GOODS.21: Cultural property

1. The Parties shall cooperate in facilitating the return of cultural property illicitly removed from the territory of a Party, having regard to the principles enshrined in the UNESCO Convention on the Means of Prohibiting and Preventing the Illicit Import, Export and Transfer of Ownership of Cultural Property signed in Paris on 17 November 1970.
2. For the purposes of this Article:
  - (a) 'cultural property' means property classified or defined as being among the national treasures possessing artistic, historic or archaeological value under the respective rules and procedures of each Party; and
  - (b) 'illicitly removed from the territory of a Party' means:
    - (i) removed from the territory of a Party on or after 1 January 1993 in breach of that Party's rules on the protection of national treasures or in breach of its rules on the export of cultural property; or
    - (ii) not returned at the end of a period of lawful temporary removal or any breach of another condition governing such temporary removal, on or after 1 January 1993.
3. The competent authorities of the Parties shall cooperate with each other in particular by:
  - (a) notifying the other Party where cultural property is found in their territory and there are reasonable grounds for believing that the cultural property has been illicitly removed from the territory of the other Party;
  - (b) addressing requests of the other Party for the return of cultural property which has been illicitly removed from the territory of that Party;
  - (c) preventing any actions to evade the return of such cultural property, by means of any necessary interim measures; and
  - (d) taking any necessary measures for the physical preservation of cultural property which has been illicitly removed from the territory of the other Party.

4. Each Party shall identify a contact point responsible for communicating with the contact point of the other Party with respect to any matters arising under this Article, including with respect to the notifications and requests referred to in points (a) and (b) of paragraph 3.

5. The envisaged cooperation between the Parties shall involve the customs authorities of the Parties responsible for managing export procedures for cultural property as appropriate and necessary.

6. Title I [Dispute Settlement] of Part Six does not apply to this Article.

## Chapter 2: Rules of origin

### *Section 1: Rules of origin*

#### Article ORIG.1: Objective

The objective of this Chapter is to lay down the provisions determining the origin of goods for the purpose of application of preferential tariff treatment under this Agreement, and setting out related origin procedures.

#### Article ORIG.2: Definitions

For the purposes of this Chapter, the following definitions apply:

- (a) "classification" means the classification of a product or material under a particular chapter, heading, or sub-heading of the Harmonised System;
- (b) "consignment" means products which are either sent simultaneously from one exporter to one consignee or covered by a single transport document covering their shipment from the exporter to the consignee or, in the absence of such a document, by a single invoice;
- (c) "exporter" means a person, located in a Party, who, in accordance with the requirements laid down in the laws and regulations of that Party, exports or produces the originating product and makes out a statement on origin;
- (d) "importer" means a person who imports the originating product and claims preferential tariff treatment for it;
- (e) "material" means any substance used in the production of a product, including any components, ingredients, raw materials, or parts;
- (f) "non-originating material" means a material which does not qualify as originating under this Chapter, including a material whose originating status cannot be determined;
- (g) "product" means the product resulting from the production, even if it is intended for use as a material in the production of another product;
- (h) "production" means any kind of working or processing including assembly.

### Article ORIG.3: General requirements

1. For the purposes of applying the preferential tariff treatment by a Party to the originating good of the other Party in accordance with this Agreement, provided that the products satisfy all other applicable requirements of this Chapter, the following products shall be considered as originating in the other Party:
  - (a) products wholly obtained in that Party within the meaning of Article ORIG.5 [Wholly obtained products];
  - (b) products produced in that Party exclusively from originating materials in that Party; and
  - (c) products produced in that Party incorporating non-originating materials provided they satisfy the requirements set out in ANNEX ORIG-2 [Product-specific rules of origin].
2. If a product has acquired originating status, the non-originating materials used in the production of that product shall not be considered as non-originating when that product is incorporated as a material in another product.
3. The acquisition of originating status shall be fulfilled without interruption in the United Kingdom or the Union.

### Article ORIG.4: Cumulation of origin

1. A product originating in a Party shall be considered as originating in the other Party if that product is used as a material in the production of another product in that other Party.
2. Production carried out in a Party on a non-originating material may be taken into account for the purpose of determining whether a product is originating in the other Party.
3. Paragraphs 1 and 2 do not apply if the production carried out in the other Party does not go beyond the operations referred to in Article ORIG.7 [Insufficient production].
4. In order for an exporter to complete the statement on origin referred to in point (a) of Article ORIG.18(2) [Claim for preferential tariff treatment] for a product referred to in paragraph 2 of this Article, the exporter shall obtain from its supplier a supplier's declaration as provided for in Annex ORIG-3 [Supplier's declaration] or an equivalent document that contains the same information describing the non-originating materials concerned in sufficient detail to enable them to be identified.

### Article ORIG.5: Wholly obtained products

1. The following products shall be considered as wholly obtained in a Party:
  - (a) mineral products extracted or taken from its soil or from its seabed;
  - (b) plants and vegetable products grown or harvested there;
  - (c) live animals born and raised there;
  - (d) products obtained from live animals raised there;
  - (e) products obtained from slaughtered animals born and raised there;

- (f) products obtained by hunting or fishing conducted there;
- (g) products obtained from aquaculture there if aquatic organisms, including fish, molluscs, crustaceans, other aquatic invertebrates and aquatic plants are born or raised from seed stock such as eggs, roes, fry, fingerlings, larvae, parr, smolts or other immature fish at a post-larval stage by intervention in the rearing or growth processes to enhance production such as regular stocking, feeding or protection from predators;
- (h) products of sea fishing and other products taken from the sea outside any territorial sea by a vessel of a Party;
- (i) products made aboard of a factory ship of a Party exclusively from products referred to in point (h);
- (j) products extracted from the seabed or subsoil outside any territorial sea provided that they have rights to exploit or work such seabed or subsoil;
- (k) waste and scrap resulting from production operations conducted there;
- (l) waste and scrap derived from used products collected there, provided that those products are fit only for the recovery of raw materials;
- (m) products produced there exclusively from the products specified in points (a) to (l).

2. The terms “vessel of a Party” and “factory ship of a Party” in points (h) and (i) of paragraph 1 mean a vessel and factory ship which:

- (a) is registered in a Member State or in the United Kingdom;
- (b) sails under the flag of a Member State or of the United Kingdom; and
- (c) meets one of the following conditions:
  - (i) it is at least 50% owned by nationals of a Member State or of the United Kingdom; or
  - (ii) it is owned by legal persons which each:
    - (A) have their head office and main place of business in the Union or the United Kingdom; and
    - (B) are at least 50% owned by public entities, nationals or legal persons of a Member State or the United Kingdom.

#### Article ORIG.6: Tolerances

1. If a product does not satisfy the requirements set out in ANNEX ORIG-2 [Product-specific rules of origin] due to the use of a non-originating material in its production, that product shall nevertheless be considered as originating in a Party, provided that:

- (a) the total weight of non-originating materials used in the production of products classified under Chapters 2 and 4 to 24 of the Harmonised System, other than processed fishery products of Chapter 16, does not exceed 15% of the weight of the product;

- (b) the total value of non-originating materials for all other products, except for products classified under Chapters 50 to 63 of the Harmonised System does not exceed 10% of the ex-works price of the product; or
- (c) for a product classified under Chapters 50 to 63 of the Harmonised System, the tolerances set out in Note 7 and 8 of ANNEX ORIG-1 [Introductory Notes to the Product-Specific Rules of Origin] apply.

2. Paragraph 1 does not apply if the value or weight of non-originating materials used in the production of a product exceeds any of the percentages for the maximum value or weight of non-originating materials as specified in the requirements set out in ANNEX ORIG-2 [Product-specific rules of origin].

3. Paragraph 1 of this Article does not apply to products wholly obtained in a Party within the meaning of Article ORIG.5 [Wholly obtained products]. If ANNEX ORIG-2 [Product-specific rules of origin] requires that the materials used in the production of a product are wholly obtained, paragraphs 1 and 2 of this Article apply.

#### Article ORIG.7: Insufficient Production

1. Notwithstanding point (c) of Article ORIG.3(1) [General requirements], a product shall not be considered as originating in a Party if the production of the product in a Party consists only of one or more of the following operations conducted on non-originating materials:

- (a) preserving operations such as drying, freezing, keeping in brine and other similar operations where their sole purpose is to ensure that the products remain in good condition during transport and storage;<sup>2</sup>
- (b) breaking-up or assembly of packages;
- (c) washing, cleaning; removal of dust, oxide, oil, paint or other coverings;
- (d) ironing or pressing of textiles and textile articles;
- (e) simple painting and polishing operations;
- (f) husking and partial or total milling of rice; polishing and glazing of cereals and rice; bleaching of rice;
- (g) operations to colour or flavour sugar or form sugar lumps; partial or total milling of sugar in solid form;
- (h) peeling, stoning and shelling, of fruits, nuts and vegetables;
- (i) sharpening, simple grinding or simple cutting;
- (j) sifting, screening, sorting, classifying, grading, matching including the making-up of sets of articles;

---

<sup>2</sup> Preserving operations such as chilling, freezing or ventilating are considered insufficient within the meaning of point (a), whereas operations such as pickling, drying or smoking that are intended to give a product special or different characteristics are not considered insufficient.

- (k) simple placing in bottles, cans, flasks, bags, cases, boxes, fixing on cards or boards and all other simple packaging operations;
- (l) affixing or printing marks, labels, logos and other like distinguishing signs on products or their packaging;
- (m) simple mixing of products, whether or not of different kinds; mixing of sugar with any material;
- (n) simple addition of water or dilution with water or another substance that does not materially alter the characteristics of the product, or dehydration or denaturation of products;
- (o) simple assembly of parts of articles to constitute a complete article or disassembly of products into parts;
- (p) slaughter of animals.

2. For the purposes of paragraph 1, operations shall be considered simple if neither special skills nor machines, apparatus or equipment especially produced or installed are needed for carrying out those operations.

#### Article ORIG.8: Unit of qualification

1. For the purposes of this Chapter, the unit of qualification shall be the particular product which is considered as the basic unit when classifying the product under the Harmonised System.
2. For a consignment consisting of a number of identical products classified under the same heading of the Harmonised System, each individual product shall be taken into account when applying the provisions of this Chapter.

#### Article ORIG.9: Packing materials and containers for shipment

Packing materials and containers for shipment that are used to protect a product during transportation shall be disregarded in determining whether a product is originating.

#### Article ORIG.10: Packaging materials and containers for retail sale

Packaging materials and containers in which the product is packaged for retail sale, if classified with the product, shall be disregarded in determining the origin of the product, except for the purposes of calculating the value of non-originating materials if the product is subject to a maximum value of non-originating materials in accordance with ANNEX ORIG-2 [Product-specific rules of origin].

#### Article ORIG.11: Accessories, spare parts and tools

1. Accessories, spare parts, tools and instructional or other information materials shall be regarded as one product with the piece of equipment, machine, apparatus or vehicle in question if they:
  - (a) are classified and delivered with, but not invoiced separately from, the product; and
  - (b) are of the types, quantities and value which are customary for that product.



2. Accessories, spare parts, tools and instructional or other information materials referred to in paragraph 1 shall be disregarded in determining the origin of the product except for the purposes of calculating the value of non-originating materials if a product is subject to a maximum value of non-originating materials as set out in ANNEX ORIG-2 [Product-specific rules of origin].

#### Article ORIG.12: Sets

Sets, as defined in General Rule 3 for the Interpretation of the Harmonised System, shall be considered as originating in a Party if all of their components are originating. If a set is composed of originating and non-originating components, the set as a whole shall be considered as originating in a Party, if the value of the non-originating components does not exceed 15 % of the ex-works price of the set.

#### Article ORIG.13: Neutral elements

In order to determine whether a product is originating in a Party, it shall not be necessary to determine the origin of the following elements, which might be used in its production:

- (a) fuel, energy, catalysts and solvents;
- (b) plant, equipment, spare parts and materials used in the maintenance of equipment and buildings;
- (c) machines, tools, dies and moulds;
- (d) lubricants, greases, compounding materials and other materials used in production or used to operate equipment and buildings;
- (e) gloves, glasses, footwear, clothing, safety equipment and supplies;
- (f) equipment, devices and supplies used for testing or inspecting the product; and
- (g) other materials used in the production which are not incorporated into the product nor intended to be incorporated into the final composition of the product.

#### Article ORIG.14: Accounting segregation

1. Originating and non-originating fungible materials or "fungible products" shall be physically segregated during storage in order to maintain their originating and non-originating status.

2. For the purpose of paragraph 1, 'fungible materials' or "fungible products" means materials or products that are of the same kind and commercial quality, with the same technical and physical characteristics, and that cannot be distinguished from one another for origin purposes.

3. Notwithstanding paragraph 1, originating and non-originating fungible materials may be used in the production of a product without being physically segregated during storage if an accounting segregation method is used.

4. Notwithstanding paragraph 1, originating and non-originating fungible products classified in Chapter 10, 15, 27, 28, 29, heading 32.01 to 32.07, or heading 39.01 to 39.14 of the Harmonised System may be stored in a Party before exportation to the other Party without being physically segregated provided that an accounting segregation method is used.

5. The accounting segregation method referred to in paragraphs 3 and 4 shall be applied in conformity with a stock management method under accounting principles which are generally accepted in the Party.

6. The accounting segregation method shall be any method that ensures that at any time no more materials or products receive originating status than would be the case if the materials or products had been physically segregated.

7. A Party may require, under conditions set out in its laws or regulations, that the use of an accounting segregation method is subject to prior authorisation by the customs authorities of that Party. The customs authorities of the Party shall monitor the use of such authorisations and may withdraw an authorisation if the holder makes improper use of the accounting segregation method or fails to fulfil any of the other conditions laid down in this Chapter.

#### Article ORIG.15: Returned products

If a product originating in a Party exported from that Party to a third country returns to that Party, it shall be considered as a non-originating product unless it can be demonstrated to the satisfaction of the customs authority of that Party that the returning product:

- (a) is the same as that exported; and
- (b) has not undergone any operation other than what was necessary to preserve it in good condition while in that third country or while being exported.

#### Article ORIG.16: Non-alteration

1. An originating product declared for home use in the importing Party shall not, after exportation and prior to being declared for home use, have been altered, transformed in any way or subjected to operations other than to preserve it in good condition or than adding or affixing marks, labels, seals or any other documentation to ensure compliance with specific domestic requirements of the importing Party.

2. The storage or exhibition of a product may take place in a third country, provided that the product remains under customs supervision in that third country.

3. The splitting of consignments may take place in a third country if it is carried out by the exporter or under the responsibility of the exporter, provided that the consignments remain under customs supervision in that third country.

4. In the case of doubt as to whether the requirements provided for in paragraphs 1 to 3 are complied with, the customs authority of the importing Party may request the importer to provide evidence of compliance with those requirements, which may be given by any means, including contractual transport documents such as bills of lading or factual or concrete evidence based on the marking or numbering of packages or any evidence related to the product itself.

#### Article ORIG.17: Review of drawback of, or exemption from, customs duties

Not earlier than 2 years from the entry into force of this Agreement, at the request of either Party, the Trade Specialised Committee on Customs Cooperation and Rules of Origin shall review the Parties' respective duty drawback and inward-processing schemes. For this purpose, at the request of a Party, no later than 60 days from that request, the other Party shall provide the requesting Party

with available information and detailed statistics covering the period from the entry into force of this Agreement, or the previous 5 years if that is shorter, on the operation of its duty-drawback and inward-processing scheme. In the light of this review, the Trade Specialised Committee on Customs Cooperation and Rules of Origin may make recommendations to the Partnership Council for the amendment of the provisions of this Chapter and its Annexes, with a view to introducing limitations or restrictions with respect to drawback of or exemption from customs duties.

### *Section 2: Origin procedures*

#### Article ORIG.18: Claim for preferential tariff treatment

1. The importing Party, on importation, shall grant preferential tariff treatment to a product originating in the other Party within the meaning of this Chapter on the basis of a claim by the importer for preferential tariff treatment. The importer shall be responsible for the correctness of the claim for preferential tariff treatment and for compliance with the requirements provided for in this Chapter.

2. A claim for preferential tariff treatment shall be based on:

- (a) a statement on origin that the product is originating made out by the exporter; or
- (b) the importer's knowledge that the product is originating.

3. The importer making the claim for preferential tariff treatment based on a statement on origin as referred to in point (a) of paragraph 2 shall keep the statement on origin and, when required by the customs authority of the importing Party, shall provide a copy thereof to that customs authority.

#### Article ORIG.18a: Time of the claim for preferential tariff treatment

1. A claim for preferential tariff treatment and the basis for that claim as referred to in Article ORIG.18(2) [Claim for preferential tariff treatment] shall be included in the customs import declaration in accordance with the laws and regulations of the importing Party.

2. By way of derogation from paragraph 1 of this Article, if the importer did not make a claim for preferential tariff treatment at the time of importation, the importing Party shall grant preferential tariff treatment and repay or remit any excess customs duty paid provided that:

- (a) the claim for preferential tariff treatment is made no later than three years after the date of importation, or such longer time period as specified in the laws and regulations of the importing Party;
- (b) the importer provides the basis for the claim as referred to in Article ORIG.18(2) [Claim for preferential tariff treatment]; and
- (c) the product would have been considered originating and would have satisfied all other applicable requirements within the meaning of Section 1 [Rules of origin] of this Chapter if it had been claimed by the importer at the time of importation.

The other obligations applicable to the importer under Article ORIG.18 [Claim for preferential tariff treatment] remain unchanged.

#### Article ORIG.19: Statement on origin

1. A statement on origin shall be made out by an exporter of a product on the basis of information demonstrating that the product is originating, including information on the originating status of materials used in the production of the product. The exporter shall be responsible for the correctness of the statement on origin and the information provided.
2. A statement on origin shall be made out using one of the language versions set out in ANNEX ORIG-4 [Text of the statement on origin] in an invoice or on any other document that describes the originating product in sufficient detail to enable the identification of that product. The exporter shall be responsible for providing sufficient detail to allow the identification of the originating product. The importing Party shall not require the importer to submit a translation of the statement on origin.
3. A statement on origin shall be valid for 12 months from the date it was made out or for such longer period as provided by the Party of import up to a maximum of 24 months.
4. A statement on origin may apply to:
  - (a) a single shipment of one or more products imported into a Party; or
  - (b) multiple shipments of identical products imported into a Party within the period specified in the statement on origin, which shall not exceed 12 months.
5. If, at the request of the importer, unassembled or disassembled products within the meaning of General Rule 2(a) for the Interpretation of the Harmonised System that fall within Sections XV to XXI of the Harmonised System are imported by instalments, a single statement on origin for such products may be used in accordance with the requirements laid down by the customs authority of the importing Party.

#### Article ORIG.20: Discrepancies

The customs authority of the importing Party shall not reject a claim for preferential tariff treatment due to minor errors or discrepancies in the statement on origin, or for the sole reason that an invoice was issued in a third country.

#### Article ORIG.21: Importer's knowledge

1. For the purposes of a claim for preferential tariff treatment that is made under point (b) of Article ORIG.18(2) [Claim for preferential tariff treatment], the importer's knowledge that a product is originating in the exporting Party shall be based on information demonstrating that the product is originating and satisfies the requirements provided for in this Chapter.
2. Before claiming the preferential treatment, in the event that an importer is unable to obtain the information referred to in paragraph 1 of this Article as a result of the exporter deeming it to be confidential information or for any other reason, the exporter may provide a statement on origin so that the importer may claim the preferential tariff treatment on the basis of point (a) of Article ORIG.18(2) [Claim for Preferential Tariff Treatment].

#### Article ORIG.22: Record-keeping requirements

1. For a minimum of three years after the date of importation of the product, an importer making a claim for preferential tariff treatment for a product imported into the importing Party shall keep:
  - (a) if the claim was based on a statement on origin, the statement on origin made out by the exporter; or
  - (b) if the claim was based on the importer's knowledge, all records demonstrating that the product satisfies the requirements for obtaining originating status.
2. An exporter who has made out a statement on origin shall, for a minimum of four years after that statement on origin was made out, keep a copy of the statement on origin and all other records demonstrating that the product satisfies the requirements to obtain originating status.
3. The records to be kept in accordance with this Article may be held in electronic format.

#### Article ORIG.23: Small consignments

1. By way of derogation from Articles ORIG.18 [Claim for Preferential Tariff Treatment] to ORIG.21 [Importer's Knowledge], provided that the product has been declared as meeting the requirements of this Chapter and the customs authority of the importing Party has no doubts as to the veracity of that declaration, the importing Party shall grant preferential tariff treatment to:
  - (a) a product sent in a small package from private persons to private persons;
  - (b) a product forming part of a traveller's personal luggage; and
  - (c) for the United Kingdom, in addition to points (a) and (b), other low value consignments.
2. The following products are excluded from the application of paragraph 1 of this Article:
  - (a) products, the importation of which forms part of a series of importations that may reasonably be considered to have been made separately for the purpose of avoiding the requirements of Article ORIG.18 [Claim for Preferential Tariff Treatment];
  - (b) for the Union:
    - (i) a product imported by way of trade; the imports which are occasional and consist solely of products for the personal use of the recipients or travellers or their families are not be considered as imports by way of trade if it is evident from the nature and quantity of the products that no commercial purpose is intended; and
    - (ii) products, the total value of which exceeds EUR 500 in the case of products sent in small packages, or EUR 1 200 in the case of products forming part of a traveller's personal luggage. The amounts to be used in a given national currency shall be the equivalent in that currency of the amounts expressed in euro as at the first working day of October. The exchange rate amounts shall be those published for that day by the European Central Bank, unless a different amount is communicated to the European Commission by 15 October, and shall apply from 1 January the following year. The European Commission shall notify the United Kingdom of the relevant

amounts. The Union may establish other limits which it will communicate to the United Kingdom; and

- (c) for the United Kingdom, products whose total value exceeds the limits set under the domestic law of the United Kingdom. The United Kingdom will communicate these limits to the Union.

3. The importer shall be responsible for the correctness of the declaration and for the compliance with the requirements provided for in this Chapter. The record-keeping requirements set out in Article ORIG.22 [Record-keeping requirements] shall not apply to the importer under this Article.

#### Article ORIG.24: Verification

1. The customs authority of the importing Party may conduct a verification as to whether a product is originating or whether the other requirements of this Chapter are satisfied, on the basis of risk assessment methods, which may include random selection. Such verifications may be conducted by means of a request for information from the importer who made the claim referred to in Article ORIG.18 [Claim for Preferential Tariff Treatment], at the time the import declaration is submitted, before the release of the products, or after the release of the products.

2. The information requested pursuant to paragraph 1 shall cover no more than the following elements:

- (a) if the claim was based on a statement on origin, that statement on origin; and
- (b) information pertaining to the fulfilment of origin criteria, which is:
  - (i) where the origin criterion is “wholly obtained”, the applicable category (such as harvesting, mining, fishing) and the place of production;
  - (ii) where the origin criterion is based on change in tariff classification, a list of all the non-originating materials, including their tariff classification (in 2, 4 or 6-digit format, depending on the origin criterion);
  - (iii) where the origin criterion is based on a value method, the value of the final product as well as the value of all the non-originating materials used in the production of that product;
  - (iv) where the origin criterion is based on weight, the weight of the final product as well as the weight of the relevant non-originating materials used in the final product;
  - (v) where the origin criterion is based on a specific production process, a description of that specific process.

3. When providing the requested information, the importer may add any other information that it considers relevant for the purpose of verification.

4. If the claim for preferential tariff treatment is based on a statement on origin, the importer shall provide that statement on origin but may reply to the customs authority of the importing Party that the importer is not in a position to provide the information referred to in point (b) of paragraph 2.

5. If the claim for preferential tariff treatment is based on the importer's knowledge, after having first requested information in accordance with paragraph 1, the customs authority of the importing Party conducting the verification may request the importer to provide additional information if that customs authority considers that additional information is necessary in order to verify the originating status of the product or whether the other requirements of this Chapter are met. The customs authority of the importing Party may request the importer for specific documentation and information, if appropriate.

6. If the customs authority of the importing Party decides to suspend the granting of preferential tariff treatment to the product concerned while awaiting the results of the verification, the release of the products shall be offered to the importer subject to appropriate precautionary measures including guarantees. Any suspension of preferential tariff treatment shall be terminated as soon as possible after the customs authority of the importing Party has ascertained the originating status of the products concerned, or the fulfilment of the other requirements of this Chapter.

#### Article ORIG.25: Administrative cooperation

1. In order to ensure the proper application of this Chapter, the Parties shall cooperate, through the customs authority of each Party, in verifying whether a product is originating and is in compliance with the other requirements provided for in this Chapter.

2. If the claim for preferential tariff treatment was based on a statement on origin, as appropriate after having first requested information in accordance with Article ORIG.24(1) [Verification] and based on the reply from the importer, the customs authority of the importing Party conducting the verification may also request information from the customs authority of the exporting Party within a period of two years after the importation of the products, or from the moment the claim is made pursuant to point (a) of Article ORIG.18a(2) [Time of the claim for preferential treatment], if the customs authority of the importing Party conducting the verification considers that additional information is necessary in order to verify the originating status of the product or to verify that the other requirements provided for in this Chapter have been met. The request for information shall include the following elements:

- (a) the statement on origin;
- (b) the identity of the customs authority issuing the request;
- (c) the name of the exporter;
- (d) the subject and scope of the verification; and
- (e) any relevant documentation.

In addition, the customs authority of the importing Party may request the customs authority of the exporting Party to provide specific documentation and information, where appropriate.

3. The customs authority of the exporting Party may, in accordance with its laws and regulations, request documentation or examination by calling for any evidence, or by visiting the premises of the exporter, to review records and observe the facilities used in the production of the product.

4. Without prejudice to paragraph 5, the customs authority of the exporting Party receiving the request referred to in paragraph 2 shall provide the customs authority of the importing Party with the following information:

- (a) the requested documentation, where available;
- (b) an opinion on the originating status of the product;
- (c) the description of the product that is subject to examination and the tariff classification relevant to the application of this Chapter;
- (d) a description and explanation of the production process that is sufficient to support the originating status of the product;
- (e) information on the manner in which the examination of the product was conducted; and
- (f) supporting documentation, where appropriate.

5. The customs authority of the exporting Party shall not provide the information referred to in points (a), (d) and (f) of paragraph 4 to the customs authority of the importing Party if that information is deemed confidential by the exporter.

6. Each Party shall notify the other Party of the contact details of the customs authorities and shall notify the other Party of any change to those contact details within 30 days after the date of the change.

#### Article ORIG.26: Denial of preferential tariff treatment

1. Without prejudice to paragraph 3, the customs authority of the importing Party may deny preferential tariff treatment, if:

- (a) within three months after the date of a request for information pursuant to Article ORIG.24(1) [Verification]:
  - (i) no reply has been provided by the importer;
  - (ii) where the claim for preferential tariff treatment was based on a statement on origin, no statement on origin has been provided; or
  - (iii) where the claim for preferential tariff treatment was based on the importer's knowledge, the information provided by the importer is inadequate to confirm that the product is originating;
- (b) within three months after the date of a request for additional information pursuant to Article ORIG.24(5) [Verification]:
  - (i) no reply has been provided by the importer; or
  - (ii) the information provided by the importer is inadequate to confirm that the product is originating;



(c) within 10 months<sup>3</sup> after the date of a request for information pursuant to Article ORIG.25(2) [Administrative Cooperation]:

(i) no reply has been provided by the customs authority of the exporting Party; or

(ii) the information provided by the customs authority of the exporting Party is inadequate to confirm that the product is originating.

2. The customs authority of the importing Party may deny preferential tariff treatment to a product for which an importer claims preferential tariff treatment where the importer fails to comply with requirements under this Chapter other than those relating to the originating status of the products.

3. If the customs authority of the importing Party has sufficient justification to deny preferential tariff treatment under paragraph 1 of this Article, in cases where the customs authority of the exporting Party has provided an opinion pursuant to point (b) of Article ORIG.25(4) [Administrative cooperation] confirming the originating status of the products, the customs authority of the importing Party shall notify the customs authority of the exporting Party of its intention to deny the preferential tariff treatment within two months after the date of receipt of that opinion.

If such notification is made, consultations shall be held at the request of either Party, within three months after the date of the notification. The period for consultation may be extended on a case-by-case basis by mutual agreement between the customs authorities of the Parties. The consultation may take place in accordance with the procedure set by the Trade Specialised Committee on Customs Cooperation and Rules of Origin.

Upon the expiry of the period for consultation, if the customs authority of the importing Party cannot confirm that the product is originating, it may deny the preferential tariff treatment if it has a sufficient justification for doing so and after having granted the importer the right to be heard. However, when the customs authority of the exporting Party confirms the originating status of the products and provides justification for such conclusion, the customs authority of the importing Party shall not deny preferential tariff treatment to a product on the sole ground that Article ORIG.25(5) [Administrative cooperation] has been applied.

4. In all cases, the settlement of differences between the importer and the customs authority of the Party of import shall be under the law of the Party of import.

#### Article ORIG.27: Confidentiality

1. Each Party shall maintain, in accordance with its laws and regulations, the confidentiality of any information provided to it by the other Party, pursuant to this Chapter, and shall protect that information from disclosure.

2. Where, notwithstanding Article ORIG.25(5) [Administrative cooperation], confidential business information has been obtained from the exporter by the customs authority of the exporting

---

<sup>3</sup> The period will be of 12 months for requests of information pursuant to Article ORIG.25(2) [Administrative cooperation] addressed to the customs authority of the exporting Party during the first three months of the application of this Agreement.

Party or importing Party through the application of Articles ORIG.24 [Verification] and ORIG.25 [Administrative cooperation], that information shall not be disclosed.

3. Each Party shall ensure that confidential information collected pursuant to this Chapter shall not be used for purposes other than the administration and enforcement of decisions and determinations relating to origin and to customs matters, except with the permission of the person or Party who provided the confidential information.

4. Notwithstanding paragraph 3, a Party may allow information collected pursuant to this Chapter to be used in any administrative, judicial, or quasi-judicial proceedings instituted for failure to comply with customs-related laws implementing this Chapter. A Party shall notify the person or Party who provided the information in advance of such use.

#### Article ORIG.28: Administrative measures and sanctions

Each Party shall ensure the effective enforcement of this Chapter. Each Party shall ensure that the competent authorities are able to impose administrative measures, and, where appropriate, sanctions, in accordance with its laws and regulations, on any person who draws up a document, or causes a document to be drawn up, which contains incorrect information that was provided for the purpose of obtaining a preferential tariff treatment for a product, who does not comply with the requirements set out in Article ORIG.22 [Record-keeping requirements], or who does not provide the evidence, or refuses to submit to a visit, as referred to in Article ORIG.25(3) [Administrative cooperation].

#### *Section 3: Other Provisions*

#### Article ORIG.29: Ceuta and Melilla

1. For purposes of this Chapter, in the case of the Union, the term “Party” does not include Ceuta and Melilla.

2. Products originating in the United Kingdom, when imported into Ceuta and Melilla, shall in all respects be subject to the same customs treatment under this Agreement, as that which is applied to products originating in the customs territory of the Union under Protocol 2 of the Act of Accession of the Kingdom of Spain and the Portuguese Republic to the European Union. The United Kingdom shall grant to imports of products covered by this Agreement and originating in Ceuta and Melilla the same customs treatment as that which is granted to products imported from and originating in the Union.

3. The rules of origin and origin procedures referred to in this Chapter apply *mutatis mutandis* to products exported from the United Kingdom to Ceuta and Melilla and to products exported from Ceuta and Melilla to the United Kingdom.

4. Ceuta and Melilla shall be considered as a single territory.

5. Article ORIG.4 [Cumulation of origin] applies to import and exports of products between the Union, the United Kingdom and Ceuta and Melilla.

6. The exporters shall enter “the United Kingdom” or “Ceuta and Melilla” in field 3 of the text of the statement on origin, depending on the origin of the product.

7. The customs authority of the Kingdom of Spain shall be responsible for the application and implementation of this Chapter in Ceuta and Melilla.

#### Article ORIG.30: Transitional provisions for products in transit or storage

The provisions of this Agreement may be applied to products which comply with the provisions of this Chapter and which on the date of entry into force of this Agreement are either in transit from the exporting Party to the importing Party or under customs control in the importing Party without payment of import duties and taxes, subject to the making of a claim for preferential tariff treatment referred to in Article ORIG.18 [Claim for preferential tariff treatment] to the customs authority of the importing Party, within 12 months of that date.

#### Article ORIG.31: Amendment to this chapter and its annexes

The Partnership Council may amend this Chapter and its Annexes.

### Chapter 3: Sanitary and phytosanitary measures

#### Article SPS.1: Objectives

The objectives of this Chapter are to:

- (a) protect human, animal and plant life or health in the territories of the Parties while facilitating trade between the Parties;
- (b) further the implementation of the SPS Agreement;
- (c) ensure that the Parties' sanitary and phytosanitary ("SPS") measures do not create unnecessary barriers to trade;
- (d) promote greater transparency and understanding on the application of each Party's SPS measures;
- (e) enhance cooperation between the Parties in the fight against antimicrobial resistance, promotion of sustainable food systems, protection of animal welfare, and on electronic certification;
- (f) enhance cooperation in the relevant international organisations to develop international standards, guidelines and recommendations on animal health, food safety and plant health; and
- (g) promote implementation by each Party of international standards, guidelines and recommendations.

#### Article SPS.2: Scope

1. This Chapter applies to all SPS measures of a Party that may, directly or indirectly, affect trade between the Parties.

2. This Chapter also lays down separate provisions regarding cooperation on animal welfare, antimicrobial resistance and sustainable food systems.

### Article SPS.3: Definitions

1. For the purposes of this Chapter, the following definitions apply:
  - (a) the definitions contained in Annex A of the SPS Agreement;
  - (b) the definitions adopted under the auspices of the Codex Alimentarius Commission (the "Codex");
  - (c) the definitions adopted under the auspices of the World Organisation for Animal Health (the "OIE"); and
  - (d) the definitions adopted under the auspices of the International Plant Protection Convention (the "IPPC").
2. For the purposes of this Chapter:
  - (a) "import conditions" means any SPS measures that are required to be fulfilled for the import of products; and
  - (b) "protected zone" for a specified regulated plant pest means an officially defined geographical area in which that pest is not established in spite of favourable conditions and its presence in other parts of the territory of the Party, and into which that pest is not allowed to be introduced.
3. The Trade Specialised Committee on Sanitary and Phytosanitary Measures may adopt other definitions for the purposes of this Chapter, taking into consideration the glossaries and definitions of the relevant international organisations, such as the Codex, OIE and IPPC.
4. The definitions under the SPS Agreement prevail to the extent that there is an inconsistency between the definitions adopted by the Trade Specialised Committee on Sanitary and Phytosanitary Measures or adopted under the auspices of the Codex, the OIE, the IPPC and the definitions under the SPS Agreement. In the event of an inconsistency between definitions adopted by the Trade Specialised Committee on Sanitary and Phytosanitary Measures and the definitions set out in the Codex, OIE or IPPC, the definitions set out in the Codex, OIE or IPPC shall prevail.

### Article SPS.4: Rights and obligations

The Parties reaffirm their rights and obligations under the SPS Agreement. This includes the right to adopt measures in accordance with Article 5(7) of the SPS Agreement.

### Article SPS.5: General principles

1. The Parties shall apply SPS measures for achieving their appropriate level of protection that are based on risk assessments in accordance with relevant provisions, including Article 5 of the SPS Agreement.
2. The Parties shall not use SPS measures to create unjustified barriers to trade.
3. Regarding trade-related SPS procedures and approvals established under this Chapter, each Party shall ensure that these procedures and related SPS measures:

- (a) are initiated and completed without undue delay;
- (b) do not include unnecessary, scientifically and technically unjustified or unduly burdensome information requests that might delay access to each other's markets;
- (c) are not applied in a manner which would constitute arbitrary or unjustifiable discrimination against the other Party's entire territory or parts of the other Party's territory where identical or similar SPS conditions exist; and
- (d) are proportionate to the risks identified and not more trade restrictive than necessary to achieve the importing Party's appropriate level of protection.

4. The Parties shall not use the procedures referred to in paragraph 3, or any requests for additional information, to delay access to their markets without scientific and technical justification.

5. Each Party shall ensure that any administrative procedure it requires concerning the import conditions on food safety, animal health or plant health is not more burdensome or trade restrictive than necessary to give the importing Party adequate confidence that these conditions are met. Each Party shall ensure that the negative effects on trade of any administrative procedures are kept to a minimum and that the clearance processes remain simple and expeditious while meeting the importing Party's conditions.

6. The importing Party shall not put in place any additional administrative system or procedure that unnecessarily hampers trade.

#### Article SPS.6: Official certification

1. Where the importing Party requires official certificates, the model certificates shall be:
  - (a) set in line with the principles as laid down in the international standards of the Codex, the IPPC and the OIE; and
  - (b) applicable to imports from all parts of the territory of the exporting Party.
2. The Trade Specialised Committee on Sanitary and Phytosanitary Measures may agree on specific cases where the model certificates referred to in paragraph 1 would be established only for a part or parts of the territory of the exporting Party. The Parties shall promote the implementation of electronic certification and other technologies to facilitate trade.

#### Article SPS.7: Import conditions and procedures

1. Without prejudice to the rights and obligations each Party has under the SPS Agreement and this Chapter, the import conditions of the importing Party shall apply to the entire territory of the exporting Party in a consistent manner.
2. The exporting Party shall ensure that products exported to the other Party, such as animals and animal products, plants and plant products, or other related objects, meet the SPS requirements of the importing Party.
3. The importing Party may require that imports of particular products are subject to authorisation. Such authorisation shall be granted where a request is made by the relevant competent authority of the exporting Party which objectively demonstrates, to the satisfaction of the importing Party, that the authorisation requirements of the importing Party are fulfilled. The

relevant competent authority of the exporting Party may make a request for authorisation in respect of the entire territory of the exporting Party. The importing Party shall grant such requests on that basis, where they fulfil the authorisation requirements of the importing Party as set out in this paragraph.

4. The importing Party shall not introduce authorisation requirements which are additional to those which apply at the end of the transition period, unless the application of such requirements to further products is justified to mitigate a significant risk to human, animal or plant health.

5. The importing Party shall establish and communicate to the other Party import conditions for all products. The importing Party shall ensure that its import conditions are applied in a proportionate and non-discriminatory manner.

6. Without prejudice to provisional measures under Article 5(7) of the SPS Agreement, for products, or other related objects, where a phytosanitary concern exists, the import conditions shall be restricted to measures to protect against regulated pests of the importing Party and shall be applicable to the entire territory of the exporting Party.

7. Notwithstanding paragraphs 1 and 3, in the case of import authorisation requests for a specific product, where the exporting Party has requested to be examined only for a part, or certain parts, of its territory (in the case of the Union, individual Member States), the importing Party shall promptly proceed to the examination of that request. Where the importing Party receives requests in respect of the specific product from more than one part of the exporting Party, or, where further requests are received in respect of a product which has already been authorised, the importing Party shall expedite completion of the authorisation procedure, taking into account the identical or similar SPS regime applicable in the different parts of the exporting Party.

8. Each Party shall ensure that all SPS control, inspection and approval procedures are initiated and completed without undue delay. Information requirements shall be limited to what is necessary for the approval process to take into account information already available in the importing Party, such as on the legislative framework and audit reports of the exporting Party.

9. Except in duly justified circumstances related to its level of protection, each Party shall provide a transition period between the publication of any changes to its approval procedures and their application to allow the other Party to become familiar with and adapt to such changes. Each Party shall not unduly prolong the approval process for applications submitted prior to publication of the changes.

10. In relation to the processes set out in paragraphs 3 to 8, the following actions shall be taken:

(a) as soon as the importing Party has positively concluded its assessment, it shall promptly take all necessary legislative and administrative measures to allow trade to take place without undue delay;

(b) the exporting Party shall:

(i) provide all relevant information required by the importing Party; and

(ii) give reasonable access to the importing Party for audit and other relevant procedures.

(c) the importing party shall establish a list of regulated pests for products, or other related objects, where a phytosanitary concern exists. That list shall contain:

- (i) the pests not known to occur within any part of its own territory;
- (ii) the pests known to occur within its own territory and under official control;
- (iii) the pests known to occur within parts of its own territory and for which pest free areas or protected zones are established; and
- (iv) non-quarantine pests known to occur within its own territory and under official control for specified planting material.

11. The importing Party shall accept consignments without requiring that the importing Party verifies compliance of those consignments before their departure from the territory of the exporting Party.

12. A Party may collect fees for the costs incurred to conduct specific SPS frontier checks, which should not exceed the recovery of the costs.

13. The importing Party shall have the right to carry out import checks on products imported from the exporting Party for the purposes of ensuring compliance with its SPS import requirements.

14. The import checks carried out on products imported from the exporting Party shall be based on the SPS risk associated with such importations. Import checks shall be carried out only to the extent necessary to protect human, animal or plant life and health, without undue delay and with a minimum effect on trade between the Parties.

15. Information on the proportion of products from the exporting Party checked at import shall be made available by the importing Party upon request of the exporting Party.

16. If import checks reveal non-compliance with the relevant import conditions the action taken by the importing Party must be based on an assessment of the risk involved and not be more trade restrictive than required to achieve the Party's appropriate level of SPS protection.

#### Article SPS.8 Lists of approved establishments

1. Whenever justified, the importing Party may maintain a list of approved establishments meeting its import requirements as a condition to allow imports of animal products from these establishments.

2. Unless justified to mitigate a significant risk to human or animal health, lists of approved establishments shall only be required for the products for which they were required at the end of the transition period.

3. The exporting Party shall inform the importing Party of its list of establishments meeting the importing Party's conditions which shall be based on guarantees provided by the exporting Party.

4. Upon a request from the exporting Party, the importing Party shall approve establishments which are situated in the territory of the exporting Party, based on guarantees provided by the exporting Party, without prior inspection of individual establishments.

5. Unless the importing Party requests additional information and subject to guarantees being provided by the exporting party, the importing Party shall take the necessary legislative or

administrative measures, in accordance with its applicable legal procedures, to allow imports from those establishments without undue delay.

6. The list of the approved establishments shall be made publicly available by the importing Party.

7. Where the importing Party decides to reject the request of the exporting Party to accept adding an establishment to the list of approved establishments, it shall inform the exporting Party without delay and shall submit a reply, including information about the non-conformities which led to the rejection of the establishment's approval.

#### Article SPS.9: Transparency and exchange of information

1. Each Party shall pursue transparency as regards SPS measures applicable to trade and shall for those purposes undertake the following actions:

- (a) promptly communicate to the other Party any changes to its SPS measures and approval procedures, including changes that may affect its capacity to fulfil the SPS import requirements of the other Party for certain products;
- (b) enhance mutual understanding of its SPS measures and their application;
- (c) exchange information with the other Party on matters related to the development and application of SPS measures, including the progress on new available scientific evidence, that affect, or may affect, trade between the Parties with a view to minimising negative trade effects;
- (d) upon request of the other Party, communicate the conditions that apply for the import of specific products within 20 working days;
- (e) upon request of the other Party, communicate the state of play of the procedure for the authorisation of specific products within 20 working days;
- (f) communicate to the other Party any significant change to the structure or organisation of a Party's competent authority;
- (g) on request, communicate the results of a Party's official control and a report that concerns the results of the control carried out;
- (h) on request, communicate the results of an import check provided for in case of a rejected or a non-compliant consignment; and
- (i) on request, communicate, without undue delay, a risk assessment or scientific opinion produced by a Party that is relevant to this Chapter.

2. Where a Party has made available the information in paragraph 1 via notification to the WTO's Central Registry of Notifications or to the relevant international standard-setting body, in accordance with its relevant rules, the requirements in paragraph 1, as they apply to that information, are fulfilled.



## Article SPS.10: Adaptation to regional conditions

1. The Parties shall recognise the concept of zoning including disease or pest-free areas, protected zones and areas of low disease or pest prevalence and shall apply it to the trade between the Parties, in accordance with the SPS Agreement, including the guidelines to further the practical implementation of Article 6 of the SPS Agreement (WTO/SPS Committee Decision G/SPS/48) and the relevant recommendations, standards and guidelines of the OIE and IPPC. The Trade Specialised Committee on Sanitary and Phytosanitary Measures may define further details for these procedures, taking into account any relevant SPS Agreement, OIE and IPPC standards, guidelines or recommendations.
2. The Parties may also agree to cooperate on the concept of compartmentalisation as referred to in Chapters 4.4 and 4.5 of the OIE Terrestrial Animal Health Code and Chapters 4.1 and 4.2 of the OIE Aquatic Animal Health Code.
3. When establishing or maintaining the zones referred to in paragraph 1, the Parties shall consider factors such as geographical location, ecosystems, epidemiological surveillance and the effectiveness of SPS controls.
4. With regard to animals and animal products, when establishing or maintaining import conditions upon the request of the exporting Party, the importing Party shall recognise the disease-free areas established by the exporting Party as a basis for consideration towards the determination of allowing or maintaining the import, without prejudice to paragraphs 8 and 9.
5. The exporting Party shall identify the parts of its territory referred to in paragraph 4 and, if requested, provide a full explanation and supporting data based on the OIE standards, or in other ways established by the Trade Specialised Committee on Sanitary and Phytosanitary Measures, based on the knowledge acquired through experience of the exporting Party's relevant authorities.
6. With regard to plants, plant products, and other related objects, when establishing or maintaining phytosanitary import conditions, on request of the exporting Party, the importing Party shall recognise the pest-free areas, pest-free places of production, pest-free production sites, areas of low pest prevalence and protected zones established by the exporting Party as a basis for consideration towards the determination to allow or maintain the import, without prejudice to paragraphs 8 and 9.
7. The exporting Party shall identify its pest-free areas, pest-free places of production, pest-free production sites and areas of low pest prevalence or protected zones. If requested by the importing Party, the exporting Party shall provide a full explanation and supporting data based on the International Standards for Phytosanitary Measures developed under the IPPC, or in other ways established by the Trade Specialised Committee on Sanitary and Phytosanitary Measures, based on the knowledge acquired through experience of the exporting Party's relevant phytosanitary authorities.
8. The Parties shall recognise disease-free areas and protected zones which are in place at the end of the transition period.
9. Paragraph 8 shall also apply to subsequent adaptations to the disease-free areas and protected zones (in the case of the United Kingdom pest-free areas), except in cases of significant changes in the disease or pest situations.

10. The Parties may carry out audits and verifications pursuant to Article 11 to implement paragraphs 4 to 9 of this Article.

11. The Parties shall establish close cooperation with the objective of maintaining confidence in the procedures in relation to the establishment of disease- or pest-free areas, pest-free places of production, pest-free production sites and areas of low pest or disease prevalence and protected zones, with the aim to minimise trade disruption.

12. The importing Party shall base its own determination of the animal or plant health status of the exporting Party or parts thereof on the information provided by the exporting Party in accordance with the SPS Agreement, OIE and IPPC standards, and take into consideration any determination made by the exporting Party.

13. Where the importing Party does not accept the determination made by the exporting Party as referred to in paragraph 12 of this Article, the importing Party shall objectively justify and explain to the exporting Party the reasons for that rejection and, upon request, hold consultations, in accordance with Article SPS 12(2).

14. Each Party shall ensure that the obligations set out in paragraphs 4 to 9, 12 and 13 are carried out without undue delay. The importing Party will expedite the recognition of the disease or pest status when the status has been recovered after an outbreak.

15. Where a Party considers that a specific region has a special status with respect to a specific disease and which fulfils the criteria laid down in the OIE Terrestrial Animal Health Code Chapter 1.2 or the OIE Aquatic Animal Health Code Chapter 1.2, it may request recognition of this status. The importing Party may request additional guarantees in respect of imports of live animals and animal products appropriate to the agreed status.

#### Article SPS.11: Audits and verifications

1. The importing Party may carry out audits and verifications of the following:

- (a) all or part of the other Party's authorities' inspection and certification system;
- (b) the results of the controls carried out under the exporting Party's inspection and certification system.

2. The Parties shall carry out those audits and verifications in accordance with the provisions of the SPS Agreement, taking into account the relevant international standards, guidelines and recommendations of the Codex Alimentarius, OIE or IPPC.

3. For the purposes of carrying out such audits and verifications, the importing Party may conduct audits and verifications by means of requests of information from the exporting Party or audit and verification visits to the exporting Party, which may include:

- (a) an assessment of all or part of the responsible authorities' total control programme, including, where appropriate, reviews of regulatory audit and inspection activities;
- (b) on-the-spot checks; and
- (c) the collection of information and data to assess the causes of recurring or emerging problems in relation to exports of products.

4. The importing Party shall share with the exporting Party the results and conclusions of the audits and verifications carried out pursuant to paragraph 1. The importing Party may make these results publicly available.

5. Prior to the commencement of an audit or verification, the Parties shall discuss the objectives and scope of the audit or verification, the criteria or requirements against which the exporting Party will be assessed, and the itinerary and procedures for conducting the audit or verification which shall be laid down in an audit or verification plan. Unless otherwise agreed by the Parties, the importing Party shall provide the exporting Party with an audit or verification plan at least 30 days prior to the commencement of the audit or verification.

6. The importing Party shall provide the exporting Party the opportunity to comment on the draft audit or verification report. The importing Party shall provide a final report in writing to the exporting Party normally within two months from the date of receipt of those comments.

7. Each Party shall bear its own costs associated with such an audit or verification.

#### Article SPS.12: Notification and consultation

1. A Party shall notify the other Party without undue delay of:

(a) a significant change to pest or disease status;

(b) the emergence of a new animal disease;

(c) a finding of epidemiological importance with respect to an animal disease;

(d) a significant food safety issue identified by a Party;

(e) any additional measures beyond the basic requirements of their respective SPS measures taken to control or eradicate animal disease or protect human health, and any changes in preventive policies, including vaccination policies;

(f) on request, the results of a Party's official control and a report that concerns the results of the control carried out; and

(g) any significant changes to the functions of a system or database.

2. If a Party has a significant concern with respect to food safety, plant health, or animal health, or an SPS measure that the other Party has proposed or implemented, that Party may request technical consultations with the other Party. The requested Party should respond to the request without undue delay. Each Party shall endeavour to provide the information necessary to avoid a disruption to trade and, as the case may be, to reach a mutually acceptable solution.

3. Consultations referred to in paragraph 2 may be held via telephone conference, videoconference, or any other means of communication mutually agreed on by the Parties.

#### Article SPS.13: Emergency measures

1. If the importing Party considers that there is a serious risk to human, animal or plant life and health, it may take without prior notification the necessary measures for the protection of human, animal or plant life and health. For consignments that are in transit between the Parties, the

importing Party shall consider the most suitable and proportionate solution to avoid unnecessary disruptions to trade.

2. The Party taking the measures shall notify the other Party of an emergency SPS measure as soon as possible after its decision to implement the measure and no later than 24 hours after the decision has been taken. If a Party requests technical consultations to address the emergency SPS measure, the technical consultations must be held within 10 days of the notification of the emergency SPS measure. The Parties shall consider any information provided through the technical consultations. These consultations shall be carried out in order to avoid unnecessary disruptions to trade. The Parties may consider options for the facilitation of the implementation or the replacement of the measures.

3. The importing Party shall consider, in a timely manner, information that was provided by the exporting Party when it makes its decision with respect to consignments that, at the time of adoption of the emergency SPS measure, are being transported between the Parties, in order to avoid unnecessary disruptions to trade.

4. The importing Party shall ensure that any emergency measure taken on the grounds referred to in paragraph 1 of this Article is not maintained without scientific evidence or, in cases where scientific evidence is insufficient, is adopted in accordance with Article 5(7) of the SPS Agreement.

#### Article: SPS.14: Multilateral international fora

The Parties agree to cooperate in multilateral international fora on the development of international standards, guidelines and recommendations in the areas under the scope of this Chapter.

#### Article SPS.15: Implementation and competent authorities

1. For the purposes of the implementation of this Chapter, each Party shall take all of the following into account:

- (a) decisions of the WTO SPS Committee;
- (b) the work of the relevant international standard setting bodies;
- (c) any knowledge and past experience it has of trading with the exporting Party; and
- (d) information provided by the other Party.

2. The Parties shall, without delay, provide each other with a description of the competent authorities of the Parties for the implementation of this Chapter. The Parties shall notify each other of any significant change to these competent authorities.

3. Each Party shall ensure that its competent authorities have the necessary resources to effectively implement this Chapter.

#### Article SPS.16: Cooperation on animal welfare

1. The Parties recognise that animals are sentient beings. They also recognise the connection between improved welfare of animals and sustainable food production systems.

2. The Parties undertake to cooperate in international fora to promote the development of the best possible animal welfare practices and their implementation. In particular, the Parties shall cooperate to reinforce and broaden the scope of the OIE animal welfare standards, as well as their implementation, with a focus on farmed animals.

3. The Parties shall exchange information, expertise and experiences in the field of animal welfare, particularly related to breeding, holding, handling, transportation and slaughter of food-producing animals.

4. The Parties shall strengthen their cooperation on research in the area of animal welfare in relation to animal breeding and the treatment of animals on farms, during transport and at slaughter.

#### Article SPS.17: Cooperation on antimicrobial resistance

1. The Parties shall provide a framework for dialogue and cooperation with a view to strengthening the fight against the development of anti-microbial resistance.

2. The Parties recognise that anti-microbial resistance is a serious threat to human and animal health. Misuse of anti-microbials in animal production, including non-therapeutic use, can contribute to anti-microbial resistance that may represent a risk to human life. The Parties recognise that the nature of the threat requires a transnational and One Health approach.

3. With a view to combating antimicrobial resistance, the Parties shall endeavour to cooperate internationally with regional or multilateral work programmes to reduce the unnecessary use of antibiotics in animal production and to work towards the cessation of the use of antibiotics as growth promoters internationally to combat antimicrobial resistance in line with the One Health approach, and in compliance with the Global Action Plan.

4. The Parties shall collaborate in the development of international guidelines, standards, recommendations and actions in relevant international organisations aiming to promote the prudent and responsible use of antibiotics in animal husbandry and veterinary practices.

5. The dialogue referred to in paragraph 1 shall cover, *inter alia*:

- (a) collaboration to follow up existing and future guidelines, standards, recommendations and actions developed in relevant international organisations and existing and future initiatives and national plans aiming to promote the prudent and responsible use of antibiotics and relating to animal production and veterinary practices;
- (b) collaboration in the implementation of the recommendations of OIE, WHO and Codex, in particular CAC-RCP61/2005;
- (c) the exchange of information on good farming practices;
- (d) the promotion of research, innovation and development;
- (e) the promotion of multidisciplinary approaches to combat antimicrobial resistance, including the One Health approach of the WHO, OIE and Codex Alimentarius.

#### Article SPS.18: Sustainable food systems

Each Party shall encourage its food safety, animal and plant health services to cooperate with their counterparts in the other Party with the aim of promoting sustainable food production methods and food systems.

#### Article SPS.19: Trade Specialised Committee on Sanitary and Phytosanitary Measures

The Trade Specialised Committee on Sanitary and Phytosanitary Measures shall supervise the implementation and operation of this Chapter and have the following functions:

- (a) promptly clarifying and addressing, where possible, any issue raised by a Party relating to the development, adoption or application of sanitary and phytosanitary requirements, standards and recommendations under this Chapter or the SPS Agreement;
- (b) discussing ongoing processes on the development of new regulations;
- (c) discussing as expeditiously as possible concerns expressed by a Party with regard to the SPS import conditions and procedures applied by the other Party;
- (d) regularly reviewing the Parties' SPS measures, including certification requirements and border clearance processes, and their application, in order to facilitate trade between the Parties, in accordance with the principles, objectives and procedures set out in Article 5 of the SPS Agreement. Each Party shall identify any appropriate action it will take, including in relation to the frequency of identity and physical checks, taking into consideration the results of this review and based on the criteria laid down in ANNEX SPS-1: Criteria referred to in Article SPS.19.(d).
- (e) exchanging views, information, and experiences with respect to the cooperation activities on protecting animal welfare and the fight against antimicrobial resistance carried out under SPS. 16 and 17;
- (f) on request of a Party, considering what constitutes a significant change in the disease or pest situation referred to in Article SPS 10(9);
- (g) adopting decisions to:
  - (i) add definitions as referred to in Article SPS 3(3);
  - (ii) define the specific cases referred to in Article SPS 6(2);
  - (iii) define details for the procedures referred to in Article SPS 10(1);
  - (iv) establish other ways to support the explanations referred to in Article SPS 10(5) and (7).

#### Chapter 4: Technical barriers to trade

#### Article TBT.1: Objective

The objective of this Chapter is to facilitate trade in goods between the Parties by preventing, identifying and eliminating unnecessary technical barriers to trade.

#### Article TBT.2: Scope

1. This Chapter applies to the preparation, adoption and application of all standards, technical regulations and conformity assessment procedures, which may affect trade in goods between the Parties.
2. This Chapter does not apply to:
  - (a) purchasing specifications prepared by governmental bodies for production or consumption requirements of such bodies; or
  - (b) SPS measures that fall within scope of Chapter 3 [Sanitary and phytosanitary measures].
3. The Annexes to this Chapter apply, in respect of products within their scope, in addition to this Chapter. Any provision in an Annex to this Chapter that an international standard or body or organisation is to be considered or recognised as relevant, does not prevent a standard developed by any other body or organisation from being considered to be a relevant international standard pursuant to Article TBT.4 (4) and (5).

#### Article TBT.3: Relationship with the TBT Agreement

1. Articles 2 to 9 of and Annexes 1 and 3 to the TBT Agreement are incorporated into and made part of this Agreement *mutatis mutandis*.
2. Terms referred to in this Chapter and in the Annexes to this Chapter shall have the same meaning as they have in the TBT Agreement.

#### Article TBT.4: Technical regulations

1. Each Party shall carry out impact assessments of planned technical regulations in accordance with its respective rules and procedures. The rules and procedures referred to in this paragraph and in paragraph 8 may provide for exceptions.
2. Each Party shall assess the available regulatory and non-regulatory alternatives to the proposed technical regulation that may fulfil the Party's legitimate objectives, in accordance with Article 2.2 of the TBT Agreement.
3. Each Party shall use relevant international standards as a basis for its technical regulations except when it can demonstrate that such international standards would be an ineffective or inappropriate means for the fulfilment of the legitimate objectives pursued.
4. International standards developed by the International Organization for Standardization (ISO), International Electrotechnical Commission (IEC), International Telecommunication Union (ITU) and Codex Alimentarius Commission (Codex) shall be the relevant international standards within the meaning of Article 2, Article 5 and Annex 3 of the TBT Agreement.

5. A standard developed by other international organisations, could also be considered a relevant international standard within the meaning of Article 2, Article 5 and Annex 3 of the TBT Agreement, provided that:

- (a) it has been developed by a standardising body which seeks to establish consensus either:
  - (i) among national delegations of the participating WTO Members representing all the national standardising bodies in their territory that have adopted, or expect to adopt, standards for the subject matter to which the international standardisation activity relates, or,
  - (ii) among governmental bodies of participating WTO Members, and,
- (b) it has been developed in accordance with the Decision of the WTO Committee on Technical Barriers to Trade on Principles for the Development of International Standards, Guides and Recommendations with relation to Articles 2, 5, and Annex 3 of the TBT Agreement.<sup>4</sup>

6. Where a Party does not use international standards as a basis for a technical regulation, on request of the other Party, it shall identify any substantial deviation from the relevant international standard, explain the reasons why such standards were judged inappropriate or ineffective for the objective pursued, and provide the scientific or technical evidence on which that assessment was based.

7. Each Party shall review its technical regulations to increase the convergence of those technical regulations with relevant international standards, taking into account, *inter alia*, any new developments in the relevant international standards or any changes in the circumstances that have given rise to divergence from any relevant international standards.

8. In accordance with its respective rules and procedures and without prejudice to Title X [Good Regulatory Practices and Regulatory Cooperation], when developing a major technical regulation which may have a significant effect on trade, each Party shall ensure that procedures exist that allow persons to express their opinion in a public consultation, except where urgent problems of safety, health, environment or national security arise or threaten to arise. Each Party shall allow persons of the other Party to participate in such consultations on terms that are no less favourable than those accorded to its own nationals, and shall make the results of those consultations public.

#### Article TBT.5: Standards

1. Each Party shall encourage the standardising bodies established within its territory, as well as the regional standardising bodies of which a Party or the standardising bodies established in its territory are members:

- (a) to participate, within the limits of their resources, in the preparation of international standards by relevant international standardising bodies;
- (b) to use relevant international standards as a basis for the standards they develop, except where such international standards would be ineffective or inappropriate, for example because of an insufficient level of protection, fundamental climatic or geographical factors or fundamental technological problems;

---

<sup>4</sup> G/TBT/9, 13 November 2000, Annex 4.



- (c) to avoid duplications of, or overlaps with, the work of international standardising bodies;
- (d) to review national and regional standards that are not based on relevant international standards at regular intervals, with a view to increasing the convergence of those standards with relevant international standards;
- (e) to cooperate with the relevant standardising bodies of the other Party in international standardisation activities, including through cooperation in the international standardising bodies or at regional level;
- (f) to foster bilateral cooperation with the standardising bodies of the other Party; and
- (g) to exchange information between standardising bodies.

2. The Parties shall exchange information on:

- (a) their respective use of standards in support of technical regulations; and
- (b) their respective standardisation processes, and the extent to which they use international, regional or sub-regional standards as a basis for their national standards.

3. Where standards are rendered mandatory in a draft technical regulation or conformity assessment procedure, through incorporation or reference, the transparency obligations set out in Article TBT.7 [Transparency] and in Articles 2 or 5 of the TBT Agreement shall apply.

#### Article TBT.6: Conformity assessment

1. Article TBT.4 [Technical regulations] concerning the preparation, adoption and application of technical regulations shall also apply to conformity assessment procedures, *mutatis mutandis*.

2. Where a Party requires conformity assessment as a positive assurance that a product conforms with a technical regulation, it shall:

- (a) select conformity assessment procedures that are proportionate to the risks involved, as determined on the basis of a risk-assessment;
- (b) consider as proof of compliance with technical regulations the use of a supplier's declaration of conformity, i.e. a declaration of conformity issued by the manufacturer on the sole responsibility of the manufacturer without a mandatory third-party assessment, as assurance of conformity among the options for showing compliance with technical regulations;
- (c) where requested by the other Party, provide information on the criteria used to select the conformity assessment procedures for specific products.

3. Where a Party requires third party conformity assessment as a positive assurance that a product conforms with a technical regulation and it has not reserved this task to a government authority as specified in paragraph 4, it shall:

- (a) use accreditation, as appropriate, as a means to demonstrate technical competence to qualify conformity assessment bodies. Without prejudice to its right to establish requirements for conformity assessment bodies, each Party recognises the valuable role that accreditation

operated with authority derived from government and on a non-commercial basis can play in the qualification of conformity assessment bodies;

- (b) use relevant international standards for accreditation and conformity assessment;
- (c) encourage accreditation bodies and conformity assessment bodies located within its territory to join any relevant functioning international agreements or arrangements for harmonisation or facilitation of acceptance of conformity assessment results;
- (d) if two or more conformity assessment bodies are authorised by a Party to carry out conformity assessment procedures required for placing a product on the market, ensure that economic operators have a choice amongst the conformity assessment bodies designated by the authorities of a Party for a particular product or set of products;
- (e) ensure that conformity assessment bodies are independent of manufacturers, importers and economic operators in general and that there are no conflicts of interest between accreditation bodies and conformity assessment bodies;
- (f) allow conformity assessment bodies to use subcontractors to perform testing or inspections in relation to the conformity assessment, including subcontractors located in the territory of the other Party, and may require subcontractors to meet the same requirements the conformity assessment body must meet to perform such testing or inspections itself; and
- (g) publish on a single website a list of the bodies that it has designated to perform such conformity assessment and the relevant information on the scope of designation of each such body.

4. Nothing in this Article shall preclude a Party from requiring that conformity assessment in relation to specific products is performed by its specified government authorities. If a Party requires that conformity assessment is performed by its specified government authorities, that Party shall:

- (a) limit the conformity assessment fees to the approximate cost of the services rendered and, at the request of an applicant for conformity assessment, explain how any fees it imposes for that conformity assessment are limited to the approximate cost of services rendered; and
- (b) make publicly available the conformity assessment fees.

5. Notwithstanding paragraphs 2 to 4, each Party shall accept a supplier's declaration of conformity as proof of compliance with its technical regulations in those product areas where it does so on the date of entry into force of this Agreement.

6. Each Party shall publish and maintain a list of the product areas referred to in paragraph 5 for information purposes, together with the references to the applicable technical regulations.

7. Notwithstanding paragraph 5, either Party may introduce requirements for the mandatory third party testing or certification of the product areas referred to in that paragraph, provided that such requirements are justified on grounds of legitimate objectives and are proportionate to the purpose of giving the importing Party adequate confidence that products conform with the applicable technical regulations or standards, taking account of the risks that non-conformity would create.

8. A Party proposing to introduce the conformity assessment procedures referred to in paragraph 7 shall notify the other Party at an early stage and shall take the comments of the other Party into account in devising any such conformity assessment procedures.

#### Article TBT.7: Transparency

1. Except where urgent problems of safety, health, environmental protection or national security arise or threaten to arise, each Party shall allow the other Party to provide written comments on notified proposed technical regulations and conformity assessment procedures within a period of at least 60 days from the date of the transmission of the notification of such regulations or procedures to the WTO Central Registry of Notifications. A Party shall give positive consideration to a reasonable request to extend that comment period.

2. Each Party shall provide the electronic version of the full notified text together with the notification. In the event that the notified text is not in one of the official WTO languages, the notifying Party shall provide a detailed and comprehensive description of the content of the measure in the WTO notification format.

3. If a Party receives written comments on its proposed technical regulation or conformity assessment procedure from the other Party, it shall:

- (a) if requested by the other Party, discuss the written comments with the participation of its competent regulatory authority, at a time when they can be taken into account; and
- (b) reply in writing to the comments no later than the date of publication of the technical regulation or conformity assessment procedure.

4. Each Party shall endeavour to publish on a website its responses to the comments it receives following the notification referred to in paragraph 1 no later than on the date of publication of the adopted technical regulation or conformity assessment procedure.

5. Each Party shall, where requested by the other Party, provide information regarding the objectives of, legal basis for and rationale for, any technical regulation or conformity assessment procedure that the Party has adopted or is proposing to adopt.

6. Each Party shall ensure that the technical regulations and conformity assessment procedures it has adopted are published on a website that is accessible free of charge.

7. Each Party shall provide information on the adoption and the entry into force of technical regulations or conformity assessment procedures and the adopted final texts through an addendum to the original notification to the WTO.

8. Each Party shall allow a reasonable interval between the publication of technical regulations and their entry into force, in order to allow time for the economic operators of the other Party to adapt. 'Reasonable interval' means a period of at least six months, unless this would be ineffective in fulfilling the legitimate objectives pursued.

9. A Party shall give positive consideration to a reasonable request from the other Party received prior to the end of the comment period set out in paragraph 1 to extend the period of time between the adoption of the technical regulation and its entry into force, except where the delay would be ineffective in fulfilling the legitimate objectives pursued.

10. Each Party shall ensure that the enquiry point established in accordance with Article 10 of the TBT Agreement provides information and answers in one of the official WTO languages to reasonable enquiries from the other Party or from interested persons of the other Party regarding adopted technical regulations and conformity assessment procedures.

#### Article TBT.8: Marking and labelling

1. The technical regulations of a Party may include or exclusively address mandatory marking or labelling requirements. In such cases, the principles of Article 2.2 of the TBT Agreement apply to these technical regulations.

2. Where a Party requires mandatory marking or labelling of products, all of the following conditions shall apply:

- (a) it shall only require information which is relevant for consumers or users of the product or information that indicates that the product conforms to the mandatory technical requirements;
- (b) it shall not require any prior approval, registration or certification of the labels or markings of products, nor any fee disbursement, as a precondition for placing on its market products that otherwise comply with its mandatory technical requirements unless it is necessary in view of legitimate objectives;
- (c) where the Party requires the use of a unique identification number by economic operators, it shall issue such a number to the economic operators of the other Party without undue delay and on a non-discriminatory basis;
- (d) unless the information listed in points (i), (ii) or (iii) would be misleading, contradictory or confusing in relation to the information that the importing Party requires with respect to the goods, the importing Party shall permit:
  - (i) information in other languages in addition to the language required in the importing Party of the goods;
  - (ii) internationally-accepted nomenclatures, pictograms, symbols or graphics; and
  - (iii) additional information to that required in the importing Party of the goods;
- (e) it shall accept that labelling, including supplementary labelling or corrections to labelling, take place in customs warehouses or other designated areas in the country of import as an alternative to labelling in the country of origin, unless such labelling is required to be carried out by approved persons for reasons of public health or safety; and
- (f) unless it considers that legitimate objectives may be undermined, it shall endeavour to accept the use of non-permanent or detachable labels, or marking or labelling in the accompanying documentation, rather than requiring labels or marking to be physically attached to the product.

#### Article TBT.9: Cooperation on market surveillance and non-food product safety and compliance

1. The Parties recognise the importance of cooperation on market surveillance, compliance and the safety of non-food products for the facilitation of trade and for the protection of consumers and other users, and the importance of building mutual trust based on shared information.
2. To guarantee the independent and impartial functioning of market surveillance, the Parties shall ensure:
  - (a) the separation of market surveillance functions from conformity assessment functions; and
  - (b) the absence of any interests that would affect the impartiality of market surveillance authorities in the performance of their control or supervision of economic operators.
3. The Parties shall cooperate and exchange information in the area of non-food product safety and compliance, which may include in particular the following:
  - (a) market surveillance and enforcement activities and measures;
  - (b) risk assessment methods and product testing;
  - (c) coordinated product recalls or other similar actions;
  - (d) scientific, technical and regulatory matters in order to improve non-food product safety and compliance;
  - (e) emerging issues of significant health and safety relevance;
  - (f) standardisation-related activities;
  - (g) exchanges of officials.
4. The Partnership Council shall use its best endeavours to establish in Annex TBT-XX, as soon as possible and preferably within six months of entry into force of this Agreement, an arrangement for the regular exchange of information between the Rapid Alert System for non-food products (RAPEX), or its successor, and the database relating to market surveillance and product safety established under the General Product Safety Regulations 2005, or its successor, in relation to the safety of non-food products and related preventive, restrictive and corrective measures.

The arrangement shall set out the modalities under which:

- (a) the Union is to provide the United Kingdom with selected information from its RAPEX alert system, or its successor, as referred to in Directive [2001/95/EC](#) of the European Parliament and of the Council of 3 December 2001 on general product safety or its successor;
- (b) the United Kingdom is to provide the Union with selected information from its database relating to market surveillance and product safety established under the General Product Safety Regulations 2005, or its successor; and
- (c) the Parties are to inform each other of any follow-up actions and measures taken in response to the information exchanged.

5. The Partnership Council may establish in Annex TBT-ZZ an arrangement on the regular exchange of information, including the exchange of information by electronic means, regarding measures taken on non-compliant non-food products, other than those covered by paragraph 4.
6. Each Party shall use the information obtained pursuant to paragraphs 3, 4 and 5 for the sole purpose of protecting consumers, health, safety or the environment.
7. Each Party shall treat the information obtained pursuant to paragraphs 3, 4 and 5 as confidential.
8. The arrangements referred to in paragraphs 4 and 5 shall specify the type of information to be exchanged, the modalities for the exchange and the application of confidentiality and personal data protection rules. The Partnership Council shall have the power to adopt decisions in order to determine or amend the arrangements set out in Annexes TBT-XX and TBT-ZZ.
9. For the purposes of this Article, 'market surveillance' means activities conducted and measures taken by market surveillance and enforcement authorities, including activities conducted and measures taken in cooperation with economic operators, on the basis of procedures of a Party to enable that Party to monitor or address safety of products and their compliance with the requirements set out in its laws and regulations.
10. Each Party shall ensure that any measure taken by its market surveillance or enforcement authorities to withdraw or recall from its market or to prohibit or restrict the making available on its market of a product imported from the territory of the other Party, for reasons related to non-compliance with the applicable legislation, is proportionate, states the exact grounds on which the measure is based and is communicated without delay to the relevant economic operator.

#### Article TBT.10: Technical discussions

1. If a Party considers that a draft or proposed technical regulation or conformity assessment procedure of the other Party might have a significant effect on trade between the Parties, it may request technical discussions on the matter. The request shall be made in writing to the other Party and shall identify:
  - (a) the measure at issue;
  - (b) the provisions of this Chapter or of an Annex to this Chapter to which the concerns relate; and
  - (c) the reasons for the request, including a description of the requesting Party's concerns regarding the measure.
2. A Party shall deliver its request to the contact point of the other Party designated pursuant to Article TBT.12 [Contact points].
3. At the request of either Party, the Parties shall meet to discuss the concerns raised in the request, in person or via videoconference or teleconference, within 60 days of the date of the request and shall endeavour to resolve the matter as expeditiously as possible. If a requesting Party believes that the matter is urgent, it may request that any meeting take place within a shorter time frame. In such cases, the responding Party shall give positive consideration to such a request.

#### Article TBT.11: Cooperation

1. The Parties shall cooperate in the field of technical regulations, standards and conformity assessment procedures, where it is in their mutual interest, and without prejudice to the autonomy of their own respective decision-making and legal orders. The Trade Specialised Committee on Technical Barriers to Trade may exchange views with respect to the cooperation activities carried out under this Article or the Annexes to this Chapter.
2. For the purposes of paragraph 1, the Parties shall seek to identify, develop and promote cooperation activities of mutual interest. These activities may in particular relate to:
  - (a) the exchange of information, experience and data related to technical regulations, standards and conformity assessment procedures;
  - (b) ensuring efficient interaction and cooperation of their respective regulatory authorities at international, regional or national level;
  - (c) exchanging information, to the extent possible, about international agreements and arrangements regarding technical barriers to trade to which one or both Parties are party; and
  - (d) establishment of or participation in trade facilitating initiatives.
3. For the purposes of this Article and the provisions on cooperation under the Annexes to this Chapter, the European Commission shall act on behalf of the European Union.

#### Article TBT.12: Contact Points

1. Upon the entry into force of this Agreement, each Party shall designate a contact point for the implementation of this Chapter and shall notify the other Party of the contact details for the contact point, including information regarding the relevant officials. The Parties shall promptly notify each other of any change of those contact details.
2. The contact point shall provide any information or explanation requested by the contact point of the other Party in relation to the implementation of this Chapter within a reasonable period of time and, if possible, within 60 days of the date of receipt of the request.

#### Article TBT.13: Trade Specialised Committee on Technical Barriers to Trade

The Trade Specialised Committee on Technical Barriers to Trade shall supervise the implementation and operation of this Chapter and the Annexes to it and shall promptly clarify and address, where possible, any issue raised by a Party relating to the development, adoption or application of technical regulations, standards and conformity assessment procedures under this Chapter or the TBT Agreement.

### Chapter 5: Customs and trade facilitation

#### Article CUSTMS.1: Objective

The objectives of this Chapter are:

- (a) to reinforce cooperation between the Parties in the area of customs and trade facilitation and to support or maintain, where relevant, appropriate levels of compatibility of their customs legislation and practices with a view to ensuring that relevant legislation and procedures, as well as the administrative capacity of the relevant administrations, fulfil the objectives of promoting trade facilitation while ensuring effective customs controls and effective enforcement of customs legislation and trade related laws and regulations, the proper protection of security and safety of citizens and the respect of prohibitions and restrictions and financial interests of the Parties;
- (b) to reinforce administrative cooperation between the Parties in the field of VAT and mutual assistance in claims related to taxes and duties;
- (c) to ensure that the legislation of each Party is non-discriminatory and that customs procedures are based upon the use of modern methods and effective controls to combat fraud and to promote legitimate trade; and
- (d) to ensure that legitimate public policy objectives, including in relation to security, safety and the fight against fraud are not compromised in any way.

#### Article CUSTMS.1a: Definitions

For the purposes of this Chapter and ANNEX CUSTMS-1 [Authorised Economic Operators] and the Protocol on mutual administrative assistance in customs matters and the Protocol on administrative cooperation and combating fraud in the field of Value Added Tax and on mutual assistance for the recovery of claims relating to taxes and duties, the following definitions apply:

- (a) "Agreement on Pre-shipment Inspection" means the Agreement on Pre-shipment Inspection, contained in Annex 1A to the WTO Agreement;
- (b) "ATA and Istanbul Conventions" means the Customs Convention on the ATA Carnet for the Temporary Admission of Goods done in Brussels on 6 December 1961 and the Istanbul Convention on Temporary Admission done on 26 June 1990;
- (c) "Common Transit Convention" means the Convention of 20 May 1987 on a common transit procedure;
- (d) "Customs Data Model of the WCO" means the library of data components and electronic templates for the exchange of business data and compilation of international standards on data and information used in applying regulatory facilitation and controls in global trade, as published by the WCO Data Model Project Team from time to time;
- (e) "customs legislation" means any legal or regulatory provision applicable in the territory of either Party, governing the entry or import of goods, exit or export of goods, the transit of goods and the placing of goods under any other customs regime or procedure, including measures of prohibition, restriction and control;
- (f) "information" means any data, document, image, report, communication or authenticated copy, in any format, including in electronic format, whether or not processed or analysed;



(g) “person” means any person as defined in point (m) of Article OTH.1 [Definitions] of Title XVII [OTHER PROVISIONS]<sup>5</sup>;

(h) “SAFE Framework” means the SAFE Framework of Standards to Secure and Facilitate Global Trade adopted at the June 2005 World Customs Organisation Session in Brussels and as updated from time to time; and

(i) “WTO Trade Facilitation Agreement” means the Agreement on Trade Facilitation annexed to the Protocol Amending the WTO Agreement (decision of 27 November 2014).

#### Article CUSTMS.2: Customs cooperation

1. The relevant authorities of the Parties shall cooperate on customs matters to support the objectives set out in Article CUSTMS.1 [Objective], taking into account the resources of their respective authorities. For the purpose of this Title [Trade in goods], the Convention of 20 May 1987 on the Simplification of Formalities in Trade in Goods applies.

2. The Parties shall develop cooperation, including in the following areas:

(a) exchanging information concerning customs legislation, the implementation of customs legislation and customs procedures; particularly in the following areas:

(i) the simplification and modernisation of customs procedures;

(ii) the facilitation of transit movements and transshipment;

(iii) relations with the business community; and

(iv) supply chain security and risk management;

(b) working together on the customs-related aspects of securing and facilitating the international trade supply chain in accordance with the SAFE Framework;

(c) considering developing joint initiatives relating to import, export and other customs procedures including technical assistance, as well as towards ensuring an effective service to the business community;

(d) strengthening their cooperation in the field of customs in international organisations such as the WTO and the WCO, and exchanging information or holding discussions with a view to establishing where possible common positions in those international organisations and in UNCTAD, UNECE;

(e) endeavouring to harmonise their data requirements for import, export and other customs procedures by implementing common standards and data elements in accordance with the Customs Data Model of the WCO;

---

<sup>5</sup> For greater certainty, it is understood that, in particular for the purposes of this Chapter, the notion of “person” includes any association of persons lacking the legal status of a legal person but recognized under applicable law as having the capacity to perform legal acts.

- (f) strengthening their cooperation on risk management techniques, including sharing best practices, and, where appropriate, risk information and control results. Where relevant and appropriate, the Parties may also consider mutual recognition of risk management techniques, risk standards and controls and customs security measures; the Parties may also consider, where relevant and appropriate, the development of compatible risk criteria and standards, control measures and priority control areas;
- (g) establishing mutual recognition of Authorised Economic Operator programmes to secure and facilitate trade;
- (h) fostering cooperation between customs and other government authorities or agencies in relation to Authorised Economic Operator programmes, which may be achieved, inter alia, by agreeing on the highest standards, facilitating access to benefits and minimising unnecessary duplication;
- (i) enforcing intellectual property rights by customs authorities, including exchanging information and best practices in customs operations focusing in particular on intellectual property rights enforcement;
- (j) maintaining compatible customs procedures, where appropriate and practicable to do so, including the application of a single administrative document for customs declaration; and
- (k) exchanging, where relevant and appropriate and under arrangements to be agreed, certain categories of customs-related information between the customs authorities of the Parties through structured and recurrent communication, for the purposes of improving risk management and the effectiveness of customs controls, targeting goods at risk in terms of revenue collection or safety and security, and facilitating legitimate trade; such exchanges may include export and import declaration data on trade between the Parties, with the possibility of exploring, through pilot initiatives, the development of interoperable mechanisms to avoid duplication in the submission of such information. Exchanges under this point shall be without prejudice to exchanges of information that may take place between the Parties pursuant to the Protocol on mutual administrative assistance in customs matters.

3. Without prejudice to other forms of cooperation envisaged in this Agreement, the customs authorities of the Parties shall provide each other with mutual administrative assistance in the matters covered by this Chapter in accordance with the Protocol on mutual administrative assistance in customs matters.

4. Any exchange of information between the Parties under this Chapter shall be subject to the confidentiality and protection of information set out in Article 12 of the Protocol on mutual administrative assistance in customs matters [Information exchange and confidentiality], *mutatis mutandis*, as well as to any confidentiality requirements set out in the legislation of the Parties.

#### Article CUSTMS.3: Customs and other trade related legislation and procedures

1. Each Party shall ensure that its customs provisions and procedures:

- (a) are consistent with international instruments and standards applicable in the area of customs and trade, including the WTO Trade Facilitation Agreement, the substantive elements of the Revised Kyoto Convention on the Simplification and Harmonisation of Customs Procedures, the International Convention on the Harmonised Commodity Description and Coding System, as well as the SAFE Framework and the Customs Data Model of the WCO;

- (b) provide the protection and facilitation of legitimate trade taking into account the evolution of trade practices through effective enforcement including in case of breaches of its laws and regulations, duty evasion and smuggling and through ensuring compliance with legislative requirements;
- (c) are based on legislation that is proportionate and non-discriminatory, avoids unnecessary burdens on economic operators, provides for further facilitation for operators with high levels of compliance including favourable treatment with respect to customs controls prior to the release of goods, and ensures safeguards against fraud and illicit or damageable activities while ensuring a high level of protection of security and safety of citizens and the respect of prohibitions and restrictions and financial interests of the parties; and
- (d) contain rules that ensure that any penalty imposed for breaches of customs regulations or procedural requirements is proportionate and non-discriminatory and that the imposition of such penalties does not result in unjustified delays.

Each Party should periodically review its legislation and customs procedures. Customs procedures should also be applied in a manner that is predictable, consistent and transparent.

2. In order to improve working methods and to ensure non-discrimination, transparency, efficiency, integrity and the accountability of operations, each Party shall:

- (a) simplify and review requirements and formalities wherever possible with a view to ensuring the rapid release and clearance of goods;
- (b) work towards the further simplification and standardisation of the data and documentation required by customs and other agencies; and
- (c) promote coordination between all border agencies, both internally and across borders, to facilitate border-crossing processes and enhance control, taking into account joint border controls where feasible and appropriate.

#### Article CUSTMS.4: Release of goods

1. Each Party shall adopt or maintain customs procedures that:

- (a) provide for the prompt release of goods within a period that is no longer than necessary to ensure compliance with its laws and regulations;
- (b) provide for advance electronic submission and processing of documentation and any other required information prior to the arrival of the goods, to enable the release of goods promptly upon arrival if no risk has been identified through risk analysis or if no random checks or other checks are to be performed;
- (c) provide for the possibility, where appropriate and if the necessary conditions are satisfied, of releasing goods for free circulation at the first point of arrival; and
- (d) allow for the release of goods prior to the final determination of customs duties, taxes, fees and charges, if such a determination is not done prior to, or upon arrival, or as rapidly as possible after arrival and provided that all other regulatory requirements have been met.

2. As a condition for such release, each Party may require a guarantee for any amount not yet determined in the form of a surety, a deposit or another appropriate instrument provided for in its laws and regulations. Such guarantee shall not be greater than the amount the Party requires to ensure payment of customs duties, taxes, fees and charges ultimately due for the goods covered by the guarantee. The guarantee shall be discharged when it is no longer required.

3. The Parties shall ensure that the customs and other authorities responsible for border controls and procedures dealing with importation, exportation and transit of goods cooperate with one another and coordinate their activities in order to facilitate trade and expedite the release of goods.

#### Article CUSTMS.5: Simplified customs procedures

1. Each Party shall work towards simplification of its requirements and formalities for customs procedures in order to reduce the time and costs thereof for traders or operators, including small and medium-sized enterprises.

2. Each Party shall adopt or maintain measures allowing traders or operators fulfilling criteria specified in its laws and regulations to benefit from further simplification of customs procedures. Such measures may include *inter alia*:

- (a) customs declarations containing a reduced set of data or supporting documents;
- (b) periodical customs declarations for the determination and payment of customs duties and taxes covering multiple imports within a given period after the release of those imported goods;
- (c) self-assessment of and the deferred payment of customs duties and taxes until after the release of those imported goods; and
- (d) the use of a guarantee with a reduced amount or a waiver from the obligation to provide a guarantee.

3. Where a Party chooses to adopt one of these measures, it will offer, where considered appropriate and practicable by that Party and in accordance with its laws and regulations, these simplifications to all traders who meet the relevant criteria.

#### Article CUSTMS.6: Transit and transshipment

1. For the purposes of Article GOODS.4a [Freedom of Transit], the Common Transit Convention shall apply.

2. Each Party shall ensure the facilitation and effective control of transshipment operations and transit movements through their respective territories.

3. Each Party shall promote and implement regional transit arrangements with a view to facilitating trade in compliance with the Common Transit Convention.

4. Each Party shall ensure cooperation and coordination between all concerned authorities and agencies in their respective territories in order to facilitate traffic in transit.

5. Each Party shall allow goods intended for import to be moved within its territory under customs control from a customs office of entry to another customs office in its territory from where the goods would be released or cleared.

#### Article CUSTMS.7: Risk management

1. Each Party shall adopt or maintain a risk management system for customs controls with a view to reducing the likelihood and the impact of an event which would prevent the correct application of customs legislation, compromise the financial interest of the Parties or pose a threat to the security and safety of the Parties and their residents, to human, animal or plant health, to the environment or to consumers.

2. Customs controls, other than random checks, shall primarily be based on risk analysis using electronic data-processing techniques.

3. Each Party shall design and apply risk management in such a manner as to avoid arbitrary or unjustifiable discrimination, or disguised restrictions to international trade.

4. Each Party shall concentrate customs controls and other relevant border controls on high-risk consignments and shall expedite the release of low-risk consignments. Each Party may also select consignments for such controls on a random basis as part of its risk management.

5. Each Party shall base risk management on the assessment of risk through appropriate selectivity criteria.

#### Article CUSTMS.8: Post-clearance audit

1. With a view to expediting the release of goods, each Party shall adopt or maintain post-clearance audit to ensure compliance with customs and other related laws and regulations.

2. Each Party shall select persons and consignments for post-clearance audits in a risk-based manner, which may include using appropriate selectivity criteria. Each Party shall conduct post-clearance audits in a transparent manner. Where a person is involved in the audit process and conclusive results have been achieved, the Party shall notify the person whose record is audited of the results, the person's rights and obligations and the reasons for the results, without delay.

3. The information obtained in post-clearance audits may be used in further administrative or judicial proceedings.

4. The Parties shall, wherever practicable, use the results of post-clearance audit for risk management purposes.

#### Article CUSTMS.9: Authorised Economic Operators

1. Each Party shall maintain a partnership programme for operators who meet the specified criteria in Annex CUSTMS-1 [Authorised Economic Operators].

2. The Parties shall recognise their respective programmes for Authorised Economic Operators in accordance with Annex CUSTMS-1 [Authorised Economic Operators].

## Article CUSTMS.10: Publication and availability of information

1. Each Party shall ensure that its customs legislation and other trade-related laws and regulations, as well as its general administrative procedures and relevant information of general application that relate to trade, are published and readily available to any interested person in an easily accessible manner, including, as appropriate, through the Internet.

2. Each Party shall promptly publish new legislation and general procedures related to customs and trade facilitation issues as early as possible prior to the entry into force of any such legislation or procedures, and shall promptly publish any changes to and interpretations of such legislation and procedures. Such publication shall include:

- (a) relevant notices of administrative nature;
- (b) importation, exportation and transit procedures (including port, airport, and other entry-point procedures) and required forms and documents;
- (c) applied rates of duty and taxes of any kind imposed on or in connection with importation or exportation;
- (d) fees and charges imposed by or for governmental agencies on or in connection with importation, exportation or transit;
- (e) rules for the classification or valuation of products for customs purposes;
- (f) laws, regulations and administrative rulings of general application relating to rules of origin;
- (g) import, export or transit restrictions or prohibitions;
- (h) penalty provisions against breaches of import, export or transit formalities;
- (i) appeal procedures;
- (j) agreements or parts thereof with any country or countries relating to importation, exportation or transit;
- (k) procedures relating to the administration of tariff quotas;
- (l) hours of operation and operating procedures for customs offices at ports and border crossing points; and
- (m) points of contact for information enquiries.

3. Each Party shall ensure there is a reasonable time period between the publication of new or amended legislation, procedures and fees or charges and their entry into force.

4. Each Party shall make the following available through the internet:

- (a) a description of its importation, exportation and transit procedures, including appeal procedures, informing of the practical steps needed to import and export, and for transit;
- (b) the forms and documents required for importation into, exportation from, or transit through the territory of that Party; and

- (c) contact information regarding enquiry points.

Each party shall ensure that the descriptions, forms, documents and information referred to in points (a), (b) and (c) of the first subparagraph are kept up to date.

5. Each Party shall establish or maintain one or more enquiry points to answer enquiries of governments, traders and other interested parties regarding customs and other trade-related matters within a reasonable time. The Parties shall not require the payment of a fee for answering enquiries.

#### Article CUSTMS.11: Advance rulings

1. Each Party, through its customs authorities, shall issue advance rulings upon application by economic operators setting forth the treatment to be accorded to the goods concerned. Such rulings shall be issued in writing or in electronic format in a time bound manner and shall contain all necessary information in accordance with the legislation of the issuing Party.

2. Advance rulings shall be valid for a period of at least three years from the starting date of their validity unless the ruling no longer conforms to the law or the facts or circumstances supporting the original ruling have changed.

3. A Party may refuse to issue an advance ruling if the question raised in the application is the subject of an administrative or judicial review, or if the application does not relate to any intended use of the advance ruling or any intended use of a customs procedure. If a Party declines to issue an advance ruling, it shall promptly notify the applicant in writing, setting out the relevant facts and the basis for its decision.

4. Each Party shall publish, at least:

- (a) the requirements for applying for an advance ruling, including the information to be provided and the format;
- (b) the time period by which it will issue an advance ruling; and
- (c) the length of time for which the advance ruling is valid.

5. If a Party revokes, modifies, invalidates or annuls an advance ruling, it shall provide written notice to the applicant setting out the relevant facts and the basis for its decision. A Party shall only revoke, modify, invalidate or annul an advance ruling with retroactive effect if the ruling was based on incomplete, incorrect, false or misleading information.

6. An advance ruling issued by a Party shall be binding on that Party in respect of the applicant that sought it. The Party may provide that the advance ruling is binding on the applicant.

7. Each Party shall provide, at the written request of the holder, a review of an advance ruling or of a decision to revoke, modify or invalidate an advance ruling.

8. Each Party shall make publicly available information on advance rulings, taking into account the need to protect personal and commercially confidential information.

9. Advance rulings shall be issued with regard to:

- (a) the tariff classification of goods;
- (b) the origin of goods; and
- (c) any other matter the Parties may agree upon.

#### Article CUSTMS.12: Customs brokers

The customs provisions and procedures of a Party shall not require the mandatory use of customs brokers or other agents. Each Party shall publish its measures on the use of customs brokers. Each Party shall apply transparent, non-discriminatory and proportionate rules if and when licensing customs brokers.

#### Article CUSTMS.13: Pre-shipment inspections

A Party shall not require the mandatory use of pre-shipment inspections as defined in the WTO Agreement on Pre-shipment Inspection, or any other inspection activity performed at destination, by private companies, before customs clearance.

#### Article CUSTMS.14: Review and appeal

1. Each Party shall provide effective, prompt, non-discriminatory and easily accessible procedures that guarantee the right of appeal against administrative actions, rulings and decisions of customs or other competent authorities that affect the import or export of goods or goods in transit.
2. The procedures referred to in paragraph 1 shall include:
  - (a) an administrative appeal to or review by an administrative authority higher than or independent of the official or office that issued the decision; and
  - (b) a judicial appeal or review of the decision.
3. Each Party shall ensure that, in cases where the decision on appeal or review under point (a) of paragraph 2 is not given within the time period provided for in its laws and regulations or is not given without undue delay, the petitioner has the right to further administrative or judicial appeal or review or any other recourse to judicial authority in accordance with that Party's laws and regulations.
4. Each Party shall ensure that the petitioner is provided with the reasons for the administrative decision so as to enable the petitioner to have recourse to appeal or review procedures where necessary.

#### Article CUSTMS.15: Relations with the business community

1. Each Party shall hold timely and regular consultations with trade representatives on legislative proposals and general procedures related to customs and trade facilitation issues. To that end, appropriate consultation between administrations and the business community shall be maintained by each Party.
2. Each Party shall ensure that its customs and related requirements and procedures continue to meet the needs of the trading community, follow best practices, and restrict trade as little as possible.



## Article CUSTMS.16: Temporary admission

1. For the purposes of this Article, 'temporary admission' means the customs procedure under which certain goods, including means of transport, can be brought into a customs territory with conditional relief from the payment of import duties and taxes and without the application of import prohibitions or restrictions of an economic character, on the condition that the goods are imported for a specific purpose and are intended for re-exportation within a specified period without having undergone any change except normal depreciation due to the use made of those goods.
2. Each Party shall grant temporary admission, with total conditional relief from import duties and taxes and without application of import restrictions or prohibitions of economic character, as provided for in its laws and regulations, to the following types of goods:
  - (a) goods for display or use at exhibitions, fairs, meetings or similar events (goods intended for display or demonstration at an event; goods intended for use in connection with the display of foreign products at an event; equipment including interpretation equipment, sound and image recording apparatus and films of an educational, scientific or cultural character intended for use at international meetings, conferences or congresses); products obtained incidentally during the event from temporarily imported goods, as a result of the demonstration of displayed machinery or apparatus;
  - (b) professional equipment (equipment for the press, for sound or television broadcasting which is necessary for representatives of the press, of broadcasting or television organisations visiting the territory of another country for purposes of reporting, in order to transmit or record material for specified programmes; cinematographic equipment necessary for a person visiting the territory of another country in order to make a specified film or films; any other equipment necessary for the exercise of the calling, trade or profession of a person visiting the territory of another country to perform a specified task, insofar as it is not to be used for the industrial manufacture or packaging of goods or (except in the case of hand tools) for the exploitation of natural resources, for the construction, repair or maintenance of buildings or for earth moving and like projects; ancillary apparatus for the equipment mentioned above, and accessories therefor); component parts imported for repair of professional equipment temporarily admitted;
  - (c) goods imported in connection with a commercial operation but whose importation does not in itself constitute a commercial operation (packings which are imported filled for re-exportation empty or filled, or are imported empty for re-exportation filled; containers, whether or not filled with goods, and accessories and equipment for temporarily admitted containers, which are either imported with a container to be re-exported separately or with another container, or are imported separately to be re-exported with a container and component parts intended for the repair of containers granted temporary admission; pallets; samples; advertising films; other goods imported in connection with a commercial operation);
  - (d) goods imported in connection with a manufacturing operation (matrices, blocks, plates, moulds, drawings, plans, models and other similar articles; measuring, controlling and checking instruments and other similar articles; special tools and instruments, imported for use during a manufacturing process); replacement means of production (instruments, apparatus and machines made available to a customer by a supplier or repairer, pending the delivery or repair of similar goods);

- (e) goods imported exclusively for educational, scientific or cultural purposes (scientific equipment, pedagogic material, welfare material for seafarers, and any other goods imported in connection with educational, scientific or cultural activities); spare parts for scientific equipment and pedagogic material which has been granted temporary admission; tools specially designed for the maintenance, checking, gauging or repair of such equipment;
- (f) personal effects (all articles, new or used, which a traveller may reasonably require for his or her personal use during the journey, taking into account all the circumstances of the journey, but excluding any goods imported for commercial purposes); goods imported for sports purposes (sports requisites and other articles for use by travellers in sports contests or demonstrations or for training in the territory of temporary admission);
- (g) tourist publicity material (goods imported for the purpose of encouraging the public to visit another foreign country, in particular in order to attend cultural, religious, touristic, sporting or professional meetings or demonstrations held there);
- (h) goods imported for humanitarian purposes (medical, surgical and laboratory equipment and relief consignments, such as vehicles and other means of transport, blankets, tents, prefabricated houses or other goods of prime necessity, forwarded as aid to those affected by natural disaster and similar catastrophes); and
- (i) animals imported for specific purposes (dressage, training, breeding, shoeing or weighing, veterinary treatment, testing (for example, with a view to purchase), participation in shows, exhibitions, contests, competitions or demonstrations, entertainment (circus animals, etc.), touring (including pet animals of travellers), exercise of function (police dogs or horses; detector dogs, dogs for the blind, etc.), rescue operations, transhumance or grazing, performance of work or transport, medical purposes (delivery of snake poison, etc.).

3. Each Party shall, for the temporary admission of the goods referred to in paragraph 2 and regardless of their origin, accept a carnet as prescribed for the purposes of the ATA and Istanbul Conventions issued in the other Party, endorsed there and guaranteed by an association forming part of the international guarantee chain, certified by the competent authorities and valid in the customs territory of the importing Party.

#### Article CUSTMS 17. Single window

Each Party shall endeavour to establish a single window that enables traders to submit documentation or data required for importation, exportation, or transit of goods through a single entry point to the participating authorities or agencies.

#### Article CUSTMS 18. Facilitation of roll-on, roll-off traffic

1. In recognition of the high volume of sea-crossings and, in particular, the high volume of roll on, roll off traffic between their respective customs territories, the Parties agree to cooperate in order to facilitate such traffic as well as other alternative modes of traffic.

2. The Parties acknowledge:

- (a) the right of each Party to adopt trade facilitating customs formalities and procedures for traffic between the Parties within their respective legal frameworks; and

- (b) the right of ports, port authorities and operators to act, within the legal orders of their respective Parties, in accordance with their rules and their operating and business models.

3. To this effect the Parties:

- (a) shall adopt or maintain procedures allowing for the submission of import documentation and other required information, including manifests, in order to begin processing prior to the arrival of goods with a view to expediting the release of goods upon arrival; and
- (b) undertake to facilitate the use by operators of the transit procedure, including simplifications of the transit procedure as provided for under the Common Transit Convention.

4. The Parties agree to encourage cooperation between their respective customs authorities on bilateral sea-crossing routes, and to exchange information on the functioning of ports handling traffic between them and on the applicable rules and procedures. They will make public, and promote knowledge by operators of, information on the measures they have in place and the processes established by ports to facilitate such traffic.

#### Article CUSTMS.19: Administrative cooperation in VAT and mutual assistance for recovery of taxes and duties

The competent authorities of the Parties shall cooperate with each other to ensure compliance with VAT legislation and in recovering claims relating to taxes and duties in accordance with the Protocol on administrative cooperation and combating fraud in the field of Value Added Tax and on mutual assistance for the recovery of claims relating to taxes and duties.

#### Article CUSTMS. 20: Trade Specialised Committee on Customs Cooperation and Rules of Origin

1. The Trade Specialised Committee on Customs Cooperation and Rules of Origin shall:
  - (a) hold regular consultations; and
  - (b) in relation to the review of the provisions of the Annex CUSTMS-1 [Authorised Economic Operators]:
    - (i) jointly validate programme members to identify strengths and weaknesses in implementing Annex CUSTMS-1 [Authorised Economic Operators]; and
    - (ii) exchange views on data to be shared and treatment of operators.
2. The Trade Specialised Committee on Customs Cooperation and Rules of Origin may adopt decisions or recommendations:
  - (a) on the exchange of customs-related information, on mutual recognition of risk management techniques, risk standards and controls, customs security measures, on advanced rulings, on common approaches to customs valuation and on other issues related to the implementation of this Chapter;
  - (b) on the arrangements relating to the automatic exchange of information as referred to in Article 10 [Automatic exchange of information] of the Protocol on mutual administrative assistance in customs matters, and on other issues relating to the implementation of that Protocol;

- (c) on any issues relating to the implementation of the Annex CUSTMS-1 [Authorised Economic Operators]; and
- (d) on the procedures for the consultation established in Article ORIG.26 [Denial of preferential tariff treatment] on any technical or administrative matters relating to the implementation of Chapter 2 [Rules of Origin] of this Title, including on interpretative notes aimed at ensuring the uniform administration of the rules of origin.

#### Article CUSTMS.21: Amendments

1. The Partnership Council may amend:
  - (a) Annex CUSTMS-1 [Authorised Economic Operators], the Protocol on mutual administrative assistance in customs matters and the list of goods set out in paragraph 2 of CUSTMS.16 [Temporary admission]; and
  - (b) the Protocol on administrative cooperation and combating fraud in the field of Value Added Tax and on mutual assistance for the recovery of claims relating to taxes and duties.
2. The Trade Specialised Committee on Administrative Cooperation in VAT and recovery of taxes and duties may amend the value referred to in Article 33(4) of the Protocol on administrative cooperation and combating fraud in the field of Value Added Tax and on mutual assistance for the recovery of claims relating to taxes and duties.

### *TITLE II: SERVICES AND INVESTMENT*

#### Chapter 1: General provisions

##### Article SERVIN.1.1: Objective and scope

1. The Parties affirm their commitment to establish a favourable climate for the development of trade and investment between them.
2. The Parties reaffirm the right to regulate within their territories to achieve legitimate policy objectives, such as: the protection of public health; social services; public education; safety; the environment, including climate change; public morals; social or consumer protection; privacy and data protection or the promotion and protection of cultural diversity.
3. This Title does not apply to measures affecting natural persons of a Party seeking access to the employment market of the other Party or to measures regarding nationality, citizenship, residence or employment on a permanent basis.
4. This Title shall not prevent a Party from applying measures to regulate the entry of natural persons into, or their temporary stay in, its territory, including those measures necessary to protect the integrity of its borders and to ensure the orderly movement of natural persons across them, provided that such measures are not applied in such a manner as to nullify or impair the benefits accruing to the other Party under the terms of this Title. The sole fact of requiring a visa for natural persons of certain countries and not for those of others shall not be regarded as nullifying or impairing benefits under this Title.
5. This Title does not apply to:

- (a) air services or related services in support of air services<sup>6</sup>, other than:
  - (i) aircraft repair and maintenance services;
  - (ii) computer reservation system services;
  - (iii) ground handling services;
  - (iv) the following services provided using a manned aircraft, subject to compliance with the Parties respective laws and regulations governing the admission of aircrafts to, departure from and operation within, their territory: aerial fire-fighting; flight training; spraying; surveying; mapping; photography; and other airborne agricultural, industrial and inspection services; and
  - (v) the selling and marketing of air transport services;
- (b) audio-visual services;
- (c) national maritime cabotage<sup>7</sup>; and
- (d) inland waterways transport.

6. This Title does not apply to any measure of a Party with respect to public procurement of a good or service purchased for governmental purposes, and not with a view to commercial resale or with a view to use in the supply of a good or service for commercial sale, whether or not that procurement is 'covered procurement' within the meaning of Article PPROC.2 [Incorporation of certain provisions of the GPA and covered procurement].

7. Except for Article SERVIN.2.6 [Performance requirements], this Title does not apply to subsidies or grants provided by the Parties, including government-supported loans, guarantees and insurance.

---

<sup>6</sup> Air services or related services in support of air services include, but are not limited to, the following services: air transportation; services provided by using an aircraft whose primary purpose is not the transportation of goods or passengers, such as aerial fire-fighting, flight training, sightseeing, spraying, surveying, mapping, photography, parachute jumping, glider towing, helicopter-lift for logging and construction, and other airborne agricultural, industrial and inspection services; the rental of aircraft with crew; and airport operation services.

<sup>7</sup> National maritime cabotage covers: for the Union, without prejudice to the scope of activities which may be considered as cabotage under the relevant national legislation, transportation of passengers or goods between a port or point located in a Member State and another port or point located in that same Member State, including on its continental shelf, as provided for in the United Nations Convention on the Law of the Sea, done in Montego Bay, Jamaica, on 10 December 1982, and traffic originating and terminating in the same port or point located in a Member State; for the United Kingdom, transportation of passengers or goods between a port or point located in the United Kingdom and another port or point located in the United Kingdom, including on its continental shelf, as provided for in the United Nations Convention on the Law of the Sea, done in Montego Bay, Jamaica, on 10 December 1982, and traffic originating and terminating in the same port or point located in the United Kingdom.

## Article SERVIN.1.2: Definitions

For the purposes of this Title:

- (a) "activities performed in the exercise of governmental authority" means activities which are performed, including services which are supplied, neither on a commercial basis nor in competition with one or more economic operators<sup>8</sup>;
- (b) "aircraft repair and maintenance services" means such activities when undertaken on an aircraft or a part thereof while it is withdrawn from service and does not include so-called line maintenance;
- (c) "computer reservation system services" means services provided by computerised systems that contain information about air carriers' schedules, availability, fares and fare rules, through which reservations can be made or tickets may be issued;
- (d) "covered enterprise" means an enterprise in the territory of a Party established in accordance with point (h) by an investor of the other Party, in accordance with the applicable law, existing on the date of entry into force of this Agreement or established thereafter;
- (e) "cross-border trade in services" means the supply of a service:
  - (i) from the territory of a Party into the territory of the other Party; or
  - (ii) in the territory of a Party to the service consumer of the other Party;
- (f) "economic activity" means any activity of an industrial, commercial or professional character or activities of craftsmen, including the supply of services, except for activities performed in the exercise of governmental authority;
- (g) "enterprise" means a legal person or a branch or a representative office of a legal person;
- (h) "establishment" means the setting up or the acquisition of a legal person, including through capital participation, or the creation of a branch or representative office in the territory of a Party, with a view to creating or maintaining lasting economic links;
- (i) "ground handling services" means the supply at an airport, on a fee or contract basis, of the following services: airline representation, administration and supervision; passenger handling; baggage handling; ramp services; catering; air cargo and mail handling; fuelling of an aircraft; aircraft servicing and cleaning; surface transport; and flight operations, crew administration and flight planning; ground handling services do not include: self-handling; security; aircraft repair and maintenance; or management or operation of essential centralised airport infrastructure, such as de-icing facilities, fuel distribution systems, baggage handling systems and fixed intra airport transport systems;
- (j) "investor of a Party" means a natural or legal person of a Party that seeks to establish, is establishing or has established an enterprise in accordance with point (h) in the territory of the other Party;

---

<sup>8</sup> For greater certainty, the term "activities performed in the exercise of governmental authority" when used in relation to measures of a Party affecting the supply of services, includes "services supplied in the exercise of governmental authority" as defined in point (p) of Article SERVIN.1.2 [Definitions].

- (k) "legal person of a Party"<sup>9</sup> means:
- (i) for the Union:
    - (A) a legal person constituted or organised under the law of the Union or at least one of its Member States and engaged, in the territory of the Union, in substantive business operations, understood by the Union, in line with its notification of the Treaty establishing the European Community to the WTO (WT/REG39/1), as equivalent to the concept of "effective and continuous link" with the economy of a Member State enshrined in Article 54 of the Treaty on the Functioning of the European Union (TFEU); and
    - (B) shipping companies established outside the Union, and controlled by natural persons of a Member State, whose vessels are registered in, and fly the flag of, a Member State;
  - (ii) for the United Kingdom:
    - (A) a legal person constituted or organised under the law of the United Kingdom and engaged in substantive business operations in the territory of the United Kingdom; and
    - (B) shipping companies established outside the United Kingdom and controlled by natural persons of the United Kingdom, whose vessels are registered in, and fly the flag of, the United Kingdom;
- (l) "operation" means the conduct, management, maintenance, use, enjoyment, or sale or other form of disposal of an enterprise;
- (m) "professional qualifications" means qualifications attested by evidence of formal qualification, professional experience, or other attestation of competence;
- (n) "selling and marketing of air transport services" means opportunities for the air carrier concerned to sell and market freely its air transport services including all aspects of marketing such as market research, advertising and distribution, but not including the pricing of air transport services nor the applicable conditions;
- (o) "service" means any service in any sector except services supplied in the exercise of governmental authority;
- (p) "services supplied in the exercise of governmental authority" means any service which is supplied neither on a commercial basis, nor in competition with one or more service suppliers;
- (q) "service supplier" means any natural or legal person that seeks to supply or supplies a service;

---

<sup>9</sup> For greater certainty, the shipping companies referred to in this point are only considered as legal persons of a Party with respect to their activities relating to the supply of maritime transport services.



- (r) "service supplier of a Party" means a natural or legal person of a Party that seeks to supply or supplies a service.

#### Article SERVIN.1.3: Denial of benefits

1. A Party may deny the benefits of this Title and Title IV [Capital movements, payments, transfers and temporary safeguard measures] of this Heading to an investor or service supplier of the other Party, or to a covered enterprise, if the denying Party adopts or maintains measures related to the maintenance of international peace and security, including the protection of human rights, which:

- (a) prohibit transactions with that investor, service supplier or covered enterprise; or
- (b) would be violated or circumvented if the benefits of this Title and Title IV [Capital movements, payments, transfers and temporary safeguard measures] of this Heading were accorded to that investor, service supplier or covered enterprise, including where the measures prohibit transactions with a natural or legal person which owns or controls any of them.

2. For greater certainty, paragraph 1 is applicable to Title IV [Capital movements, payments, transfers and temporary safeguard measures] of this Heading to the extent that it relates to services or investment with respect to which a Party has denied the benefits of this Title.

#### Article SERVIN.1.4: Review

1. With a view to introducing possible improvements to the provisions of this Title, and consistent with their commitments under international agreements, the Parties shall review their legal framework relating to trade in services and investment, including this Agreement, in accordance with Article FINPROV.3 [Review].

2. The Parties shall endeavour, where appropriate, to review the non-conforming measures and reservations set out in Annex SERVIN-1 [Existing measures], Annex SERVIN-2 [Future measures], Annex SERVIN-3 [Business visitors for establishment purposes, intra-corporate transferees and short-term business visitors] and Annex SERVIN-4 [Contractual service suppliers and independent professionals] and the activities for short term business visitors set out in Annex SERVIN-3 [Business visitors for establishment purposes, intra-corporate transferees and short-term business visitors], with a view to agreeing to possible improvements in their mutual interest.

3. This Article shall not apply with respect to financial services.

### Chapter 2: Investment liberalisation

#### Article SERVIN.2.1: Scope

This Chapter applies to measures of a Party affecting the establishment of an enterprise to perform economic activities and the operation of such an enterprise by:

- (a) investors of the other Party;
- (b) covered enterprises; and
- (c) for the purposes of Article SERVIN.2.6 [Performance requirements], any enterprise in the territory of the Party which adopts or maintains the measure.



## Article SERVIN.2.2: Market access

A Party shall not adopt or maintain, with regard to establishment of an enterprise by an investor of the other Party or by a covered enterprise, or operation of a covered enterprise, either on the basis of its entire territory or on the basis of a territorial sub-division, measures that:

- (a) impose limitations on:
  - (i) the number of enterprises that may carry out a specific economic activity, whether in the form of numerical quotas, monopolies, exclusive rights or the requirement of an economic needs test;
  - (ii) the total value of transactions or assets in the form of numerical quotas or the requirement of an economic needs test;
  - (iii) the total number of operations or on the total quantity of output expressed in terms of designated numerical units in the form of quotas or the requirement of an economic needs test;<sup>10 11</sup>
  - (iv) the participation of foreign capital in terms of maximum percentage limit on foreign shareholding or the total value of individual or aggregate foreign investment; or
  - (v) the total number of natural persons that may be employed in a particular sector or that an enterprise may employ and who are necessary for, and directly related to, the performance of an economic activity, in the form of numerical quotas or the requirement of an economic needs test; or
- (b) restrict or require specific types of legal entity or joint venture through which an investor of the other Party may perform an economic activity.

## Article SERVIN.2.3: National treatment

1. Each Party shall accord to investors of the other Party and to covered enterprises treatment no less favourable than that it accords, in like situations, to its own investors and to their enterprises, with respect to their establishment and operation in its territory.
2. The treatment accorded by a Party under paragraph 1 means:
  - (a) with respect to a regional or local level of government of the United Kingdom, treatment no less favourable than the most favourable treatment accorded, in like situations, by that level of government to investors of the United Kingdom and to their enterprises in its territory; and
  - (b) with respect to a government of, or in, a Member State, treatment no less favourable than the most favourable treatment accorded, in like situations, by that government to investors of that Member State and to their enterprises in its territory.

---

<sup>10</sup> Points (a) (i) to (iii) of Article SERVIN.2.2 [Market access] do not cover measures taken in order to limit the production of an agricultural or fishery product.

<sup>11</sup> Point (a)(iii) of Article SERVIN.2.2 [Market access] does not cover measures by a Party which limit inputs for the supply of services.

#### Article SERVIN.2.4: Most favoured nation treatment

1. Each Party shall accord to investors of the other Party and to covered enterprises treatment no less favourable than that it accords, in like situations, to investors of a third country and to their enterprises, with respect to establishment in its territory.
2. Each Party shall accord to investors of the other Party and to covered enterprises treatment no less favourable than that it accords, in like situations, to investors of a third country and to their enterprises, with respect to operation in its territory.
3. Paragraphs 1 and 2 shall not be construed as obliging a Party to extend to investors of the other Party or to covered enterprises the benefit of any treatment resulting from:
  - (a) an international agreement for the avoidance of double taxation or other international agreement or arrangement relating wholly or mainly to taxation; or
  - (b) measures providing for recognition, including the recognition of the standards or criteria for the authorisation, licencing, or certification of a natural person or enterprise to carry out an economic activity, or the recognition of prudential measures as referred to in paragraph 3 of the GATS Annex on Financial Services.
4. For greater certainty, the “treatment” referred to in paragraphs 1 and 2 does not include investor-to-state dispute settlement procedures provided for in other international agreements.
5. For greater certainty, the existence of substantive provisions in other international agreements concluded by a Party with a third country, or the mere formal transposition of those provisions into domestic law to the extent that it is necessary in order to incorporate them into the domestic legal order, do not in themselves constitute the “treatment” referred to in paragraphs 1 and 2. Measures of a Party pursuant to those provisions may constitute such treatment and thus give rise to a breach of this Article.

#### Article SERVIN.2.5: Senior management and boards of directors

A Party shall not require a covered enterprise to appoint individuals of any particular nationality as executives, managers or members of boards of directors.

#### Article SERVIN.2.6: Performance requirements

1. A Party shall not impose or enforce any requirement, or enforce any commitment or undertaking, in connection with the establishment or operation of any enterprise in its territory:
  - (a) to export a given level or percentage of goods or services;
  - (b) to achieve a given level or percentage of domestic content;
  - (c) to purchase, use or accord a preference to goods produced or services provided in its territory or to purchase goods or services from natural or legal persons or any other entities in its territory;
  - (d) to relate in any way the volume or value of imports to the volume or value of exports or to the amount of foreign exchange inflows associated with such enterprise;

- (e) to restrict sales of goods or services in its territory that such enterprise produces or supplies, by relating those sales in any way to the volume or value of its exports or foreign exchange inflows;
- (f) to transfer technology, a production process or other proprietary knowledge to a natural or legal person or any other entity in its territory<sup>12</sup>;
- (g) to supply exclusively from the territory of that Party a good produced or a service supplied by the enterprise to a specific regional or world market;
- (h) to locate the headquarters for a specific region of the World which is broader than the territory of the Party or the world market in its territory;
- (i) to employ a given number or percentage of natural persons of that Party;
- (j) to achieve a given level or value of research and development in its territory;
- (k) to restrict the exportation or sale for export; or
- (l) with regard to any licence contract in existence at the time the requirement is imposed or enforced, or any commitment or undertaking is enforced, or with regard to any future licence contract freely entered into between the enterprise and a natural or legal person or any other entity in its territory, if the requirement is imposed or enforced or the commitment or undertaking is enforced, in a manner that constitutes direct interference with that licence contract by an exercise of non-judicial governmental authority of a Party, to adopt:
  - (i) a rate or amount of royalty below a certain level; or
  - (ii) a given duration of the term of a licence contract.

This point does not apply where the licence contract is concluded between the enterprise and the Party. For the purposes of this point, a "licence contract" means any contract concerning the licensing of technology, a production process, or other proprietary knowledge.

2. A Party shall not condition the receipt or continued receipt of an advantage, in connection with the establishment or operation of an enterprise in its territory, on compliance with any of the following requirements:

- (a) achieving a given level or percentage of domestic content;
- (b) purchasing, using or according a preference to goods produced or services supplied in its territory, or to purchase goods or services from natural or legal persons or any other entity in its territory;
- (c) relating in any way the volume or value of imports to the volume or value of exports or to the amount of foreign exchange inflows associated with that enterprise;

---

<sup>12</sup> For greater certainty, point (f) of Article SERVIN.2.6(1) [Performance requirements] is without prejudice to the provisions of Article DIGIT.12 [Transfer of or access to source code].

(d) restricting the sales of goods or services in its territory that that enterprise produces or supplies by relating those sales in any way to the volume or value of its exports or foreign exchange inflows; or

(e) restricting the exportation or sale for export.

3. Paragraph 2 shall not be construed as preventing a Party from conditioning the receipt or continued receipt of an advantage, in connection with the establishment or operation of any enterprise in its territory, on compliance with a requirement to locate production, supply a service, train or employ workers, construct or expand particular facilities, or carry out research and development, in its territory.

4. Points (f) and (l) of paragraph 1 do not apply where:

(a) the requirement is imposed or enforced, or the commitment or undertaking is enforced, by a court or administrative tribunal, or by a competition authority pursuant to a Party's competition law to prevent or remedy a restriction or a distortion of competition; or

(b) a Party authorises the use of an intellectual property right in accordance with Article 31 or Article 31bis of the TRIPS Agreement, or adopts or maintains measures requiring the disclosure of data or proprietary information that fall within the scope of, and are consistent with, paragraph 3 of Article 39 of the TRIPS Agreement.

5. Points (a) to (c) of paragraph 1 and points (a) and (b) of paragraph 2 do not apply to qualification requirements for goods or services with respect to participation in export promotion and foreign aid programmes.

6. For greater certainty, this Article does not preclude the enforcement by the competent authorities of a Party of any commitment or undertaking given between persons other than a Party which was not directly or indirectly imposed or required by that Party.

7. For greater certainty, points (a) and (b) of paragraph 2 do not apply to requirements imposed by an importing Party in relation to the content of goods necessary to qualify for preferential tariffs or preferential quotas.

8. Point (l) of paragraph 1 does not apply if the requirement is imposed or enforced, or the commitment or undertaking is enforced, by a tribunal as equitable remuneration under the Party's copyright laws.

9. A Party shall neither impose nor enforce any measure inconsistent with its obligations under the Agreement on Trade-Related Investment Measures (TRIMs), even where such measure has been listed by that Party in ANNEX SERVIN-1 [Existing measures] or ANNEX SERVIN-2 [Future measures].

10. For greater certainty, this Article shall not be construed as requiring a Party to permit a particular service to be supplied on a cross-border basis where that Party adopts or maintains restrictions or prohibitions on such provision of services which are consistent with the reservations, conditions or qualifications specified with respect to a sector, subsector or activity listed in ANNEX SERVIN-1 [Existing measures] or ANNEX SERVIN-2 [Future measures].

11. A condition for the receipt or continued receipt of an advantage referred to in paragraph 2 does not constitute a requirement or a commitment or undertaking for the purposes of paragraph 1.

## Article SERVIN.2.7: Non-conforming measures and exceptions

1. Articles SERVIN.2.2 [Market access], SERVIN.2.3 [National treatment], SERVIN.2.4 [Most favoured nation treatment], SERVIN.2.5 [Senior management and boards of directors] and SERVIN.2.6 [Performance requirements], do not apply to:

(a) any existing non-conforming measure of a Party at the level of:

(i) for the Union:

(A) the Union, as set out in the Schedule of the Union in Annex SERVIN.1 [Existing measures];

(B) The central government of a Member State, as set out in the Schedule of the Union in Annex SERVIN.1 [Existing measures];

(C) a regional government of a Member State, as set out in the Schedule of the Union in Annex SERVIN.1 [Existing measures]; or

(D) a local government, other than that referred to in point (C); and

(ii) for the United Kingdom:

(A) the central government, as set out in the Schedule of the United Kingdom in Annex SERVIN.1 [Existing measures];

(B) a [regional government], as set out in the Schedule of the United Kingdom in Annex SERVIN.1 [Existing measures];

or

(C) a local government;

(b) the continuation or prompt renewal of any non-conforming measure referred to in point (a); or

(c) a modification to any non-conforming measure referred to in points (a) and (b) of this paragraph, provided that it does not decrease the conformity of the measure, as it existed immediately before the modification, with Articles SERVIN.2.2 [Market access], Article SERVIN.2.3 [National treatment], Articles SERVIN.2.4 [Most favoured nation treatment], SERVIN.2.5 [Senior management and boards of directors] or SERVIN.2.6 [Performance requirements].

2. Articles SERVIN.2.2 [Market access], SERVIN.2.3 [National treatment], SERVIN.2.4 [Most favoured nation treatment], SERVIN.2.5 [Senior management and boards of directors] and SERVIN.2.6 [Performance requirements] do not apply to a measure of a Party which is consistent with the reservations, conditions or qualifications specified with respect to a sector, subsector or activity listed in Annex SERVIN.2 [Future measures].

3. Articles SERVIN.2.3 [National treatment] and SERVIN.2.4 [Most favoured nation treatment] do not apply to any measure that constitutes an exception to, or a derogation from, Articles 3 or 4 of the TRIPS Agreement, as specifically provided for in Articles 3 to 5 of that Agreement.

4. For greater certainty, Articles SERVIN.2.3 [National treatment] and SERVIN.2.4 [Most favoured nation treatment] shall not be construed as preventing a Party from prescribing information requirements, including for statistical purposes, in connection with the establishment or operation of investors of the other Party or of covered enterprises, provided that it does not constitute a means to circumvent that Party's obligations under those Articles.

### Chapter 3: Cross-border trade in services

#### Article SERVIN.3.1: Scope

This Chapter applies to measures of a Party affecting the cross-border trade in services by service suppliers of the other Party.

#### Article SERVIN.3.2: Market access

A Party shall not adopt or maintain, either on the basis of its entire territory or on the basis of a territorial sub-division, measures that:

- (a) impose limitations on:
  - (i) the number of services suppliers that may supply a specific service, whether in the form of numerical quotas, monopolies, exclusive service suppliers or the requirement of an economic needs test;
  - (ii) the total value of service transactions or assets in the form of numerical quotas or the requirement of an economic needs test; or
  - (iii) the total number of service operations or on the total quantity of service output expressed in the terms of designated numerical units in the form of quotas or the requirement of an economic needs test<sup>13</sup>; or
- (b) restrict or require specific types of legal entity or joint venture through which a service supplier may supply a service.

#### Article SERVIN.3.3: Local presence

A Party shall not require a service supplier of the other Party to establish or maintain an enterprise or to be resident in its territory as a condition for the cross-border supply of a service.

#### Article SERVIN.3.4: National treatment

1. Each Party shall accord to services and service suppliers of the other Party treatment no less favourable than that it accords, in like situations, to its own services and services suppliers.
2. A Party may meet the requirement of paragraph 1 by according to services and service suppliers of the other Party either formally identical treatment or formally different treatment to that it accords to its own services and service suppliers.

---

<sup>13</sup> Point (a) (iii) of Article SERVIN.3.2 [Market access] does not cover measures by a Party which limit inputs for the supply of services.

3. Formally identical or formally different treatment shall be considered to be less favourable if it modifies the conditions of competition in favour of services or service suppliers of the Party compared to services or service suppliers of the other Party.

4. Nothing in this Article shall be construed as requiring either Party to compensate for inherent competitive disadvantages which result from the foreign character of the relevant services or services suppliers.

#### Article SERVIN.3.5: Most favoured nation treatment

1. Each Party shall accord to services and service suppliers of the other Party treatment no less favourable than that it accords, in like situations, to services and service suppliers of a third country.

2. Paragraph 1 shall not be construed as obliging a Party to extend to services and service suppliers of the other Party the benefit of any treatment resulting from:

- (a) an international agreement for the avoidance of double taxation or other international agreement or arrangement relating wholly or mainly to taxation; or
- (b) measures providing for recognition, including of the standards or criteria for the authorisation, licencing, or certification of a natural person or enterprise to carry out an economic activity, or of prudential measures as referred to in paragraph 3 of the GATS Annex on Financial Services.

3. For greater certainty, the existence of substantive provisions in other international agreements concluded by a Party with a third country, or mere formal transposition of those provisions into domestic law to the extent that it is necessary in order to incorporate them into the domestic legal order, do not in themselves constitute the "treatment" referred to in paragraph 1. Measures of a Party pursuant to those provisions may constitute such treatment and thus give rise to a breach of this Article.

#### Article SERVIN.3.6: Non-conforming measures

1. Articles SERVIN.3.2 [Market access], SERVIN.3.3 [Local presence], SERVIN.3.4 [National treatment] and SERVIN.3.5 [Most favoured nation treatment] do not apply to:

(a) any existing non-conforming measure of a Party at the level of:

(i) for the Union:

- (A) the Union, as set out in the Schedule of the Union in Annex SERVIN-1 [Existing measures];
- (B) the central government of a Member State, as set out in the Schedule of the Union in Annex SERVIN-1 [Existing measures];
- (C) a regional government of a Member State, as set out in the Schedule of the Union in Annex SERVIN-1 [Existing measures]; or
- (D) a local government, other than that referred to in point (C); and

(ii) for the United Kingdom:

- (A) the central government, as set out in the Schedule of the United Kingdom in Annex SERVIN-1 [Existing measures];
  - (B) a regional government, as set out in the Schedule of the United Kingdom in Annex SERVIN-1 [Existing measures]; or
  - (C) a local government;
- (b) the continuation or prompt renewal of any non-conforming measure referred to in point (a); or
- (c) a modification of any non-conforming measure referred to in points (a) and (b) of this paragraph to the extent that it does not decrease the conformity of the measure, as it existed immediately before the modification, with Articles SERVIN.3.2 [Market access], SERVIN.3.3 [Local presence]], SERVIN.3.4 [National treatment] and SERVIN.3.5 [Most favoured nation treatment].
2. Articles 3.2 [Market access], SERVIN.3.3 [Local presence], SERVIN.3.4 [National treatment] and SERVIN.3.5 [Most favoured nation treatment] do not apply to any measure of a Party which is consistent with the reservations, conditions or qualifications specified with respect to a sector, subsector or activity listed in Annex SERVIN-2 [Future measures].

#### Chapter 4: Entry and temporary stay of natural persons for business purposes

##### Article SERVIN.4.1: Scope and definitions

1. This Chapter applies to measures of a Party affecting the performance of economic activities through the entry and temporary stay in its territory of natural persons of the other Party, who are business visitors for establishment purposes, contractual service suppliers, independent professionals, intra-corporate transferees and short-term business visitors.
2. To the extent that commitments are not undertaken in this Chapter, all requirements provided for in the law of a Party regarding the entry and temporary stay of natural persons shall continue to apply, including laws and regulations concerning the period of stay.
3. Notwithstanding the provisions of this Chapter, all requirements provided for in the law of a Party regarding work and social security measures shall continue to apply, including laws and regulations concerning minimum wages and collective wage agreements.
4. Commitments on the entry and temporary stay of natural persons for business purposes do not apply in cases where the intent or effect of the entry and temporary stay is to interfere with or otherwise affect the outcome of any labour or management dispute or negotiation, or the employment of any natural person who is involved in that dispute.
5. For the purposes of this Chapter:
  - (a) "business visitors for establishment purposes" means natural persons working in a senior position within a legal person of a Party, who:
    - (i) are responsible for setting up an enterprise of such legal person in the territory of the other Party;



- (ii) do not offer or provide services or engage in any economic activity other than that which is required for the purposes of the establishment of that enterprise; and
  - (iii) do not receive remuneration from a source located within the other Party;
- (b) "contractual service suppliers" means natural persons employed by a legal person of a Party (other than through an agency for placement and supply services of personnel), which is not established in the territory of the other Party and has concluded a bona fide contract, not exceeding 12 months, to supply services to a final consumer in the other Party requiring the temporary presence of its employees who:
- (i) have offered the same type of services as employees of the legal person for a period of not less than one year immediately preceding the date of their application for entry and temporary stay;
  - (ii) possess, on that date, at least three years professional experience, obtained after having reached the age of majority, in the sector of activity that is the object of the contract, a university degree or a qualification demonstrating knowledge of an equivalent level and the professional qualifications legally required to exercise that activity in the other Party<sup>14</sup>; and
  - (iii) do not receive remuneration from a source located within the other Party;
- (c) "independent professionals" means natural persons engaged in the supply of a service and established as self-employed in the territory of a Party who:
- (i) have not established in the territory of the other Party;
  - (ii) have concluded a bona fide contract (other than through an agency for placement and supply services of personnel) for a period not exceeding 12 months to supply services to a final consumer in the other Party, requiring their presence on a temporary basis; and
  - (iii) possess, on the date of their application for entry and temporary stay, at least six years professional experience in the relevant activity, a university degree or a qualification demonstrating knowledge of an equivalent level and the professional qualifications legally required to exercise that activity in the other Party<sup>15</sup>;
- (d) "intra-corporate transferees" means natural persons, who:
- (i) have been employed by a legal person of a Party, or have been partners in it, for a period, immediately preceding the date of the intra-corporate transfer, of not less than one year in the case of managers and specialists and of not less than six months in the case of trainee employees;
  - (ii) at the time of application reside outside the territory of the other Party;

---

<sup>14</sup> Where the degree or qualification has not been obtained in the Party where the service is supplied, that Party may evaluate whether this is equivalent to a university degree required in its territory.

<sup>15</sup> Where the degree or qualification has not been obtained in the Party where the service is supplied, that Party may evaluate whether this is equivalent to a university degree required in its territory.

- (iii) are temporarily transferred to an enterprise of the legal person in the territory of the other Party which is a member of the same group as the originating legal person, including its representative office, subsidiary, branch or head company<sup>16</sup>; and
- (iv) belong to one of the following categories:
  - (A) managers<sup>17</sup>;
  - (B) specialists; or
  - (C) trainee employees;
- (e) "manager" means a natural person working in a senior position, who primarily directs the management of the enterprise in the other Party, receiving general supervision or direction principally from the board of directors or from shareholders of the business or their equivalent and whose responsibilities include:
  - (i) directing the enterprise or a department or subdivision thereof;
  - (ii) supervising and controlling the work of other supervisory, professional or managerial employees; and
  - (iii) having the authority to recommend hiring, dismissing or other personnel-related actions;
- (f) "specialist" means a natural person possessing specialised knowledge, essential to the enterprise's areas of activity, techniques or management, which is to be assessed taking into account not only knowledge specific to the enterprise, but also whether the person has a high level of qualification, including adequate professional experience of a type of work or activity requiring specific technical knowledge, including possible membership of an accredited profession; and
- (g) "trainee employee" means a natural person possessing a university degree who is temporarily transferred for career development purposes or to obtain training in business techniques or methods and is paid during the period of the transfer.<sup>18</sup>

6. The service contract referred to under points (b) and (c) of paragraph 5 shall comply with the requirements of the law of the Party where the contract is executed.

---

<sup>16</sup> Managers and specialists may be required to demonstrate they possess the professional qualifications and experience needed in the legal person to which they are transferred.

<sup>17</sup> While managers do not directly perform tasks concerning the actual supply of the services, this does not prevent them, in the course of executing their duties as described above, from performing such tasks as may be necessary for the provision of the services.

<sup>18</sup> The recipient enterprise may be required to submit a training programme covering the duration of the stay for prior approval, demonstrating that the purpose of the stay is for training. For AT, CZ, DE, FR, ES, HU and LT, training must be linked to the university degree which has been obtained.

#### Article SERVIN.4.2: Intra-corporate transferees and business visitors for establishment purposes

1. Subject to the relevant conditions and qualifications specified in Annex SERVIN-3 [Business visitors for establishment purposes, intra-corporate transferees, and short-term business visitors]:

- (a) each Party shall allow:
  - (i) the entry and temporary stay of intra-corporate transferees;
  - (ii) the entry and temporary stay of business visitors for establishment purposes without requiring a work permit or other prior approval procedure of similar intent; and
  - (iii) the employment in its territory of intra-corporate transferees of the other Party;
- (b) a Party shall not maintain or adopt limitations in the form of numerical quotas or economic needs tests regarding the total number of natural persons that, in a specific sector, are allowed entry as business visitors for establishment purposes or that an investor of the other Party may employ as intra-corporate transferees, either on the basis of a territorial subdivision or on the basis of its entire territory; and
- (c) each Party shall accord to intra-corporate transferees and business visitors for establishment purposes of the other Party, during their temporary stay in its territory, treatment no less favourable than that it accords, in like situations, to its own natural persons.

2. The permissible length of stay shall be for a period of up to three years for managers and specialists, up to one year for trainee employees and up to 90 days within any six-month period for business visitors for establishment purposes.

#### Article SERVIN.4.3: Short-term business visitors

1. Subject to the relevant conditions and qualifications specified in Annex SERVIN-3 [Business visitors for establishment purposes, intra-corporate transferees and short term business visitors], each Party shall allow the entry and temporary stay of short-term business visitors of the other Party for the purposes of carrying out the activities listed in Annex SERVIN-3 [Business visitors for establishment purposes, intra-corporate transferees and short term business visitors], subject to the following conditions:

- (a) the short-term business visitors are not engaged in selling their goods or supplying services to the general public;
- (b) the short-term business visitors do not, on their own behalf, receive remuneration from within the Party where they are staying temporarily; and
- (c) the short-term business visitors are not engaged in the supply of a service in the framework of a contract concluded between a legal person that has not established in the territory of the Party where they are staying temporarily, and a consumer there, except as provided for in Annex SERVIN-3 [Business visitors for establishment purposes, intra-corporate transferees and short term business visitors].

2. Unless otherwise specified in Annex SERVIN-3 [Business visitors for establishment purposes, intra-corporate transferees and short term business visitors], a Party shall allow entry of short-term

business visitors without the requirement of a work permit, economic needs test or other prior approval procedures of similar intent.

3. If short-term business visitors of a Party are engaged in the supply of a service to a consumer in the territory of the Party where they are staying temporarily in accordance with Annex SERVIN-3 [Business visitors for establishment purposes, intra-corporate transferees and short term business visitors], that Party shall accord to them, with regard to the supply of that service, treatment no less favourable than that it accords, in like situations, to its own service suppliers.

4. The permissible length of stay shall be for a period of up to 90 days in any six-month period.

#### Article SERVIN.4.4: Contractual service suppliers and independent professionals

1. In the sectors, subsectors and activities specified in Annex SERVIN-4 [Contractual service suppliers and independent professionals] and subject to the relevant conditions and qualifications specified therein:

- (a) a Party shall allow the entry and temporary stay of contractual service suppliers and independent professionals in its territory;
- (b) a Party shall not adopt or maintain limitations on the total number of contractual service suppliers and independent professionals of the other Party allowed entry and temporary stay, in the form of numerical quotas or an economic needs test; and
- (c) each Party shall accord to contractual service suppliers and independent professionals of the other Party, with regard to the supply of their services in its territory, treatment no less favourable than that it accords, in like situations, to its own service suppliers.

2. Access accorded under this Article relates only to the service which is the subject of the contract and does not confer entitlement to use the professional title of the Party where the service is provided.

3. The number of persons covered by the service contract shall not be greater than necessary to fulfil the contract, as it may be required by the law of the Party where the service is supplied.

4. The permissible length of stay shall be for a cumulative period of 12 months, or for the duration of the contract, whichever is less.

#### Article SERVIN.4.5: Non-conforming measures

To the extent that the relevant measure affects the temporary stay of natural persons for business purposes, points (b) and (c) of Article SERVIN.4.2(1) [Intra-corporate transferees and business visitors for establishment purposes], Article SERVIN.4.3(3) [Short-term business visitors] and points (b) and (c) of Article SERVIN.4.4(1) [Contractual service suppliers and independent professionals] do not apply to:

(a) any existing non-conforming measure of a Party at the level of:

(i) for the Union:

(A) the Union, as set out in the Schedule of the Union in Annex SERVIN-1 [Existing measures];

- (B) the central government of a Member State, as set out in the Schedule of the Union in Annex SERVIN-1 [Existing measures];
  - (C) a regional government of a Member State, as set out in the Schedule of the Union in Annex SERVIN-1 [Existing measures]; or
  - (D) a local government, other than that referred to in point (C); and
- (ii) for the United Kingdom:
- (A) the central government, as set out in the Schedule of the United Kingdom in Annex SERVIN-1 [Existing measures];
  - (B) a [regional subdivision], as set out in the Schedule of the United Kingdom in Annex SERVIN-1 [Existing measures]; or
  - (C) a local government;
- (b) the continuation or prompt renewal of any non-conforming measure referred to in point (a);
- (c) a modification of any non-conforming measure referred to in points (a) and (b) of this Article to the extent that it does not decrease the conformity of the measure, as it existed immediately before the modification, with points (b) and (c) of Article SERVIN.4.2(1) [Intra-corporate transferees and business visitors for establishment purposes], Article SERVIN.4.3(3) [Short-term business visitors] and points (b) and (c) of Article SERVIN.4.4(1) [Contractual service suppliers and independent professionals]; or
- (d) any measure of a Party consistent with a condition or qualification specified in Annex SERVIN-2 [Future measures].

#### Article SERVIN.4.6: Transparency

1. Each Party shall make publicly available information on relevant measures that pertain to the entry and temporary stay of natural persons of the other Party, referred to in Article SERVIN.4.1(1) [Scope and definitions].
2. The information referred to in paragraph 1 shall, to the extent possible, include the following information relevant to the entry and temporary stay of natural persons:
  - (a) categories of visa, permits or any similar type of authorisation regarding the entry and temporary stay;
  - (b) documentation required and conditions to be met;
  - (c) method of filing an application and options on where to file, such as consular offices or online;
  - (d) application fees and an indicative timeframe of the processing of an application;
  - (e) the maximum length of stay under each type of authorisation described in point (a);
  - (f) conditions for any available extension or renewal;
  - (g) rules regarding accompanying dependants;

- (h) available review or appeal procedures; and
- (i) relevant laws of general application pertaining to the entry and temporary stay of natural persons for business purposes.

3. With respect to the information referred to in paragraphs 1 and 2, each Party shall endeavour to promptly inform the other Party of the introduction of any new requirements and procedures or of the changes in any requirements and procedures that affect the effective application for the grant of entry into, temporary stay in and, where applicable, permission to work in the former Party.

## Chapter 5: Regulatory framework

### *Section 1: Domestic regulation*

#### Article SERVIN.5.1: Scope and definitions

1. This Section applies to measures by the Parties relating to licensing requirements and procedures, qualification requirements and procedures, formalities and technical standards that affect:

- (a) cross-border trade in services;
- (b) establishment or operation; or
- (c) the supply of a service through the presence of a natural person of a Party in the territory of the other Party as set out in Article SERVIN.4.1 [Scope and definitions].

As far as measures relating to technical standards are concerned, this Section only applies to measures that affect trade in services. For the purposes of this Section, the term 'technical standards' does not include regulatory or implementing technical standards for financial services.

2. This Section does not apply to licensing requirements and procedures, qualification requirements and procedures, formalities and technical standards pursuant to a measure:

- (a) that does not conform with Article SERVIN.2.2 [Market access] or 2.3 [National treatment] and is referred to in points (a) to (c) of Article SERVIN.2.7(1) [Non-conforming measures and exceptions] or with Article SERVIN.3.2 [Market access], Article SERVIN.3.3 [Local presence] or Article SERVIN.3.4 [National treatment] and is referred to in points (a) to (c) of Article SERVIN.3.6(1) [Non-conforming measures] or with points (b) and (c) of Article SERVIN 4.2(1) [Intra-corporate transferees and business visitors for establishment purposes], or Article SERVIN 4.3(3) [Short-term business visitors]] or with points (b) and (c) of Article SERVIN 4.4(1) [Contractual service suppliers and independent professionals] and is referred to in Article SERVIN 4.5(1) [Non-conforming measures]; or
- (b) referred to in Article SERVIN.2.7(2) [Non-conforming measures and exceptions] or Article SERVIN.3.6(2) [Non-conforming measures].

3. For the purposes of this Section:

- (a) "authorisation" means the permission to carry out any of the activities referred to in points (a) to (c) of paragraph 1 resulting from a procedure a natural or legal person must adhere to in

order to demonstrate compliance with licensing requirements, qualification requirements, technical standards or formalities for the purposes of obtaining, maintaining or renewing that permission; and

- (b) "competent authority" means a central, regional or local government or authority or non-governmental body in the exercise of powers delegated by central, regional or local governments or authorities, which is entitled to take a decision concerning the authorisation referred to in point (a).

#### Article SERVIN.5.2: Submission of applications

Each Party shall, to the extent practicable, avoid requiring an applicant to approach more than one competent authority for each application for authorisation. If an activity for which authorisation is requested is within the jurisdiction of multiple competent authorities, multiple applications for authorisation may be required.

#### Article SERVIN.5.3: Application timeframes

If a Party requires authorisation, it shall ensure that its competent authorities, to the extent practicable, permit the submission of an application at any time throughout the year. If a specific time period for applying for authorisation exists, the Party shall ensure that the competent authorities allow a reasonable period of time for the submission of an application.

#### Article SERVIN.5.4: Electronic applications and acceptance of copies

If a Party requires authorisation, it shall ensure that its competent authorities:

- (a) to the extent possible provide for applications to be completed by electronic means, including from within the territory of the other Party; and
- (b) accept copies of documents, that are authenticated in accordance with the Party's domestic law, in place of original documents, unless the competent authorities require original documents to protect the integrity of the authorisation process.

#### Article SERVIN.5.5: Processing of applications

1. If a Party requires authorisation, it shall ensure that its competent authorities:

- (a) process applications throughout the year. Where that is not possible, this information should be made public in advance, to the extent feasible;
- (b) to the extent practicable, provide an indicative timeframe for the processing of an application. That timeframe shall be reasonable to the extent practicable;
- (c) at the request of the applicant, provide without undue delay information concerning the status of the application;
- (d) to the extent practicable, ascertain without undue delay the completeness of an application for processing under the Party's domestic laws and regulations;

- (e) if they consider an application complete for the purposes of processing under the Party's domestic laws and regulations,<sup>19</sup> within a reasonable period of time after the submission of the application ensure that:
- (i) the processing of the application is completed; and
  - (ii) the applicant is informed of the decision concerning the application, to the extent possible, in writing;<sup>20</sup>
- (f) if they consider an application incomplete for the purposes of processing under the Party's domestic laws and regulations, within a reasonable period of time, to the extent practicable:
- (i) inform the applicant that the application is incomplete;
  - (ii) at the request of the applicant identify the additional information required to complete the application or otherwise provide guidance on why the application is considered incomplete; and
  - (iii) provide the applicant with the opportunity to provide the additional information that is required to complete the application;<sup>21</sup>
- however, if none of the above is practicable, and the application is rejected due to incompleteness, competent authorities shall ensure that they inform the applicant within a reasonable period of time; and
- (g) if an application is rejected, either upon their own initiative or upon request of the applicant, inform the applicant of the reasons for rejection and of the timeframe for an appeal against that decision and, if applicable, the procedures for resubmission of an application; an applicant shall not be prevented from submitting another application solely on the basis of a previously rejected application.

2. The Parties shall ensure that their competent authorities grant an authorisation as soon as it is established, on the basis of an appropriate examination, that the applicant meets the conditions for obtaining it.

3. The Parties shall ensure that, once granted, an authorisation enters into effect without undue delay, subject to the applicable terms and conditions.<sup>22</sup>

---

<sup>19</sup> Balancing resource constraints against the potential burden on businesses, in cases where it is reasonable to do so, competent authorities may require that all information is submitted in a specified format to consider it "complete for the purposes of processing".

<sup>20</sup> Competent authorities may meet the requirement set out in point (ii) by informing an applicant in advance in writing, including through a published measure, that a lack of response after a specified period of time from the date of submission of the application indicates acceptance of the application. The reference to "in writing" should be understood as including electronic format.

<sup>21</sup> Such "opportunity" does not require a competent authority to provide extensions of deadlines.

<sup>22</sup> Competent authorities are not responsible for delays due to reasons outside their competence.



#### Article SERVIN.5.6: Fees

1. For all economic activities other than financial services, each Party shall ensure that the authorisation fees charged by its competent authorities are reasonable and transparent and do not in themselves restrict the supply of the relevant service or the pursuit of any other economic activity. Having regard to the cost and administrative burden, each Party is encouraged to accept payment of authorisation fees by electronic means.
2. With regard to financial services, each Party shall ensure that its competent authorities, with respect to authorisation fees that they charge, provide applicants with a schedule of fees or information on how fee amounts are determined, and do not use the fees as a means of avoiding the Party's commitments or obligations.
3. Authorisation fees do not include fees for the use of natural resources, payments for auction, tendering or other non-discriminatory means of awarding concessions or mandated contributions to universal service provision.

#### Article SERVIN.5.7: Assessment of qualifications

If a Party requires an examination to assess the qualifications of an applicant for authorisation, it shall ensure that its competent authorities schedule such an examination at reasonably frequent intervals and provide a reasonable period of time to enable applicants to request to take the examination. To the extent practicable, each Party shall accept requests in electronic format to take such examinations and shall consider the use of electronic means in other aspects of examination processes.

#### Article SERVIN.5.8: Publication and information available

1. If a Party requires authorisation, the Party shall promptly publish the information necessary for persons carrying out or seeking to carry out the activities referred to in Article SERVIN.5.1(1) [Scope and definitions] for which the authorisation is required to comply with the requirements, formalities, technical standards and procedures for obtaining, maintaining, amending and renewing such authorisation. Such information shall include, to the extent it exists:
  - (a) the licensing and qualification requirements and procedures and formalities;
  - (b) contact information of relevant competent authorities;
  - (c) authorisation fees;
  - (d) applicable technical standards;
  - (e) procedures for appeal or review of decisions concerning applications;
  - (f) procedures for monitoring or enforcing compliance with the terms and conditions of licences or qualifications;
  - (g) opportunities for public involvement, such as through hearings or comments; and
  - (h) indicative timeframes for the processing of an application.

For the purposes of this Section, "publish" means to include in an official publication, such as an official journal, or on an official website. Parties shall consolidate electronic publications into a single online portal or otherwise ensure that competent authorities make them easily accessible through alternative electronic means.

2. Each Party shall require each of its competent authorities to respond to any request for information or assistance, to the extent practicable.

#### Article SERVIN.5.9: Technical standards

Each Party shall encourage its competent authorities, when adopting technical standards, to adopt technical standards developed through open and transparent processes, and shall encourage any body, including relevant international organisations, designated to develop technical standards to do so through open and transparent processes.

#### Article SERVIN.5.10: Conditions for authorisation

1. Each Party shall ensure that measures relating to authorisation are based on criteria which preclude the competent authorities from exercising their power of assessment in an arbitrary manner and may include, *inter alia*, competence and the ability to supply a service or any other economic activity, including to do so in compliance with a Party's regulatory requirements such as health and environmental requirements. For the avoidance of doubt, the Parties understand that in reaching decisions a competent authority may balance criteria.

2. The criteria referred to in paragraph 1 shall be:

- (a) clear and unambiguous;
- (b) objective and transparent;
- (c) pre-established;
- (d) made public in advance;
- (e) impartial; and
- (f) easily accessible.

3. If a Party adopts or maintains a measure relating to authorisation, it shall ensure that:

- (a) the competent authority concerned processes applications, and reaches and administers its decisions objectively and impartially and in a manner independent of the undue influence of any person carrying out the economic activity for which authorisation is required; and
- (b) the procedures themselves do not prevent fulfilment of the requirements.

#### Article SERVIN.5.11: Limited numbers of licences

If the number of licences available for a given activity is limited because of the scarcity of available natural resources or technical capacity, a Party shall apply a selection procedure to potential candidates which provides full guarantees of impartiality, objectivity and transparency, including, in particular, adequate publicity about the launch, conduct and completion of the procedure. In

establishing the rules for the selection procedure, a Party may take into account legitimate policy objectives, including considerations of health, safety, the protection of the environment and the preservation of cultural heritage.

### *Section 2: Provisions of general application*

#### Article SERVIN.5.12: Review procedures for administrative decisions

A Party shall maintain judicial, arbitral or administrative tribunals or procedures which provide, on request of an affected investor or service supplier of the other Party, for the prompt review of, and if justified appropriate remedies for, administrative decisions that affect establishment or operation, cross-border trade in services or the supply of a service through the presence of a natural person of a Party in the territory of the other Party. For the purposes of this Section, "administrative decisions" means a decision or action with a legal effect that applies to a specific person, good or service in an individual case and covers the failure to take an administrative decision or take such action when that is so required by a Party's law. If such procedures are not independent of the competent authority entrusted with the administrative decision concerned, a Party shall ensure that the procedures in fact provide for an objective and impartial review.

#### Article SERVIN.5.13: Professional qualifications

1. Nothing in this Article shall prevent a Party from requiring that natural persons possess the necessary professional qualifications specified in the territory where the activity is performed, for the sector of activity concerned<sup>23</sup>.
2. The professional bodies or authorities, which are relevant for the sector of activity concerned in their respective territories, may develop and provide joint recommendations on the recognition of professional qualifications to the Partnership Council. Such joint recommendations shall be supported by an evidence-based assessment of:
  - (a) the economic value of an envisaged arrangement on the recognition of professional qualifications; and
  - (b) the compatibility of the respective regimes, that is, the extent to which the requirements applied by each Party for the authorisation, licensing, operation and certification are compatible.
3. On receipt of a joint recommendation, the Partnership Council shall review its consistency with this Title within a reasonable period of time. The Partnership Council may, following such review, develop and adopt an arrangement on the conditions for the recognition of professional qualifications by decision as an annex to this Agreement, which shall be considered to form an integral part of this Title.<sup>24</sup>

---

<sup>23</sup> For greater certainty, this Article shall not be construed to prevent the negotiation and conclusion of one or more agreements between the Parties on the recognition of professional qualifications on conditions and requirements different from those provided for in this Article.

<sup>24</sup> For greater certainty, such arrangements shall not lead to the automatic recognition of qualifications but shall set, in the mutual interest of both Parties, the conditions for the competent authorities granting recognition.

4. An arrangement referred to under paragraph 3 shall provide for the conditions for recognition of professional qualifications acquired in the Union and professional qualifications acquired in the United Kingdom relating to an activity covered by this Title and Title III [Digital Trade] of Heading One.

5. The Guidelines for arrangements on the recognition of professional qualifications set out in Annex SERVIN-6 [Guidelines for arrangements on the recognition of professional qualifications] shall be taken into account in the development of the joint recommendations referred to in paragraph 2 of this Article and by the Partnership Council when assessing whether to adopt such an Arrangement, as referred to in paragraph 3 of this Article.

### *Section 3: Delivery services*

#### Article SERVIN.5.14: Scope and definitions

1. This Section applies to measures of a Party affecting the supply of delivery services in addition to Chapters 1, 2, 3 and 4 of this Title, and to Sections 1 and 2 of this Chapter.

2. For the purposes of this Section:

- (a) "delivery services" means postal services, courier services, express delivery services or express mail services, which include the following activities: the collection, sorting, transport, and delivery of postal items;
- (b) "express delivery services" means the collection, sorting, transport and delivery of postal items at accelerated speed and reliability and may include value added elements such as collection from point of origin, personal delivery to the addressee, tracing, possibility of changing the destination and addressee in transit or confirmation of receipt;
- (c) "express mail services" means international express delivery services supplied through the EMS Cooperative, which is the voluntary association of designated postal operators under Universal Postal Union (UPU);
- (d) "licence" means an authorisation that a regulatory authority of a Party may require of an individual supplier in order for that supplier to offer postal or courier services;
- (e) "postal item" means an item up to 31.5kg addressed in the final form in which it is to be carried by any type of supplier of delivery services, whether public or private and may include items such as a letter, parcel, newspaper or catalogue;
- (f) "postal monopoly" means the exclusive right to supply specified delivery services within a Party's territory or a subdivision thereof pursuant to the law of that Party; and
- (g) "universal service" means the permanent supply of a delivery service of specified quality at all points in the territory of a Party or a subdivision thereof at affordable prices for all users.

#### Article SERVIN.5.15: Universal service

1. Each Party has the right to define the kind of universal service obligation it wishes to maintain and to decide on its scope and implementation. Any universal service obligation shall be administered in a transparent, non-discriminatory and neutral manner with regard to all suppliers subject to the obligation.

2. If a Party requires inbound express mail services to be supplied on a universal service basis, it shall not accord preferential treatment to those services over other international express delivery services.

#### Article SERVIN.5.16: Universal service funding

A party shall not impose fees or other charges on the supply of a delivery service that is not a universal service for the purposes of funding the supply of a universal service. This Article does not apply to generally applicable taxation measures or administrative fees.

#### Article SERVIN.5.17: Prevention of market distortive practices

Each party shall ensure that suppliers of delivery services subject to a universal service obligation or postal monopolies do not engage in market distortive practices such as:

- (a) using revenues derived from the supply of the service subject to a universal service obligation or from a postal monopoly to cross-subsidise the supply of an express delivery service or any delivery service which is not subject to a universal service obligation; or
- (b) unjustifiably differentiating between consumers with respect to tariffs or other terms and conditions for the supply of a service subject to a universal service or a postal monopoly.

#### Article SERVIN.5.18: Licences

1. If a Party requires a licence for the provision of delivery services, it shall make publicly available:

- (a) all the licensing requirements and the period of time normally required to reach a decision concerning an application for a licence; and
- (b) the terms and conditions of licences.

2. The procedures, obligations and requirements of a licence shall be transparent, non-discriminatory and based on objective criteria.

3. If a licence application is rejected by the competent authority, it shall inform the applicant of the reasons for the rejection in writing. Each Party shall establish an appeal procedure through an independent body available to applicants whose licence has been rejected. That body may be a court.

#### Article SERVIN.5.19: Independence of the regulatory body

1. Each Party shall establish or maintain a regulatory body which shall be legally distinct from and functionally independent from any supplier of delivery services. If a Party owns or controls a supplier of delivery services, it shall ensure the effective structural separation of the regulatory function from activities associated with ownership or control.

2. The regulatory bodies shall perform their tasks in a transparent and timely manner and have adequate financial and human resources to carry out the task assigned to them. Their decisions shall be impartial with respect to all market participants.

### *Section 4: Telecommunications services*

## Article SERVIN.5.20: Scope

This Section applies to measures of a Party affecting the supply of telecommunications services in addition to Chapters 1, 2, 3 and 4 of this Title, and to Sections 1 and 2 of this Chapter.

## Article SERVIN.5.21: Definitions

For the purposes of this Section:

- (a) "associated facilities" means associated services, physical infrastructure and other facilities or elements associated with a telecommunications network or telecommunications service which enable or support the supply of services via that network or service or have the potential to do so;
- (b) "end user" means a final consumer of, or subscriber to, a public telecommunications service, including a service supplier other than a supplier of public telecommunications services;
- (c) "essential facilities" means facilities of a public telecommunications network or a public telecommunications service that:
  - (i) are exclusively or predominantly provided by a single or limited number of suppliers; and
  - (ii) cannot feasibly be economically or technically substituted in order to provide a service;
- (d) "interconnection" means the linking of public telecommunications networks used by the same or different suppliers of telecommunications networks or telecommunications services in order to allow the users of one supplier to communicate with users of the same or another supplier or to access services provided by another supplier, irrespective of whether those services are provided by the suppliers involved or any other supplier who has access to the network;
- (e) "international mobile roaming service" means a commercial mobile service provided pursuant to a commercial agreement between suppliers of public telecommunications services that enables an end user to use its home mobile handset or other device for voice, data or messaging services while outside the territory in which the end user's home public telecommunications network is located;
- (f) "Internet access service" means a public telecommunications service that provides access to the Internet and thereby connectivity to virtually all end points of the Internet, irrespective of the network technology and terminal equipment used;
- (g) "leased circuit" means telecommunications services or facilities, including those of a virtual nature, that set aside capacity for the dedicated use by, or availability to, a user between two or more designated points;
- (h) "major supplier" means a supplier of telecommunications networks or telecommunications services which has the ability to materially affect the terms of participation, having regard to price and supply, in a relevant market for telecommunications networks or telecommunications services as a result of control over essential facilities or the use of its position in that market;

- (i) "network element" means a facility or equipment used in supplying a telecommunications service, including features, functions and capabilities provided by means of that facility or equipment;
- (j) "number portability" means the ability of subscribers who so request to retain the same telephone numbers, at the same location in the case of a fixed line, without impairment of quality, reliability or convenience when switching between the same category of suppliers of public telecommunications services;
- (k) "public telecommunications network" means any telecommunications network used wholly or mainly for the provision of public telecommunications services which supports the transfer of information between network termination points;
- (l) "public telecommunications service" means any telecommunications service that is offered to the public generally;
- (m) "subscriber" means any natural or legal person which is party to a contract with a supplier of public telecommunications services for the supply of such services;
- (n) "telecommunications" means the transmission and reception of signals by any electromagnetic means;
- (o) "telecommunications network" means transmission systems and, where applicable, switching or routing equipment and other resources, including network elements which are not active, which permit the transmission and reception of signals by wire, radio, optical, or other electromagnetic means;
- (p) "telecommunications regulatory authority" means the body or bodies charged by a Party with the regulation of telecommunications networks and telecommunications services covered by this Section;
- (q) "telecommunications service" means a service which consists wholly or mainly in the transmission and reception of signals, including broadcasting signals, over telecommunications networks, including those used for broadcasting, but not a service providing, or exercising editorial control over, content transmitted using telecommunications networks and telecommunications services;
- (r) "universal service" means the minimum set of services of specified quality that must be made available to all users, or to a set of users, in the territory of a Party, or in a subdivision thereof, regardless of their geographical location and at an affordable price; and
- (s) "user" means any natural or legal person using a public telecommunications service.

#### Article SERVIN.5.22: Telecommunications regulatory authority

1. Each Party shall establish or maintain a telecommunications regulatory authority that:
  - (a) is legally distinct and functionally independent from any supplier of telecommunications networks, telecommunications services or telecommunications equipment;
  - (b) uses procedures and issues decisions that are impartial with respect to all market participants;

- (c) acts independently and does not seek or take instructions from any other body in relation to the exercise of the tasks assigned to it by law to enforce the obligations set out in Articles SERVIN.5.24 [Interconnection], SERVIN.5.25 [Access and use], SERVIN.5.26 [Resolution of telecommunications disputes], SERVIN.5.28 [Interconnection with major supplies] and SERVIN.5.29 [Access to major suppliers' essential facilities];
- (d) has the regulatory power, as well as adequate financial and human resources, to carry out the tasks mentioned in point (c);
- (e) has the power to ensure that suppliers of telecommunications networks or telecommunications services provide it, promptly upon request, with all the information<sup>25</sup>, including financial information, which is necessary to enable it to carry out the tasks mentioned in point (c); and
- (f) exercises its powers transparently and in a timely manner.

2. Each Party shall ensure that the tasks assigned to the telecommunications regulatory authority are made public in an easily accessible and clear form, in particular where those tasks are assigned to more than one body.

3. A Party that retains ownership or control of suppliers of telecommunications networks or telecommunications services shall ensure the effective structural separation of the regulatory function from activities associated with ownership or control.

4. Each Party shall ensure that a user or supplier of telecommunications networks or telecommunications services affected by a decision of the telecommunications regulatory authority has a right of appeal before an appeal body which is independent of the regulatory authority and other affected parties. Pending the outcome of the appeal, the decision shall stand, unless interim measures are granted in accordance with the Party's law.

#### Article SERVIN.5.23: Authorisation to provide telecommunications networks or services

1. Each Party shall permit the provision of telecommunications networks or telecommunications services without a prior formal authorisation.

2. Each Party shall make publicly available all the criteria, applicable procedures and terms and conditions under which suppliers are permitted to provide telecommunications networks or telecommunications services.

3. Any authorisation criteria and applicable procedures shall be as simple as possible, objective, transparent, non-discriminatory and proportionate. Any obligations and conditions imposed on or associated with an authorisation shall be non-discriminatory, transparent and proportionate, and shall be related to the services or networks provided.

4. Each Party shall ensure that an applicant for an authorisation receives in writing the reasons for any denial or revocation of an authorisation or the imposition of supplier-specific conditions. In such cases, the applicant shall have a right of appeal before an appeal body.

---

<sup>25</sup> Information requested shall be treated in accordance with the requirements of confidentiality.



5. Administrative fees imposed on suppliers shall be objective, transparent, non-discriminatory and commensurate with the administrative costs reasonably incurred in the management, control and enforcement of the obligations set out in this Section<sup>26</sup>.

#### ARTICLE SERVIN.5.24: Interconnection

Each Party shall ensure that a supplier of public telecommunications networks or public telecommunications services has the right and, when so requested by another supplier of public telecommunications networks or public telecommunications services, the obligation to negotiate interconnection for the purposes of providing public telecommunications networks or public telecommunications services.

#### Article SERVIN.5.25: Access and use

1. Each Party shall ensure that any covered enterprise or service supplier of the other Party is accorded access to and use of public telecommunications networks or public telecommunications services on reasonable and non-discriminatory<sup>27</sup> terms and conditions. This obligation shall be applied, *inter alia*, to paragraphs 2 to 5.

2. Each Party shall ensure that covered enterprises or service suppliers of the other Party have access to and use of any public telecommunications network or public telecommunications service offered within or across its border, including private leased circuits, and to this end shall ensure, subject to paragraph 5, that such enterprises and suppliers are permitted:

- (a) to purchase or lease and attach terminal or other equipment which interfaces with the network and which is necessary to conduct their operations;
- (b) to interconnect private leased or owned circuits with public telecommunications networks or with circuits leased or owned by another covered enterprise or service supplier; and
- (c) to use the operating protocols of their choice in their operations, other than as necessary to ensure the availability of telecommunications services to the public generally.

3. Each Party shall ensure that covered enterprises or service suppliers of the other Party may use public telecommunications networks and public telecommunications services for the movement of information within and across borders, including for their intra-corporate communications, and for access to information contained in databases or otherwise stored in machine-readable form in the territory of either Party.

4. Notwithstanding paragraph 3, a Party may take such measures as are necessary to ensure the security and confidentiality of communications, subject to the requirement that such measures are not applied in a manner which would constitute either a disguised restriction on trade in services

---

<sup>26</sup> Administrative fees do not include payments for rights to use scarce resources and mandated contributions to universal service provision.

<sup>27</sup> For the purposes of this Article, “non-discriminatory” means most-favoured-nation and national treatment as defined in Articles SERVIN.2.3 [National treatment], SERVIN.3.3 [Local presence], SERVIN.2.4 [Most favoured nation treatment] and SERVIN.3.4 [National treatment], as well as under terms and conditions no less favourable than those accorded to any other user of like public telecommunications networks or services in like situations.

or a means of arbitrary or unjustifiable discrimination or of nullification or impairment of benefits under this Title.

5. Each Party shall ensure that no condition is imposed on access to and use of public telecommunications networks or services other than as necessary:

- (a) to safeguard the public service responsibilities of suppliers of public telecommunications networks or public telecommunications services, in particular their ability to make their services available to the public generally; or
- (b) to protect the technical integrity of public telecommunications networks or services.

#### Article SERVIN.5.26: Resolution of telecommunications disputes

1. Each Party shall ensure that, in the event of a dispute arising between suppliers of telecommunications networks or telecommunications services in connection with rights and obligations that arise from this Section, and upon request of either party involved in the dispute, the telecommunications regulatory authority issues a binding decision within a reasonable timeframe to resolve the dispute.

2. The decision by the telecommunications regulatory authority shall be made available to the public, having regard to the requirements of business confidentiality. The parties concerned shall be given a full statement of the reasons on which it is based and shall have the right of appeal referred to in Article SERVIN.5.22(4) [Telecommunications regulatory authority].

3. The procedure referred to in paragraphs 1 and 2 shall not preclude either party concerned from bringing an action before a judicial authority.

#### Article SERVIN.5.27: Competitive safeguards on major suppliers

Each Party shall introduce or maintain appropriate measures for the purpose of preventing suppliers of telecommunications networks or telecommunications services who, alone or together, are a major supplier from engaging in or continuing anti-competitive practices. These anti-competitive practices shall include in particular:

- (a) engaging in anti-competitive cross-subsidisation;
- (b) using information obtained from competitors with anti-competitive results; and
- (c) not making available to other services suppliers on a timely basis technical information about essential facilities and commercially relevant information which are necessary for them to provide services.

#### Article SERVIN.5.28: Interconnection with major suppliers

1. Each Party shall ensure that major suppliers of public telecommunications networks or public telecommunications services provide interconnection at any technically feasible point in the network. Such interconnection shall be provided:

- (a) under non-discriminatory terms and conditions (including as regards rates, technical standards, specifications, quality and maintenance) and of a quality no less favourable than

that provided for the own like services of such major supplier, or for like services of its subsidiaries or other affiliates;

- (b) in a timely fashion, on terms and conditions (including as regards rates, technical standards, specifications, quality and maintenance) that are transparent, reasonable, having regard to economic feasibility, and sufficiently unbundled so that the supplier need not pay for network elements or facilities that it does not require for the service to be provided; and
- (c) upon request, at points in addition to the network termination points offered to the majority of users, subject to charges that reflect the cost of construction of necessary additional facilities.

2. The procedures applicable for interconnection to a major supplier shall be made publicly available.

3. Major suppliers shall make publicly available either their interconnection agreements or their reference interconnection offers as appropriate.

#### Article SERVIN.5.29: Access to major suppliers' essential facilities

Each Party shall ensure that major suppliers in its territory make their essential facilities available to suppliers of telecommunications networks or telecommunications services on reasonable, transparent and non-discriminatory terms and conditions for the purpose of providing public telecommunications services, except where this is not necessary to achieve effective competition on the basis of the facts collected and the assessment of the market conducted by the telecommunications regulatory authority. The major supplier's essential facilities may include network elements, leased circuits services and associated facilities.

#### Article SERVIN.5.30: Scarce resources

1. Each Party shall ensure that the allocation and granting of rights of use of scarce resources, including radio spectrum, numbers and rights of way, is carried out in an open, objective, timely, transparent, non-discriminatory and proportionate manner and by taking into account general interest objectives. Procedures, and conditions and obligations attached to rights of use, shall be based on objective, transparent, non-discriminatory and proportionate criteria.

2. The current use of allocated frequency bands shall be made publicly available, but detailed identification of radio spectrum allocated for specific government uses is not required.

3. Parties may rely on market-based approaches, such as bidding procedures, to assign spectrum for commercial use.

4. The Parties understand that measures of a Party allocating and assigning spectrum and managing frequency are not in and of themselves inconsistent with Articles SERVIN.2.2 [Market access] and SERVIN.3.2 [Market access]. Each Party retains the right to establish and apply spectrum and frequency management measures that may have the effect of limiting the number of suppliers of telecommunications services, provided that it does so in a manner consistent with this Agreement. This includes the ability to allocate frequency bands taking into account current and future needs and spectrum availability.

#### Article SERVIN.5.31: Universal service

1. Each Party has the right to define the kind of universal service obligations it wishes to maintain and to decide on their scope and implementation.
2. Each Party shall administer the universal service obligations in a proportionate, transparent, objective and non-discriminatory way, which is neutral with respect to competition and not more burdensome than necessary for the kind of universal service defined by the Party.
3. Each Party shall ensure that procedures for the designation of universal service suppliers are open to all suppliers of public telecommunications networks or public telecommunications services. Such designation shall be made through an efficient, transparent and non-discriminatory mechanism.
4. If a Party decides to compensate the universal service suppliers, it shall ensure that such compensation does not exceed the net cost caused by the universal service obligation.

#### Article SERVIN.5.32: Number portability

Each Party shall ensure that suppliers of public telecommunications services provide number portability on reasonable terms and conditions.

#### Article SERVIN.5.33: Open Internet access

1. Each Party shall ensure that, subject to its laws and regulations, suppliers of Internet access services enable users of those services to:
  - (a) access and distribute information and content, use and provide applications and services of their choice, subject to non-discriminatory, reasonable, transparent and proportionate network management; and
  - (b) use devices of their choice, provided that such devices do not harm the security of other devices, the network or services provided over the network.
2. For greater certainty, nothing in this Article shall prevent the Parties from adopting measures with the aim of protecting public safety with regards to users online.

#### Article SERVIN.5.34: Confidentiality of information

1. Each Party shall ensure that suppliers that acquire information from another supplier in the process of negotiating arrangements pursuant to Articles SERVIN.5.24 [Interconnection], SERVIN.5.25 [Access and use], SERVIN.5.28 [Interconnection with major suppliers] and SERVIN.5.29 [Access to major suppliers' essential facilities] use that information solely for the purpose for which it was supplied and respect at all times the confidentiality of information transmitted or stored.
2. Each Party shall ensure the confidentiality of communications and related traffic data transmitted in the use of public telecommunications networks or public telecommunications services subject to the requirement that measures applied to that end do not constitute a means of arbitrary or unjustifiable discrimination or a disguised restriction on trade in services.

#### Article SERVIN.5.35: Foreign shareholding

With regard to the provision of telecommunications networks or telecommunications services through establishment and notwithstanding Article SERVIN.2.7 [Non-conforming measures and

exceptions], a Party shall not impose joint venture requirements or limit the participation of foreign capital in terms of maximum percentage limits on foreign shareholding or the total value of individual or aggregate foreign investment.

#### Article SERVIN.5.36: International mobile roaming<sup>28</sup>

1. The Parties shall endeavour to cooperate on promoting transparent and reasonable rates for international mobile roaming services in ways that can help promote the growth of trade among the Parties and enhance consumer welfare.
2. Parties may choose to take steps to enhance transparency and competition with respect to international mobile roaming rates and technological alternatives to roaming services, such as:
  - (a) ensuring that information regarding retail rates is easily accessible to end users; and
  - (b) minimising impediments to the use of technological alternatives to roaming, whereby end users visiting the territory of a Party from the territories of other Parties can access telecommunications services using the device of their choice.
3. Each Party shall encourage suppliers of public telecommunications services in its territory to make publicly available information on retail rates for international mobile roaming services for voice, data and text messages offered to their end users when visiting the territory of the other Party.
4. Nothing in this Article shall require a Party to regulate rates or conditions for international mobile roaming services.

#### *Section 5: Financial services*

##### Article SERVIN.5.37 Scope

1. This Section applies to measures of a Party affecting the supply of financial services in addition to Chapters 1, 2, 3 and 4 of this Title, and to Sections 1 and 2 of this Chapter.
2. For the purposes of this Section, the term "activities performed in the exercise of governmental authority" referred to in point (f) of Article SERVIN.1.2 [Definitions] means the following<sup>29</sup>:
  - (a) activities conducted by a central bank or a monetary authority or by any other public entity in pursuit of monetary or exchange rate policies;
  - (b) activities forming part of a statutory system of social security or public retirement plans; and

---

<sup>28</sup> This Article does not apply to intra-European Union roaming services, which are commercial mobile services provided pursuant to a commercial agreement between suppliers of public telecommunications services that enable an end user to use its home mobile handset or other device for voice, data or messaging services in a Member State other than that in which the end user's home public telecommunications network is located.

<sup>29</sup> For greater certainty, this modification applies to "services supplied in exercise of governmental authority" in point (o) of Article SERVIN.1.2 [Definitions] as it applies to "activities performed in the exercise of governmental authority" in point (f) of Article SERVIN.1.2 [Definitions].

- (c) other activities conducted by a public entity for the account or with the guarantee or using the financial resources of the Party or its public entities.

3. For the purposes of the application of point (f) of Article SERVIN.1.2 [Definitions] to this Section, if a Party allows any of the activities referred to in points (b) or (c) of paragraph 2 of this Article to be conducted by its financial service suppliers in competition with a public entity or a financial service supplier, “activities performed in the exercise of governmental authority” does not include those activities.

4. Point (a) of Article SERVIN.1.2 [Definitions] does not apply to services covered by this Section.

#### Article SERVIN.5.38: Definitions

For the purposes of this Title:

- (a) “financial service” means any service of a financial nature offered by a financial service supplier of a Party and includes the following activities:

- (i) insurance and insurance-related services:

- (A) direct insurance (including co-insurance):

- (aa) life;

- (bb) non-life;

- (B) reinsurance and retrocession;

- (C) insurance intermediation, such as brokerage and agency; and

- (D) services auxiliary to insurance, such as consultancy, actuarial, risk assessment and claim settlement services;

- (ii) banking and other financial services (excluding insurance):

- (A) acceptance of deposits and other repayable funds from the public;

- (B) lending of all types, including consumer credit, mortgage credit, factoring and financing of commercial transaction;

- (C) financial leasing;

- (D) all payment and money transmission services, including credit, charge and debit cards, travellers cheques and bankers drafts;

- (E) guarantees and commitments;

- (F) trading for own account or for account of customers, whether on an exchange, in an over-the-counter market or otherwise, the following:

- (aa) money market instruments (including cheques, bills, certificates of deposits);

- (bb) foreign exchange;
  - (cc) derivative products including, but not limited to, futures and options;
  - (dd) exchange rate and interest rate instruments, including products such as swaps, forward rate agreements;
  - (ee) transferable securities; and
  - (ff) other negotiable instruments and financial assets, including bullion;
  - (G) participation in issues of all kinds of securities, including underwriting and placement as agent (whether publicly or privately) and provision of services related to such issues;
  - (H) money broking;
  - (I) asset management, such as cash or portfolio management, all forms of collective investment management, pension fund management, custodial, depository and trust services;
  - (J) settlement and clearing services for financial assets, including securities, derivative products, and other negotiable instruments;
  - (K) provision and transfer of financial information, and financial data processing and related software; and
  - (L) advisory, intermediation and other auxiliary financial services on all the activities listed in points (A) to (K), including credit reference and analysis, investment and portfolio research and advice, advice on acquisitions and on corporate restructuring and strategy;
- (b) "financial service supplier" means any natural or legal person of a Party that seeks to supply or supplies financial services and does not include a public entity;
- (c) "new financial service" means a service of a financial nature including services related to existing and new products or the manner in which a product is delivered, that is not supplied by any financial service supplier in the territory of a Party but which is supplied in the territory of the other Party;
- (d) "public entity" means:
- (i) a government, a central bank or a monetary authority, of a Party, or an entity owned or controlled by a Party, that is principally engaged in carrying out governmental functions or activities for governmental purposes, not including an entity principally engaged in supplying financial services on commercial terms; or
  - (ii) a private entity, performing functions normally performed by a central bank or monetary authority, when exercising those functions;

- (e) "self-regulatory organisation" means any non-governmental body, including a securities or futures exchange or market, clearing agency, other organisation or association, that exercises regulatory or supervisory authority over financial service suppliers by statute or delegation from central, regional or local governments or authorities, where applicable.

#### Article SERVIN.5.39: Prudential carve-out

1. Nothing in this Agreement shall prevent a Party from adopting or maintaining measures for prudential reasons<sup>30</sup>, such as:

- (a) the protection of investors, depositors, policy-holders or persons to whom a fiduciary duty is owed by a financial service supplier; or
- (b) ensuring the integrity and stability of a Party's financial system.

2. Where such measures do not conform with the provisions of this Agreement, they shall not be used as a means of avoiding the Party's commitments or obligations under the Agreement.

#### Article SERVIN.5.40: Confidential information

Without prejudice to Part Three [Law enforcement and judicial cooperation in criminal matters], nothing in this Agreement shall be construed to require a Party to disclose information relating to the affairs and accounts of individual consumers or any confidential or proprietary information in the possession of public entities.

#### Article SERVIN.5.41: International standards

The Parties shall make their best endeavours to ensure that internationally agreed standards in the financial services sector for regulation and supervision, for the fight against money laundering and terrorist financing and for the fight against tax evasion and avoidance, are implemented and applied in their territory. Such internationally agreed standards are, *inter alia*, those adopted by: the G20; the Financial Stability Board; the Basel Committee on Banking Supervision, in particular its "Core Principle for Effective Banking Supervision"; the International Association of Insurance Supervisors, in particular its "Insurance Core Principles"; the International Organisation of Securities Commissions, in particular its "Objectives and Principles of Securities Regulation"; the Financial Action Task Force; and the Global Forum on Transparency and Exchange of Information for Tax Purposes of the Organisation for Economic Cooperation and Development.

#### Article SERVIN.5.42: Financial services new to the territory of a Party

1. Each Party shall permit a financial service supplier of the other Party established in its territory to supply any new financial service that it would permit its own financial service suppliers to supply in accordance with its law in like situations, provided that the introduction of the new financial service does not require the adoption of a new law or the amendment of an existing law. This does not apply to branches of the other Party established in the territory of a Party.

2. A Party may determine the institutional and legal form through which the service may be supplied and require authorisation for the supply of the service. Where such authorisation is

---

<sup>30</sup> For greater certainty, this shall not prevent a Party from adopting or maintaining measures for prudential reasons in relation to branches established in its territory by legal persons in the other Party.



required, a decision shall be made within a reasonable time and the authorisation may only be refused for prudential reasons.

#### Article SERVIN.5.43: Self-regulatory organisations

Where a Party requires membership of, participation in, or access to, any self-regulatory organisation in order for financial service suppliers of the other Party to supply financial services in its territory, the Party shall ensure observance by that self-regulatory organisation of the obligations under Articles SERVIN.2.3 [National treatment], SERVIN.2.4 [Most favoured nation treatment], and SERVIN.3.4 [National treatment] and SERVIN.3.5 [Most favoured nation treatment].

#### Article SERVIN.5.44: Clearing and payment systems

Under terms and conditions that accord national treatment, each Party shall grant to financial service suppliers of the other Party established in its territory access to payment and clearing systems operated by public entities, and to official funding and refinancing facilities available in the normal course of ordinary business. This Article does not confer access to the Party's lender of last resort facilities.

### *Section 6: International maritime transport services*

#### Article SERVIN.5.45: Scope and definitions

1. This Section applies to measures of a Party affecting the supply of international maritime transport services in addition to Chapters 1, 2, 3, 4 and Section 1 of this Chapter.
2. For the purposes of this Section and Chapters 1, 2, 3 and 4 of this Title:
  - (a) "international maritime transport services" means the transport of passengers or cargo by sea-going vessels between a port of one Party and a port of the other Party or of a third country, or between ports of different Member States, including the direct contracting with providers of other transport services, with a view to covering door-to-door or multimodal transport operations under a single transport document, but does not include the right to provide such other transport services;
  - (b) "door-to-door or multimodal transport operations" means the transport of international cargo using more than one mode of transport, that includes an international sea-leg, under a single transport document;
  - (c) "international cargo" means cargo transported between a port of one Party and a port of the other Party or of a third country, or between ports of different Member States;
  - (d) "maritime auxiliary services" means maritime cargo handling services, customs clearance services, container station and depot services, maritime agency services and, maritime freight forwarding services and storage and warehousing services;
  - (e) "maritime cargo handling services" means activities exercised by stevedore companies, including terminal operators but not including the direct activities of dockers if the workforce is organised independently of the stevedoring or terminal operator companies; the activities covered include the organisation and supervision of:
    - (i) loading or discharging of cargo to or from a ship;

- (ii) the lashing or unlashings of cargo; and
  - (iii) the reception or delivery and safekeeping of cargoes before shipment or after discharge;
- (f) "customs clearance services" means activities consisting in carrying out, on behalf of another party, customs formalities concerning import, export or through transport of cargoes, irrespective of whether these services are the main activity of the service supplier or a usual complement of its main activity;
- (g) "container station and depot services" means activities that consist of storing, stuffing, stripping or repairing of containers and making containers available for shipment, whether in port areas or inland;
- (h) "maritime agency services" means activities that consist of representing, within a given geographic area, as an agent the business interests of one or more shipping lines or shipping companies, for the following purposes:
- (i) marketing and sales of maritime transport and related services, from quotation to invoicing, issuance of bills of lading on behalf of the lines or companies, acquisition and resale of the necessary related services, preparation of documentation and provision of business information; and
  - (ii) acting on behalf of the lines or companies organising the call of the ship or taking over cargoes when required;
- (i) "feeder services" means, without prejudice to the scope of activities, which might be considered as cabotage under the relevant national legislation, the pre- and onward transportation by sea of international cargo, including containerised, break bulk and dry or liquid bulk cargo, between ports located in the territory of a Party, provided such international cargo is "en route", that is, directed to a destination, or coming from a port of shipment, outside the territory of that Party;
- (j) "maritime freight forwarding services" means the activity consisting of organising and monitoring shipment operations on behalf of shippers, through the arrangement of transport and related services, preparation of documentation and provision of business information;
- (k) "port services" means services provided inside a maritime port area or on the waterway access to such area by the managing body of a port, its subcontractors, or other service providers to support the transport of cargo or passengers; and
- (l) "storage and warehousing services" means storage services of frozen or refrigerated goods, bulk storage services of liquids or gases, and other storage or warehousing services.

#### Article SERVIN.5.46: Obligations

1. Without prejudice to non-conforming measures or other measures referred to in Articles SERVIN.2.7 [Non-conforming measures and exceptions] and SERVIN.3.6 [Non-conforming measures], each Party shall implement the principle of unrestricted access to the international maritime markets and trades on a commercial and non-discriminatory basis by:

- (a) according to ships flying the flag of the other Party, or operated by service suppliers of the other Party, treatment no less favourable than that accorded to its own ships with regard to, *inter alia*:
    - (i) access to ports;
    - (ii) the use of port infrastructure;
    - (iii) the use of maritime auxiliary services; and
    - (iv) customs facilities and the assignment of berths and facilities for loading and unloading; including related fees and charges;
  - (b) making available to international maritime transport service suppliers of the other Party, on terms and conditions which are both reasonable and no less favourable than those applicable to its own suppliers or vessels or to vessels or suppliers of a third country (including fees and charges, specifications and quality of the service to be provided), the following port services: pilotage, towing and tug assistance, provisioning, fuelling and watering, garbage collecting and ballast waste disposal, port captain's services, navigation aids, emergency repair facilities, anchorage, berth, berthing and unberthing services and shore-based operational services essential to ship operations, including communications, water and electrical supplies;
  - (c) permitting international maritime transport service suppliers of the other Party, subject to the authorisation by the competent authority where applicable, to re-position owned or leased empty containers, which are not being carried as cargo against payment, between ports of the United Kingdom or between ports of a Member State; and
  - (d) permitting international maritime transport service suppliers of the other Party to provide feeder services between ports of the United Kingdom or between ports of a Member State, subject to the authorisation by the competent authority where applicable.
2. In applying the principle referred to in paragraph 1, a Party shall:
- (a) not introduce cargo-sharing arrangements in future agreements with third countries concerning international maritime transport services, including dry and liquid bulk and liner trade, and terminate, within a reasonable period of time, such cargo-sharing arrangements in case they exist in previous agreements;
  - (b) not adopt or maintain a measure that requires all or part of any international cargo to be transported exclusively by vessels registered in that Party or owned or controlled by natural persons of that Party;
  - (c) abolish and abstain from introducing any unilateral measures or administrative, technical and other obstacles which could constitute a disguised restriction or have discriminatory effects on the free supply of international maritime transport services; and
  - (d) not prevent international maritime transport service suppliers of the other Party from directly contracting with other transport service suppliers for door-to-door or multimodal transport operations.

#### *Section 7: Legal services*

#### Article SERVIN.5.47: Scope

1. This Section applies to measures of a Party affecting the supply of designated legal services in addition to Chapters 1, 2, 3, 4 of this Title and to Sections 1 and 2 of this Chapter.
2. Nothing in this Section shall affect the right of a Party to regulate and supervise the supply of designated legal services in its territory in a non-discriminatory manner.

#### Article SERVIN.5.48: Definitions

For the purposes of this Section:

- (a) "designated legal services" means legal services in relation to home jurisdiction law and public international law, excluding Union law;
- (b) "home jurisdiction" means the jurisdiction (or a part of the jurisdiction) of the Member State or of the United Kingdom in which a lawyer acquired their home jurisdiction professional title or, in the case of a lawyer who has acquired a home jurisdiction professional title in more than one jurisdiction, any of those jurisdictions;
- (c) "home jurisdiction law" means the law of the lawyer's home jurisdiction<sup>31</sup>;
- (d) "home jurisdiction professional title" means:
  - (i) for a lawyer of the Union, a professional title acquired in a Member State authorising the supply of legal services in that Member State; or
  - (ii) for a lawyer of the United Kingdom, the title of advocate, barrister or solicitor, authorising the supply of legal services in any part of the jurisdiction of the United Kingdom;
- (e) "lawyer" means:
  - (i) a natural person of the Union who is authorised in a Member State to supply legal services under a home jurisdiction professional title; or
  - (ii) a natural person of the United Kingdom who is authorised in any part of the jurisdiction of the United Kingdom to supply legal services under a home jurisdiction professional title;
- (f) "lawyer of the other Party" means:
  - (i) where "the other Party" is the Union, a lawyer referred to in point (e) (i); or
  - (ii) where "the other Party" is the United Kingdom, a lawyer referred to in point (e) (ii); and
- (g) "legal services" means the following services:
  - (i) legal advisory services; and
  - (ii) legal arbitration, conciliation and mediation services (but excluding such services when supplied by natural persons as set out in Article SERVIN 4.1 [Scope and definitions]).<sup>32</sup>

---

<sup>31</sup> For greater certainty, for the purposes of this Title, European Union law is part of the home jurisdiction law of the lawyers referred to in point (e) (i) of Article SERVIN 5.48 [Definitions].

<sup>32</sup> "Legal arbitration, conciliation and mediation services" means the preparation of documents to be submitted to, the preparation for and appearance before, an arbitrator, conciliator or mediator in any dispute involving the application and interpretation of law. It does not include arbitration, conciliation and mediation services in disputes not involving the application and interpretation of law, which fall under services incidental to management consulting. It also does not include acting as an arbitrator, conciliator or mediator. As a sub-category, international legal arbitration, conciliation or mediation services refers to the same services when the dispute involves parties from two or more countries.

"Legal services" do not include legal representation before administrative agencies, the courts, and other duly constituted official tribunals of a Party, legal advisory and legal authorisation, documentation and certification services supplied by legal professionals entrusted with public functions in the administration of justice such as notaries, "huissiers de justice" or other "officiers publics et ministériels", and services supplied by bailiffs who are appointed by an official act of government.

#### Article SERVIN.5.49: Obligations

1. A Party shall allow a lawyer of the other Party to supply in its territory designated legal services under that lawyer's home jurisdiction professional title in accordance with Articles SERVIN 2.2 [Market access], SERVIN 2.3 [National treatment], SERVIN 3.2 [Market access], SERVIN 3.4 [National treatment] and SERVIN 4.4. [Contractual service suppliers and independent professionals].
2. Where a Party (the host jurisdiction) requires registration in its territory as a condition for a lawyer of the other Party to supply designated legal services pursuant to paragraph 1, the requirements and process for such registration shall not:
  - (a) be less favourable than those which apply to a natural person of a third country who is supplying legal services in relation to third country law or public international law under that person's third-country professional title in the territory of the host jurisdiction; and
  - (b) amount to or be equivalent to any requirement to requalify into or be admitted to the legal profession of the host jurisdiction.
3. Paragraph 4 applies to the provision of designated legal services pursuant to paragraph 1 through establishment.
4. A Party shall allow a legal person of the other Party to establish a branch in its territory through which designated legal services<sup>33</sup> are supplied pursuant to paragraph 1, in accordance with and subject to the conditions set out in Chapter 2 [Investment Liberalisation] of this Title. This shall be without prejudice to requirements that a certain percentage of the shareholders, owners, partners, or directors of a legal person be qualified or practice a certain profession such as lawyers or accountants.

#### Article SERVIN.5.50: Non-conforming measures

1. Article 5.49 [Obligations] does not apply to:
  - (a) any existing non-conforming measure of a Party at a level of:
    - (i) for the Union:
      - (A) the Union, as set out in the Schedule of the Union in Annex SERVIN-1 [Existing measures];
      - (B) the central government of a Member State, as set out in the Schedule of the Union in Annex SERVIN-1 [Existing measures];
      - (C) a regional government of a Member State, as set out in the Schedule of the Union in Annex SERVIN-1 [Existing measures]; or

---

<sup>33</sup> For greater certainty, for the purposes of this paragraph "designated legal services" means, for services supplied in the Union, legal services in relation to the law of the United Kingdom or any part of it and public international law (excluding Union law), and for services supplied in the United Kingdom, legal services in relation to the law of the Member States (including Union law) and public international law (excluding Union law).

- (D) a local government, other than that referred to in point (C); and
- (ii) for the United Kingdom:
- (A) the central government, as set out in the Schedule of the United Kingdom in Annex SERVIN-1 [Existing measures];
  - (B) a regional government, as set out in the Schedule of the United Kingdom in Annex SERVIN-1 [Existing measures]; or
  - (C) a local government;
- (b) the continuation or prompt renewal of any non-conforming measure referred to in point (a); or
- (c) a modification to any non-conforming measure referred to in points (a) and (b) to the extent that it does not decrease the conformity of the measure as it existed immediately before the modification with Article SERVIN 5.49 [Obligations].
2. Article SERVIN 5.49 [Obligations] does not apply to any measure of a Party which is consistent with the reservations, conditions or qualifications specified with respect to a sector, subsector or activity listed in Annex SERVIN-2 [Future Measures].
3. This Section applies without prejudice to Annex SERVIN-4 [Contractual service suppliers and independent professionals].

### *TITLE III: DIGITAL TRADE*

#### Chapter 1: General provisions

##### Article DIGIT.1 Objective

The objective of this Title is to facilitate digital trade, to address unjustified barriers to trade enabled by electronic means and to ensure an open, secure and trustworthy online environment for businesses and consumers.

##### Article DIGIT.2 Scope

1. This Title applies to measures of a Party affecting trade enabled by electronic means.
2. This Title does not apply to audio-visual services.

##### Article DIGIT.3 Right to regulate

The Parties reaffirm the right to regulate within their territories to achieve legitimate policy objectives, such as the protection of public health, social services, public education, safety, the environment including climate change, public morals, social or consumer protection, privacy and data protection, or the promotion and protection of cultural diversity.

##### Article DIGIT.4 Exceptions

For greater certainty, nothing in this Title prevents the Parties from adopting or maintaining measures in accordance with Article EXC.1 [General exceptions], Article EXC.4 [Security exceptions] and Article SERVIN.5.39 [Prudential carve-out] for the public interest reasons set out therein.

## Article DIGIT.5 Definitions

1. The definitions in Article SERVIN.1.2 [Definitions] of Title II [Services and investment] of this Heading apply to this Title.
2. For the purposes of this Title:
  - (a) "consumer" means any natural person using a public telecommunications service for other than professional purposes;
  - (b) "direct marketing communication" means any form of commercial advertising by which a natural or legal person communicates marketing messages directly to a user via a public telecommunications service and covers at least electronic mail and text and multimedia messages (SMS and MMS);
  - (c) "electronic authentication" means an electronic process that enables the confirmation of:
    - (i) the electronic identification of a natural or legal person, or
    - (ii) the origin and integrity of data in electronic form;
  - (d) "electronic registered delivery service" means a service that makes it possible to transmit data between third parties by electronic means and provides evidence relating to the handling of the transmitted data, including proof of sending and receiving the data, and that protects transmitted data against the risk of loss, theft, damage or any unauthorised alterations;
  - (e) "electronic seal" means data in electronic form used by a legal person which is attached to or logically associated with other data in electronic form to ensure the latter's origin and integrity;
  - (f) "electronic signature" means data in electronic form which is attached to or logically associated with other data in electronic form that:
    - (i) is used by a natural person to agree on the data in electronic form to which it relates; and
    - (ii) is linked to the data in electronic form to which it relates in such a way that any subsequent alteration in the data is detectable;
  - (g) "electronic time stamp" means data in electronic form which binds other data in electronic form to a particular time establishing evidence that the latter data existed at that time;
  - (h) "electronic trust service" means an electronic service consisting of:
    - (i) the creation, verification and validation of electronic signatures, electronic seals, electronic time stamps, electronic registered delivery services and certificates related to those services;
    - (ii) the creation, verification and validation of certificates for website authentication; or
    - (iii) the preservation of electronic signatures, seals or certificates related to those services;

- (i) "government data" means data owned or held by any level of government and by non-governmental bodies in the exercise of powers conferred on them by any level of government;
- (j) "public telecommunications service" means any telecommunications service that is offered to the public generally;
- (k) "user" means any natural or legal person using a public telecommunications service.

## Chapter 2: Data flows and personal data protection

### Article DIGIT.6 Cross-border data flows

1. The Parties are committed to ensuring cross-border data flows to facilitate trade in the digital economy. To that end, cross-border data flows shall not be restricted between the Parties by a Party:

- (a) requiring the use of computing facilities or network elements in the Party's territory for processing, including by imposing the use of computing facilities or network elements that are certified or approved in the territory of a Party;
- (b) requiring the localisation of data in the Party's territory for storage or processing;
- (c) prohibiting the storage or processing in the territory of the other Party; or
- (d) making the cross-border transfer of data contingent upon use of computing facilities or network elements in the Parties' territory or upon localisation requirements in the Parties' territory.

2. The Parties shall keep the implementation of this provision under review and assess its functioning within three years of the date of entry into force of this Agreement. A Party may at any time propose to the other Party to review the list of restrictions listed in paragraph 1. Such a request shall be accorded sympathetic consideration.

### Article DIGIT.7 Protection of personal data and privacy

1. Each Party recognises that individuals have a right to the protection of personal data and privacy and that high standards in this regard contribute to trust in the digital economy and to the development of trade.

2. Nothing in this Agreement shall prevent a Party from adopting or maintaining measures on the protection of personal data and privacy, including with respect to cross-border data transfers, provided that the law of the Party provides for instruments enabling transfers under conditions of general application<sup>34</sup> for the protection of the data transferred.

3. Each Party shall inform the other Party about any measure referred to in paragraph 2 that it adopts or maintains.

---

<sup>34</sup> For greater certainty, "conditions of general application" refer to conditions formulated in objective terms that apply horizontally to an unidentified number of economic operators and thus cover a range of situations and cases.



## Chapter 3: Specific provisions

### Article DIGIT.8 Customs duties on electronic transmissions

1. Electronic transmissions shall be considered as the supply of a service within the meaning of Title II [Services and investment] of this Heading.
2. The Parties shall not impose customs duties on electronic transmissions.

### Article DIGIT.9 No prior authorisation

1. A Party shall not require prior authorisation of the provision of a service by electronic means solely on the ground that the service is provided online, and shall not adopt or maintain any other requirement having an equivalent effect.

A service is provided online when it is provided by electronic means and without the parties being simultaneously present.

2. Paragraph 1 does not apply to telecommunications services, broadcasting services, gambling services, legal representation services or to the services of notaries or equivalent professions to the extent that they involve a direct and specific connection with the exercise of public authority.

### Article DIGIT.10: Conclusion of contracts by electronic means

1. Each Party shall ensure that contracts may be concluded by electronic means and that its law neither creates obstacles for the use of electronic contracts nor results in contracts being deprived of legal effect and validity solely on the ground that the contract has been made by electronic means.

2. Paragraph 1 does not apply to the following:

- (a) broadcasting services;
- (b) gambling services;
- (c) legal representation services;
- (d) the services of notaries or equivalent professions involving a direct and specific connection with the exercise of public authority;
- (e) contracts that require witnessing in person;
- (f) contracts that establish or transfer rights in real estate;
- (g) contracts requiring by law the involvement of courts, public authorities or professions exercising public authority;
- (h) contracts of suretyship granted, collateral securities furnished by persons acting for purposes outside their trade, business or profession; or
- (i) contracts governed by family law or by the law of succession.

#### Article DIGIT.11 Electronic authentication and electronic trust services

1. A Party shall not deny the legal effect and admissibility as evidence in legal proceedings of an electronic document, an electronic signature, an electronic seal or an electronic time stamp, or of data sent and received using an electronic registered delivery service, solely on the ground that it is in electronic form.
2. A Party shall not adopt or maintain measures that would:
  - (a) prohibit parties to an electronic transaction from mutually determining the appropriate electronic authentication methods for their transaction; or
  - (b) prevent parties to an electronic transaction from being able to prove to judicial and administrative authorities that the use of electronic authentication or an electronic trust service in that transaction complies with the applicable legal requirements.
3. Notwithstanding paragraph 2, a Party may require that for a particular category of transactions, the method of electronic authentication or trust service is certified by an authority accredited in accordance with its law or meets certain performance standards which shall be objective, transparent and non-discriminatory and only relate to the specific characteristics of the category of transactions concerned.

#### Article DIGIT.12: Transfer of or access to source code

1. A Party shall not require the transfer of, or access to, the source code of software owned by a natural or legal person of the other Party.
2. For greater certainty:
  - (a) the general exceptions, security exceptions and prudential carve-out referred to in Article DIGIT.4 [Exceptions] apply to measures of a Party adopted or maintained in the context of a certification procedure; and
  - (b) paragraph 1 of this Article does not apply to the voluntary transfer of, or granting of access to, source code on a commercial basis by a natural or legal person of the other Party, such as in the context of a public procurement transaction or a freely negotiated contract.
3. Nothing in this Article shall affect:
  - (a) a requirement by a court or administrative tribunal, or a requirement by a competition authority pursuant to a Party's competition law to prevent or remedy a restriction or a distortion of competition;
  - (b) a requirement by a regulatory body pursuant to a Party's laws or regulations related to the protection of public safety with regard to users online, subject to safeguards against unauthorised disclosure;
  - (c) the protection and enforcement of intellectual property rights; and
  - (d) the right of a Party to take measures in accordance with Article III of the GPA as incorporated by Article PPROC.2 [Incorporation of certain provisions of the GPA and covered procurement] of Title VI [Public procurement] of this Heading.

#### Article DIGIT.13 Online consumer trust

1. Recognising the importance of enhancing consumer trust in digital trade, each Party shall adopt or maintain measures to ensure the effective protection of consumers engaging in electronic commerce transactions, including but not limited to measures that:

- (a) proscribe fraudulent and deceptive commercial practices;
- (b) require suppliers of goods and services to act in good faith and abide by fair commercial practices, including through the prohibition of charging consumers for unsolicited goods and services;
- (c) require suppliers of goods or services to provide consumers with clear and thorough information, including when they act through intermediary service suppliers, regarding their identity and contact details, the transaction concerned, including the main characteristics of the goods or services and the full price inclusive of all applicable charges, and the applicable consumer rights (in the case of intermediary service suppliers, this includes enabling the provision of such information by the supplier of goods or services); and
- (d) grant consumers access to redress for breaches of their rights, including a right to remedies if goods or services are paid for and are not delivered or provided as agreed.

2. The Parties recognise the importance of entrusting their consumer protection agencies or other relevant bodies with adequate enforcement powers and the importance of cooperation between these agencies in order to protect consumers and enhance online consumer trust.

#### Article DIGIT.14 Unsolicited direct marketing communications

1. Each Party shall ensure that users are effectively protected against unsolicited direct marketing communications.

2. Each Party shall ensure that direct marketing communications are not sent to users who are natural persons unless they have given their consent in accordance with each Party's laws to receiving such communications.

3. Notwithstanding paragraph 2, a Party shall allow natural or legal persons who have collected, in accordance with conditions laid down in the law of that Party, the contact details of a user in the context of the supply of goods or services, to send direct marketing communications to that user for their own similar goods or services.

4. Each Party shall ensure that direct marketing communications are clearly identifiable as such, clearly disclose on whose behalf they are made and contain the necessary information to enable users to request cessation free of charge and at any moment.

5. Each Party shall provide users with access to redress against suppliers of direct marketing communications that do not comply with the measures adopted or maintained pursuant to paragraphs 1 to 4.

#### Article DIGIT.15 Open government data

1. The Parties recognise that facilitating public access to, and use of, government data contributes to stimulating economic and social development, competitiveness, productivity and innovation.
2. To the extent that a Party chooses to make government data accessible to the public, it shall endeavour to ensure, to the extent practicable, that the data:
  - (a) is in a format that allows it to be easily searched, retrieved, used, reused, and redistributed;
  - (b) is in a machine-readable and spatially-enabled format;
  - (c) contains descriptive metadata, which is as standard as possible;
  - (d) is made available via reliable, user-friendly and freely available Application Programming Interfaces;
  - (e) is regularly updated;
  - (f) is not subject to use conditions that are discriminatory or that unnecessarily restrict re-use; and
  - (g) is made available for re-use in full compliance with the Parties' respective personal data protection rules.
3. The Parties shall endeavour to cooperate to identify ways in which each Party can expand access to, and use of, government data that the Party has made public, with a view to enhancing and generating business opportunities, beyond its use by the public sector.

#### Article DIGIT.16 Cooperation on regulatory issues with regard to digital trade

1. The Parties shall exchange information on regulatory matters in the context of digital trade, which shall address the following:
  - (a) the recognition and facilitation of interoperable electronic trust and authentication services;
  - (b) the treatment of direct marketing communications;
  - (c) the protection of consumers; and
  - (d) any other matter relevant for the development of digital trade, including emerging technologies.
2. Paragraph 1 shall not apply to a Party's rules and safeguards for the protection of personal data and privacy, including on cross-border transfers of personal data.

#### Article DIGIT.17 - Understanding on computer services

1. The Parties agree that, for the purpose of liberalising trade in services and investment in accordance with Title II [Services and Investment] of this Heading, the following services shall be considered as computer and related services, regardless of whether they are delivered via a network, including the Internet:

- (a) consulting, adaptation, strategy, analysis, planning, specification, design, development, installation, implementation, integration, testing, debugging, updating, support, technical assistance or management of or for computers or computer systems;
- (b) computer programmes defined as the sets of instructions required to make computers work and communicate (in and of themselves), as well as consulting, strategy, analysis, planning, specification, design, development, installation, implementation, integration, testing, debugging, updating, adaptation, maintenance, support, technical assistance, management or use of or for computer programmes;
- (c) data processing, data storage, data hosting or database services;
- (d) maintenance and repair services for office machinery and equipment, including computers; and
- (e) training services for staff of clients, related to computer programmes, computers or computer systems, and not elsewhere classified.

For greater certainty, services enabled by computer and related services, other than those listed in paragraph 1, shall not be regarded as computer and related services in themselves.

#### *TITLE IV: CAPITAL MOVEMENTS, PAYMENTS, TRANSFERS AND TEMPORARY SAFEGUARD MEASURES*

##### Article CAP.1: Objectives

The objective of this Title is to enable the free movement of capital and payments related to transactions liberalised under this Agreement.

##### Article CAP.2: Current account

Each Party shall allow, in freely convertible currency and in accordance with the Articles of Agreement of the International Monetary Fund, any payments and transfers with respect to transactions on the current account of the balance of payments that fall within the scope of this Agreement.

##### Article CAP.3: Capital movements

1. Each Party shall allow, with regard to transactions on the capital and financial account of the balance of payments, the free movement of capital for the purpose of liberalisation of investment and other transactions as provided for in Title II [Services and Investment] of this Heading.
2. The Parties shall consult each other in the Trade Specialised Committee on Services, Investment and Digital Trade to facilitate the movement of capital between them in order to promote trade and investment.

##### Article CAP.4: Measures affecting capital movements, payments or transfers

1. Articles CAP.2 [Current account] and CAP.3 [Capital movements] shall not be construed as preventing a Party from applying its laws and regulations relating to:
  - (a) bankruptcy, insolvency, or the protection of the rights of creditors;

- (b) issuing, trading or dealing in securities, or futures, options and other financial instruments;
- (c) financial reporting or record keeping of capital movements, payments or transfers where necessary to assist law enforcement or financial regulatory authorities;
- (d) criminal or penal offences, deceptive or fraudulent practices;
- (e) ensuring compliance with orders or judgments in judicial or administrative proceedings; or
- (f) social security, public retirement or compulsory savings schemes.

2. The laws and regulations referred to in paragraph 1 shall not be applied in an arbitrary or discriminatory manner, or otherwise constitute a disguised restriction on capital movements, payments or transfers.

#### Article CAP.5: Temporary safeguard measures

1. In exceptional circumstances of serious difficulties for the operation of the Union's economic and monetary union, or threat thereof, the Union may adopt or maintain safeguard measures with regard to capital movements, payments or transfers for a period not exceeding six months.

2. The measures referred to in paragraph 1 shall be limited to the extent that is strictly necessary.

#### Article CAP.6: Restrictions in case of balance of payments and external financing difficulties

1. If a Party experiences serious balance of payments or external financial difficulties, or threat thereof, it may adopt or maintain restrictive measures with regard to capital movements, payments or transfers<sup>35</sup>.

2. The measures referred to in paragraph 1 shall:

- (a) be consistent with the Articles of Agreement of the International Monetary Fund;
- (b) not exceed those necessary to deal with the circumstances described in paragraph 1;
- (c) be temporary and be phased out progressively as the situation specified in paragraph 1 improves;
- (d) avoid unnecessary damage to the commercial, economic and financial interests of the other Party; and
- (e) be non-discriminatory as compared with third countries in like situations.

3. In the case of trade in goods, each Party may adopt or maintain restrictive measures in order to safeguard its external financial position or balance of payments. Those measures shall be in accordance with GATT 1994 and the Understanding on the Balance of Payments provisions of the General Agreement on Tariffs and Trade 1994.

---

<sup>35</sup> For greater certainty, serious balance of payments or external financial difficulties, or threat thereof, may be caused among other factors by serious difficulties related to monetary or exchange rate policies, or threat thereof.

4. In the case of trade in services, each Party may adopt or maintain restrictive measures in order to safeguard its external financial position or balance of payments. Those measures shall be in accordance with Article XII of GATS.

5. A Party maintaining or having adopted measures referred to in paragraphs 1 and 2 shall promptly notify them to the other Party.

6. If a Party adopts or maintains restrictions under this Article, the Parties shall promptly hold consultations in the Trade Specialised Committee on Services, Investment and Digital Trade unless consultations are held in other fora. That Committee shall assess the balance of payments or external financial difficulty that led to the respective measures, taking into account factors such as:

- (a) the nature and extent of the difficulties;
- (b) the external economic and trading environment; and
- (c) alternative corrective measures which may be available.

7. The consultations under paragraph 6 shall address the compliance of any restrictive measures with paragraphs 1 and 2. All relevant findings of a statistical or factual nature presented by the International Monetary Fund, where available, shall be accepted and conclusions shall take into account the assessment by the International Monetary Fund of the balance of payments and the external financial situation of the Party concerned.

## *TITLE V: INTELLECTUAL PROPERTY*

### Chapter 1: General provisions

#### Article IP.1: Objectives

The objectives of this Title are to:

- (a) facilitate the production, provision and commercialisation of innovative and creative products and services between the Parties by reducing distortions and impediments to such trade, thereby contributing to a more sustainable and inclusive economy; and
- (b) ensure an adequate and effective level of protection and enforcement of intellectual property rights.

#### Article IP.2: Scope

1. This Title shall complement and further specify the rights and obligations of each Party under the TRIPS Agreement and other international treaties in the field of intellectual property to which they are parties.

2. This Title does not preclude either Party from introducing more extensive protection and enforcement of intellectual property rights than required under this Title, provided that such protection and enforcement does not contravene this Title.

#### Article IP.3: Definitions

For the purposes of this Title, the following definitions apply:

- (a) "Paris Convention" means the Paris Convention for the Protection of Industrial Property of 20 March 1883, as last revised at Stockholm on 14 July 1967;
- (b) "Berne Convention" means the Berne Convention for the Protection of Literary and Artistic Works of 9 September 1886 revised at Paris on 24 July 1971 and amended on 28 September 1979;
- (c) "Rome Convention" means the International Convention for the Protection of Performers, Producers of Phonograms and Broadcasting Organisations done at Rome on 26 October 1961;
- (d) "WIPO" means the World Intellectual Property Organisation;
- (e) "intellectual property rights" means all categories of intellectual property that are covered by Articles IP.7 [Authors] to IP.37 [Protection of plant varieties rights] of this Title or Sections 1 to 7 of Part II of the TRIPS Agreement. The protection of intellectual property includes protection against unfair competition as referred to in Article 10*bis* of the Paris Convention;
- (f) "national" means, in respect of the relevant intellectual property right, a person of a Party that would meet the criteria for eligibility for protection provided for in the TRIPS Agreement and multilateral agreements concluded and administered under the auspices of WIPO, to which a Party is a contracting party.

#### Article IP.4: International agreements

1. The Parties affirm their commitment to comply with the international agreements to which they are party:

- (a) the TRIPS Agreement;
- (b) the Rome Convention;
- (c) the Berne Convention;
- (d) the WIPO Copyright Treaty, adopted at Geneva on 20 December 1996;
- (e) the WIPO Performances and Phonograms Treaty, adopted at Geneva on 20 December 1996;
- (f) the Protocol Relating to the Madrid Agreement Concerning the International Registration of Marks, adopted at Madrid on 27 June 1989, as last amended on 12 November 2007;
- (g) the Trademark Law Treaty, adopted at Geneva on 27 October 1994;
- (h) the Marrakesh Treaty to Facilitate Access to Published Works for Persons Who Are Blind, Visually Impaired or Otherwise Print Disabled, adopted at Marrakesh on 27 June 2013;
- (i) the Geneva Act of the Hague Agreement Concerning the International Registration of Industrial Designs, adopted at Geneva on 2 July 1999.

2. Each Party shall make all reasonable efforts to ratify or accede to the following international agreements:

- (a) the Beijing Treaty on Audiovisual Performances, adopted at Beijing on 24 June 2012;



- (b) the Singapore Treaty on the Law of Trademarks adopted at Singapore on 27 March 2006.

#### Article IP.5: Exhaustion

This Title does not affect the freedom of the parties to determine whether and under what conditions the exhaustion of intellectual property rights applies.

#### Article IP.6: National treatment

1. In respect of all categories of intellectual property covered by this Title, each Party shall accord to the nationals of the other Party treatment no less favourable than the treatment it accords to its own nationals with regard to the protection of intellectual property subject where applicable to the exceptions already provided for in, respectively, the Paris Convention, the Berne Convention, the Rome Convention and the Treaty on Intellectual Property in Respect of Integrated Circuits, done at Washington on 26 May 1989. In respect of performers, producers of phonograms and broadcasting organisations, this obligation only applies in respect of the rights provided for under this Agreement.

2. For the purposes of paragraph 1 of this Article, "protection" shall include matters affecting the availability, acquisition, scope, maintenance, and enforcement of intellectual property rights as well as matters affecting the use of intellectual property rights specifically addressed in this Title, including measures to prevent the circumvention of effective technological measures as referred to in Article IP.16 [Protection of technological measures] and measures concerning rights management information as referred to in Article IP.17 [Obligations concerning rights management information].

3. A Party may avail itself of the exceptions permitted pursuant to paragraph 1 in relation to its judicial and administrative procedures, including requiring a national of the other Party to designate an address for service in its territory, or to appoint an agent in its territory, if such exceptions are:

- (a) necessary to secure compliance with the Party's laws or regulations which are not inconsistent with this Title; or
- (b) not applied in a manner which would constitute a disguised restriction on trade.

4. Paragraph 1 does not apply to procedures provided in multilateral agreements concluded under the auspices of WIPO relating to the acquisition or maintenance of intellectual property rights.

### Chapter 2: Standards concerning intellectual property rights

#### *Section 1: Copyright and related rights*

#### Article IP.7: Authors

Each Party shall provide authors with the exclusive right to authorise or prohibit:

- (a) direct or indirect, temporary or permanent reproduction by any means and in any form, in whole or in part, of their works;
- (b) any form of distribution to the public by sale or otherwise of the original of their works or of copies thereof;

- (c) any communication to the public of their works by wire or wireless means, including the making available to the public of their works in such a way that members of the public may access them from a place and at a time individually chosen by them;
- (d) the commercial rental to the public of originals or copies of their works; each Party may provide that this point does not apply to buildings or works of applied art.

#### Article IP.8: Performers

Each Party shall provide performers with the exclusive right to authorise or prohibit:

- (a) the fixation of their performances;
- (b) the direct or indirect, temporary or permanent reproduction by any means and in any form, in whole or in part, of fixations of their performances;
- (c) the distribution to the public, by sale or otherwise, of the fixations of their performances;
- (d) the making available to the public of fixations of their performances, by wire or wireless means, in such a way that members of the public may access them from a place and at a time individually chosen by them;
- (e) the broadcasting by wireless means and the communication to the public of their performances, except where the performance is itself already a broadcast performance or is made from a fixation;
- (f) the commercial rental to the public of the fixation of their performances.

#### Article IP.9: Producers of phonograms

Each Party shall provide phonogram producers with the exclusive right to authorise or prohibit:

- (a) the direct or indirect, temporary or permanent, reproduction by any means and in any form, in whole or in part, of their phonograms;
- (b) the distribution to the public, by sale or otherwise, of their phonograms, including copies thereof;
- (c) the making available to the public of their phonograms, by wire or wireless means, in such a way that members of the public may access them from a place and at a time individually chosen by them;
- (d) the commercial rental of their phonograms to the public.

#### Article IP.10: Broadcasting organisations

Each Party shall provide broadcasting organisations with the exclusive right to authorise or prohibit:

- (a) the fixation of their broadcasts, whether these broadcasts are transmitted by wire or over the air, including by cable or satellite;

- (b) the direct or indirect, temporary or permanent reproduction by any means and in any form, in whole or in part, of fixations of their broadcasts, whether those broadcasts are transmitted by wire or over the air, including by cable or satellite;
- (c) the making available to the public, by wire or wireless means, of fixations of their broadcasts, whether those broadcasts are transmitted by wire or over the air, including by cable or satellite, in such a way that members of the public may access them from a place and at a time individually chosen by them;
- (d) the distribution to the public, by sale or otherwise, of fixations, including copies thereof, of their broadcasts, whether these broadcasts are transmitted by wire or over the air, including by cable or satellite;
- (e) the rebroadcasting of their broadcasts by wireless means, as well as the communication to the public of their broadcasts if such communication is made in places accessible to the public against payment of an entrance fee.

Article IP.11: Broadcasting and communication to the public of phonograms published for commercial purposes

1. Each Party shall provide a right in order to ensure that a single equitable remuneration is paid by the user to the performers and producers of phonograms, if a phonogram published for commercial purposes, or a reproduction of such phonogram, is used for broadcasting or any communication to the public.
2. Each Party shall ensure that the single equitable remuneration is shared between the relevant performers and phonogram producers. Each Party may enact legislation that, in the absence of an agreement between performers and producers of phonograms, sets the terms according to which performers and producers of phonograms shall share the single equitable remuneration.
3. Each Party may grant more extensive rights, as regards the broadcasting and communication to the public of phonograms published for commercial purposes, to performers and producers of phonograms.

Article IP.12: Term of protection

1. The rights of an author of a work shall run for the life of the author and for 70 years after the author's death, irrespective of the date when the work is lawfully made available to the public.
2. For the purpose of implementing paragraph 1, each Party may provide for specific rules on the calculation of the term of protection of musical composition with words, works of joint authorship as well as cinematographic or audiovisual works. Each Party may provide for specific rules on the calculation of the term of protection of anonymous or pseudonymous works.
3. The rights of broadcasting organisations shall expire 50 years after the first transmission of a broadcast, whether this broadcast is transmitted by wire or over the air, including by cable or satellite.
4. The rights of performers for their performances otherwise than in phonograms shall expire 50 years after the date of the fixation of the performance or, if lawfully published or lawfully

communicated to the public during this time, 50 years from the first such publication or communication to the public, whichever is the earlier.

5. The rights of performers for their performances fixed in phonograms shall expire 50 years after the date of fixation of the performance or, if lawfully published or lawfully communicated to the public during this time, 70 years from such act, whichever is the earlier.

6. The rights of producers of phonograms shall expire 50 years after the fixation is made or, if lawfully published to the public during this time, 70 years from such publication. In the absence of a lawful publication, if the phonogram has been lawfully communicated to the public during this time, the term of protection shall be 70 years from such act of communication. Each Party may provide for effective measures in order to ensure that the profit generated during the 20 years of protection beyond 50 years is shared fairly between the performers and the producers of phonograms.

7. The terms laid down in this Article shall be counted from the first of January of the year following the year of the event which gives rise to them.

8. Each Party may provide for longer terms of protection than those provided for in this Article.

#### Article IP.13: Resale right

1. Each Party shall provide, for the benefit of the author of an original work of graphic or plastic art, a resale right, to be defined as an inalienable right, which cannot be waived, even in advance, to receive a royalty based on the sale price obtained for any resale of the work, subsequent to the first transfer of the work by the author.

2. The right referred to in paragraph 1 shall apply to all acts of resale involving as sellers, buyers or intermediaries art market professionals, such as salesrooms, art galleries and, in general, any dealers in works of art.

3. Each Party may provide that the right referred to in paragraph 1 shall not apply to acts of resale, where the seller has acquired the work directly from the author less than three years before that resale and where the resale price does not exceed a certain minimum amount.

4. The procedure for collection of the remuneration and their amounts shall be determined by the law of each Party.

#### Article IP.14: Collective management of rights

1. The Parties shall promote cooperation between their respective collective management organisations for the purpose of fostering the availability of works and other protected subject matter in their respective territories and the transfer of rights revenue between the respective collective management organisations for the use of such works or other protected subject matter.

2. The Parties shall promote the transparency of collective management organisations, in particular regarding the rights revenue they collect, the deductions they apply to the rights revenue they collect, the use of the rights revenue collected, the distribution policy and their repertoire.

3. The Parties shall endeavour to facilitate arrangements between their respective collective management organisations on non-discriminatory treatment of right holders whose rights these organisations manage under representation agreements.

4. The Parties shall cooperate to support the collective management organisations established in their territory and representing another collective management organisation established in the territory of the other Party by way of a representation agreement with a view to ensuring that they accurately, regularly and diligently pay amounts owed to the represented collective management organisations and provide the represented collective management organisation with the information on the amount of rights revenue collected on its behalf and any deductions made to that rights revenue.

#### Article IP.15 Exceptions and limitations

Each Party shall confine limitations or exceptions to the rights set out in Articles IP.7 [Authors] to IP.11 Article [Broadcasting and communication to the public of phonograms published for commercial purposes] to certain special cases which do not conflict with a normal exploitation of the work or other subject-matter and do not unreasonably prejudice the legitimate interests of the right holders.

#### Article IP.16: Protection of technological measures

1. Each Party shall provide adequate legal protection against the circumvention of any effective technological measures, which the person concerned carries out in the knowledge, or with reasonable grounds to know, that he or she is pursuing that objective. Each Party may provide for a specific regime for legal protection of technological measures used to protect computer programs.

2. Each Party shall provide adequate legal protection against the manufacture, import, distribution, sale, rental, advertisement for sale or rental, or possession for commercial purposes of devices, products or components or the provision of services which:

- (a) are promoted, advertised or marketed for the purpose of circumvention of;
- (b) have only a limited commercially significant purpose or use other than to circumvent; or
- (c) are primarily designed, produced, adapted or performed for the purpose of enabling or facilitating the circumvention of, any effective technological measures.

3. For the purposes of this Section, the expression "technological measures" means any technology, device or component that, in the normal course of its operation, is designed to prevent or restrict acts, in respect of works or other subject-matter, which are not authorised by the right holder of any copyright or related right covered by this Section. Technological measures shall be deemed "effective" where the use of a protected work or other subject matter is controlled by the right holders through application of an access control or protection process, such as encryption, scrambling or other transformation of the work or other subject-matter or a copy control mechanism, which achieves the protection objective.

4. Notwithstanding the legal protection provided for in paragraph 1 of this Article, each Party may take appropriate measures, as necessary, to ensure that the adequate legal protection against the circumvention of effective technological measures provided for in accordance with this Article does not prevent beneficiaries of exceptions or limitations provided for in accordance with Article IP.15 [Exceptions and limitations] from enjoying such exceptions or limitations.

#### Article IP.17: Obligations concerning rights management information

1. Each Party shall provide adequate legal protection against any person knowingly performing without authority any of the following acts:

- (a) the removal or alteration of any electronic rights-management information;
- (b) the distribution, importation for distribution, broadcasting, communication or making available to the public of works or other subject-matter protected pursuant to this Section from which electronic rights-management information has been removed or altered without authority;

if such person knows, or has reasonable grounds to know, that by so doing he or she is inducing, enabling, facilitating or concealing an infringement of any copyright or any related rights as provided by the law of a Party.

2. For the purposes of this Article, "rights-management information" means any information provided by right holders which identifies the work or other subject-matter referred to in this Article, the author or any other right holder, or information about the terms and conditions of use of the work or other subject-matter, and any numbers or codes that represent such information.

3. Paragraph 2 applies if any of these items of information is associated with a copy of, or appears in connection with the communication to the public of, a work or other subject-matter referred to in this Article.

#### *Section 2: Trade marks*

##### Article IP.18: Trade mark classification

Each Party shall maintain a trade mark classification system that is consistent with the Nice Agreement Concerning the International Classification of Goods and Services for the Purposes of the Registration of Marks of 15 June 1957, as amended and revised.

##### Article IP.19: Signs of which a trade mark may consist

A trade mark may consist of any signs, in particular words, including personal names, or designs, letters, numerals, colours, the shape of goods or of the packaging of goods, or sounds, provided that such signs are capable of:

- (a) distinguishing the goods or services of one undertaking from those of other undertakings; and
- (b) being represented on the respective trade mark register of each Party, in a manner which enables the competent authorities and the public to determine the clear and precise subject matter of the protection afforded to its proprietor.

##### Article IP.20: Rights conferred by a trade mark

1. Each Party shall provide that the registration of a trade mark confers on the proprietor exclusive rights therein. The proprietor shall be entitled to prevent all third parties not having the proprietor's consent from using in the course of trade:

- (a) any sign which is identical with the registered trade mark in relation to goods or services which are identical with those for which the trade mark is registered;
- (b) any sign where, because of its identity with, or similarity to, the registered trade mark and the identity or similarity of the goods or services covered by this trade mark and the sign, there exists a likelihood of confusion on the part of the public, including the likelihood of association between the sign and the registered trade mark.

2. The proprietor of a registered trade mark shall be entitled to prevent all third parties from bringing goods, in the course of trade, into the Party where the trade mark is registered without being released for free circulation there, where such goods, including packaging, come from other countries or the other Party and bear without authorisation a trade mark which is identical to the trade mark registered in respect of such goods, or which cannot be distinguished in its essential aspects from that trade mark.

3. The entitlement of the proprietor of a trade mark pursuant to paragraph 2 shall lapse if during the proceedings to determine whether the registered trade mark has been infringed, evidence is provided by the declarant or the holder of the goods that the proprietor of the registered trade mark is not entitled to prohibit the placing of the goods on the market in the country of final destination.

#### Article IP.21: Registration procedure

1. Each Party shall provide for a system for the registration of trade marks in which each final negative decision taken by the relevant trade mark administration, including partial refusals of registration, shall be communicated in writing to the relevant party, duly reasoned and subject to appeal.

2. Each Party shall provide for the possibility for third parties to oppose trade mark applications or, where appropriate, trade mark registrations. Such opposition proceedings shall be adversarial.

3. Each Party shall provide a publicly available electronic database of trade mark applications and trade mark registrations.

4. Each Party shall make best efforts to provide a system for the electronic application for and processing, registration and maintenance of trade marks.

#### Article IP.22: Well-known trade marks

For the purpose of giving effect to protection of well-known trade marks, as referred to in Article 6*bis* of the Paris Convention and Article 16(2) and (3) of the TRIPS Agreement, each Party shall apply the Joint Recommendation Concerning Provisions on the Protection of Well-Known Marks, adopted by the Assembly of the Paris Union for the Protection of Industrial Property and the General Assembly of the WIPO at the Thirty-Fourth Series of Meetings of the Assemblies of the Member States of WIPO on 20 to 29 September 1999.

#### Article IP.23: Exceptions to the rights conferred by a trade mark

1. Each Party shall provide for limited exceptions to the rights conferred by a trade mark such as the fair use of descriptive terms including geographical indications, and may provide other limited exceptions, provided such exceptions take account of the legitimate interests of the proprietor of the trade mark and of third parties.

2. The trade mark shall not entitle the proprietor to prohibit a third party from using, in the course of trade:

- (a) the name or address of the third party, where the third party is a natural person;
- (b) signs or indications concerning the kind, quality, quantity, intended purpose, value, geographical origin, the time of production of goods or of rendering of the service, or other characteristics of goods or services; or
- (c) the trade mark for the purpose of identifying or referring to goods or services as those of the proprietor of that trade mark, in particular where the use of that trade mark is necessary to indicate the intended purpose of a product or service, in particular as accessories or spare parts,

provided the third party uses them in accordance with honest practices in industrial or commercial matters.

3. The trade mark shall not entitle the proprietor to prohibit a third party from using, in the course of trade, an earlier right which only applies in a particular locality if that right is recognised by the laws of the Party in question and is used within the limits of the territory in which it is recognised.

#### Article IP.24: Grounds for revocation

1. Each Party shall provide that a trade mark shall be liable to revocation if, within a continuous period of five years it has not been put to genuine use in the relevant territory of a Party by the proprietor or with the proprietor's consent in relation to the goods or services for which it is registered, and there are no proper reasons for non-use.

2. Each Party shall also provide that a trade mark shall be liable to revocation if within the period of five years following the date of completion of the registration procedure it has not been put to genuine use in the relevant territory by the proprietor or with the proprietor's consent, in relation to the goods or services for which it is registered, and there are no proper reasons for non-use.

3. However, no person may claim that the proprietor's rights in a trade mark should be revoked where, during the interval between expiry of the five-year period and filing of the application for revocation, genuine use of the trade mark has been started or resumed. The commencement or resumption of use within a period of three months preceding the filing of the application for revocation which began at the earliest on expiry of the continuous period of five years of non-use, shall, however, be disregarded where preparations for the commencement or resumption occur only after the proprietor becomes aware that the application for revocation may be filed.

4. A trade mark shall also be liable to revocation if, after the date on which it was registered:

- (a) as a consequence of acts or inactivity of the proprietor, it has become the common name in the trade for a good or service in respect of which it is registered;
- (b) as a consequence of the use made of the trade mark by the proprietor of the trade mark or with the proprietor's consent in respect of the goods or services for which it is registered, it is



liable to mislead the public, particularly as to the nature, quality or geographical origin of those goods or services.

Article IP.25: The right to prohibit preparatory acts in relation to the use of packaging or other means

Where the risk exists that the packaging, labels, tags, security or authenticity features or devices, or any other means to which the trade mark is affixed could be used in relation to goods or services and that use would constitute an infringement of the rights of the proprietor of the trade mark, the proprietor of that trade mark shall have the right to prohibit the following acts if carried out in the course of trade:

- (a) affixing a sign identical with, or similar to, the trade mark on packaging, labels, tags, security or authenticity features or devices, or any other means to which the mark may be affixed; or
- (b) offering or placing on the market, or stocking for those purposes, or importing or exporting, packaging, labels, tags, security or authenticity features or devices, or any other means to which the mark is affixed.

Article IP.26: Bad faith applications

A trade mark shall be liable to be declared invalid where the application for registration of the trade mark was made in bad faith by the applicant. Each Party may provide that such a trade mark shall not be registered.

*Section 3: Design*

Article IP.27: Protection of registered designs

1. Each Party shall provide for the protection of independently created designs that are new and original. This protection shall be provided by registration and shall confer exclusive rights upon their holders in accordance with this Section.

For the purposes of this Article, a Party may consider that a design having individual character is original.

2. The holder of a registered design shall have the right to prevent third parties not having the holder's consent at least from making, offering for sale, selling, importing, exporting, stocking the product bearing and embodying the protected design or using articles bearing or embodying the protected design where such acts are undertaken for commercial purposes.

3. A design applied to or incorporated in a product which constitutes a component part of a complex product shall only be considered to be new and original:

- (a) if the component part, once it has been incorporated into the complex product, remains visible during normal use of the latter; and
- (b) to the extent that those visible features of the component part fulfil in themselves the requirements as to novelty and originality.

4. For the purposes of point (a) of paragraph 3, "normal use" means use by the end user, excluding maintenance, servicing or repair work.

#### Article IP.28: Duration of protection

The duration of protection available for registered designs, including renewals of registered designs, shall amount to a total term of 25 years from the date on which the application was filed<sup>36</sup>.

#### Article IP.29: Protection of unregistered designs

1. Each Party shall confer on holders of an unregistered design the right to prevent the use of the unregistered design by any third party not having the holder's consent only if the contested use results from copying the unregistered design in their respective territory<sup>37</sup>. Such use shall at least cover the offering for sale, putting on the market, importing or exporting the product.
2. The duration of protection available for the unregistered design shall amount to at least three years as from the date on which the design was first made available to the public in the territory of the respective Party.

#### Article IP.30: Exceptions and exclusions

1. Each Party may provide limited exceptions to the protection of designs, including unregistered designs, provided that such exceptions do not unreasonably conflict with the normal exploitation of designs, and do not unreasonably prejudice the legitimate interests of the holder of the design, taking account of the legitimate interests of third parties.
2. Protection shall not extend to designs solely dictated by technical or functional considerations. A design shall not subsist in features of appearance of a product which must necessarily be reproduced in their exact form and dimensions in order to permit the product in which the design is incorporated or to which it is applied to be mechanically connected to or placed in, around or against another product so that either product may perform its function.
3. By way of derogation from paragraph 2, a design shall, in accordance with the conditions set out in Article IP.27(1) [Protection of registered designs], subsist in a design, which has the purpose of allowing the multiple assembly or connection of mutually interchangeable products within a modular system.

#### Article IP.31: Relationship to copyright

Each Party shall ensure that designs, including unregistered designs, shall also be eligible for protection under the copyright law of that Party as from the date on which the design was created or fixed in any form. The extent to which, and the conditions under which, such a protection is conferred, including the level of originality required, shall be determined by each Party.

#### *Section 4: Patents*

---

<sup>36</sup> Each Party may determine the relevant date of filing of the application in accordance with its own legislation.

<sup>37</sup> This section does not apply to the protection known in the United Kingdom as a design right.

#### Article IP.32: Patents and public health

1. The Parties recognise the importance of the Declaration on the TRIPS Agreement and Public Health, adopted on 14 November 2001 by the Ministerial Conference of the WTO at Doha (the "Doha Declaration"). In interpreting and implementing the rights and obligations under this Section, each Party shall ensure consistency with the Doha Declaration.
2. Each Party shall implement Article 31*bis* of the TRIPS Agreement, as well as the Annex to the TRIPS Agreement and the Appendix to the Annex to the TRIPS Agreement.

#### Article IP.33: Extension of the period of protection conferred by a patent on medicinal products and on plant protection products

1. The Parties recognise that medicinal products and plant protection products<sup>38</sup> protected by a patent in their respective territory may be subject to an administrative authorisation procedure before being put on their respective markets. The Parties recognise that the period that elapses between the filing of the application for a patent and the first authorisation to place the product on the market, as defined for that purpose by the relevant legislation, may shorten the period of effective protection under the patent.
2. Each Party shall provide for further protection, in accordance with its laws and regulations, for a product which is protected by a patent and which has been subject to an administrative authorisation procedure referred to in paragraph 1 to compensate the holder of a patent for the reduction of effective patent protection. The terms and conditions for the provision of such further protection, including its length, shall be determined in accordance with the laws and regulations of the Parties.
3. For the purposes of this Title, "medicinal product" means:
  - (a) any substance or combination of substances presented as having properties for treating or preventing disease in human beings or animals; or
  - (b) any substance or combination of substances which may be used in or administered to human beings or animals either with a view to restoring, correcting or modifying physiological functions by exerting a pharmacological, immunological or metabolic action, or to making a medical diagnosis.

#### *Section 5: Protection of undisclosed information*

#### Article IP.34: Protection of trade secrets

1. Each Party shall provide for appropriate civil judicial procedures and remedies for any trade secret holder to prevent, and obtain redress for, the acquisition, use or disclosure of a trade secret whenever carried out in a manner contrary to honest commercial practices.
2. For the purposes of this Section:
  - (a) "trade secret" means information which meets all of the following requirements:

---

<sup>38</sup> For the purposes of this Title, the term "plant protection product" shall be defined for each Party by the respective legislations of the Parties.

- (i) it is secret in the sense that it is not, as a body or in the precise configuration and assembly of its components, generally known among or readily accessible to persons within the circles that normally deal with the kind of information in question;
  - (ii) it has commercial value because it is secret; and
  - (iii) it has been subject to reasonable steps under the circumstances, by the person lawfully in control of the information, to keep it secret;
- (b) "trade secret holder" means any natural or legal person lawfully controlling a trade secret.

3. For the purposes of this Section, at least the following conduct shall be considered contrary to honest commercial practices:

- (a) the acquisition of a trade secret without the consent of the trade secret holder, whenever obtained by unauthorised access to, or by appropriation or copying of, any documents, objects, materials, substances or electronic files that are lawfully under the control of the trade secret holder, and that contain the trade secret or from which the trade secret can be deduced;
- (b) the use or disclosure of a trade secret whenever it is carried out, without the consent of the trade secret holder, by a person who is found to meet any of the following conditions:
  - (i) having acquired the trade secret in a manner referred to in point (a);
  - (ii) being in breach of a confidentiality agreement or any other duty not to disclose the trade secret; or
  - (iii) being in breach of a contractual or any other duty to limit the use of the trade secret;
- (c) the acquisition, use or disclosure of a trade secret whenever carried out by a person who, at the time of the acquisition, use or disclosure, knew, or ought to have known, under the circumstances that the trade secret had been obtained directly or indirectly from another person who was using or disclosing the trade secret unlawfully within the meaning of point (b).

4. Nothing in this Section shall be understood as requiring either Party to consider any of the following conducts as contrary to honest commercial practices:

- (a) independent discovery or creation;
- (b) the reverse engineering of a product that has been made available to the public or that is lawfully in the possession of the acquirer of the information, where the acquirer of the information is free from any legally valid duty to limit the acquisition of the trade secret;
- (c) the acquisition, use or disclosure of a trade secret required or allowed by the law of each Party;
- (d) the exercise of the right of workers or workers' representatives to information and consultation in accordance with the laws and regulations of that Party.

5. Nothing in this Section shall be understood as affecting the exercise of freedom of expression and information, including the freedom and pluralism of the media, as protected in each Party, restricting the mobility of employees, or as affecting the autonomy of social partners and their right to enter into collective agreements, in accordance with the laws and regulations of the Parties.

Article IP.35: Protection of data submitted to obtain an authorisation to put a medicinal product on the market

1. Each Party shall protect commercially confidential information submitted to obtain an authorisation to place medicinal products on the market ("marketing authorisation") against disclosure to third parties, unless steps are taken to ensure that the data are protected against unfair commercial use or except where the disclosure is necessary for an overriding public interest.

2. Each Party shall ensure that for a limited period of time to be determined by its domestic law and in accordance with any conditions set out in its domestic law, the authority responsible for the granting of a marketing authorisation does not accept any subsequent application for a marketing authorisation that relies on the results of pre-clinical tests or clinical trials submitted in the application to that authority for the first marketing authorisation, without the explicit consent of the holder of the first marketing authorisation, unless international agreements to which the Parties are both party provide otherwise.

3. Each Party shall also ensure that, for a limited period of time to be determined by its domestic law and in accordance with any conditions set out in its domestic law, a medicinal product subsequently authorised by that authority on the basis of the results of the pre-clinical tests and clinical trials referred to in paragraph 2 is not placed on the market without the explicit consent of the holder of the first marketing authorisation, unless international agreements to which the Parties are both party provide otherwise.

4. This Article is without prejudice to additional periods of protection which each Party may provide in that Party's law.

Article IP.36: Protection of data submitted to obtain marketing authorisation for plant protection products or biocidal products

1. Each Party shall recognise a temporary right of the owner of a test or study report submitted for the first time to obtain a marketing authorisation concerning safety and efficacy of an active substance, plant protection product or biocidal product. During such period, the test or study report shall not be used for the benefit of any other person who seeks to obtain a marketing authorisation for an active substance, plant protection product or biocidal product, unless the explicit consent of the first owner has been proved. For the purposes of this Article, that right is referred to as data protection.

2. The test or study report submitted for marketing authorisation of an active substance or plant protection product should fulfil the following conditions:

- (a) be necessary for the authorisation or for an amendment of an authorisation in order to allow the use on other crops; and
- (b) be certified as compliant with the principles of good laboratory practice or of good experimental practice.

3. The period of data protection shall be at least 10 years from the grant of the first authorisation by a relevant authority in the territory of the Party.

4. Each Party shall ensure that the public bodies responsible for the granting of a marketing authorisation will not use the information referred to in paragraphs 1 and 2 for the benefit of a subsequent applicant for any successive marketing authorisation, regardless whether or not it has been made available to the public.

5. Each Party shall establish rules to avoid duplicative testing on vertebrate animals.

#### *Section 6: Plant varieties*

##### Article IP.37: Protection of plant varieties rights

Each Party shall protect plant varieties rights in accordance with the International Convention for the Protection of New Varieties of Plants (UPOV) as lastly revised in Geneva on 19 March 1991. The Parties shall cooperate to promote and enforce these rights.

#### Chapter 3: Enforcement of intellectual property rights

##### *Section 1: General provisions*

##### Article IP.38: General obligations

1. Each Party shall provide under its respective law for the measures, procedures and remedies necessary to ensure the enforcement of intellectual property rights.

For the purposes of Sections 1, 2 and 4 of this Chapter, the term "intellectual property rights" does not include rights covered by Section 5 of Chapter 2 [Protection of undisclosed information].

2. The measures, procedures and remedies referred to in paragraph 1 shall:

- (a) be fair and equitable;
- (b) not be unnecessarily complicated or costly, or entail unreasonable time-limits or unwarranted delays;
- (c) be effective, proportionate and dissuasive;
- (d) be applied in such a manner as to avoid the creation of barriers to legitimate trade and to provide for safeguards against their abuse.

Article IP.39: Persons entitled to apply for the application of the measures, procedures and remedies

Each Party shall recognise as persons entitled to seek application of the measures, procedures and remedies referred to in Sections 2 and 4 of this Chapter:

- (a) the holders of intellectual property rights in accordance with the law of a Party;
- (b) all other persons authorised to use those rights, in particular licensees, in so far as permitted by and in accordance with the law of a Party; and

- (c) federations and associations<sup>39</sup>, in so far as permitted by and in accordance with the law of a Party.

*Section 2: Civil and administrative enforcement*

Article IP.40: Measures for preserving evidence

1. Each Party shall ensure that, even before the commencement of proceedings on the merits of the case, the competent judicial authorities may, on application by a party who has presented reasonably available evidence to support their claims that their intellectual property right has been infringed or is about to be infringed, order prompt and effective provisional measures to preserve relevant evidence in respect of the alleged infringement, subject to appropriate safeguards and the protection of confidential information.

2. Such measures may include the detailed description, with or without the taking of samples, or the physical seizure of the alleged infringing goods, and, in appropriate cases, the materials and implements used in the production and/or distribution of these goods and the documents relating thereto.

Article IP.41: Evidence

1. Each Party shall take the measures necessary to enable the competent judicial authorities to order, on application by a party which has presented reasonably available evidence sufficient to support its claims and has, in substantiating those claims, specified evidence which lies in the control of the opposing party, that this evidence be produced by the opposing party, subject to the protection of confidential information.

2. Each Party shall also take the necessary measures to enable the competent judicial authorities to order, where appropriate, in cases of infringement of an intellectual property right committed on a commercial scale, under the same conditions as in paragraph 1, the communication of banking, financial or commercial documents under the control of the opposing party, subject to the protection of confidential information.

Article IP.42: Right of information

1. Each Party shall ensure that, in the context of civil proceedings concerning an infringement of an intellectual property right and in response to a justified and proportionate request of the claimant, the competent judicial authorities may order the infringer or any other person to provide information on the origin and distribution networks of the goods or services which infringe an intellectual property right.

2. For the purposes of paragraph 1, "any other person" means a person who:

- (a) was found in possession of the infringing goods on a commercial scale;
- (b) was found to be using the infringing services on a commercial scale;

---

<sup>39</sup> For greater certainty, and in so far as permitted by the law of a Party, the term "federations and associations" includes at least collective rights management bodies and professional defence bodies which are regularly recognised as having the right to represent holders of intellectual property rights.

- (c) was found to be providing on a commercial scale services used in infringing activities; or
  - (d) was indicated by the person referred to in points (a), (b) or (c), as being involved in the production, manufacture or distribution of the goods or the provision of the services.
3. The information referred to in paragraph 1 shall, as appropriate, comprise:
- (a) the names and addresses of the producers, manufacturers, distributors, suppliers and other previous holders of the goods or services, as well as the intended wholesalers and retailers;
  - (b) information on the quantities produced, manufactured, delivered, received or ordered, as well as the price obtained for the goods or services in question.
4. Paragraphs 1 and 2 shall apply without prejudice to other laws of a Party which:
- (a) grant the right holder rights to receive fuller information;
  - (b) govern the use in civil proceedings of the information communicated pursuant to this Article;
  - (c) govern responsibility for misuse of the right of information;
  - (d) afford an opportunity for refusing to provide information which would force the person referred to in paragraph 1 to admit their own participation or that of their close relatives in an infringement of an intellectual property right;
  - (e) govern the protection of confidentiality of information sources or the processing of personal data.

#### Article IP.43: Provisional and precautionary measures

1. Each Party shall ensure that its judicial authorities may, at the request of the applicant, issue against the alleged infringer an interlocutory injunction intended to prevent any imminent infringement of an intellectual property right, or to forbid, on a provisional basis and subject, where appropriate, to a recurring penalty payment where provided for by the law of that Party, the continuation of the alleged infringements of that right, or to make such continuation subject to the lodging of guarantees intended to ensure the compensation of the right holder. An interlocutory injunction may also be issued, under the same conditions, against an intermediary whose services are being used by a third party to infringe an intellectual property right.
2. Each Party shall ensure that its judicial authorities may, at the request of the applicant, order the seizure or delivery up of goods suspected of infringing an intellectual property right, so as to prevent their entry into or movement within the channels of commerce.
3. In the case of an alleged infringement committed on a commercial scale, each Party shall ensure that, if the applicant demonstrates circumstances likely to endanger the recovery of damages, the judicial authorities may order the precautionary seizure of the movable and immovable property of the alleged infringer, including the blocking of their bank accounts and other assets. To that end, the competent authorities may order the communication of bank, financial or commercial documents, or appropriate access to the relevant information.
4. Each Party shall ensure that its judicial authorities shall, in respect of the measures referred to in paragraphs 1, 2 and 3, have the authority to require the applicant to provide any reasonably



available evidence in order to satisfy themselves with a sufficient degree of certainty that the applicant is the rightholder and that the applicant's right is being infringed, or that such infringement is imminent.

#### Article IP.44: Corrective measures

1. Each Party shall ensure that its judicial authorities may order, at the request of the applicant, without prejudice to any damages due to the right holder by reason of the infringement, and without compensation of any sort, the destruction of goods that they have found to be infringing an intellectual property right or at least the definitive removal of those goods from the channels of commerce. If appropriate, under the same conditions, the judicial authorities may also order destruction of materials and implements predominantly used in the creation or manufacture of those goods.

2. Each Party's judicial authorities shall have the authority to order that those measures shall be carried out at the expense of the infringer, unless particular reasons are invoked for not doing so.

#### Article IP.45: Injunctions

Each Party shall ensure that, where a judicial decision is taken finding an infringement of an intellectual property right, the judicial authorities may issue against the infringer an injunction aimed at prohibiting the continuation of the infringement. Each Party shall also ensure that the judicial authorities may issue an injunction against intermediaries whose services are used by a third party to infringe an intellectual property right.

#### Article IP.46: Alternative measures

Each Party may provide that the judicial authorities, in appropriate cases and at the request of the person liable to be subject to the measures provided for in Article IP.44 [Corrective measures] or Article IP.45 [Injunctions], may order pecuniary compensation to be paid to the injured party instead of applying the measures provided for in these two Articles if that person acted unintentionally and without negligence, if execution of the measures in question would cause the person disproportionate harm and if pecuniary compensation to the injured party appears reasonably satisfactory.

#### Article IP.47: Damages

1. Each Party shall ensure that its judicial authorities, on application of the injured party, order the infringer who knowingly engaged, or had reasonable grounds to know it was engaging, in an infringing activity, to pay to the rightholder damages appropriate to the actual prejudice suffered by the rightholder as a result of the infringement.

2. Each Party shall ensure that when its judicial authorities set the damages:

- (a) they take into account all appropriate aspects, such as the negative economic consequences, including lost profits, which the injured party has suffered, any unfair profits made by the infringer and, in appropriate cases, elements other than economic factors, such as the moral prejudice caused to the right holder by the infringement; or
- (b) as an alternative to point (a), they may, in appropriate cases, set the damages as a lump sum on the basis of elements such as at least the amount of royalties or fees which would have

been due if the infringer had requested authorisation to use the intellectual property right in question.

3. Where the infringer did not knowingly, or with reasonable grounds to know, engage in infringing activity, each Party may lay down that the judicial authorities may order the recovery of profits or the payment of damages which may be pre-established.

#### Article IP.48: Legal costs

Each Party shall ensure that reasonable and proportionate legal costs and other expenses incurred by the successful party shall, as a general rule, be borne by the unsuccessful party, unless equity does not allow this.

#### Article IP.49: Publication of judicial decisions

Each Party shall ensure that, in legal proceedings instituted for infringement of an intellectual property right, the judicial authorities may order, at the request of the applicant and at the expense of the infringer, appropriate measures for the dissemination of the information concerning the decision, including displaying the decision and publishing it in full or in part.

#### Article IP.50: Presumption of authorship or ownership

For the purposes of applying the measures, procedures and remedies provided for in Chapter 3 [Enforcement of intellectual property rights]:

- (a) for the author of a literary or artistic work, in the absence of proof to the contrary, to be regarded as such, and consequently to be entitled to institute infringement proceedings, it shall be sufficient for the author's name to appear on the work in the usual manner; and
- (b) point (a) applies *mutatis mutandis* to the holders of rights related to copyright with regard to their protected subject matter.

#### Article IP.51: Administrative procedures

To the extent that any civil remedy can be ordered on the merits of a case as a result of administrative procedures, such procedures shall conform to principles equivalent in substance to those set forth in this Section.

#### *Section 3: Civil judicial procedures and remedies of trade secrets*

#### Article IP.52: Civil judicial procedures and remedies of trade secrets

1. Each Party shall ensure that any person participating in the civil judicial proceedings referred to in Article IP.34(1) [Scope of protection of trade secrets], or who has access to documents which form part of those proceedings, is not permitted to use or disclose any trade secret or alleged trade secret which the competent judicial authorities have, in response to a duly reasoned application by an interested party, identified as confidential and of which they have become aware as a result of such participation or access.

2. Each Party shall ensure that the obligation referred to in paragraph 1 remains in force after the civil judicial proceedings have ended, for as long as appropriate.

3. In the civil judicial proceedings referred to Article IP.34(1) [Scope of protection of trade secrets], each Party shall provide that its judicial authorities have the authority at least to:

- (a) order provisional measures, in accordance with their respective laws and regulations, to cease and prohibit the use or disclosure of the trade secret in a manner contrary to honest commercial practices;
- (b) order measures, in accordance with their respective laws and regulations, ordering the cessation of, or as the case may be, the prohibition of the use or disclosure of the trade secret in a manner contrary to honest commercial practices;
- (c) order, in accordance with their respective laws and regulations, any person who has acquired, used or disclosed a trade secret in a manner contrary to honest commercial practices and that knew or ought to have known that he or she or it was acquiring, using or disclosing a trade secret in a manner contrary to honest commercial practices to pay the trade secret holder damages appropriate to the actual prejudice suffered as a result of such acquisition, use or disclosure of the trade secret;
- (d) take specific measures necessary to preserve the confidentiality of any trade secret or alleged trade secret used or referred to in proceedings as referred to in Article IP.34(1) [Scope of protection of trade secrets]. Such specific measures may include, in accordance with each Party's respective laws and regulations, including the rights of defence, the possibility of restricting access to certain documents in whole or in part; of restricting access to hearings and their corresponding records or transcript; and of making available a non-confidential version of judicial decision in which the passages containing trade secrets have been removed or redacted.
- (e) impose sanctions on any person participating in the legal proceedings who fail or refuse to comply with the court orders concerning the protection of the trade secret or alleged trade secret.

4. Each Party shall ensure that an application for the measure, procedures or remedies provided for in this Article is dismissed where the alleged acquisition, use or disclosure of a trade secret contrary to honest commercial practices was carried out, in accordance with its laws and regulations:

- (a) to reveal misconduct, wrongdoing or illegal activity for the purpose of protecting the general public interest;
- (b) as a disclosure by employees to their representatives as part of, and necessary for, the legitimate exercise by those representatives of their functions;
- (c) to protect a legitimate interest recognised by the laws and regulations of that Party.

#### *Section 4: Border enforcement*

## Article IP.53: Border measures

1. With respect to goods under customs control, each Party shall adopt or maintain procedures under which a right holder may submit applications to a competent authority<sup>40</sup> to suspend the release of or detain suspected goods. For the purposes of this Section, "suspected goods" means goods suspected of infringing trade marks, copyrights and related rights, geographical indications, patents, utility models, industrial designs, topographies of integrated circuits and plant variety rights.
2. Each Party shall have in place electronic systems for the management by customs of the applications granted or recorded.
3. Each Party shall ensure that its competent authorities do not charge a fee to cover the administrative costs resulting from the processing of an application or a recordation.
4. Each Party shall ensure that its competent authorities decide about granting or recording applications within a reasonable period of time.
5. Each Party shall provide for the applications referred to in paragraph 1 to apply to multiple shipments.
6. With respect to goods under customs control, each Party shall ensure that its customs authorities may act upon their own initiative to suspend the release of or detain suspected goods.
7. Each Party shall ensure that its customs authorities use risk analysis to identify suspected goods.
8. Each Party may authorise its customs authority to provide a right holder, upon request, with information about goods, including a description and the actual or estimated quantities thereof, and if known, the name and address of the consignor, importer, exporter or consignee, and the country of origin or provenance of the goods, whose release has been suspended, or which have been detained.
9. Each Party shall have in place procedures allowing for the destruction of suspected goods, without there being any need for prior administrative or judicial proceedings for the formal determination of the infringements, where the persons concerned agree or do not oppose the destruction. In case suspected goods are not destroyed, each Party shall ensure that, except in exceptional circumstances, such goods are disposed of outside the commercial channel in a manner which avoids any harm to the right holder.
10. Each Party shall have in place procedures allowing for the swift destruction of counterfeit trade mark and pirated goods sent in postal or express couriers' consignments.
11. Each Party shall provide that, where requested by the customs authorities, the holder of the granted or recorded application shall be obliged to reimburse the costs incurred by the customs authorities, or other parties acting on behalf of customs authorities, from the moment of detention or suspension of the release of the goods, including storage, handling, and any costs relating to the destruction or disposal of the goods.

---

<sup>40</sup> For the European Union the competent authority means the customs authorities.

12. Each Party may decide not to apply this Article to the import of goods put on the market in another country by or with the consent of the right holders. A Party may exclude from the application of this Article goods of a non-commercial nature contained in travellers' personal luggage.

13. Each Party shall allow its customs authorities to maintain a regular dialogue and promote cooperation with the relevant stakeholders and with other authorities involved in the enforcement of intellectual property rights.

14. The Parties shall cooperate in respect of international trade in suspected goods. In particular, the Parties shall, as far as possible, share relevant information on trade in suspected goods affecting the other Party.

15. Without prejudice to other forms of cooperation, the Protocol on mutual administrative assistance in customs matters applies with regard to breaches of legislation on intellectual property rights for the enforcement of which the customs authorities of a Party are competent in accordance with this Article.

#### Article IP.54: Consistency with GATT 1994 and the TRIPS Agreement

In implementing border measures for the enforcement of intellectual property rights by customs, whether or not covered by this Section, the Parties shall ensure consistency with their obligations under GATT 1994 and the TRIPS Agreement and, in particular, with Article V of GATT 1994 and Article 41 and Section 4 of Part III of the TRIPS Agreement.

#### Chapter 4: Other provisions

#### Article IP.55: Cooperation

1. The Parties shall cooperate with a view to supporting the implementation of the commitments and obligations undertaken under this Title.

2. The areas of cooperation include, but are not limited to, the following activities:

- (a) exchange of information on the legal framework concerning intellectual property rights and relevant rules of protection and enforcement;
- (b) exchange of experience on legislative progress, on the enforcement of intellectual property rights and on enforcement at central and sub-central level by customs, police, administrative and judiciary bodies;
- (c) coordination to prevent exports of counterfeit goods, including coordination with other countries;
- (d) technical assistance, capacity building, exchange and training of personnel;
- (e) protection and defence of intellectual property rights and the dissemination of information in this regard in, among others, to business circles and civil society;
- (f) public awareness of consumers and right holders;

- (g) the enhancement of institutional cooperation, particularly between the intellectual property offices of the Parties;
- (h) educating and promoting awareness among the general public regarding policies concerning the protection and enforcement of intellectual property rights;
- (i) the promotion of protection and enforcement of intellectual property rights with public-private collaboration involving small and medium-size enterprises;
- (j) the formulation of effective strategies to identify audiences and communication programmes to increase consumer and media awareness of the impact of intellectual property rights' violations, including the risk to health and safety and the connection to organised crime.

3. The Parties shall, either directly or through the Trade Specialised Committee on Intellectual Property, maintain contact on all matters related to the implementation and functioning of this Title.

#### Article IP.56: Voluntary stakeholder initiatives

Each Party shall endeavour to facilitate voluntary stakeholder initiatives to reduce intellectual property rights infringement, including online and in other marketplaces focusing on concrete problems and seeking practical solutions that are realistic, balanced proportionate and fair for all concerned including in the following ways:

- (a) each Party shall endeavour to convene stakeholders consensually in its territory to facilitate voluntary initiatives to find solutions and resolve differences regarding the protection and enforcement of intellectual property rights and reducing infringement;
- (b) the Parties shall endeavour to exchange information with each other regarding efforts to facilitate voluntary stakeholder initiatives in their respective territories; and
- (c) the Parties shall endeavour to promote open dialogue and cooperation among the Parties' stakeholders, and to encourage the Parties' stakeholders to jointly find solutions and resolve differences regarding the protection and enforcement of intellectual property rights and reducing infringement.

#### Article IP.57: Review in relation to geographical indications

Noting the relevant provisions of any earlier bilateral agreement between the United Kingdom of the one part and the European Union and European Atomic Energy Community of the other part, the Parties may jointly use reasonable endeavours to agree rules for the protection and effective domestic enforcement of their geographical indications.

### *TITLE VI: PUBLIC PROCUREMENT*

#### Chapter 1: Scope

##### Article PPROC.1: Objective

The objective of this Title is to guarantee each Party's suppliers access to increased opportunities to participate in public procurement procedures and to enhance the transparency of public procurement procedures.

## Article PPROC.2: Incorporation of certain provisions of the GPA and covered procurement

1. The provisions of the GPA that are specified in Section A of Annex PPROC-1, including the Annexes of each Party to Appendix I to the GPA, are hereby incorporated into this Title.
2. For the purposes of this Title, "covered procurement" means procurement to which Article II of the GPA applies and, in addition, procurement listed in Section B of Annex PPROC-1.
3. With regard to covered procurement, each Party shall apply, *mutatis mutandis*, the provisions of the GPA specified in Section A of Annex PPROC-1 to suppliers, goods or services of the other Party.

## Chapter 2: Additional rules for covered procurement

### Article PPROC.3: Use of electronic means in procurement

1. Each Party shall ensure that its procuring entities conduct covered procurement by electronic means to the widest extent practicable.
2. A procuring entity is considered as conducting covered procurement by electronic means, if the entity uses electronic means of information and communication for:
  - (a) the publication of notices and tender documentation in procurement procedures; and
  - (b) the submission of requests to participate and of tenders.
3. Except for specific situations, such electronic means of information and communication shall be non-discriminatory, generally available and interoperable with the information and communication technology products in general use and shall not restrict access to the procurement procedure.
4. Each Party shall ensure that its procuring entities receive and process electronic invoices in accordance with its legislation.

### Article PPROC.4: Electronic publication

With regard to covered procurement, all procurement notices including notices of intended procurement, summary notices, notices of planned procurement and contract award notices shall be directly accessible by electronic means, free of charge, through a single point of access on the internet.

### Article PPROC.5: Supporting evidence

Each Party shall ensure that at the time of submission of requests to participate or at the time of submission of tenders, procuring entities do not require suppliers to submit all or part of the supporting evidence that they are not in one of the situations in which a supplier may be excluded and that they fulfil the conditions for participation unless this is necessary to ensure the proper conduct of the procurement.

#### Article PPROC.6: Conditions for participation

Each Party shall ensure that where its procuring entities require a supplier, as a condition for participation in a covered procurement, to demonstrate prior experience they do not require that the supplier has such experience in the territory of that Party.

#### Article PPROC.7: Registration systems and qualification procedures

A Party that maintains a supplier registration system shall ensure that interested suppliers may request registration at any time. Any interested supplier having made a request shall be informed within a reasonable period of time of the decision to grant or reject this request.

#### Article PPROC.8: Selective tendering

Each Party shall ensure that where a procuring entity uses a selective tendering procedure, the procuring entity addresses invitations to submit a tender to a number of suppliers that is sufficient to ensure genuine competition without affecting the operational efficiency of the procurement system.

#### Article PPROC.9: Abnormally low prices

Further to paragraph 6 of Article XV of the GPA, if a procuring entity receives a tender with a price that is abnormally lower than the prices in other tenders submitted, it may also verify with the supplier whether the price takes into account the grant of subsidies.

#### Article PPROC.10: Environmental, social and labour considerations

Each Party shall ensure that its procuring entities may take into account environmental, labour and social considerations throughout the procurement procedure, provided that those considerations are compatible with the rules established by Chapters 1 and 2 and are indicated in the notice of intended procurement or in another notice used as a notice of intended procurement or tender documentation.

#### Article PPROC.11: Domestic review procedures

1. Where an impartial administrative authority is designated by a Party under paragraph 4 of Article XVIII of the GPA, that Party shall ensure that:

- (a) the members of the designated authority are independent, impartial, and free from external influence during the term of appointment;
- (b) the members of the designated authority are not dismissed against their will while they are in office, unless their dismissal is required by the provisions governing the designated authority; and
- (c) the President or at least one other member of the designated authority, has legal and professional qualifications equivalent to those necessary for judges, lawyers or other legal experts qualified under the laws and regulations of the Party.

2. Each Party shall adopt or maintain procedures that provide for rapid interim measures to preserve the supplier's opportunity to participate in the procurement. Such interim measures, provided for in subparagraph 7(a) of Article XVIII of the GPA, may result in suspension of the



procurement process or, if a contract has been concluded by the procuring entity and if a Party has so provided, in suspension of performance of the contract. The procedures may provide that overriding adverse consequences for the interests concerned, including the public interest, may be taken into account when deciding whether such measures should be applied. Just cause for not acting shall be provided in writing.

3. In case an interested or participating supplier has submitted a challenge with the designated authority referred to in paragraph 1, each Party shall, in principle, ensure that a procuring entity shall not conclude the contract until that authority has made a decision or recommendation on the challenge with regard to interim measures, corrective action or compensation for the loss or damages suffered as referred to in paragraphs 2, 5 and 6 in accordance with its rules, regulations and procedures. Each Party may provide that in unavoidable and duly justified circumstances, the contract can be nevertheless concluded.

4. Each Party may provide for:

- (a) a standstill period between the contract award decision and the conclusion of a contract in order to give sufficient time to unsuccessful suppliers to assess whether it is appropriate to initiate a review procedure; or
- (b) a sufficient period for an interested supplier to submit a challenge, which may constitute grounds for the suspension of the execution of a contract.

5. Corrective action under subparagraph 7(b) of Article XVIII of the GPA may include one or more of the following:

- (a) the removal of discriminatory technical, economic or financial specifications in the invitation to tender, the contract documents or any other document relating to the tendering procedure and conduct of new procurement procedures;
- (b) the repetition of the procurement procedure without changing the conditions;
- (c) the setting aside of the contract award decision and the adoption of a new contract award decision;
- (d) the termination of a contract or the declaration of its ineffectiveness; or
- (e) the adoption of other measures with the aim to remedy a breach of Chapters 1 and 2, for example an order to pay a particular sum until the breach has been effectively remedied.

6. In accordance with subparagraph 7(b) of Article XVIII of the GPA, each Party may provide for the award of compensation for the loss or damages suffered. In this regard, if the review body of the Party is not a court and a supplier believes that there has been a breach of the domestic laws and regulations implementing the obligations under Chapters 1 and 2, the supplier may bring the matter before a court, including with a view to seeking compensation, in accordance with judicial procedures of the Party.

7. Each Party shall adopt or maintain the necessary procedures by which the decisions or recommendations made by review bodies are effectively implemented, or the decisions by judicial review bodies are effectively enforced.

### Chapter 3: National treatment beyond covered procurement

#### Article PPROC.12: Definitions

1. For the purposes of this Chapter, the treatment accorded by a Party under this Chapter means:
  - (a) with respect to the United Kingdom, treatment no less favourable than the most favourable treatment accorded, in like situations, to suppliers of the United Kingdom; and
  - (b) with respect to a Member State, treatment no less favourable than the most favourable treatment accorded, in like situations, within that Member State to suppliers of that Member State.
2. For the purposes of this Chapter, a supplier of a Party, which is a legal person means:
  - (a) for the Union, a legal person constituted or organised under the law of the Union or at least one of its Member States and engaged in substantive business operations, understood by the Union, in line with its notification of the Treaty establishing the European Community to the WTO (WT/REG39/1), as equivalent to the concept of "effective and continuous link" with the economy of a Member State enshrined in Article 54 of the Treaty on the Functioning of the European Union, in the territory of the Union; and
  - (b) for the United Kingdom, a legal person constituted or organised under the law of the United Kingdom and engaged in substantive business operations in the territory of the United Kingdom.

#### Article PPROC.13: National treatment of locally established suppliers

1. With regard to any procurement, a measure of a Party shall not result for suppliers of the other Party established in its territory through the constitution, acquisition or maintenance of a legal person in treatment less favourable than that Party accords to its own like suppliers<sup>41</sup>.
2. The application of the national treatment obligation provided for in this Article remains subject to security and general exceptions as defined in Article III of the GPA, even if the procurement is not covered procurement in accordance with this Title.

#### Chapter 4: Other provisions

#### Article PPROC.14: Modifications and rectifications of market access commitments

Each Party may modify or rectify its market access commitments in its respective Sub-section under Section B of Annex PPROC-.1 in accordance with the procedures set out in Articles PPROC.15 [Modifications] to PPROC.18 [Amendment of Section Annex PROC-1].

#### Article PPROC.15: Modifications

1. A Party intending to modify a Sub-section under Section B of Annex PPROC-1, shall:

---

<sup>41</sup> For greater certainty, application of the national treatment obligation provided for in this Article is subject to the exceptions referred to in note 3 of the Notes of Sub-sections B1 and B2 of ANNEX PPROC-1 [Public Procurement].

- (a) notify the other Party in writing; and
- (b) include in the notification a proposal for appropriate compensatory adjustments to the other Party to maintain a level of market access commitments comparable to that existing prior to the modification.

2. Notwithstanding point (b) of paragraph 1, a Party is not required to provide compensatory adjustments to the other Party if the proposed modification covers a procuring entity over which the Party has effectively eliminated its control or influence in respect of covered procurement.

A Party's control or influence over the covered procurement of procuring entities is presumed to be effectively eliminated if the procuring entity is exposed to competition in markets to which access is not restricted.

3. The other Party may object to the modification referred to in point (a) of paragraph 1 if it disputes that:

- (a) a compensatory adjustment proposed under point (b) of paragraph 1 is adequate to maintain a comparable level of mutually agreed market access commitments; or
- (b) the modification covers a procuring entity over which the Party has effectively eliminated its control or influence as provided for in paragraph 2.

The other Party shall object in writing within 45 days of receipt of the notification referred to in point (a) of paragraph 1 or be deemed to have accepted the compensatory adjustment or modification, including for the purposes of Title I [Dispute Settlement] of Part Six [Dispute settlement and horizontal provisions].

#### Article PPROC.16: Rectifications

1. A Party intending to rectify a Sub-section under Section B of Annex PPROC-1 shall notify the other Party in writing.

The following changes to a Sub-section under Section B of Annex PPROC-1 shall be considered a rectification, provided that they do not affect the mutually agreed market access commitments provided for in this Title:

- (a) a change in the name of a procuring entity;
- (b) a merger of two or more procuring entities listed within that Sub-section; and
- (c) the separation of a procuring entity listed in that Sub-section into two or more procuring entities that are added to the procuring entities listed in the same Sub-section.

2. A Party may notify the other Party of an objection to a proposed rectification within 45 days from having received the notification. A Party submitting an objection shall set out the reasons for considering the proposed rectification not as a change provided for in paragraph 1, and describe the effect of the proposed rectification on the mutually agreed market access commitments provided for in this Title. If no such objection is submitted in writing within 45 days after having received the notification, the Party shall be deemed to have agreed to the proposed rectification.

#### Article PPROC.17: Consultations and dispute resolution

If a Party objects to the proposed modification or the proposed compensatory adjustments referred to in Article PPROC.15 [Modifications] or to the proposed rectification referred to in Article PPROC.16 [Rectifications], the Parties shall seek to resolve the issue through consultations. If no agreement is found within 60 days of receipt of the objection, the Party seeking to modify or rectify its Sub-section under Section B of Annex PPROC-1 may refer the matter to dispute settlement in accordance with Title I [Dispute settlement] of Part Six [Dispute settlement and horizontal provisions], to determine whether the objection is justified.

#### Article PPROC.18: Amendment of Section B of Annex PPROC-1

If a Party does not object to the modification pursuant to Article PPROC.15(3) [Modifications] or to a rectification pursuant to Article PPROC.16(2) [Rectifications], or the modifications or rectifications are agreed between the Parties through the consultations referred to in Article PPROC.17 [Consultations and dispute resolution], or there is a final settlement of the matter under Title I [Dispute settlement] of Part Six [Dispute settlement and horizontal provisions], the Partnership Council shall amend the relevant Sub-section under Section B of Annex PPROC-1 to reflect the corresponding modifications or rectifications or the compensatory adjustments.

#### Article PPROC.19: Cooperation

1. The Parties recognise the benefits that may arise from cooperating in the international promotion of the mutual liberalisation of public procurement markets.
2. The Parties shall make available to each other annual statistics on covered procurement subject to technical availability.

### *TITLE VII: SMALL AND MEDIUM-SIZED ENTERPRISES*

#### Article SME.1: Objective

The objective of this Title is to enhance the ability of small and medium-sized enterprises to benefit from Heading one [Trade].

#### Article SME.2: Information sharing

1. Each Party shall establish or maintain its own publicly accessible website for small and medium-sized enterprises with information regarding Heading one [Trade], including:
  - (a) a summary of Heading one [Trade];
  - (b) a description of the provisions in Heading one [Trade] that each Party considers to be relevant to small and medium-sized enterprises of both Parties; and
  - (c) any additional information that each Party considers would be useful for small and medium-sized enterprises interested in benefitting from Heading one [Trade].
2. Each Party shall include an internet link in the website provided for in paragraph 1 to the:
  - (a) text of Heading one [Trade];

- (b) equivalent website of the other Party; and
- (c) websites of its own authorities that the Party considers would provide useful information to persons interested in trading and doing business in its territory.

3. Each Party shall include an internet link in the website provided for in paragraph 1 to websites of its own authorities with information related to the following:

- (a) customs laws and regulations, procedures for importation, exportation and transit as well as relevant forms, documents and other information required;
- (b) laws, regulations and procedures concerning intellectual property rights, including geographical indications;
- (c) technical laws and regulations including, where necessary, obligatory conformity assessment procedures and links to lists of conformity assessment bodies, in cases where third party conformity assessment is obligatory, as provided for in Chapter 4 [Technical barriers to trade] of Title I [Trade in goods] of this Heading;
- (d) laws and regulations on sanitary and phytosanitary measures relating to importation and exportation as provided for in Chapter 3 [Sanitary and phytosanitary issues] of Title I [Trade in goods] of this Heading;
- (e) laws and regulations on public procurement, single point of access on the internet to public procurement notices as provided for in Title VI [Public procurement] of this Heading and other relevant provisions contained in that Title;
- (f) company registration procedures; and
- (g) other information which the Party considers may be of assistance to small and medium-sized enterprises.

4. Each Party shall include an internet link in the website provided for in paragraph 1 to a database that is electronically searchable by tariff nomenclature code and that includes the following information with respect to access to its market:

- (a) in respect of tariff measures and tariff-related information:
  - (i) rates of customs duties and quotas, including most-favoured nation, rates concerning non most-favoured nation countries and preferential rates and tariff rate quotas;
  - (ii) excise duties;
  - (iii) taxes (value added tax/ sales tax);
  - (iv) customs or other fees, including other product specific fees;
  - (v) rules of origin as provided for in Chapter 2 [Rules of origin] of Title I [Trade in Goods] of this Heading;
  - (vi) duty drawback, deferral, or other types of relief that reduce, refund, or waive customs duties;

- (vii) criteria used to determine the customs value of the good; and
    - (viii) other tariff measures;
  - (b) in respect of tariff nomenclature related non-tariff measures:
    - (i) information needed for import procedures; and
    - (ii) information related to non-tariff measures.
5. Each Party shall regularly, or if requested by the other Party, update the information and links referred to in paragraphs 1 to 4 that it maintains on its website to ensure such information and links are up-to-date and accurate.
6. Each Party shall ensure that the information and links referred to in paragraphs 1 to 4 is presented in an adequate manner to use for small and medium-sized enterprises. Each Party shall endeavour to make the information available in English.
7. No fee shall apply for access to the information provided pursuant to paragraphs 1 to 4 for any person of either Party.

#### Article SME.3: Small and medium-sized enterprises contact points

1. Upon the entry into force of this Agreement, each Party shall designate a contact point to carry out the functions listed in this Article and notify the other Party of its contact details. The Parties shall promptly notify each other of any change of those contact details.
2. The small and medium-sized enterprises contact points of the Parties shall:
  - (a) seek to ensure that the needs of small and medium-sized enterprises are taken into account in the implementation of Heading one [Trade] and that small and medium-sized enterprises of both Parties can take advantage of Heading one [Trade];
  - (b) consider ways for strengthening the cooperation on matters of relevance to small and medium-sized enterprises between the Parties in view of increasing trade and investment opportunities for small and medium-sized enterprises;
  - (c) ensure that the information referred to in Article SME.2 [Information sharing] is up-to-date, accurate and relevant for small and medium-sized enterprises. Either Party may, through the small and medium-sized enterprises contact point, suggest additional information that the other Party may include in its websites to be maintained in accordance with Article SME.2 [Information sharing];
  - (d) examine any matter relevant to small and medium-sized enterprises in connection with the implementation of Heading one [Trade], including:
    - (i) exchanging information to assist the Partnership Council in its task to monitor and implement the small and medium-sized enterprises-related aspects of Heading one [Trade];

- (ii) assisting specialised committees, joint working groups and contact points established by this Agreement in considering matters of relevance to small and medium-sized enterprises;
  - (e) report periodically on their activities, jointly or individually, to the Partnership Council for its consideration; and
  - (f) consider any other matter arising under this Agreement pertaining to small and medium-sized enterprises as the Parties may agree.
3. The small and medium-sized enterprises contact points of the Parties shall carry out their work through the communication channels decided by the Parties, which may include electronic mail, videoconferencing or other means. They may also meet, as appropriate.
4. Small and medium-sized enterprises contact points may seek to cooperate with experts and external organisations, as appropriate, in carrying out their activities.

#### Article SME.4: Relation with Part Six

Title I [Dispute settlement] of Part Six [Dispute settlement and horizontal provisions] does not apply to this Title.

### *TITLE VIII: ENERGY*

#### Chapter 1: General provisions

##### Article ENER.1: Objectives

The objectives of this Title are to facilitate trade and investment between the Parties in the areas of energy and raw materials, and to support security of supply and environmental sustainability, notably in contributing to the fight against climate change in those areas.

##### Article ENER.2: Definitions

1. For the purposes of this Title, the following definitions apply:
- (a) “Agency for the Cooperation of Energy Regulators” means the Agency established by Regulation (EU) 2019/942 of the European Parliament and of the Council of 5 June 2019 establishing a European Union Agency for the Cooperation of Energy Regulators<sup>42</sup>;
  - (b) “authorisation” means the permission, licence, concession or similar administrative or contractual instrument by which the competent authority of a Party entitles an entity to exercise a certain economic activity in its territory;
  - (c) “balancing” means:

---

<sup>42</sup> OJ EU L 158, 14.6.2019, p. 22.

- (i) for electricity systems, all actions and processes, in all timelines, through which electricity transmission system operators ensure, in an ongoing manner, maintenance of the system frequency within a predefined stability range and compliance with the amount of reserves needed with respect to the required quality;
  - (ii) for gas systems, actions undertaken by gas transmission system operators to change the gas flows onto or off the transmission network, excluding those actions related to gas unaccounted for as off-taken from the system and gas used by the transmission system operator for the operation of the system;
- (d) “distribution” means:
- (i) in relation to electricity, the transport of electricity on high-voltage, medium-voltage and low-voltage distribution systems with a view to its delivery to customers, but does not include supply;
  - (ii) in relation to gas, the transport of natural gas through local or regional pipeline networks with a view to its delivery to customers, but does not include supply;
- (e) “distribution system operator” means a natural or legal person who is responsible for operating, ensuring the maintenance of, and, if necessary, developing the electricity or gas distribution system in a given area and, where applicable, its interconnections with other systems, and for ensuring the long-term ability of the system to meet reasonable demands for the distribution of electricity or gas;
- (f) “electricity interconnector” means a transmission line:
- (i) between the Parties, excluding any such line wholly within the single electricity market in Ireland and Northern Ireland;
  - (ii) between Great Britain and the single electricity market in Ireland and Northern Ireland that is outside the scope of point (i);
- (g) “energy goods” means the goods from which energy is generated, listed by the corresponding Harmonised System (HS) code in Annex ENER-1;
- (h) “entity” means any natural person, legal person or enterprise or group thereof;
- (i) “gas interconnector” means a transmission line which crosses or spans the border between the Parties;
- (j) “generation” means the production of electricity;
- (k) “hydrocarbons” means the goods listed by the corresponding HS code in Annex ENER-1;
- (l) “interconnection point” means, in relation to gas, a physical or virtual point connecting Union and United Kingdom entry-exit systems or connecting an entry-exit system with an interconnector, in so far as these points are subject to booking procedures by network users;
- (m) “raw materials” means the goods listed by the corresponding HS chapter in Annex ENER-1;



- (n) “renewable energy” means a type of energy, including electrical energy, produced from renewable non-fossil sources;
- (o) “standard capacity product” means, in relation to gas, a certain amount of transport capacity over a given period of time, at a specific interconnection point;
- (p) “transmission” means:
  - (i) in relation to electricity, the transport of electricity on the extra high-voltage and high-voltage system with a view to its delivery to customers or to distributors, but does not include supply;
  - (ii) in relation to gas, the transport of natural gas through a network, which mainly contains high-pressure pipelines, other than an upstream pipeline network and other than the part of high-pressure pipelines primarily used in the context of local distribution of natural gas, with a view to its delivery to customers, but not including supply;
- (q) “transmission system operator” means a natural or legal person who carries out the function of transmission or is responsible for operating, ensuring the maintenance of, and, if necessary, developing the electricity or gas transmission system in a given area and, where applicable, its interconnections with other systems, and for ensuring the long-term ability of the system to meet reasonable demands for the transport of gas or electricity, as the case may be;
- (r) “upstream pipeline network” means any pipeline or network of pipelines operated or constructed as part of an oil or gas production project, or used to convey natural gas from one or more such projects to a processing plant or terminal or final coastal landing terminal.

2. For the purposes of this Title, references to “non-discriminatory” and “non-discrimination” mean most-favoured-nation treatment as defined in Articles SERVIN.2.4 [Most Favoured Nation Treatment] and 3.5[Most Favoured Nation Treatment] and national treatment as defined in Articles SERVIN. 2.3 [National Treatment] and 3.4 [National Treatment], as well as treatment under terms and conditions no less favourable than that accorded to any other like entity in like situations.

#### Article ENER.3: Relationship with other Titles

1. Chapters 2 [Investment liberalisation] and 3 [Cross-border trade in services] of Title II apply to energy and raw materials. In the event of any inconsistency between this Title and Title II [Services and investment] and the Annexes SERVIN-1 to SERVIN-6, Title II [Services and investment] and the Annexes SERVIN-1 to SERVIN-6 shall prevail.

2. For the purposes of Article GOODS.4A [Freedom of transit], where a Party maintains or implements a system of virtual trading of natural gas or electricity using pipelines or electricity grids, meaning a system which does not require physical identification of the transited natural gas or electricity but is based on a system of netting inputs and outputs, the routes most convenient for international transit as referred to in that Article shall be deemed to include such virtual trading.

3. When applying Chapter 3 [Subsidy control] of Title XI [Level playing field for open and fair competition and sustainable development], Annex ENER-2 also applies. Chapter 3 [Subsidy control] of Title XI [Level playing field for open and fair competition and sustainable development] applies to

Annex ENER-2. Article 3.13 [Dispute settlement] of Chapter 3 of Title XI [Level playing field for open and fair competition and sustainable development] applies to disputes arising between the Parties concerning the interpretation and application of Annex ENER-2.

#### Article ENER.4: Principles

Each Party preserves the right to adopt, maintain and enforce measures necessary to pursue legitimate public policy objectives, such as securing the supply of energy goods and raw materials, protecting society, the environment, including fighting against climate change, public health and consumers and promoting security and safety, consistent with the provisions of this Agreement.

### Chapter 2: Electricity and gas

#### *Section 1: Competition in electricity and gas markets*

##### Article ENER.5: Competition in markets and non-discrimination

1. With the objective of ensuring fair competition, each Party shall ensure that its regulatory framework for the production, generation, transmission, distribution or supply of electricity or natural gas is non-discriminatory with regard to rules, fees and treatment.
2. Each Party shall ensure that customers are free to choose, or switch to, the electricity or natural gas supplier of their choice within their respective retail markets in accordance with the applicable laws and regulations.
3. Without prejudice to the right of each Party to define quality requirements, the provisions in this Chapter related to natural gas also apply to biogas and gas from biomass or other types of gas in so far as such gas can technically and safely be injected into, and transported through, the natural gas system.
4. This Article does not apply to cross-border trade and is without prejudice to each Party's right to regulate in order to achieve legitimate public policy goals based on objective and non-discriminatory criteria.

##### Article ENER.6: Provisions relating to wholesale electricity and gas markets

1. Each Party shall ensure that wholesale electricity and natural gas prices reflect actual supply and demand. To this end, each Party shall ensure that wholesale electricity and natural gas market rules:
  - (a) encourage free price formation;
  - (b) do not set any technical limits on pricing that restrict trade;
  - (c) enable the efficient dispatch of electricity generation assets, energy storage and demand response and the efficient use of the electricity system;
  - (d) enable the efficient use of the natural gas system; and

- (e) enable the integration of electricity from renewable energy sources, and ensure the efficient and secure operation and development of the electricity system.
2. Each Party shall ensure that balancing markets are organised in such a way as to ensure:
- (a) non-discrimination between participants and non-discriminatory access to participants;
  - (b) that services are defined in a transparent manner;
  - (c) that services are procured in a transparent, market-based manner, taking account of the advent of new technologies; and
  - (d) that producers of renewable energy are accorded reasonable and non-discriminatory terms when procuring products and services.

A Party may decide not to apply point (c) if there is a lack of competition in the market for balancing services.

3. Each Party shall ensure that any capacity mechanism in electricity markets is clearly defined, transparent, proportionate and non-discriminatory. Neither Party is required to permit capacity situated in the territory of the other Party to participate in any capacity mechanism in its electricity markets.

4. Each Party shall assess the necessary actions to facilitate the integration of gas from renewable sources.

5. This Article is without prejudice to each Party's right to regulate in order to achieve legitimate public policy goals based on objective and non-discriminatory criteria.

#### Article ENER.7: Prohibition of market abuse on wholesale electricity and gas markets

1. Each Party shall prohibit market manipulation and insider trading on wholesale electricity and natural gas markets, including over-the-counter markets, electricity and natural gas exchanges and markets for the trading of electricity and natural gas, capacity, balancing and ancillary services in all timeframes, including forward, day-ahead and intraday markets.

2. Each Party shall monitor trading activity on these markets with a view to detecting and preventing trading based on inside information and market manipulation.

3. The Parties shall cooperate, including in accordance with Article ENER.20 [Cooperation between regulatory authorities], with a view to detecting and preventing trading based on inside information and market manipulation and, where appropriate, may exchange information including on market monitoring and enforcement activities.

#### Article ENER.8: Third-party access to transmission and distribution networks

1. Each Party shall ensure the implementation of a system of third-party access to their transmission and distribution networks based on published tariffs that are applied objectively and in a non-discriminatory manner.

2. Without prejudice to Article ENER.4 [Principles], each Party shall ensure that transmission and distribution system operators in its territory grant access to their transmission or distribution systems to entities in that Party's market within a reasonable period of time from the date of the request for access.

Each Party shall ensure that transmission system operators treat producers of renewable energy on reasonable and non-discriminatory terms regarding connection to, and use of, the electricity network.

The transmission or distribution system operator may refuse access where it lacks the necessary capacity. Duly substantiated reasons shall be given for any such refusal.

3. Without prejudice to legitimate public policy objectives, each Party shall ensure that charges applied to entities in that Party's market by transmission and distribution system operators for access to, connection to or the use of networks, and, where applicable, charges for related network reinforcements, are appropriately cost-reflective and transparent. Each Party shall ensure publication of the terms, conditions, tariffs and all such information that may be necessary for the effective exercise of the right of access to, and use of, transmission and distribution systems.

4. Each Party shall ensure that the tariffs and charges referred to in paragraphs 1 and 3 are applied in a non-discriminatory manner with respect to entities in that Party's market.

#### Article ENER.9: System operation and unbundling of transmission network operators

1. Each Party shall ensure that transmission system operators carry out their functions in a transparent, non-discriminatory way.

2. Each Party shall implement arrangements for transmission system operators which are effective in removing any conflicts of interest arising as a result of the same person exercising control over a transmission system operator and a producer or supplier.

#### Article ENER.10: Public policy objectives for third-party access and ownership unbundling

1. Where necessary to fulfil a legitimate public policy objective and based on objective criteria, a Party may decide not to apply Articles ENER.8 [Third-party access to transmission and distribution networks] and ENER.9 [System operation and unbundling of transmission network operators] to the following:

- (a) emergent or isolated markets or systems;
- (b) infrastructure which meets the conditions set out in Annex ENER-3.

2. Where necessary to fulfil a legitimate public policy objective and based on objective criteria, a Party may decide not to apply Articles ENER.5 [Competition in markets and non-discrimination] and ENER.6 [Provisions relating to wholesale electricity and gas markets] to:

- (a) small or isolated electricity markets or systems;
- (b) small, emergent or isolated natural gas markets or systems.

#### Article ENER.11: Existing exemptions for interconnectors

Each Party shall ensure that exemptions granted to interconnections between the Union and the United Kingdom under Article 63 of Regulation (EU) 2019/943 of the European Parliament and of the Council<sup>43</sup> and under the law transposing Article 36 of the Directive 2009/73/EC of the European Parliament and of the Council<sup>44</sup> in their respective jurisdictions, the terms of which extend beyond the transition period, continue to apply in accordance with the laws of their respective jurisdictions and the terms applicable.

#### Article ENER.12: Independent regulatory authority

1. Each Party shall ensure the designation and maintenance of an operationally independent regulatory authority or authorities for electricity and gas with the following powers and duties:

- (a) fixing or approving the tariffs, charges and conditions for access to networks referred to in Article ENER.8 [Third-party access to transmission and distribution networks], and the methodologies underlying them;
- (b) ensuring compliance with the arrangements referred to in Articles ENER.9 [System operation and unbundling of transmission network operators] and ENER.10 [Public policy objectives and third-party access and ownership unbundling];
- (c) issuing binding decisions at least in relation to points (a) and (b);
- (d) imposing effective remedies.

2. In performing those duties and exercising those powers, the independent regulatory authority or authorities shall act impartially and transparently.

#### *Section 2: Trading over interconnectors*

---

<sup>43</sup> Regulation (EU) 2019/943 of the European Parliament and of the Council of 5 June 2019 on the internal market for electricity (OJ EU L 158, 14.6.2019, p. 54).

<sup>44</sup> Directive 2009/73/EC of the European Parliament and of the Council of 13 July 2009 concerning common rules for the internal market in natural gas (OJ EU L 211, 14.8.2009, p. 94).

### Article ENER.13: Efficient use of electricity interconnectors

1. With the aim of ensuring the efficient use of electricity interconnectors and reducing barriers to trade between the Union and the United Kingdom, each Party shall ensure that:

- (a) capacity allocation and congestion management on electricity interconnectors is market based, transparent and non-discriminatory;
- (b) the maximum level of capacity of electricity interconnectors is made available, respecting the:
  - (i) need to ensure secure system operation; and
  - (ii) most efficient use of systems;
- (c) electricity interconnector capacity may only be curtailed in emergency situations and any such curtailment takes place in a non-discriminatory manner;
- (d) information on capacity calculation is published to support the objectives of this Article;
- (e) there are no network charges on individual transactions on, and no reserve prices for the use of, electricity interconnectors;
- (f) capacity allocation and congestion management across electricity interconnectors is coordinated between concerned Union transmission system operators and United Kingdom transmission system operators; this coordination shall involve the development of arrangements to deliver robust and efficient outcomes for all relevant timeframes, being forward, day-ahead, intraday and balancing; and
- (g) capacity allocation and congestion management arrangements contribute to supportive conditions for the development of, and investment in, economically efficient electricity interconnection.

2. The coordination and arrangements referred to in point (f) of paragraph 1 shall not involve or imply participation by United Kingdom transmission system operators in Union procedures for capacity allocation and congestion management.

3. Each Party shall take the necessary steps to ensure the conclusion as soon as possible of a multi-party agreement relating to the compensation for the costs of hosting cross-border flows of electricity between:

- (a) transmission system operators participating in the inter-transmission system operator compensation mechanism established by Commission Regulation (EU) No 838/2010<sup>45</sup>; and

---

<sup>45</sup> Commission Regulation (EU) No 838/2010 of 23 September 2010 on laying down guidelines relating to the inter-transmission system operator compensation mechanism and a common regulatory approach to transmission charging (OJ EU L 250, 24.9.2010, p. 5).

(b) United Kingdom transmission system operators.

4. The multi-party agreement referred to in paragraph 3 shall aim to ensure:

(a) that United Kingdom transmission system operators are treated on an equivalent basis to a transmission system operator in a country participating in the inter-transmission system operator compensation mechanism; and

(b) the treatment of United Kingdom transmission system operators is not more favourable in comparison to that which would apply to a transmission system operator participating in the inter-transmission system operator compensation mechanism.

5. Notwithstanding point (e) of paragraph 1, until such time as the multi-party agreement referred to in paragraph 3 has been concluded, a transmission system use fee may be levied on scheduled imports and exports between the Union and the United Kingdom.

#### Article 14: Electricity trading arrangements at all timeframes

1. For capacity allocation and congestion management at the day ahead stage, the Specialised Committee on Energy, as a matter of priority, shall take the necessary steps in accordance with Article ENER.19 [Cooperation between transmission system operators] to ensure that transmission system operators develop arrangements setting out technical procedures in accordance with Annex ENER-4 within a specific timeline.

2. If the Specialised Committee on Energy does not recommend that the Parties implement such technical procedures in accordance with Article ENER.19(4) [Cooperation between transmission system operators], it shall take decisions and make recommendations as necessary for electricity interconnector capacity to be allocated at the day-ahead market timeframe in accordance with Annex ENER-4.

3. The Specialised Committee on Energy shall keep under review the arrangements for all timeframes, and for balancing and intraday timeframes in particular, and may recommend that each Party requests its transmission system operators to prepare technical procedures in accordance with Article ENER.19 [Cooperation between transmission system operators] to improve arrangements for a particular timeframe.

4. The Specialised Committee on Energy shall keep under review whether the technical procedures developed in accordance with paragraph 1 continue to meet the requirements of Annex ENER-4, and shall promptly address any issues that are identified.

#### Article ENER.15: Efficient use of gas interconnectors

1. With the aim of ensuring the efficient use of gas interconnectors and reducing barriers to trade between the Union and the United Kingdom, each Party shall ensure that:

(a) the maximum level of capacity of gas interconnectors is made available, respecting the principle of non-discrimination and taking account of:

(i) the need to ensure secure system operation; and

- (ii) the most efficient use of systems;
  - (b) capacity allocation mechanisms and congestion management procedures for gas interconnectors are market-based, transparent and non-discriminatory, and that auctions are generally used for the allocation of capacity at interconnection points.
2. Each Party shall take the necessary steps to ensure that:
- (a) transmission system operators endeavour to offer jointly standard capacity products which consist of corresponding entry and exit capacity at both sides of an interconnection point;
  - (b) transmission system operators coordinate procedures relating to the use of gas interconnectors between Union transmission system operators and United Kingdom transmission system operators concerned.
3. The coordination referred to in point (b) of paragraph 2 shall not involve or imply participation by United Kingdom transmission system operators in Union procedures relating to the use of gas interconnectors.

### *Section 3: Network development and security of supply*

#### Article ENER.16: Network development

1. The Parties shall cooperate to facilitate the timely development and interoperability of energy infrastructure connecting their territories.
2. Each Party shall ensure that network development plans for electricity and gas transmission systems are drawn up, published and regularly updated.

#### Article ENER.17: Cooperation on security of supply

1. The Parties shall cooperate with respect to the security of supply of electricity and natural gas.
2. The Parties shall exchange information on any risks identified pursuant to Article ENER.18 [Risk preparedness and emergency plans] in a timely manner.
3. The Parties shall share the plans referred to in Article ENER.18 [Risk preparedness and emergency plans]. For the Union, these plans may be at Member State or regional level.
4. The Parties shall inform each other without undue delay where there is reliable information that a disruption or other crisis relating to the supply of electricity or natural gas may occur and on measures planned or taken.
5. The Parties shall immediately inform each other in the event of an actual disruption or other crisis, in view of possible coordinated mitigation and restoration measures.



6. The Parties shall share best practices regarding short-term and seasonal adequacy assessments.

7. The Parties shall develop appropriate frameworks for cooperation with respect to the security of supply of electricity and natural gas.

#### Article ENER.18: Risk preparedness and emergency plans

1. Each Party shall assess risks affecting the security of supply of electricity or natural gas, including the likelihood and impact of such risks, and including cross-border risks.

2. Each Party shall establish and regularly update plans to address identified risks affecting the security of supply of electricity or natural gas. Such plans shall contain the measures needed to remove or mitigate the likelihood and impact of any risk identified under paragraph 1 and the measures needed to prepare for, and mitigate the impact of, an electricity or natural gas crisis.

3. The measures contained in the plans referred to in paragraph 2 shall:

- (a) be clearly defined, transparent, proportionate, non-discriminatory and verifiable;
- (b) not significantly distort trade between the Parties; and
- (c) not endanger the security of supply of electricity or natural gas of the other Party.

In the event of a crisis, the Parties shall only activate non-market based measures as a last resort.

#### *Section 4: Technical cooperation*

#### Article ENER.19: Cooperation between transmission system operators

1. Each Party shall ensure that transmission system operators develop working arrangements that are efficient and inclusive in order to support the planning and operational tasks associated with meeting the objectives of this Title, including, when recommended by the Specialised Committee on Energy, the preparation of technical procedures to implement effectively the provisions of:

- (a) Article ENER.13 [Efficient use of electricity interconnectors];
- (b) Article ENER.14 [Electricity trading arrangements at all timeframes];
- (c) Article ENER.15 [Efficient use of gas interconnectors];
- (d) Article ENER.16 [Network development]; and
- (e) Article ENER.17 [Cooperation on security of supply].

The working arrangements referred to in the first subparagraph shall include frameworks for cooperation between the European Network of Transmission System Operators for Electricity

established in accordance with Regulation (EU) 2019/943 (“ENTSO-E”) and the European Network of Transmission System Operators for Gas established in accordance with Regulation (EC) No 715/2009 of the European Parliament and of the Council<sup>46</sup> (“ENTSOG”), on the one side, and the transmission system operators for electricity and gas in the United Kingdom, on the other. Those frameworks shall cover at least the following areas:

- (a) electricity and gas markets;
- (b) access to networks;
- (c) the security of electricity and gas supply;
- (d) offshore energy;
- (e) infrastructure planning;
- (f) the efficient use of electricity and gas interconnectors; and
- (g) gas decarbonisation and gas quality.

The Specialised Committee on Energy shall agree on guidance on the working arrangements and frameworks for cooperation for dissemination to transmission system operators as soon as practicable.

The frameworks for cooperation mentioned in the second subparagraph shall not involve, or confer a status comparable to, membership in ENTSO-E or ENTSOG by United Kingdom transmission system operators.

2. The Specialised Committee on Energy may recommend that each Party requests its transmission system operators to prepare the technical procedures as referred to in the first subparagraph of paragraph 1.

3. Each Party shall ensure that its respective transmission system operators request the opinions of the Agency for the Cooperation of Energy Regulators and the regulatory authority in the United Kingdom designated in accordance with Article ENER.12 [Independent regulatory authority] on the technical procedures, respectively, in the event of a disagreement and in any event before the finalisation of those technical procedures. The Parties’ respective transmission system operators shall submit those opinions together with the draft technical procedures to the Specialised Committee on Energy.

4. The Specialised Committee on Energy shall review the draft technical procedures, and may recommend that the Parties implement such procedures in their respective domestic arrangements,

---

<sup>46</sup> Regulation (EC) No 715/2009 of the European Parliament and of the Council of 13 July 2009 on conditions for access to the natural gas transmission networks and repealing Regulation (EC) No 1775/2005 (OJ EU L 211, 14.8.2009, p. 36).

taking due account of the opinions of the Agency for the Cooperation of Energy Regulators and the regulatory authority in the United Kingdom designated in accordance with Article ENER.12 [Independent regulatory authority]. The Specialised Committee on Energy shall monitor the effective operation of such technical procedures and may recommend that they be updated.

#### Article ENER.20: Cooperation between regulatory authorities

1. The Parties shall ensure that the Agency for the Cooperation of Energy Regulators and the regulatory authority in the United Kingdom designated in accordance with Article ENER.12 [Independent regulatory authority] develop contacts and enter into administrative arrangements as soon as possible in order to facilitate meeting the objectives of this Agreement. The contacts and administrative arrangements shall cover at least the following areas:

- (a) electricity and gas markets;
- (b) access to networks;
- (c) the prevention of market abuse on wholesale electricity and gas markets;
- (d) the security of electricity and gas supply;
- (e) infrastructure planning;
- (f) offshore energy;
- (g) the efficient use of electricity and gas interconnectors;
- (h) cooperation between transmission system operators; and
- (i) gas decarbonisation and gas quality.

The Specialised Committee on Energy shall agree on guidance on the administrative arrangements for such cooperation for dissemination to regulatory authorities as soon as practicable.

2. The administrative arrangements referred to in paragraph 1 shall not involve, or confer a status comparable to, participation in the Agency for the Cooperation of Energy Regulators by the regulatory authority in the United Kingdom designated in accordance with Article ENER.12 [Independent regulatory authority].

### Chapter 3: Safe and sustainable energy

#### Article ENER.21: Renewable energy and energy efficiency

1. Each Party shall promote energy efficiency and the use of energy from renewable sources.

Each Party shall ensure that its rules that apply to licencing or equivalent measures applicable to energy from renewable sources are necessary and proportionate.

2. The Union reaffirms the target for the share of gross final energy consumption from renewable energy sources in 2030 as set out in Directive (EU) 2018/2001 of the European Parliament and of the Council<sup>47</sup>.

The Union reaffirms its energy efficiency targets for 2030 as set out in the Directive 2012/27/EU of the European Parliament and of the Council<sup>48</sup>.

3. The United Kingdom reaffirms:

- (a) its ambition for the share of energy from renewable sources in gross final energy consumption in 2030 as set out in its National Energy and Climate Plan;
- (b) its ambition for the absolute level of primary and final energy consumption in 2030 as set out in its National Energy and Climate Plan.

4. The Parties shall keep each other informed in relation to the matters referred to in paragraphs 2 and 3.

#### Article ENER.22: Support for renewable energy

1. Each Party shall ensure that support for electricity from renewable sources facilitates the integration of electricity from renewable sources in the electricity market.

2. Biofuels, bioliquids and biomass shall only be supported as renewable energy if they meet robust criteria for sustainability and greenhouse gas emissions saving, which are subject to verification.

3. Each Party shall clearly define any technical specifications which are to be met by renewable energy equipment and systems in order to benefit from support schemes. Such technical specifications shall take into account cooperation developed under Article ENER.25 [Cooperation on standards], Article TBT.4 [Technical regulations] and Article TBT.5 [Standards].

#### Article ENER.23: Cooperation in the development of offshore renewable energy

1. The Parties shall cooperate in the development of offshore renewable energy by sharing best practices and, where appropriate, by facilitating the development of specific projects.

2. Building on the North Seas Energy Cooperation, the Parties shall enable the creation of a specific forum for technical discussions between the European Commission, ministries and public authorities of the Member States, United Kingdom ministries and public authorities, transmission system operators and the offshore energy industry and stakeholders more widely, in relation to

---

<sup>47</sup> Directive (EU) 2018/2001 of the European Parliament and of the Council of 11 December 2018 on the promotion of the use of energy from renewable sources (OJ EU L 328, 21.12.2018, p. 82).

<sup>48</sup> Directive 2012/27/EU of the European Parliament and of the Council of 25 October 2012 on energy efficiency (OJ EU L 315, 14.11.2012, p.1).

offshore grid development and the large renewable energy potential of the North Seas region. That cooperation shall include at least the following areas:

- (a) hybrid and joint projects;
- (b) maritime spatial planning;
- (c) support framework and finance;
- (d) best practices on respective onshore and offshore grid planning;
- (e) the sharing of information on new technologies; and
- (f) the exchange of best practices in relation to the relevant rules, regulations and technical standards.

#### Article ENER.24: Offshore risk and safety

1. The Parties shall cooperate and exchange information with the aim of maintaining high levels of safety and environmental protection for all offshore oil and gas operations.
2. The Parties shall take appropriate measures to prevent major accidents from offshore oil and gas operations and to limit the consequences of such accidents.
3. The Parties shall promote the exchange of best practices among their authorities that are competent for the safety and environmental protection of offshore oil and gas operations. The regulation of the safety and environmental protection of offshore oil and gas operations shall be independent from any functions relating to licensing of offshore oil and gas operations.

#### Article ENER.25: Cooperation on standards

In accordance with Article TBT.5 [Standards] and Article TBT.11 [Cooperation], the Parties shall promote cooperation between the regulators and standardisation bodies located within their respective territories to facilitate the development of international standards with respect to energy efficiency and renewable energy, with a view to contributing to sustainable energy and climate policy.

#### Article ENER.26: Research, development and innovation

The Parties shall promote research, development and innovation in the areas of energy efficiency and renewable energy.

#### Chapter 4: Energy goods and raw materials

#### Article ENER.27: Export pricing

A Party shall not impose a higher price for exports of energy goods or raw materials to the other Party than the price charged for those energy goods or raw materials when destined for the domestic market, by means of any measures such as licences or minimum price requirements.

#### Article ENER.28: Regulated pricing

If a Party decides to regulate the price of the domestic supply to consumers of electricity or natural gas, it may do so only to achieve a public policy objective, and only by imposing a regulated price that is clearly defined, transparent, non-discriminatory and proportionate.

#### Article ENER.29: Authorisation for exploration and production of hydrocarbons and generation of electricity

1. If a Party requires an authorisation for exploration or production of hydrocarbons or generation of electricity, that Party shall grant such authorisations on the basis of objective and non-discriminatory criteria which are drawn up and published before the start of the period for submission of applications in accordance with the general conditions and procedures set out in Section 1 [Domestic regulation] of Chapter 5 [Regulatory framework] of Title II [Services and investment].

2. Notwithstanding paragraph 1 of this Article and Article ENER.3 [Relationship with other Titles], each Party may grant authorisations related to exploration for or the production of hydrocarbons without complying with the conditions and procedures related to publication set out in Article SERVIN.5.8 [Publication and information available] on the basis of duly justified exemptions as provided for in applicable legislation.

3. Financial contributions or contributions in kind required from entities to which an authorisation is granted shall not interfere with the management and decision-making process of such entities.

4. Each Party shall provide that an applicant for authorisation has the right to appeal any decision concerning the authorisation to an authority higher than or independent from the authority that issued the decision or to request that such a higher or independent authority review that decision. Each Party shall ensure that the applicant is provided with the reasons for the administrative decision to enable the applicant to have recourse to the procedures for appeal or review if necessary. The applicable rules for appeal or review shall be published.

#### Article ENER.30: Safety and integrity of energy equipment and infrastructure

This Title shall not be construed as preventing a Party from adopting temporary measures necessary to protect the safety and preserve the integrity of energy equipment or infrastructure, provided that those measures are not applied in a manner which would constitute a disguised restriction on trade or investment between the Parties.

#### Chapter 5: Final provisions

#### Article ENER.31: Effective implementation and amendments

1. The Partnership Council may amend Annex ENER-1 and Annex ENER-3. The Partnership Council may update Annex ENER-2 as necessary to ensure the operation of that Annex over time.
2. The Specialised Committee on Energy may amend Annex ENER-4.
3. The Specialised Committee on Energy shall make recommendations as necessary to ensure the effective implementation of the Chapters of this Title for which it is responsible.

#### Article ENER.32: Dialogue

The Parties shall establish a regular dialogue to facilitate meeting the objectives of this Title.

#### Article ENER.33: Termination of this Title

1. This Title shall cease to apply on 30 June 2026.
2. Notwithstanding paragraph 1, between 1 July 2026 and 31 December 2026 the Partnership Council may decide that this Title will apply until 31 March 2027. Between 1 April 2027 and 31 December 2027, as well as at any point of time in any subsequent year, the Partnership Council may decide that this Title will apply until 31 March of the following year.
3. This Article applies without prejudice to Articles FISH.17 [Termination], FINPROV.8 [Termination] and OTH.10 [Termination of Part Two].

### *TITLE IX: TRANSPARENCY*

#### Article TRNSY.1: Objective

1. Recognising the impact that their respective regulatory environments may have on trade and investment between them, the Parties aim to provide a predictable regulatory environment and efficient procedures for economic operators, especially for small and medium-sized enterprises.
2. The Parties affirm their commitments in relation to transparency under the WTO Agreement, and build on those commitments in the provisions laid down in this Title.

#### Article TRNSY.2: Definition

For the purposes of this Title, “administrative decision” means a decision or action with legal effect that applies to a specific person, good or service in an individual case, and covers the failure to take a decision or take such action when that is so required by the law of a Party.

#### Article TRNSY.3: Scope

This Title applies with respect to Titles I to VIII and Titles X to XII and Heading Six [Other provisions].

#### Article TRNSY.4: Publication

1. Each Party shall ensure that its laws, regulations, procedures and administrative rulings of general application are promptly published via an officially designated medium, and, where feasible,

by electronic means, or are otherwise made available in such a manner as to enable any person to become acquainted with them.

2. To the extent appropriate, each Party shall provide an explanation of the objective of and rationale for measures referred to in paragraph 1.

3 Each Party shall provide a reasonable period of time between publication and entry into force of its laws and regulations, except when this is not possible for reasons of urgency.

#### Article TRNSY.5: Enquiries

1. Each Party shall establish or maintain appropriate and proportionate mechanisms for responding to questions from any person regarding any laws or regulations.

2. Each Party shall promptly provide information and respond to questions by the other Party pertaining to any law or regulation whether in force or planned, unless a specific mechanism is established under another provision of this Agreement.

#### Article TRNSY.6: Administration of measures of general application

1. Each Party shall administer its laws, regulations, procedures and administrative rulings of general application in an objective, impartial, and reasonable manner.

2. When administrative proceedings relating to persons, goods or services of the other Party are initiated in respect of the application of laws or regulations, each Party shall:

(a) endeavour to provide persons who are directly affected by the administrative proceedings with reasonable notice in accordance with its laws and regulations, including a description of the nature of the proceedings, a statement of the legal authority under which the proceedings are initiated and a general description of any issues in controversy; and

(b) afford such persons a reasonable opportunity to present facts and arguments in support of their positions prior to any final administrative decision insofar as time, the nature of the proceedings and the public interest permit.

#### Article TRNSY.7: Review and appeal

1. Each Party shall establish or maintain judicial, arbitral or administrative tribunals and procedures for the purpose of the prompt review and, if warranted, correction of administrative decisions. Each Party shall ensure that its tribunals carry out procedures for appeal or review in a non-discriminatory and impartial manner. Those tribunals shall be impartial and independent of the authority entrusted with administrative enforcement.

2. Each Party shall ensure that the parties to the proceedings as referred to in paragraph 1 are provided with a reasonable opportunity to support or defend their respective positions.

3. In accordance with its law, each Party shall ensure that any decisions adopted in proceedings as referred to in paragraph 1 are based on the evidence and submissions of record or, where applicable, on the record compiled by the competent administrative authority.



4. Each Party shall ensure that decisions as referred to in paragraph 3 shall be implemented by the authority entrusted with administrative enforcement, subject to appeal or further review as provided for in its law.

#### Article TRNSY.8: Relation to other Titles

The provisions set out in this Title supplement the specific transparency rules set out in those Titles of this Part with respect to which this Title applies.

### *TITLE X: GOOD REGULATORY PRACTICES AND REGULATORY COOPERATION*

#### Article GRP.1: General principles

1. Each Party shall be free to determine its approach to good regulatory practices under this Agreement in a manner consistent with its own legal framework, practice, procedures and fundamental principles<sup>49</sup> underlying its regulatory system.

2. Nothing in this Title shall be construed as requiring a Party to:

- (a) deviate from its domestic procedures for preparing and adopting regulatory measures;
- (b) take actions that would undermine or impede the timely adoption of regulatory measures to achieve its public policy objectives; or
- (c) achieve any particular regulatory outcome.

3. Nothing in this Title shall affect the right of a Party to define or regulate its own levels of protection in pursuit or furtherance of its public policy objectives in areas such as:

- (a) public health;
- (b) human, animal or plant life and health, and animal welfare;
- (c) occupational health and safety;
- (d) labour conditions;
- (e) environment including climate change;
- (f) consumer protection;
- (g) social protection and social security;
- (h) data protection and cybersecurity;
- (i) cultural diversity;
- (j) integrity and stability of the financial system, and protection of investors;

---

<sup>49</sup> For the Union, such principles include the precautionary principle.

- (k) energy security; and
- (l) anti-money laundering.

For greater certainty, for the purposes of in particular point (c) and (d) of the first subparagraph, the different models of industrial relations, including the role and autonomy of social partners, as provided for in the law or national practices of a Party, shall continue to apply, including laws and practices concerning collective bargaining and the enforcement of collective agreements.

4. Regulatory measures shall not constitute a disguised barrier to trade.

#### Article GRP.2: Definitions

For the purposes of this Title:

(a) “regulatory authority” means:

- (i) for the Union, the European Commission; and
- (ii) for the United Kingdom, Her Majesty’s Government of the United Kingdom of Great Britain and Northern Ireland, and the devolved administrations of the United Kingdom.

(b) “regulatory measures” means:

- (i) for the Union:
  - (A) regulations and directives, as provided for in Article 288 of the Treaty on the Functioning of the European Union (TFEU); and
  - (B) implementing and delegated acts, as provided for in Articles 290 and 291 TFEU, respectively; and
- (ii) for the United Kingdom:
  - (A) primary legislation; and
  - (B) secondary legislation.

#### Article GRP.3: Scope

1. This Title applies to regulatory measures proposed or issued, as relevant, by the regulatory authority of each Party in respect of any matter covered by Titles I to IX, Title XI and Title XII and Heading Six [Other provisions].

2. Articles GRP.12 [Regulatory cooperation activities] and GRP.13 [Trade Specialised Committee on Regulatory Cooperation] also apply to other measures of general application issued or proposed by the regulatory authority of a Party in respect of any matter covered by the Titles referred to in paragraph 1 which are relevant to regulatory cooperation activities, such as guidelines, policy documents or recommendations.

3. This Title does not apply to regulatory authorities and regulatory measures, regulatory practices or approaches of the Member States.

4. Any specific provisions in the Titles referred to in paragraph 1 shall prevail over the provisions of this Title to the extent necessary for the application of the specific provisions.

#### Article GRP.4: Internal coordination

Each Party shall have in place internal coordination or review processes or mechanisms with respect to regulatory measures that its regulatory authority is preparing. Such processes or mechanisms should seek, inter alia, to:

- (a) foster good regulatory practices, including those set forth in this Title;
- (b) identify and avoid unnecessary duplication and inconsistent requirements between the Party's own regulatory measures;
- (c) ensure compliance with the Party's international trade and investment obligations; and
- (d) promote the consideration of the impact of the regulatory measures under preparation, including the impact on small and medium-sized enterprises<sup>50</sup>, in accordance with its respective rules and procedures.

#### Article GRP.5: Description of processes and mechanisms

Each Party shall make publicly available descriptions of the processes or mechanisms used by its regulatory authority to prepare, evaluate or review regulatory measures. Those descriptions shall refer to relevant rules, guidelines or procedures, including those regarding opportunities for the public to provide comments.

#### Article GRP.6: Early information on planned regulatory measures

1. Each Party shall make publicly available, in accordance with its respective rules and procedures on at least an annual basis, a list of planned major<sup>51</sup> regulatory measures that its regulatory authority reasonably expects to propose or adopt within a year. The regulatory authority of each Party may determine what constitutes a major regulatory measure for the purposes of its obligations under this Title.

2. With respect to each major regulatory measure included in the list referred to in paragraph 1, each Party should also make publicly available, as early as possible:

- (a) a brief description of its scope and objectives; and
- (b) if available, the estimated time for its adoption, including any opportunities for public consultation.

---

<sup>50</sup> For the United Kingdom, "small and medium-sized enterprises" means small and micro-sized businesses.

<sup>51</sup> In the case of the United Kingdom, major regulatory measures shall be understood as significant regulatory measures in accordance with the definition of such measures in the United Kingdom's rules and procedures.

#### Article GRP.7: Public consultation

1. When preparing a major regulatory measure, each Party, in accordance with its respective rules and procedures, shall ensure that its regulatory authority:
  - (a) publishes either the draft regulatory measure or consultation documents providing sufficient details about the regulatory measure under preparation to allow any person to assess whether and how that person's interests might be significantly affected;
  - (b) offers, on a non-discriminatory basis, reasonable opportunities for any person to provide comments; and
  - (c) considers the comments received.
2. Each Party shall ensure that its regulatory authority makes use of electronic means of communication and shall seek to maintain online services that are available to the public free of charge for the purposes of publishing the relevant regulatory measures or documents of the kind referred to in point (a) of paragraph 1 and of receiving comments related to public consultations.
3. Each Party shall ensure that its regulatory authority makes publicly available, in accordance with its respective rules and procedures, a summary of the results of the public consultations referred to in this Article.

#### Article GRP.8: Impact assessment

1. Each Party affirms its intention to ensure that its regulatory authority carries out, in accordance with its respective rules and procedures, impact assessments for any major regulatory measures it prepares. Such rules and procedures may provide for exceptions.
2. When carrying out an impact assessment, each Party shall ensure that its regulatory authority has processes and mechanisms in place that promote the consideration of the following factors:
  - (a) the need for the regulatory measure, including the nature and the significance of the problem that the regulatory measure intends to address;
  - (b) any feasible and appropriate regulatory or non-regulatory options that would achieve the Party's public policy objectives, including the option of not regulating;
  - (c) to the extent possible and relevant, the potential social, economic and environmental impact of those options, including the impact on international trade and investment and, in accordance with its respective rules and procedures, the impact on small and medium-sized enterprises; and
  - (d) where appropriate, how the options under consideration relate to relevant international standards, including the reasons for any divergence.
3. With respect to an impact assessment that a regulatory authority has conducted for a regulatory measure, each Party shall ensure that its regulatory authority prepares a final report detailing the factors it considered in its assessment and its relevant findings. To the extent possible, each Party shall make such reports publicly available no later than when the proposal for a regulatory measure as referred to in point (b)(i)(A) or (b)(ii)(A) of Article GRP.2 [Definitions] or a

regulatory measure as referred to in point (b)(i)(B) or (b)(ii)(B) of Article GRP.2 [Definitions] has been made publicly available.

#### Article GRP.9: Retrospective evaluation

1. Each Party shall ensure that its regulatory authority has in place processes or mechanisms for the purpose of carrying out periodic retrospective evaluations of regulatory measures in force, where appropriate.
2. When conducting a periodic retrospective evaluation, each Party shall endeavour to consider whether there are opportunities to more effectively achieve its public policy objectives and to reduce unnecessary regulatory burdens, including on small and medium-sized enterprises.
3. Each Party shall ensure that its regulatory authority makes publicly available any existing plans for and the results of such retrospective evaluations.

#### Article GRP.10: Regulatory register

Each Party shall ensure that regulatory measures that are in effect are published in a designated register that identifies regulatory measures and that is publicly available online free of charge. The register should allow searches for regulatory measures by citations or by word. Each Party shall periodically update its register.

#### Article GRP.11: Exchange of information on good regulatory practices

The Parties shall endeavour to exchange information on their good regulatory practices as set out in this Title, including in the Trade Specialised Committee on Regulatory Cooperation.

#### Article GRP.12: Regulatory cooperation activities

1. The Parties may engage in regulatory cooperation activities on a voluntary basis, without prejudice to the autonomy of their own decision-making and their respective legal orders. A Party may refuse to engage in or it may withdraw from regulatory cooperation activities. A Party that refuses to engage in or that withdraws from regulatory cooperation activities should explain the reasons for its decision to the other Party.
2. Each Party may propose a regulatory cooperation activity to the other Party. It shall present its proposal via the contact point designated in accordance with Article GRP.14 [Contact points]. The other Party shall review that proposal within a reasonable period and shall inform the proposing Party whether it considers the proposed activity to be suitable for regulatory cooperation.
3. In order to identify activities that are suitable for regulatory cooperation, each Party shall consider:
  - (a) the list referred to in Article GRP.6(1) [Early information on planned regulatory measures]; and
  - (b) proposals for regulatory cooperation activities submitted by persons of a Party that are substantiated and accompanied by relevant information.
4. If the Parties decide to engage in a regulatory cooperation activity, the regulatory authority of each Party shall endeavour, where appropriate:

- (a) to inform the regulatory authority of the other Party about the preparation of new or the revision of existing regulatory measures and other measures of general application referred to in Article GRP.3(2) [Scope] that are relevant to the regulatory cooperation activity;
- (b) on request, to provide information and discuss regulatory measures and other measures of general application referred to in Article GRP.3(2) [Scope] that are relevant to the regulatory cooperation activity; and
- (c) when preparing new or revising existing regulatory measures or other measures of general application referred to in Article GRP.3(2) [Scope], consider, to the extent feasible, any regulatory approach by the other Party on the same or a related matter.

#### Article GRP.13: Trade Specialised Committee on Regulatory Cooperation

1. The Trade Specialised Committee on Regulatory Cooperation shall have the following functions:
  - (a) enhancing and promoting good regulatory practices and regulatory cooperation between the Parties;
  - (b) exchanging views with respect to the cooperation activities proposed or carried out under Article GRP.12 [Regulatory cooperation activities];
  - (c) encouraging regulatory cooperation and coordination in international fora, including, when appropriate, periodic bilateral exchanges of information on relevant ongoing or planned activities.
2. The Trade Specialised Committee on Regulatory Cooperation may invite interested persons to participate in its meetings.

#### Article GRP.14: Contact points

Within a month after the entry into force of this Agreement, each Party shall designate a contact point to facilitate the exchange of information between the Parties.

#### Article GRP.15: Non-application of dispute settlement

Title I [Dispute Settlement] of Part Six does not apply in respect of disputes regarding the interpretation and application of this Title.

### *TITLE XI: LEVEL PLAYING FIELD FOR OPEN AND FAIR COMPETITION AND SUSTAINABLE DEVELOPMENT*

#### Chapter one: General provisions

##### Article 1.1: Principles and objectives

1. The Parties recognise that trade and investment between the Union and the United Kingdom under the terms set out in this Agreement require conditions that ensure a level playing field for open and fair competition between the Parties and that ensure that trade and investment take place in a manner conducive to sustainable development.

2. The Parties recognise that sustainable development encompasses economic development, social development and environmental protection, all three being interdependent and mutually reinforcing, and affirm their commitment to promote the development of international trade and investment in a way that contributes to the objective of sustainable development.

3. Each Party reaffirms its ambition of achieving economy-wide climate neutrality by 2050.

4. The Parties affirm their common understanding that their economic relationship can only deliver benefits in a mutually satisfactory way if the commitments relating to a level playing field for open and fair competition stand the test of time, by preventing distortions of trade or investment, and by contributing to sustainable development. However the Parties recognise that the purpose of this Title is not to harmonise the standards of the Parties. The Parties are determined to maintain and improve their respective high standards in the areas covered by this Title.

#### Article 1.2: Right to regulate, precautionary approach<sup>52</sup> and scientific and technical information

1. The Parties affirm the right of each Party to set its policies and priorities in the areas covered by this Title, to determine the levels of protection it deems appropriate and to adopt or modify its law and policies in a manner consistent with each Party's international commitments, including its commitments under this Title.

2. The Parties acknowledge that, in accordance with the precautionary approach, where there are reasonable grounds for concern that there are potential threats of serious or irreversible damage to the environment or human health, the lack of full scientific certainty shall not be used as a reason for preventing a Party from adopting appropriate measures to prevent such damage.

3. When preparing or implementing measures aimed at protecting the environment or labour conditions that may affect trade or investment, each Party shall take into account relevant, available scientific and technical information, international standards, guidelines and recommendations.

#### Article 1.3 Dispute settlement

Title I [Dispute settlement] of Part Six [Dispute settlement and horizontal provisions] does not apply to this Chapter, except for Article 1.2(2) [Right to regulate, precautionary approach and scientific and technical information]. Articles 9.1 [Consultations] and 9.2 [Panel of experts] apply to Article 1.1(3) [Principles and objectives].

### Chapter two: Competition Policy

#### Article 2.1: Principles and definitions

1. The Parties recognise the importance of free and undistorted competition in their trade and investment relations. The Parties acknowledge that anticompetitive business practices may distort the proper functioning of markets and undermine the benefits of trade liberalisation.

2. For the purposes of this Chapter, an “economic actor” means an entity or a group of entities constituting a single economic entity, regardless of its legal status, that is engaged in an economic activity by offering goods or services on a market.

---

<sup>52</sup> For greater certainty, in relation to the implementation of this Agreement in the territory of the Union, the precautionary approach refers to the precautionary principle.

## Article 2.2: Competition law

1. In recognition of the principles set out in Article 2.1 [Principles and definitions], each Party shall maintain a competition law which effectively addresses the following anticompetitive business practices:
  - a) agreements between economic actors, decisions by associations of economic actors and concerted practices which have as their object or effect the prevention, restriction or distortion of competition;
  - b) abuse by one or more economic actors of a dominant position; and
  - c) for the United Kingdom, mergers or acquisitions and, for the Union, concentrations, between economic actors which may have significant anticompetitive effects.
2. The competition law referred to in paragraph 1 shall apply to all economic actors irrespective of their nationality or ownership status.
3. Each Party may provide for exemptions from its competition law in pursuit of legitimate public policy objectives, provided that those exemptions are transparent and are proportionate to those objectives.

## Article 2.3: Enforcement

1. Each Party shall take appropriate measures to enforce its competition law in its territory.
2. Each Party shall maintain an operationally independent authority or authorities competent for the effective enforcement of its competition law.
3. Each Party shall apply its competition law in a transparent and non-discriminatory manner, respecting the principles of procedural fairness, including the rights of defence of the economic actors concerned, irrespective of their nationality or ownership status.

## Article 2.4: Cooperation

1. To achieve the objectives of this Chapter and to enhance the effective enforcement of their respective competition law, the Parties recognise the importance of cooperation between their respective competition authorities with regard to developments in competition policy and enforcement activities.
2. For the purposes of paragraph 1, the European Commission or the competition authorities of the Member States, on the one side, and the United Kingdom's competition authority or authorities, on the other side, shall endeavour to cooperate and coordinate, with respect to their enforcement activities concerning the same or related conduct or transactions, where doing so is possible and appropriate.
3. To facilitate the cooperation and coordination referred to in paragraphs 1 and 2, the European Commission and the competition authorities of the Member States, on the one side, and the United Kingdom's competition authority or authorities, on the other side, may exchange information to the extent permitted by each Party's law.



4. To implement the objectives of this Article, the Parties may enter into a separate agreement on cooperation and coordination between the European Commission, the competition authorities of the Member States and the United Kingdom's competition authority or authorities, which may include conditions for the exchange and use of confidential information.

#### Article 2.5: Dispute settlement

This Chapter shall not be subject to dispute settlement under Title I [Dispute settlement] of Part Six [Dispute settlement and horizontal provisions].

#### Chapter three: Subsidy control

##### Article 3.1: Definitions

1. For the purposes of this Chapter:

- a) "economic actor" means an entity or a group of entities constituting a single economic entity, regardless of its legal status, that is engaged in an economic activity by offering goods or services on a market;
- b) "subsidy" means financial assistance which:
  - (i) arises from the resources of the Parties, including:
    - (A) a direct or contingent transfer of funds such as direct grants, loans or loan guarantees;
    - (B) the forgoing of revenue that is otherwise due; or
    - (C) the provision of goods or services, or the purchase of goods or services;
  - (ii) confers an economic advantage on one or more economic actors;
  - (iii) is specific insofar as it benefits, as a matter of law or fact, certain economic actors over others in relation to the production of certain goods or services; and
  - (iv) has, or could have, an effect on trade or investment between the Parties.

2. For the purposes of point (b)(iii) of paragraph 1:

- (a) a tax measure shall not be considered as specific unless:
  - (i) certain economic actors obtain a reduction in the tax liability that they otherwise would have borne under the normal taxation regime; and
  - (ii) those economic actors are treated more advantageously than others in a comparable position within the normal taxation regime; for the purposes of this point, a normal taxation regime is defined by its internal objective, by its features (such as the tax base, the taxable person, the taxable event or the tax rate) and by an authority which is autonomous institutionally, procedurally, economically and financially and has the competence to design the features of the taxation regime.

- (b) notwithstanding point (a), a subsidy shall not be regarded as specific if it is justified by principles inherent to the design of the general system. In the case of tax measures, examples of such inherent principles are the need to fight fraud or tax evasion, administrative manageability, the avoidance of double taxation, the principle of tax neutrality, the progressive nature of income tax and its redistributive purpose, or the need to respect taxpayers' ability to pay;
- (c) notwithstanding point (a), special purpose levies shall not be regarded as specific if their design is required by non-economic public policy objectives, such as the need to limit the negative impacts of certain activities or products on the environment or human health, insofar as the public policy objectives are not discriminatory<sup>53</sup>.

#### Article 3.2: Scope and exceptions

1. Article 3.4 [Principles], 3.5 [Prohibited subsidies and subsidies subject to conditions] and Article 3.12 [Remedial measures] do not apply to subsidies granted to compensate the damage caused by natural disasters or other exceptional non-economic occurrences.
2. Nothing in this Chapter prevents the Parties from granting subsidies of a social character that are targeted at final consumers.
3. Subsidies that are granted on a temporary basis to respond to a national or global economic emergency shall be targeted, proportionate and effective in order to remedy that emergency. Articles 3.5 [Prohibited subsidies and subsidies subject to conditions] and 3.12 [Remedial measures] do not apply to such subsidies.
4. This Chapter does not apply to subsidies where the total amount granted to a single economic actor is below 325,000 Special Drawing Rights over any period of three fiscal years. The Partnership Council may amend that threshold.
5. This Chapter does not apply to subsidies that are subject to the provisions of Part IV or Annex 2 of the Agreement on Agriculture and subsidies related to trade in fish and fish products.
6. This Chapter does not apply to subsidies related to the audio-visual sector.
7. Article 3.9 [Independent authority or body and cooperation] does not apply to subsidies financed by resources of the Parties at supranational level.
8. For the purposes of subsidies to air carriers, for any reference to "effect on trade or investment between the Parties" in this Chapter, there shall be substituted a reference to "effect on competition between air carriers of the Parties in the provision of air transport services", including those air transport services not covered under Title I [Air transport] of Heading 2 [Aviation].

#### Article 3.3: Services of public economic interest

1. Subsidies granted to economic actors assigned with particular tasks in the public interest, including public service obligations, are subject to Article 3.4 [Principles] insofar as the application of

---

<sup>53</sup> For this purpose, discrimination means that there is less favourable treatment of an economic actor compared with others in like situations and that that differential treatment is not justified by objective criteria'

the principles set out in that Article does not obstruct the performance in law or fact of the particular task assigned to the economic actor concerned. The task shall be assigned in advance in a transparent manner.

2. The Parties shall ensure that the amount of compensation granted to an economic actor that is assigned with a task in the public interest is limited to what is necessary to cover all or part of the costs incurred in the discharge of that task, taking into account the relevant receipts and a reasonable profit for discharging that task. The Parties shall ensure that the compensation granted is not used to cross-subsidise activities falling outside the scope of the assigned task. Compensation below 15 million Special Drawing Rights per task shall not be subject to the obligations under Article 3.7 [Transparency]. The Partnership Council may amend this threshold.

3. This Chapter does not apply where the total compensation to an economic actor providing tasks in the public interest is below 750,000 Special Drawing Rights over any period of three fiscal years. The Partnership Council may amend this threshold.

#### Article 3.4: Principles

1. With a view to ensuring that subsidies are not granted where they have or could have a material effect on trade or investment between the Parties, each Party shall have in place and maintain an effective system of subsidy control that ensures that the granting of a subsidy respects the following principles:

- a) subsidies pursue a specific public policy objective to remedy an identified market failure or to address an equity rationale such as social difficulties or distributional concerns (“the objective”);
- b) subsidies are proportionate and limited to what is necessary to achieve the objective;
- c) subsidies are designed to bring about a change of economic behaviour of the beneficiary that is conducive to achieving the objective and that would not be achieved in the absence of subsidies being provided;
- d) subsidies should not normally compensate for the costs the beneficiary would have funded in the absence of any subsidy;
- e) subsidies are an appropriate policy instrument to achieve a public policy objective and that objective cannot be achieved through other less distortive means;
- f) subsidies’ positive contributions to achieving the objective outweigh any negative effects, in particular the negative effects on trade or investment between the Parties.

2. Without prejudice to paragraph 1, each Party shall apply the conditions set out in Article 3.5 [Prohibited subsidies and subsidies subject to conditions], where relevant, if the subsidies concerned have or could have a material effect on trade or investment between the Parties.

3. It is for each Party to determine how its obligations under paragraphs 1 and 2 are implemented in the design of its subsidy control system in its own domestic law, provided that each Party shall ensure that the obligations in paragraphs 1 and 2 are implemented in its law in such a manner that the legality of an individual subsidy will be determined by the principles.

## Article 3.5 Prohibited subsidies and subsidies subject to conditions

1. The categories of the subsidies referred to in Article 3.4(2) [Principles] and the conditions to be applied to them are as follows. The Partnership Council may update these provisions as necessary to ensure the operation of this Article over time.

### *Unlimited state guarantees*

2. Subsidies in the form of a guarantee of debts or liabilities of an economic actor without any limitation as to the amount of those debts and liabilities or the duration of that guarantee shall be prohibited.

### *Rescue and restructuring*

3. Subsidies for restructuring an ailing or insolvent economic actor without the economic actor having prepared a credible restructuring plan shall be prohibited. The restructuring plan shall be based on realistic assumptions with a view to ensuring the return to long-term viability of the ailing or insolvent economic actor within a reasonable time period. During the preparation of the restructuring plan, the economic actor can receive temporary liquidity support in the form of loans or loan guarantees. Except for small and medium-sized enterprises, an economic actor or its owners, creditors or new investors shall contribute significant funds or assets to the cost of restructuring. For the purposes of this paragraph, an ailing or insolvent economic actor is one that would almost certainly go out of business in the short to medium term without the subsidy

4. Other than in exceptional circumstances, subsidies for the rescue and restructuring of insolvent or ailing economic actors should only be allowed if they contribute to an objective of public interest by avoiding social hardship or preventing a severe market failure, in particular with regard to job losses or disruption of an important service that is difficult to replicate. Except in the case of unforeseeable circumstances not caused by the beneficiary, they should not be granted more than once in any five year period.

5. Paragraphs 3 and 4 do not apply to subsidies to ailing or insolvent banks, credit institutions and insurance companies.

### *Banks, credit institutions and insurance companies*

6. Without prejudice to Article SERVIN 5.39 [Prudential carve-out], subsidies to restructure banks, credit institutions and insurance companies may only be granted on the basis of a credible restructuring plan that restores long-term viability. If a return to long-term viability cannot be credibly demonstrated, any subsidy to banks, credit institutions and insurance companies shall be limited to what is needed to ensure their orderly liquidation and exit from the market while minimising the amount of the subsidy and its negative effect on trade or investment between the Parties.

7. It shall be ensured that the granting authority is properly remunerated for the restructuring subsidy and that the beneficiary, its shareholders, its creditors or the business group to which the beneficiary belongs, contribute significantly to the restructuring or liquidation costs from their own resources. Subsidies to support liquidity provisions shall be temporary, shall not be used to absorb losses and shall not become capital support. Proper remuneration shall be paid to the granting authority for the subsidies granted to support liquidity provisions.

### *Export subsidies*

8. Subsidies that are contingent in law or in fact<sup>54</sup>, whether solely or as one of several other conditions, upon export performance relating to goods or services, shall be prohibited, except in relation to:

- (a) short-term credit insurance for non-marketable risks; or
- (b) export credits and export credit guarantee or insurance programmes that are permissible in accordance with the SCM Agreement, read with any adjustments necessary for context.

9. For the purposes of point (a) of paragraph 8 “marketable risk” means commercial and political risks with a maximum risk period of less than two years on public and non-public buyers in marketable risk countries<sup>55</sup>. A country may be understood to be temporarily removed from the group of marketable risk countries if there is a lack of sufficient private market capacity because of:

- (a) a significant contraction of private credit insurance capacity;
- (b) a significant deterioration of sovereign sector rating; or
- (c) a significant deterioration of corporate sector performance.

10. Such temporary removal of a marketable risk country shall take effect, as far as a Party is concerned, in accordance with a decision of that Party on the basis of the criteria in paragraph 9, and only if that Party adopts such a decision. The publication of that decision shall be deemed to constitute notification to the other Party of such temporary removal as far as the former Party is concerned.

11. If a subsidised insurer provides export credit insurance, any insurance for marketable risks shall be provided on a commercial basis. In such a case, the insurer shall not directly or indirectly benefit from subsidies for the provision of insurance for marketable risks.

#### *Subsidies contingent upon the use of domestic content*

12. Without prejudice to Article SERVIN 2.6 [Performance requirements] and Article SERVIN 2.7 [Non-conforming measures and exceptions], subsidies contingent, whether solely or as one of several other conditions, upon the use of domestic over imported goods or services shall be prohibited.

#### *Large cross border or international cooperation projects*

13. Subsidies may be granted in the context of large cross border or international cooperation projects, such as those for transport, energy, the environment, research and development, and first deployment projects to incentivise the emergence and deployment of new technologies (excluding manufacturing). The benefits of such cross border or international cooperation projects must not be limited to the economic actors or to the sector or the States participating, but must have wider

---

<sup>54</sup> For greater certainty, this standard is met when the facts demonstrate that the granting of a subsidy, without having been made legally contingent upon export performance, is in fact tied to actual or anticipated exportation or export earnings. The mere fact that a subsidy is granted to economic actors which export shall not for that reason alone be considered to be an export subsidy within the meaning of this provision.

<sup>55</sup> The marketable risk countries are the United Kingdom, the Member States of the Union, Australia, Canada, Iceland, Japan, New Zealand, Norway, Switzerland, and the United States of America.

benefit and relevance through spill over effects that do not exclusively accrue to the State that grants the subsidy, the relevant sector and beneficiary.

#### *Energy and environment*

14. The Parties recognise the importance of a secure, affordable and sustainable energy system and environmental sustainability, notably in relation to the fight against climate change which represent an existential threat to humanity. Therefore, without prejudice to Article 3.4 [Principles], the subsidies in relation to energy and environment shall be aimed at, and incentivise the beneficiary in, delivering a secure, affordable and sustainable energy system and a well-functioning and competitive energy market or increasing the level of environmental protection compared to the level that would be achieved in absence of the subsidy. Such subsidies shall not relieve the beneficiary from liabilities arising from its responsibilities as a polluter under the law of the relevant Party.

#### *Subsidies to air carriers for the operation of routes*

15. Subsidies shall not be granted to an air carrier<sup>56</sup> for the operation of routes except:
- (a) where there is a public service obligation, in accordance with Article 3.3 [Services of public economic interest];
  - (b) in special cases where this funding provides benefits for society at large; or
  - (c) as start-up subsidies for opening new routes to regional airports providing that it increases the mobility of citizens and stimulates regional development.

#### Article 3.6: Use of subsidies

Each Party shall ensure that economic actors use subsidies only for the specific purpose for which they are granted.

#### Article 3.7: Transparency

1. With respect to any subsidy granted or maintained within its territory, each Party shall within six months from the granting of the subsidy make publicly available, on an official website or a public database, the following information:
  - (a) the legal basis and policy objective or purpose of the subsidy;
  - (b) the name of the recipient of the subsidy when available;
  - (c) the date of the grant of the subsidy, the duration of the subsidy and any other time limits attached to the subsidy; and
  - (d) the amount of the subsidy or the amount budgeted for the subsidy.
2. For subsidies in the form of tax measures, the information shall be made public within one year from the date the tax declaration is due. The transparency obligations for subsidies in the form

---

<sup>56</sup> For greater certainty, this is without prejudice to paragraphs Article 3.2(1) and (2) [Scope and exceptions].

of tax measures concern the same information as listed in paragraph 1, except for the information required under point (d) of that paragraph, which may be provided as a range.

3. In addition to the obligation set out in paragraph 1, the Parties shall make subsidy information available in accordance with paragraphs 4 or 5 below.

4. For the Union, compliance with paragraph 3 means that with respect to any subsidy granted or maintained within its territory, within six months from the grant of the subsidy, information is made publicly available, on an official website or a public database, that allows interested parties to assess the compliance with the principles set out in Article 3.4 [Principles].

5. For the United Kingdom, compliance with paragraph 3 means that the United Kingdom shall ensure that:

- (a) if an interested party communicates to the granting authority that it may apply for a review by a court or tribunal of (i) the grant of a subsidy by a granting authority or (ii) any relevant decision by the granting authority or the independent body or authority;
- (b) then, within 28 days of the request being made in writing, the granting authority, independent body or authority will provide that interested party with the information that allows the interested party to assess the application of the principles set out in Article 3.4 [Principles], subject to any proportionate restrictions which pursue a legitimate objective, such as commercial sensitivity, confidentiality or legal privilege.

The information referred to in point (b) of the first sub-paragraph shall be provided to the interested party for the purposes of enabling it to make an informed decision as to whether to make a claim or to understand and properly identify the issues in dispute in the proposed claim.

6. For the purposes of this Article, Article 3.10 [Courts and tribunals] and Article 3.11 [Recovery], “interested party” means any natural or legal person, economic actor or association of economic actors whose interest might be affected by the granting of a subsidy, in particular the beneficiary, economic actors competing with the beneficiary or relevant trade associations.

7. The obligations in this Article are without prejudice to the obligations of the Parties under their respective laws concerning freedom of information or access to documents.

#### Article 3.8: Consultations on subsidy control

1. If a Party considers that a subsidy has been granted by the other Party or that there is clear evidence that the other Party intends to grant a subsidy and that the granting of the subsidy has or could have a negative effect on trade or investment between the Parties, it may request the other Party to provide an explanation of how the Principles referred to in Article 3.4 [Principles] have been respected with regard to that subsidy.

2. A Party may also request the information listed in Article 3.7(1) [Transparency] to the extent that the information has not already been made publicly available on an official website or a public database as referred to in Article 3.7(1) [Transparency], or to the extent that the information has not been made available in an easily and readily accessible manner.

3. The other Party shall provide the requested information in writing no later than 60 days of the receipt of the request. If any requested information cannot be provided, that Party shall explain the absence of such information in its written response.



4. If after receiving the information requested, the requesting Party still considers that the subsidy granted or intended to be granted by the other Party has or could have a negative effect on trade or investment between the Parties, the requesting Party may request consultations within the Trade Specialised Committee on the Level Playing Field for Open and Fair Competition and Sustainable Development. The request shall be in writing and shall include an explanation of the requesting Party's reasons for requesting the consultation.

5. The Trade Specialised Committee on the Level Playing Field for Open and Fair Competition and Sustainable Development shall make every attempt to arrive at a mutually satisfactory resolution of the matter. It shall hold its first meeting within 30 days of the request for consultation.

6. The timeframes for the consultations referred to in paragraphs 3 and 5 may be extended by agreement between the Parties.

#### Article 3.9: Independent authority or body and cooperation

1. Each Party shall establish or maintain an operationally independent authority or body with an appropriate role in its subsidy control regime. That independent authority or body shall have the necessary guarantees of independence in exercising its operational functions and shall act impartially.

2. The Parties shall encourage their respective independent authorities or bodies to cooperate with each other on issues of common interest within their respective functions, including the application of Articles 3.1 [Definitions] to 3.7 [Transparency] as applicable, within the limits established by their respective legal frameworks. The Parties, or their respective independent authorities or bodies, may agree upon a separate framework regarding cooperation between those independent authorities.

#### Article 3.10: Courts and tribunals

1. Each Party shall ensure, in accordance with its general and constitutional laws and procedures, that its courts or tribunals are competent to:

- a) review subsidy decisions taken by a granting authority or, where relevant, the independent authority or body for compliance with that Party's law implementing Article 3.4 [Principles];
- b) review any other relevant decisions of the independent authority or body and any relevant failure to act;
- c) impose remedies that are effective in relation to points a) or b), including suspension, prohibition or requirement of action by the granting authority, the award of damages, and recovery of subsidy from its beneficiary if and to the extent they are available under the respective laws on the date of entry into force of this Agreement;
- d) hear claims from interested parties in respect of subsidies that are subject to this Chapter; where an interested party has standing to bring a claim in respect of a subsidy under that Party's law.

2. Each Party shall have the right to intervene with the permission, where required, of the court or tribunal concerned, in accordance with the general laws and procedures of the other Party in cases referred to in paragraph 1.



3. Without prejudice to the obligations to maintain or, where necessary, to create the competencies, remedies and rights of intervention referred to in paragraphs 1 and 2 of this Article, and Article 3.11 [Recovery], nothing in this Article requires either Party to create rights of action, remedies, procedures, or the scope or grounds of review of decisions of their respective public authorities, beyond those existing under its law on the date of entry into force of this Agreement.

Nothing in this Article requires either Party to widen the scope or grounds of review by its courts and tribunals of Acts of the United Kingdom Parliament, of acts of the European Parliament and the Council of the European Union, or of acts of the Council of the European Union beyond those existing under its law on the date of entry into force of this Agreement.<sup>57</sup>

#### Article 3.11: Recovery

1. Each Party shall have in place an effective mechanism of recovery in respect of subsidies in accordance with the following provisions, without prejudice to other remedies that exist in that Party's law.<sup>58</sup>

2. Each Party shall ensure that, provided that the interested party as defined in Article 3.7(6) [Transparency] has challenged a decision to grant a subsidy before a court or a tribunal within the specified time period, as defined in paragraph 3 of this Article, recovery may be ordered if a court or tribunal of a Party makes a finding of a material error of law, in that:

- (a) a measure constituting a subsidy was not treated by the grantor as a subsidy;
- (b) the grantor of a subsidy has failed to apply the principles set out in Article 3.4 [Principles], as implemented in that Party's law, or applied them in a manner which falls below the standard of review applicable in that Party's law; or
- (c) the grantor of a subsidy has, by deciding to grant that subsidy, acted outside the scope of its powers or misused those powers in relation to the principles set out in Article 3.4 [Principles], as implemented in that Party's law.

3. For the purposes of this Article, the specified time period shall be determined as follows:

(a) for the Union, it shall commence on the date on which information specified in Article 3.7(1), (2) and (4) [Transparency] was made available on the official website or public database and be no shorter than one month.

(b) for the United Kingdom:

- (i) it shall commence on the date on which information specified in Article 3.7(1) and (2) [Transparency] was made available on the official website or public database;

---

<sup>57</sup> For greater certainty, the law of the United Kingdom for the purposes of this Article does not include any law [i] having effect by virtue of section 2(1) of the European Communities Act 1972, as saved by section 1A of the European Union (Withdrawal) Act 2018, or [ii] passed or made under, or for a purpose specified in section 2(2) of the European Communities Act 1972.

<sup>58</sup> For the United Kingdom, this Article requires a new remedy of recovery which would be available at the end of a successful judicial review, in accordance with the standard of review under national law, commenced within the specified time period; such review is not expanded in any other way, in accordance with Article 3.10(3) [Courts and tribunals]. No beneficiary would be able to raise a legitimate expectation to resist such recovery.

- (ii) it shall terminate one month later, unless, prior to that date, the interested party has requested information under the process specified in paragraph 5 of Article 3.7;
- (iii) once the interested party has received the information identified in Article 3.7(5)(b) sufficient for the purposes identified in that paragraph, there shall be a further one month period at the end of which the specified time period shall terminate;
- (iv) the date of receipt of the information in point (iii) will be the date on which the granting authority certifies that it has provided the information identified in Article 3.7(5)(b) [Transparency] sufficient for those purposes, irrespective of further or clarificatory correspondence after that date;
- (v) the time periods identified in points (i) to (iii) may be increased by legislation.

4. For the purposes of paragraph 3(b), in relation to schemes, the specified time period commences when the information under point (b) is published, not when subsequent payments are made, where:

- (a) a subsidy is ostensibly granted in accordance with the terms of a scheme;
- (b) the maker of the scheme has made publicly available the information required to be published by Article 3.7(1) and (2) [Transparency] in respect of the scheme; and
- (c) the information provided about the scheme under point (b) contains information about the subsidy that would enable an interested party to determine whether it may be affected by the scheme, which at a minimum shall cover the purpose of the subsidy, the categories of beneficiary, the terms and conditions of eligibility for subsidy and the basis for the calculation of the subsidy (including any relevant conditions relating to subsidy ratios or amounts).

5. For the purposes of this Article, recovery of a subsidy is not required where a subsidy is granted on the basis of an Act of the Parliament of the United Kingdom, of an act of the European Parliament and of the Council of the European Union, or of an act of the Council of the European Union.

6. Nothing in this Article prevents a Party from choosing to provide additional situations where recovery is a remedy, beyond those specified in this Article, in accordance with its law.

7. The Parties recognise that recovery is an important remedial tool in any system of subsidy control. At the request of either Party, the Parties shall, within the Partnership Council consider additional or alternative mechanisms for recovery, as well as corresponding amendments to this Article. Within the Partnership Council, either Party may propose amendments to allow for different arrangements for their respective mechanisms for recovery. A Party must consider a proposal made by the other Party in good faith and agree to it, provided that this Party considers that it contains arrangements which represent at least as effective a means of delivering recovery as the existing mechanisms of the other Party. The Partnership Council may then make corresponding amendments to this Article.<sup>59</sup>

---

<sup>59</sup> The Parties note that the United Kingdom will implement a new system of subsidy control subsequent to the entry into force of this Agreement.

### Article 3.12: Remedial measures

1. A Party may deliver to the other Party a written request for information and consultations regarding a subsidy that it considers causes, or there is a serious risk that it will cause, a significant negative effect on trade or investment between the Parties. The requesting Party should provide in that request all relevant information to enable the Parties to find a mutually acceptable solution, including a description of the subsidy and the concerns of the requesting Party regarding its effect on trade or investment.
2. No later than 30 days from the date of delivery of the request the requested Party shall deliver a written response providing the requested information to the requesting Party, and the Parties shall enter into consultations, which shall be deemed concluded 60 days from the date of delivery of that request, unless the Parties agree otherwise. Such consultations, and in particular all information designated as confidential and positions taken by the Parties during consultations, shall be confidential, and shall be without prejudice to the rights of either Party in any further proceedings.
3. No earlier than 60 days from the date of delivery of the request referred to in paragraph 1, the requesting Party may unilaterally take appropriate remedial measures if there is evidence that a subsidy of the requested Party causes, or there is a serious risk that it will cause a significant negative effect on trade or investment between the Parties.
4. No earlier than 45 days from the date of delivery of the request referred to in paragraph 1, the requesting Party shall notify the requested Party of the remedial measures that it intends to take in accordance with paragraph 3. The requesting Party shall provide all relevant information in relation to the measures that it intends to take to enable the Parties to find a mutually acceptable solution. The requesting Party may not take those remedial measures earlier than 15 days from the date of delivery of the notification of those measures to the requested Party.
5. A Party's assessment of the existence of a serious risk of a significant negative effect shall be based on facts and not merely on allegation, conjecture or remote possibility. The change in circumstances that would create a situation in which the subsidy would cause such a significant negative effect must be clearly predictable.
6. A Party's assessment of the existence of a subsidy or of a significant negative effect on trade or investment between the Parties caused by the subsidy shall be based on reliable evidence and not merely on conjecture or remote possibility, and shall relate to identifiable goods, service suppliers or other economic actors, including, if relevant, in the case of subsidy schemes.
7. The Partnership Council may maintain an illustrative list of what would amount to a significant negative effect on trade or investment between the Parties within the meaning of paragraphs 1 and 3. This shall be without prejudice to the right of the Parties to take remedial measures.
8. The remedial measures taken pursuant to paragraph 3 shall be restricted to what is strictly necessary and proportionate in order to remedy the significant negative effect caused or to address the serious risk of such an effect. Priority shall be given to measures that will least disturb the functioning of this Agreement.
9. Within five days from the date on which the remedial measures referred to in paragraph 3 enter into effect and without having prior recourse to consultations in accordance with Article INST.13 [Consultations], the notified Party may request, in accordance with Article INST.14(2)

[Arbitration procedure], the establishment of an arbitration tribunal by means of a written request delivered to the requesting Party in order for the arbitration tribunal to decide whether:

- (a) a remedial measure taken by the requesting Party is inconsistent with paragraph 3 or 8;
- (b) the requesting Party did not participate in the consultations after the requested Party delivered the requested information and agreed to the holding of such consultations; or
- (c) there was a failure to take or notify a remedial measure in accordance with the time periods referred to in paragraph 3 or 4 respectively.

That request shall not have a suspensive effect on the remedial measures. Furthermore, the arbitration tribunal shall not assess the application by the Parties of Articles 3.4 [Principles] and 3.5 [Prohibited subsidies and subsidies subject to conditions].

10. The arbitration tribunal established following the request referred to in paragraph 9 shall conduct its proceedings in accordance with Article INST.34B [Special procedures for remedial measures and rebalancing] and deliver its final ruling within 30 days from its establishment.

11. In the case of a finding against the respondent Party, the respondent Party shall, at the latest 30 days from the date of delivery of the ruling of the arbitration tribunal, deliver a notification to the complaining Party of any measure that it has taken to comply with that ruling.

12. Following a finding against the respondent Party in the procedure referred to in paragraph 10, the complaining Party may request the arbitration tribunal, within 30 days from its ruling, to determine a level of suspension of obligations under this Agreement or a supplementing agreement not exceeding the level equivalent to the nullification or impairment caused by the application of the remedial measures, if it finds that the inconsistency of the remedial measures with paragraphs 3 or 8 is significant. The request shall propose a level of suspension of obligations in accordance with the principles set out in Article INST.34C [Suspension of obligations for the purposes of Article LPFS.3.12(12)[Remedial measures], Article FISH.9(5) and Article FISH.14(6)]. The complaining Party may suspend obligations under this Agreement or a supplementing agreement in accordance with the level of suspension of obligations determined by the arbitration tribunal. Such suspension shall not be applied sooner than 15 days following such ruling.

13. A Party shall not invoke the WTO Agreement or any other international agreement to preclude the other Party from taking measures pursuant to this Article, including where those measures consist in the suspension of obligations under this Agreement or under a supplementing agreement.

14. For the purposes of assessing whether imposing or maintaining remedial measures on imports of the same product is restricted to what is strictly necessary or proportionate for the purposes of this Article, a Party:

- (a) shall take into account countervailing measures applied or maintained pursuant to Article GOODS.17(3) [Trade Remedies] of Title IV [Trade in goods]; and
- (b) may take into account anti-dumping measures applied or maintained pursuant to Article GOODS.17(3) [Trade Remedies] of Title IV [Trade in goods].

15. A Party shall not apply simultaneously a remedial measure under this Article and a rebalancing measure under Article 9.4 [Rebalancing] to remedy the impact on trade or investment caused directly by the same subsidy.

16. If the Party against which remedial measures were taken does not submit a request pursuant to paragraph 9 of this Article within the time period laid down in that paragraph, that Party may initiate the arbitration procedure referred to in Article INST.14 [Arbitration procedure] to challenge a remedial measure on the grounds set out in paragraph 9 of this Article without having prior recourse to consultations in accordance with Article INST.13 [Consultations]. An arbitration tribunal shall treat the issue as a case of urgency for the purpose of Article INST.19 [Urgent proceedings].

17. For the purposes of the proceedings under paragraphs 9 and 16, in assessing whether a remedial measure is strictly necessary or proportionate, the arbitration tribunal shall pay due regard to the principles set out in paragraphs 5 and 6, as well as to paragraphs 13, 14 and 15.

#### Article 3.13: Dispute settlement

1. Subject to paragraphs 2 and 3, Title I [Dispute settlement] of Part Six [Dispute settlement and horizontal provisions] applies to disputes between the Parties concerning the interpretation and application of this Chapter, except for Articles 3.9 [Independent authority or body and cooperation] and 3.10 [Courts and tribunals].

2. An arbitration tribunal shall have no jurisdiction regarding:

- (a) an individual subsidy, including whether such a subsidy has respected the principles set out in paragraph 1 of Article 3.4 [Principles], other than with regard to the conditions set out in Article 3.5(2) [Unlimited state guarantees], (3) to (5) [Rescue and restructuring], (8) to (11) [Export subsidies] and (12) [Subsidies contingent upon the use of domestic content]; and
- (b) whether the recovery remedy within the meaning of Article 3.11 [Recovery] has been correctly applied in any individual case.

3. Title I [Dispute settlement] of Part Six [Dispute settlement and horizontal provisions] shall apply to Article 3.12 [Remedial measures] in accordance with that Article and Article INST.34B [Special procedures for remedial measures and rebalancing].

#### Chapter four: State-owned enterprises, enterprises granted special rights or privileges and designated monopolies

##### Article 4.1: Definitions

1. For the purposes of this Chapter, the following definitions apply:

- (a) "Arrangement" means the Arrangement on Officially Supported Export Credits, developed within the framework of the OECD or a successor undertaking, whether developed within or outside of the OECD framework, that has been adopted by at least 12 original WTO Members that were Participants to the Arrangement as of 1 January 1979;
- (b) "commercial activities" means activities, the end result of which is the production of a good or the supply of a service to be sold in the relevant market in quantities and at prices determined by an enterprise on the basis of the conditions of supply and demand, and which

are undertaken with an orientation towards profit-making; activities undertaken by an enterprise which operates on a non-profit basis or a cost-recovery basis are not activities undertaken with an orientation towards profit-making;

- (c) "commercial considerations" means considerations of price, quality, availability, marketability, transportation and other terms and conditions of purchase or sale, or other factors that would normally be taken into account in the commercial decisions of a privately owned enterprise operating according to market economy principles in the relevant business or industry;
- (d) "covered entity" means:
  - (i) a designated monopoly;
  - (ii) an enterprise granted special rights or privileges; or
  - (iii) a State-owned enterprise.
- (e) "designated monopoly" means an entity, including a consortium or a government agency, that, in a relevant market in the territory of a Party, is designated as the sole supplier or purchaser of a good or service, but does not include an entity that has been granted an exclusive intellectual property right solely by reason of such grant; in this context, designate means to establish or authorise a monopoly, or to expand the scope of a monopoly to cover an additional good or service;
- (f) "enterprise" means enterprise as defined in point (g) of Article SERVIN.1.2 [Definitions.];
- (g) "enterprise granted special rights or privileges" means any enterprise, public or private, to which a Party has granted special rights or privileges, in law or in fact;
- (h) "service supplied in the exercise of governmental authority" means a service supplied in the exercise of governmental authority as defined in GATS;
- (i) "special rights or privileges" means rights or privileges by which a Party designates or limits to two or more the number of enterprises authorised to supply a good or service, other than according to objective, proportional and non-discriminatory criteria, substantially affecting the ability of any other enterprise to supply the same good or service in the same geographical area or product market under substantially equivalent conditions;
- (j) "State-owned enterprise" means an enterprise in which a Party:
  - (i) directly owns more than 50 % of the share capital;
  - (ii) controls, directly or indirectly, the exercise of more than 50 % of the voting rights;
  - (iii) holds the power to appoint a majority of the members of the board of directors or any other equivalent management body; or
  - (iv) has the power to exercise control over the enterprise. For the establishment of control, all relevant legal and factual elements shall be taken into account on a case-by-case basis.

## Article 4.2: Scope

1. This Chapter applies to covered entities, at all levels of government, engaged in commercial activities. If a covered entity engages in both commercial and non-commercial activities, only the commercial activities are covered by this Chapter.
2. This Chapter does not apply to:
  - (a) covered entities when acting as procuring entities, as defined in each Party's Annexes 1 to 3 of Appendix 1 to the GPA and each Party's paragraph 1 of their respective sub-sections in section B2 of ANNEX PPROC-1: PUBLIC PROCUREMENT of Title X [Public procurement], conducting covered procurement as defined in Article PPROC.2(2) [Incorporation of certain provisions of the GPA and covered procurement] of Title X [Public procurement];
  - (b) any service supplied in the exercise of governmental authority.
3. This Chapter does not apply to a covered entity, if in any one of the three previous consecutive fiscal years the annual revenue derived from the commercial activities of the enterprise or monopoly concerned was less than 100 million Special Drawing Rights.
4. Article 4.5 [Non-discriminatory treatment and commercial considerations] does not apply to the supply of financial services by a covered entity pursuant to a government mandate, if that supply of financial services:
  - (a) supports exports or imports, provided that those services are:
    - i. not intended to displace commercial financing; or
    - ii. offered on terms no more favourable than those that could be obtained for comparable financial services in the commercial market; or
  - (b) supports private investment outside the territory of the Party, provided that those services are:
    - i. not intended to displace commercial financing; or
    - ii. offered on terms no more favourable than those that could be obtained for comparable financial services in the commercial market; or
  - (c) is offered on terms consistent with the Arrangement, if the supply of those services falls within the scope of the Arrangement.
5. Without prejudice to paragraph 3 of this Article, Article 4.5 [Non-discriminatory treatment and commercial considerations] does not apply to the following sectors: audio-visual services; national maritime cabotage<sup>60</sup>; and inland waterways transport, as set out in Article SERVIN 1.1(5) [Objective and scope]

---

<sup>60</sup> National maritime cabotage covers: for the Union, without prejudice to the scope of activities which may be considered as cabotage under the relevant national legislation, transportation of passengers or goods between a port or point located in a Member State of the Union and another port or point located in that same Member State of the Union, including on its continental shelf, as provided for in the United Nations



6. Article 4.5 [Non-discrimination and commercial considerations] does not apply to the extent that a covered entity of a Party makes purchases or sales of goods or services pursuant to:

- (a) any existing non-conforming measure that the Party maintains, continues, renews or amends in accordance with [Article SERVIN 2.7(1) [Non-conforming measures and exceptions] or Article SERVIN.3.6(1) [Non-conforming measures] as set out in its Schedules to ANNEXES SERVIN-1 and SERVIN-2, as applicable]; or
- (b) any non-conforming measure that the Party adopts or maintains with respect to sectors, subsectors, or activities in accordance with [Article SERVIN.2.7(2) [Non-conforming measures and exceptions] or Article SERVIN.3.6(2) [Non-conforming measures] as set out in its Schedules to ANNEXES SERVIN-1 and SERVIN-2], as applicable.

#### Article 4.3: Relationship with the WTO Agreement

The Parties affirm their rights and obligations under paragraphs 1 to 3 of Article XVII of GATT 1994, the Understanding on the Interpretation of Article XVII of the GATT 1994, as well as under paragraphs 1, 2 and 5 of Article VIII of GATS.

#### Article 4.4: General provisions

- 1. Without prejudice to the rights and obligations of each Party under this Chapter, nothing in this Chapter prevents a Party from establishing or maintaining a covered entity.
- 2. Neither Party shall require or encourage a covered entity to act in a manner inconsistent with this Chapter.

#### Article 4.5: Non-discriminatory treatment and commercial considerations

- 1. Each Party shall ensure that each of its covered entities, when engaging in commercial activities:
  - (a) acts in accordance with commercial considerations in its purchase or sale of a good or service, except to fulfil any terms of its public service mandate that are not inconsistent with points (b) or (c);
  - (b) in its purchase of a good or service:
    - i. accords to a good or service supplied by an enterprise of the other Party treatment no less favourable than it accords to a like good or a like service supplied by enterprises of the Party; and
    - ii. accords to a good or service supplied by a covered entity in the Party's territory treatment no less favourable than it accords to a like good or a like service supplied by enterprises of the Party in the relevant market in the Party's territory; and

---

Convention on the Law of the Sea, done at Montego Bay, on 10 December 1982 (the "United Nations Convention on the Law of the Sea"), and traffic originating and terminating in the same port or point located in a Member State of the Union; for the United Kingdom, transportation of passengers or goods between a port or point located in the United Kingdom and another port or point located in the United Kingdom, including on its continental shelf, as provided for in the United Nations Convention on the Law of the Sea, and traffic originating and terminating in the same port or point located in the United Kingdom.



- (c) in its sale of a good or service:
  - i. accords to an enterprise of the other Party treatment no less favourable than it accords to enterprises of the Party; and
  - ii. accords to a covered entity in the Party's territory, treatment no less favourable than it accords to enterprises of the Party in the relevant market in the Party's territory.<sup>61</sup>
- 2. Points \*(b) and (c) of paragraph 1 do not preclude a covered entity from:
  - (a) purchasing or supplying goods or services on different terms or conditions, including terms or conditions relating to price, provided that those different terms or conditions are in accordance with commercial considerations; or
  - (b) refusing to purchase or supply goods or services, provided that such refusal is made in accordance with commercial considerations.

#### Article 4.6: Regulatory framework

- 1. Each Party shall respect and make best use of relevant international standards including the OECD Guidelines on Corporate Governance of State-Owned Enterprises.
- 2. Each Party shall ensure that any regulatory body, and any other body exercising a regulatory function, that that Party establishes or maintains:
  - (a) is independent from, and is not accountable to, any of the enterprises regulated by that body; and
  - (b) in like circumstances, acts impartially with respect to all enterprises regulated by that body, including covered entities; the impartiality with which the body exercises its regulatory functions is to be assessed by reference to a general pattern or practice of that body.

For those sectors in which the Parties have agreed to specific obligations relating to such a body in this Agreement, the relevant provisions of this Agreement shall prevail.

- 3. Each Party shall apply its laws and regulations to covered entities in a consistent and non-discriminatory manner.

#### Article 4.7: Information exchange

- 1. A Party which has reason to believe that its interests under this Chapter are being adversely affected by the commercial activities of an entity of the other Party may request the other Party in writing to provide information on the commercial activities of that entity, related to the carrying out of the provisions of this Chapter in accordance with paragraph 2.
- 2. Provided that the request referred to in paragraph 1 includes an explanation of how the activities of the entity may be affecting the interests of the requesting Party under this Chapter and

---

<sup>61</sup> For greater certainty, this paragraph shall not apply with respect to the purchase or sale of shares, stock or other forms of equity by a covered entity as a means of its equity participation in another enterprise.

indicates which of the following categories of information is or are to be provided, the requested Party shall provide the information so requested:

- (a) the ownership and the voting structure of the entity, indicating the cumulative percentage of shares and the percentage of voting rights that the requested Party and its covered entities cumulatively have in the entity;
- (b) a description of any special shares or special voting or other rights that the requested Party or its covered entities hold, to the extent that such rights are different from those attached to the general common shares of the entity;
- (c) a description of the organisational structure of the entity and the composition of its board of directors or of any equivalent body;
- (d) a description of the government departments or public bodies which regulate or monitor the entity, a description of the reporting requirements imposed on it by those departments or public bodies, and the rights and practices of those departments or public bodies with respect to the appointment, dismissal or remuneration of senior executives and members of its board of directors or any equivalent body;
- (e) the annual revenue and total assets of the entity over the most recent three-year period for which information is available;
- (f) any exemptions, immunities and related measures from which the entity benefits under the laws and regulations of the requested Party;
- (g) any additional information regarding the entity that is publicly available, including annual financial reports and third-party audits.

3. Paragraphs 1 and 2 do not require a Party to disclose confidential information the disclosure of which would be inconsistent with its laws and regulations, would impede law enforcement, or otherwise would be contrary to the public interest or would prejudice the legitimate commercial interests of particular enterprises.

4. If the requested information is not available, the requested Party shall provide to the requesting Party, in writing, the reasons why that information is not available.

## Chapter five: Taxation

### Article 5.1: Good governance

The Parties recognise and commit to implementing the principles of good governance in the area of taxation, in particular the global standards on tax transparency and exchange of information and fair tax competition. The Parties reiterate their support for the OECD Base Erosion and Profit Shifting (BEPS) Action Plan and affirm their commitment to implementing the OECD minimum standards against BEPS. The Parties will promote good governance in tax matters, improve international cooperation in the area of taxation and facilitate the collection of tax revenues.

## Article 5.2: Taxation standards

1. A Party shall not weaken or reduce the level of protection provided for in its legislation at the end of the transition period below the level provided for by the standards and rules which have been agreed in the OECD at the end of the transition period, in relation to:

- (a) the exchange of information, whether upon request, spontaneously or automatically, concerning financial accounts, cross-border tax rulings, country-by-country reports between tax administrations, and potential cross-border tax planning arrangements;
- (b) rules on interest limitation, controlled foreign companies and hybrid mismatches.

2. A Party shall not weaken or reduce the level of protection provided for in its legislation at the end of the transition period in respect of public country-by-country reporting by credit institutions and investment firms, other than small and non-interconnected investment firms.

## Article 5.3: Dispute settlement

This Chapter shall not be subject to dispute settlement under Title I [Dispute settlement] of Part Six [Dispute settlement and horizontal provisions].

## Chapter six: Labour and social standards

### Article 6.1: Definition

1. For the purposes of this Chapter, “labour and social levels of protection” means the levels of protection provided overall in a Party’s law and standards<sup>62</sup>, in each of the following areas:

- (a) fundamental rights at work;
- (b) occupational health and safety standards;
- (c) fair working conditions and employment standards;
- (d) information and consultation rights at company level; or
- (e) restructuring of undertakings.

2. For the Union, “labour and social levels of protection” means labour and social levels of protection that are applicable to and in, and are common to, all Member States.

### Article 6.2: Non-regression from levels of protection

1. The Parties affirm the right of each Party to set its policies and priorities in the areas covered by this Chapter, to determine the labour and social levels of protection it deems appropriate and to adopt or modify its law and policies in a manner consistent with each Party's international commitments, including those under this Chapter.

---

<sup>62</sup> For greater certainty, this Chapter and Article 9.4 [Rebalancing] do not apply to the Parties’ law and standards relating to social security and pensions.

2. A Party shall not weaken or reduce, in a manner affecting trade or investment between the Parties, its labour and social levels of protection below the levels in place at the end of the transition period, including by failing to effectively enforce its law and standards.

3. The Parties recognise that each Party retains the right to exercise reasonable discretion and to make bona fide decisions regarding the allocation of labour enforcement resources with respect to other labour law determined to have higher priority, provided that the exercise of that discretion, and those decisions, are not inconsistent with its obligations under this Chapter.

4. The Parties shall continue to strive to increase their respective labour and social levels of protection referred to in this Chapter.

#### Article 6.3: Enforcement

For the purposes of enforcement as referred to in Article 6.2 [Non-regression from levels of protection] each Party shall have in place and maintain a system for effective domestic enforcement and, in particular, an effective system of labour inspections in accordance with its international commitments relating to working conditions and the protection of workers; ensure that administrative and judicial proceedings are available that allow public authorities and individuals with standing to bring timely actions against violations of the labour law and social standards; and provide for appropriate and effective remedies, including interim relief, as well as proportionate and dissuasive sanctions. In the domestic implementation and enforcement of Article 6.2 [Non-regression from levels of protection], each Party shall respect the role and autonomy of the social partners at a national level, where relevant, in line with applicable law and practice.

#### Article 6.4: Dispute settlement

1. The Parties shall make all efforts through dialogue, consultation, exchange of information and cooperation to address any disagreement on the application of this Chapter.

2. By way of derogation from Title I [Dispute settlement] of Part Six [Dispute settlement and horizontal provisions], in the event of a dispute between the Parties regarding the application of this Chapter, the Parties shall have recourse exclusively to the procedures established under Articles 9.1 [Consultations], 9.2 [Panel of experts] and 9.3 [Panel of experts for non-regression areas] of this Title.

### Chapter seven : Environment and climate

#### Article 7.1: Definitions

1. For the purposes of this Chapter, “environmental levels of protection” means the levels of protection provided overall in a Party’s law which have the purpose of protecting the environment, including the prevention of a danger to human life or health from environmental impacts, including in each of the following areas:

- (a) industrial emissions;
- (b) air emissions and air quality;
- (c) nature and biodiversity conservation;
- (d) waste management;

- (e) the protection and preservation of the aquatic environment;
  - (f) the protection and preservation of the marine environment;
  - (g) the prevention, reduction and elimination of risks to human health or the environment arising from the production, use, release or disposal of chemical substances; or
  - (h) the management of impacts on the environment from agricultural or food production, notably through the use of antibiotics and decontaminants.
2. For the Union, “environmental levels of protection” means environmental levels of protection that are applicable to and in, and are common to, all Member States.
3. For the purposes of this Chapter, “climate level of protection” means the level of protection with respect to emissions and removals of greenhouse gases and the phase-out of ozone depleting substances. With regard to greenhouse gases, this means:
- (a) for the Union, the 40 % economy-wide 2030 target, including the Union’s system of carbon pricing;
  - (b) for the United Kingdom, the United Kingdom’s economy-wide share of this 2030 target, including the United Kingdom’s system of carbon pricing.

#### Article 7.2: Non-regression from levels of protection

1. The Parties affirm the right of each Party to set its policies and priorities in the areas covered by this Chapter, to determine the environmental levels of protection and climate level of protection it deems appropriate and to adopt or modify its law and policies in a manner consistent with each Party's international commitments, including those under this Chapter.
2. A Party shall not weaken or reduce, in a manner affecting trade or investment between the Parties, its environmental levels of protection or its climate level of protection below the levels that are in place at the end of the transition period, including by failing to effectively enforce its environmental law or climate level of protection.
3. The Parties recognise that each Party retains the right to exercise reasonable discretion and to make bona fide decisions regarding the allocation of environmental enforcement resources with respect to other environmental law and climate policies determined to have higher priorities, provided that the exercise of that discretion, and those decisions, are not inconsistent with its obligations under this Chapter.
4. For the purposes of this Chapter, insofar as targets are provided for in a Party’s environmental law in the areas listed in Article 7.1 [Definitions], they are included in a Party’s environmental levels of protection at the end of the transition period. These targets include those whose attainment is envisaged for a date that is subsequent to the end of the transition period. This paragraph shall also apply to ozone depleting substances.
5. The Parties shall continue to strive to increase their respective environmental levels of protection or their respective climate level of protection referred to in this Chapter.

### Article 7.3: Carbon pricing

1. Each Party shall have in place an effective system of carbon pricing as of 1 January 2021.
2. Each system shall cover greenhouse gas emissions from electricity generation, heat generation, industry and aviation.
3. The effectiveness of the Parties' respective carbon pricing systems shall uphold the level of protection provided for by Article 7.2 [Non-regression from levels of protection]
4. By way of derogation from paragraph 2, aviation shall be included within two years at the latest, if not included already. The scope of the Union system of carbon pricing shall cover departing flights from the European Economic Area to the United Kingdom.
5. Each Party shall maintain their system of carbon pricing insofar as it is an effective tool for each Party in the fight against climate change and shall in any event uphold the level of protection provided for by Article 7.2 [Non-regression from levels of protection]
6. The Parties shall cooperate on carbon pricing. They shall give serious consideration to linking their respective carbon pricing systems in a way that preserves the integrity of these systems and provides for the possibility to increase their effectiveness.

### Article 7.4: Environmental and climate principles

1. Taking into account the fact that the Union and the United Kingdom share a common biosphere in respect of cross-border pollution, each Party commits to respecting the internationally recognised environmental principles to which it has committed, such as in the Rio Declaration on Environment and Development, adopted at Rio de Janeiro on 14 June 1992 (the "1992 Rio Declaration on Environment and Development") and in multilateral environmental agreements, including in the United Nations Framework Convention on Climate Change, done at New York on 9 May 1992 (the "UNFCCC") and the and the Convention on Biological Diversity, done at Rio de Janeiro on 5 June 1992 (the "Convention on Biological Diversity"), in particular:
  - (a) the principle that environmental protection should be integrated into the making of policies, including through impact assessments;
  - (b) the principle of preventative action to avert environmental damage;
  - (c) the precautionary approach referred to in Article 1.2(2) [Right to regulate, precautionary approach and scientific and technical information];
  - (d) the principle that environmental damage should as a priority be rectified at source; and
  - (e) the polluter pays principle.
2. The Parties reaffirm their respective commitments to procedures for evaluating the likely impact of a proposed activity on the environment, and where specified projects, plans and programmes are likely to have significant environmental, including health, effects, this includes an environmental impact assessment or a strategic environmental assessment, as appropriate.
3. These procedures shall comprise, where appropriate and in accordance with a Party's laws, the determination of the scope of an environmental report and its preparation, the carrying out of

public participation and consultations and the taking into account of the environmental report and the results of the public participation and consultations in the consented project, or adopted plan or programme.

#### Article 7.5: Enforcement

1. For the purposes of enforcement as referred to in Article 7.2 [Non-regression from levels of protection], each Party shall, in accordance with its law, ensure that:
  - (a) domestic authorities competent to enforce the relevant law with regard to environment and climate give due consideration to alleged violations of such law that come to their attention; those authorities shall have adequate and effective remedies available to them, including injunctive relief as well as proportionate and dissuasive sanctions, if appropriate; and
  - (b) national administrative or judicial proceedings are available to natural and legal persons with a sufficient interest to bring actions against violations of such law and to seek effective remedies, including injunctive relief, and that the proceedings are not prohibitively costly and are conducted in a fair, equitable and transparent way.

#### Article 7.6: Cooperation on monitoring and enforcement

The Parties shall ensure that the European Commission and the supervisory bodies of the United Kingdom regularly meet with each other and co-operate on the effective monitoring and enforcement of the law with regard to environment and climate as referred to in Article 7.2 [Non-regression from levels of protection].

#### Article 7.7: Dispute settlement

1. The Parties shall make all efforts through dialogue, consultation, exchange of information and cooperation to address any disagreement on the application of this Chapter.
2. By way of derogation from Title I of Part Six [Dispute settlement and horizontal provisions], in the event of a dispute between the Parties regarding the application of this Chapter, the Parties shall have recourse exclusively to the procedures established under Articles 9.1 [Consultations], 9.2 [Panel of experts] and 9.3 [Panel of experts for non-regression areas] of this Title.

### Chapter eight : Other instruments for trade and sustainable development

#### Article 8.1: Context and objectives

1. The Parties recall the Agenda 21 and the 1992 Rio Declaration on Environment and Development, the Johannesburg Plan of Implementation of the World Summit on Sustainable Development of 2002, the International Labour Organization (ILO) Declaration on Social Justice for a Fair Globalization, adopted at Geneva on 10 June 2008 by the International Labour Conference at its 97<sup>th</sup> Session (the “2008 ILO Declaration on Social Justice for a Fair Globalization”), the Outcome Document of the UN Conference on Sustainable Development of 2012 entitled "The Future We Want", endorsed by the UN General Assembly Resolution 66/288 adopted on 27 July 2012, and the UN 2030 Agenda for Sustainable Development, adopted by the UN General Assembly Resolution 70/1 on 25 September 2015 and its Sustainable Development Goals.
2. In light of paragraph 1, the objective of this Chapter is to enhance the integration of sustainable development, notably its labour and environmental dimensions, in the Parties' trade and

investment relationship and in this respect to complement the commitments of the Parties under Chapter 6 [Labour and social standards] and Chapter 7 [Environment and climate].

#### Article 8.2: Transparency

1. The Parties stress the importance of ensuring transparency as a necessary element to promote public participation and of making information public within the context of this Chapter. In accordance with their laws and regulations, the provisions of this Chapter, of Chapter IX [Transparency] and of Chapter X [Good Regulatory Practices], each Party shall:

- (a) ensure that any measure of general application pursuing the objectives of this Chapter is administered in a transparent manner, including by providing the public with reasonable opportunities and sufficient time to comment, and by publishing such measures;
- (b) ensure that the general public is given access to relevant environmental information held by or for public authorities, as well as ensuring the active dissemination of that information to the general public by electronic means;
- (c) encourage public debate with and among non-state actors as regards the development and definition of policies that may lead to the adoption of law relevant to this Chapter by its public authorities; this includes, in relation to the environment, public participation in projects, plans and programmes; and
- (d) promote public awareness of its laws and standards relevant to this Chapter, as well as enforcement and compliance procedures, by taking steps to further the knowledge and understanding of the public; in relation to labour laws and standards, this includes workers, employers and their representatives.

#### Article 8.3: Multilateral labour standards and agreements

1. The Parties affirm their commitment to promoting the development of international trade in a way that is conducive to decent work for all, as expressed in the 2008 ILO Declaration on Social Justice for a Fair Globalization.

2. In accordance with the ILO Constitution and the ILO Declaration on Fundamental Principles and Rights at Work and its Follow-up, adopted at Geneva on 18 June 1998 by the International Labour Conference at its 86th Session, each Party commits to respecting, promoting and effectively implementing the internationally recognised core labour standards, as defined in the fundamental ILO Conventions, which are:

- (a) freedom of association and the effective recognition of the right to collective bargaining;
- (b) the elimination of all forms of forced or compulsory labour;
- (c) the effective abolition of child labour; and
- (d) the elimination of discrimination in respect of employment and occupation.

3. Each Party shall make continued and sustained efforts to ratify the fundamental ILO Conventions if they have not yet done so.



4. The Parties shall exchange information, regularly and as appropriate, on the respective situations and progress of the Member States and of the United Kingdom with regard to the ratification of ILO Conventions or protocols classified as up-to-date by the ILO and of other relevant international instruments.

5. Each Party commits to implementing all the ILO Conventions that the United Kingdom and the Member States of the Union have respectively ratified and the different provisions of the European Social Charter that, as members of the Council of Europe, the Member States of the Union and the United Kingdom have respectively accepted<sup>63</sup>.

6. Each Party shall continue to promote, through its laws and practices, the ILO Decent Work Agenda as set out in the 2008 ILO Declaration on Social Justice for a Fair Globalization (the "ILO Decent Work Agenda") and in accordance with relevant ILO Conventions, and other international commitments, in particular with regard to:

- (a) decent working conditions for all, with regard to, inter alia, wages and earnings, working hours, maternity leave and other conditions of work;
- (b) health and safety at work, including the prevention of occupational injury or illness and compensation in cases of such injury or illness; and
- (c) non-discrimination in respect of working conditions, including for migrant workers.

7. Each Party shall protect and promote social dialogue on labour matters among workers and employers, and their respective organisations, and with relevant government authorities.

8. The Parties shall work together on trade-related aspects of labour policies and measures, including in multilateral fora, such as the ILO, as appropriate. Such cooperation may cover inter alia:

- (a) trade-related aspects of implementation of fundamental, priority and other up-to-date ILO Conventions;
- (b) trade-related aspects of the ILO Decent Work Agenda, including on the interlinkages between trade and full and productive employment, labour market adjustment, core labour standards, decent work in global supply chains, social protection and social inclusion, social dialogue and gender equality;
- (c) the impact of labour law and standards on trade and investment, or the impact of trade and investment law on labour;
- (d) dialogue and information-sharing on the labour provisions in the context of their respective trade agreements, and the implementation thereof; and
- (e) any other form of cooperation deemed appropriate.

---

<sup>63</sup> Each Party maintains its right to determine its priorities, policies and the allocation of resources in the effective implementation of the ILO Conventions and the relevant provisions of the European Social Charter in a manner consistent with its international commitments, including those under this Title. The Council of Europe, established in 1949, adopted the European Social Charter in 1961, which was revised in 1996. All Member States have ratified the European Social Charter in its original or revised version. For the United Kingdom, the reference to the European Social Charter in paragraph 5 refers to the original 1961 version.

9. The Parties shall consider any views provided by representatives of workers, employers, and civil society organisations when identifying areas of cooperation and when carrying out cooperative activities.

#### Article 8.4: Multilateral environmental agreements

1. The Parties recognise the importance of the UN Environment Assembly (UNEA), of the UN Environment Programme (UNEP) and multilateral environmental governance and agreements as a response of the international community to global or regional environmental challenges and stress the need to enhance the mutual supportiveness between trade and environment policies, rules and measures.

2. In light of paragraph 1, each Party commits to effectively implementing the multilateral environmental agreements, protocols and amendments that it has ratified in its law and practices.

3. The Parties shall regularly and as appropriate exchange information on:

- (a) their respective situations as regards the ratification and implementation of multilateral environmental agreements, including their protocols and amendments;
- (b) on-going negotiations of new multilateral environmental agreements; and
- (c) each Party's respective views on becoming a party to additional multilateral environmental agreements.

4. The Parties reaffirm the right of each Party to adopt or maintain measures to further the objectives of multilateral environmental agreements to which it is a party. The Parties recall that measures adopted or enforced to implement such multilateral environmental agreements may be justified under Article EXC.1 [General exceptions] of Title XII [Exceptions].

5. The Parties shall work together on trade-related aspects of environmental policies and measures, including in multilateral fora, such as the UN High-level Political Forum for Sustainable Development, UN Environment, UNEA, multilateral environmental agreements, the International Civil Aviation Organization (ICAO) or the WTO as appropriate. Such cooperation may cover inter alia:

- (a) initiatives on sustainable production and consumption, including those aimed at promoting a circular economy and green growth and pollution abatement;
- (b) initiatives to promote environmental goods and services, including by addressing related tariff and non-tariff barriers;
- (c) the impact of environmental law and standards on trade and investment; or the impact of trade and investment law on the environment;
- (d) the implementation of Annex 16 to the Convention on International Civil Aviation, done at Chicago on 7 December 1944, and other measures to reduce the environmental impact of aviation, including in the area of air traffic management; and
- (e) other trade-related aspects of multilateral environmental agreements, including their protocols, amendments and implementation.

6. Cooperation pursuant to paragraph 5 may include technical exchanges, exchanges of information and best practices, research projects, studies, reports, conferences and workshops.

7. The Parties will consider views or input from the public and interested stakeholders for the definition and implementation of their cooperation activities, and they may involve such stakeholders further in those activities, as appropriate.

#### Article 8.5: Trade and climate change

1. The Parties recognise the importance of taking urgent action to combat climate change and its impacts, and the role of trade and investment in pursuing that objective, in line with the UNFCCC, the purpose and goals of the Paris Agreement adopted at Paris on 12 December 2015 by the Conference of the Parties to the United Nations Framework Convention on Climate Change at its 21st session (the “Paris Agreement”), and with other multilateral environmental agreements and multilateral instruments in the area of climate change.

2. In light of paragraph 1, each Party:

- (a) commits to effectively implementing the UNFCCC, and the Paris Agreement adopted thereunder of which one principal aim is strengthening the global response to climate change and holding the increase in global average temperature to well below 2°C above pre-industrial levels and pursuing efforts to limit the temperature increase to 1.5°C above pre-industrial levels;
- (b) shall promote the mutual supportiveness of trade and climate policies and measures thereby contributing to the transition to a low greenhouse gas emission, resource-efficient economy and to climate-resilient development;
- (c) shall facilitate the removal of obstacles to trade and investment in goods and services of particular relevance for climate change mitigation and adaptation, such as renewable energy, energy efficient products and services, for instance through addressing tariff and non-tariff barriers or through the adoption of policy frameworks conducive to the deployment of the best available solutions.

3. The Parties shall work together to strengthen their cooperation on trade-related aspects of climate change policies and measures bilaterally, regionally and in international fora, as appropriate, including in the UNFCCC, the WTO, the Montreal Protocol on Substances that Deplete the Ozone Layer, done at Montreal on 26 August 1987 (the “Montreal Protocol”), the International Maritime Organisation (IMO) and the International Civil Aviation organization (ICAO). Such cooperation may cover inter alia:

- (a) policy dialogue and cooperation regarding the implementation of the Paris Agreement, such as on means to promote climate resilience, renewable energy, low-carbon technologies, energy efficiency, sustainable transport, sustainable and climate-resilient infrastructure development, emissions monitoring, international carbon markets;
- (b) supporting the development and adoption of ambitious and effective greenhouse gas emissions reduction measures by the IMO to be implemented by ships engaged in international trade;
- (c) supporting the development and adoption of ambitious and effective greenhouse gas emissions reduction measures by the ICAO;

- (d) supporting an ambitious phase-out of ozone depleting substances and phase-down of hydrofluorocarbons under the Montreal Protocol through measures to control their production, consumption and trade; the introduction of environmentally friendly alternatives to them; the updating of safety and other relevant standards as well as by combating the illegal trade of substances regulated by the Montreal Protocol.

#### Article 8.6: Trade and biological diversity

1. The Parties recognise the importance of conserving and sustainably using biological diversity and the role of trade in pursuing these objectives, including by promoting sustainable trade or controlling or restricting trade in endangered species, in line with the relevant multilateral environmental agreements to which they are party, and the decisions adopted thereunder, notably the Convention on Biological Diversity and its protocols, and the Convention on International Trade in Endangered Species of Wild Fauna and Flora, done at Washington D.C. on 3 March 1973 (“CITES”).

2. In light of paragraph 1, each Party shall:

- (a) implement effective measures to combat illegal wildlife trade, including with respect to third countries, as appropriate;
- (b) promote the use of CITES as an instrument for conservation and sustainable management of biodiversity, including through the inclusion of animal and plant species in the Appendices to CITES where the conservation status of that species is considered at risk because of international trade;
- (c) encourage trade in products derived from a sustainable use of biological resources and contributing to the conservation of biodiversity;
- (d) continue to take measures to conserve biological diversity when it is subject to pressures linked to trade and investment, in particular through measures to prevent the spread of invasive alien species.

3. The Parties shall work together on trade-related matters of relevance to this Article, including in multilateral fora, such as CITES and the Convention on Biological Diversity, as appropriate. Such cooperation may cover inter alia: trade in wildlife and natural resource-based products, the valuation and assessment of ecosystems and related services, and the access to genetic resources and the fair and equitable sharing of benefits arising from their utilisation consistent with the Nagoya Protocol on Access to Genetic Resources and the Fair and Equitable Sharing of Benefits Arising from their Utilization to the Convention on Biological Diversity, adopted in Nagoya on 29 October 2010.

#### Article 8.7: Trade and forests

1. The Parties recognise the importance of conservation and sustainable forest management for providing environmental functions and economic and social opportunities for present and future generations, and the role of trade in pursuing that objective.

2. In light of paragraph 1 and in a manner consistent with their international obligations, each Party shall:

- (a) continue to implement measures to combat illegal logging and related trade, including with respect to third countries, as appropriate, and to promote trade in legally harvested forest products;
  - (b) promote the conservation and sustainable management of forests and trade and consumption of timber and timber products harvested in accordance with the law of the country of harvest and from sustainably managed forests; and
  - (c) exchange information with the other Party on trade-related initiatives on sustainable forest management, forest governance and on the conservation of forest cover and cooperate to maximise the impact and mutual supportiveness of their respective policies of mutual interest.
3. The Parties shall work together to strengthen their cooperation on trade-related aspects of sustainable forest management, the conservation of forest cover and illegal logging, including in multilateral fora, as appropriate.

#### Article 8.8: Trade and sustainable management of marine biological resources and aquaculture

1. The Parties recognise the importance of conserving and sustainably managing marine biological resources and ecosystems as well as of promoting responsible and sustainable aquaculture, and the role of trade in pursuing those objectives.
2. In light of paragraph 1, each Party:
- (a) commits to acting consistently and complying, as appropriate, with the relevant UN and Food and Agriculture Organization (“FAO”) agreements, the United Nations Convention on the Law of the Sea, the Agreement for the Implementation of the Provisions of the United Nations Convention on the Law of the Sea of 10 December 1982 relating to the Conservation and Management of Straddling Fish Stocks and Highly Migratory Fish Stocks, done at New York on 4 August 1995, the FAO Agreement to Promote Compliance with International Conservation and Management Measures by Fishing Vessels on the High Seas, done at Rome on 24 November 1993, the FAO Code of Conduct for Responsible Fisheries and the FAO Agreement on Port State Measures to Prevent, Deter and Eliminate Illegal, Unreported and Unregulated (“IUU”) fishing, approved at Rome on 22 November 2009 at the 36<sup>th</sup> Session of the FAO Conference, and to participating in FAO’s initiative on the Global Record of Fishing Vessels, Refrigerated Transport Vessels and Supply Vessels;
  - (b) shall promote sustainable fisheries and good fisheries governance by participating actively in the work of relevant international organisations or bodies to which they are members, observers, or cooperating non-contracting parties, including the Regional Fisheries Management Organizations (RFMOs) by means of, where applicable, effective monitoring, control or enforcement of the RFMOs’ resolutions, recommendations or measures; the implementation of their catch documentation or certification schemes, and port state measures;
  - (c) shall adopt and maintain their respective effective tools to combat IUU fishing, including measures to exclude the products of IUU fishing from trade flows, and cooperate to that end;
  - (d) shall promote the development of sustainable and responsible aquaculture, including with regard to the implementation of the objectives and principles contained in the FAO Code of Conduct for Responsible Fisheries, as appropriate.

3. The Parties shall work together on conservation and trade-related aspects of fishery and aquaculture policies and measures, including in the WTO, RFMOs and other multilateral fora, as appropriate, with the aim of promoting sustainable fishing and aquaculture practices and trade in fish products from sustainably managed fisheries and aquaculture operations.

4. This Article is without prejudice to the provisions of Heading V [Fisheries] of Part Two.

#### Article 8.9: Trade and investment favouring sustainable development

1. The Parties confirm their commitment to enhance the contribution of trade and investment to the goal of sustainable development in its economic, social and environmental dimensions.

2. Pursuant to paragraph 1, the Parties shall continue to promote:

- (a) trade and investment policies that support the four strategic objectives of the ILO Decent Work Agenda, consistent with the 2008 ILO Declaration on Social Justice for a Fair Globalization, including the minimum living wage, health and safety at work, and other aspects related to working conditions;
- (b) trade and investment in environmental goods and services, such as renewable energy and energy efficient products and services, including through addressing related non-tariff barriers or through the adoption of policy frameworks conducive to the deployment of the best available solutions;
- (c) trade in goods and services that contribute to enhanced social conditions and environmentally sound practices, including those subject to voluntary sustainability assurance schemes such as fair and ethical trade schemes and eco-labels; and
- (d) cooperation in multilateral fora on issues referred to in this Article.

3. The Parties recognise the importance of addressing specific sustainable development issues by reviewing, monitoring and assessing the potential economic, social and environmental impacts of possible actions, taking account of the views of stakeholders.

#### Article 8.10: Trade and responsible supply chain management

1. The Parties recognise the importance of responsible management of supply chains through responsible business conduct and corporate social responsibility practices and the role of trade in pursuing this objective.

2. In light of paragraph 1, each Party shall:

- (a) encourage corporate social responsibility and responsible business conduct, including by providing supportive policy frameworks that encourage the uptake of relevant practices by businesses; and
- (b) support the adherence, implementation, follow-up and dissemination of relevant international instruments, such as the OECD Guidelines for Multinational Enterprises, the ILO Tripartite Declaration of Principles concerning Multinational Enterprises and Social Policy, the UN Global Compact, and the UN Guiding Principles on Business and Human Rights.

3. The Parties recognise the utility of international sector-specific guidelines in the area of corporate social responsibility and responsible business conduct and shall encourage joint work in this regard. In respect of the OECD Due Diligence Guidance for responsible supply chains of minerals from conflict-affected and high-risk areas and its supplements, the Parties shall also implement measures to promote the uptake of that Guidance.

4. The Parties shall work together to strengthen their cooperation on trade-related aspects of issues covered by this Article, including in multilateral fora, as appropriate, inter alia through the exchange of information, best practices and outreach initiatives.

#### Article 8.11: Dispute settlement

1. The Parties shall make all efforts through dialogue, consultation, exchange of information and cooperation to address any disagreement on the application of this Chapter.

2. By way of derogation from Title I [Dispute settlement] of Part Six [Dispute settlement and horizontal provisions], in the event of a dispute between the Parties regarding the application of this Chapter, the Parties shall have recourse exclusively to the procedures established under Article 9.1 [Consultations] and Article 9.2 [Panel of experts].

#### Chapter nine: Horizontal and institutional provisions

##### Article 9.1: Consultations

1. A Party may request consultations with the other Party regarding any matter arising under Article 1.1(3) [Principles and objectives] of Chapter 1 [General provisions], and Chapters 6 [Labour and social standards], 7 [Environment and climate], and 8 [Other instruments for trade and sustainable development] by delivering a written request to the other Party. The complaining Party shall specify in its written request the reasons and basis for the request, including identification of the measures at issue, specifying the provisions it considers applicable. Consultations must commence promptly after a Party delivers a request for consultations and in any event not later than 30 days after the date of delivery of the request, unless the Parties agree to a longer period.

2. The Parties shall enter into consultations with the aim of reaching a mutually satisfactory resolution of the matter. During consultations, each Party shall provide the other Party with sufficient information in its possession to allow a full examination of the matters raised. Each Party shall endeavour to ensure the participation of personnel of their competent authorities who have expertise in the matter subject to the consultations.

3. In matters relating to the multilateral agreements or instruments referred to in Article 1.1(3) [Principle and objectives], Chapters 6 [Labour and social standards], 7 [Environment and climate], and 8 [Other instruments for trade and sustainable development] the Parties shall take into account available information from the ILO or relevant bodies or organisations established under multilateral environmental agreements. Where relevant, the Parties shall jointly seek advice from such organisations or their bodies, or any other expert or body they deem appropriate.

4. Each Party may seek, when appropriate, the views of the domestic advisory groups referred to in Article INST.7 [Domestic advisory groups] or other expert advice.

5. Any resolution reached by the Parties shall be made available to the public.



## Article 9.2: Panel of experts

1. For any matter that is not satisfactorily addressed through consultations under Article 9.1 [Consultations], a Party may, after 90 days from the receipt of a request for consultations under that Article, request that a panel of experts be convened to examine that matter, by delivering a written request to the other Party. The request shall identify the measure at issue, specify and explain how that measure does not conform with the provisions of the relevant Chapter or Chapters in a manner sufficient to present the complaint clearly.

2. The panel of experts shall be composed of three panellists.

3. The Trade Specialised Committee on the Level Playing Field for Open and Fair Competition and Sustainable Development shall, at its first meeting after the entry into force of this Agreement, establish a list of at least 15 individuals who are willing and able to serve as panellists. Each Party shall name at least five individuals to the list to serve as panellists. The Parties shall also name at least five individuals who are not nationals of either Party and who are willing and able to serve as chairperson of a panel of experts. The Trade Specialised Committee on the Level Playing Field for Open and Fair Competition and Sustainable Development shall ensure that the list is kept up to date and that the number of experts is maintained at a minimum of 15 individuals.

4. The experts proposed as panellists must have specialised knowledge or expertise in labour or environmental law, other issues addressed in the relevant Chapter or Chapters, or in the resolution of disputes arising under international agreements. They must serve in their individual capacities and not take instructions from any organisation or government with regard to matters related to the dispute. They must not be affiliated with or take instructions from either Party. They shall not be persons who are members, officials or other servants of the Union institutions, of the Government of a Member State, of the Government of the United Kingdom.

5. Unless the Parties agree otherwise within five days from the date of establishment of the panel of experts, the terms of reference shall be:

*“to examine, in the light of the relevant provisions, the matter referred to in the request for the establishment of the panel of experts, and to deliver a report, in accordance with this Article that makes findings on the conformity of the measure with the relevant provisions.”*

6. In respect of matters related to multilateral standards or agreements covered in this Title, the panel of experts should seek information from the ILO or relevant bodies established under those agreements, including any pertinent available interpretative guidance, findings or decisions adopted by the ILO and those bodies.

7. The panel of experts may request and receive written submissions or any other information from persons with relevant information or specialised knowledge.

8. The panel of experts shall make available such information to each Party allowing them to submit their comments within 20 days of its receipt.

9. The panel of experts shall issue to the Parties an interim report and a final report setting out the findings of fact, its determinations on the matter including as to whether the responding Party has conformed with its obligations under the relevant Chapter or Chapters and the rationale behind any findings and determinations that it makes. For greater certainty, the Parties share the understanding that if the Panel makes recommendations in its report, the responding Party does not need to follow these recommendations in ensuring conformity with the Agreement.



10. The panel of experts shall deliver to the Parties the interim report within 100 days after the date of establishment of the panel of experts. When the panel of experts considers that this deadline cannot be met, the chairperson of the panel of experts shall notify the Parties in writing, stating the reasons for the delay and the date on which the panel of experts plans to deliver its interim report. The panel of experts shall, under no circumstances, deliver its interim report later than 125 days after the date of establishment of the panel of experts.

11. Each Party may deliver to the panel of experts a reasoned request to review particular aspects of the interim report within 25 days of its delivery. A Party may comment on the other's Party's request within 15 days of the delivery of the request.

12. After considering those comments, the panel of experts shall prepare the final report. If no request to review particular aspects of the interim report is delivered within the time period referred to in paragraph 11, the interim report shall become the final report of the panel of experts.

13. The panel of experts shall deliver its final report to the Parties within 175 days of the date of establishment of the panel of experts. When the panel of experts considers that this time limit cannot be met, its chairperson shall notify the Parties in writing, stating the reasons for the delay and the date on which the panel of experts plans to deliver its final report. The panel of experts shall, under no circumstances, deliver its final report later than 195 days after the date of establishment of the panel of experts.

14. The final report shall include a discussion of any written request by the Parties on the interim report and clearly address the comments of the Parties.

15. The Parties shall make the final report available to the public within 15 days of its delivery by the panel of experts.

16. If the final report of the panel of experts determines that a Party has not conformed with its obligations under the relevant Chapter or Chapters, the Parties shall, within 90 days of the delivery of the final report, discuss appropriate measures to be implemented taking into account the report of the panel of experts. No later than 105 days after the report has been delivered to the Parties, the respondent Party shall inform its domestic advisory groups established under Article INST.7 [Domestic advisory groups] and the complaining Party of its decision on any measures to be implemented.

17. The Trade Specialised Committee on Level Playing Field for Open and Fair Competition and Sustainable Development shall monitor the follow-up to the report of the panel of experts. The domestic advisory groups of the Parties established under Article INST.7 [Domestic advisory groups] may submit observations to the Trade Specialised Committee on Level Playing Field for Open and Fair Competition and Sustainable Development in that regard.

18. When the Parties disagree on the existence of, or the consistency with, the relevant provisions of any measure taken to address the non-conformity, the complaining Party may deliver a request, which shall be in writing, to the original panel of experts to decide on the matter. The request shall identify any measure at issue and explain how that measure is not in conformity with the relevant provisions in a manner sufficient to present the complaint clearly. The panel of experts shall deliver its findings to the Parties within 45 days of the date of the delivery of the request.

19. Except as otherwise provided for in this Article, Article INST.14(1) [Arbitration procedure], Article INST.29 [Arbitration tribunal decisions and rulings], Article INST.30 [Suspension and

termination of the arbitration proceedings], Article INST.31 [Mutually agreed solution], Article INST.32 [Time periods], Article INST.34 [Costs], Article INST.15 [Establishment of an arbitration tribunal], or Article INST.28 [Replacement of arbitrators] as well as ANNEX INST [Rules of Procedure for Dispute Settlement] and ANNEX INST-X [Code of Conduct for Arbitrators], shall apply *mutatis mutandis*.

#### Article 9.3: Panel of experts for non-regression areas

1. Article 9.2 [Panel of experts] shall apply to disputes between the Parties concerning the interpretation and application of Chapter 6 [Labour and Social Standards] and Chapter 7 [Environment and Climate].
2. For the purposes of such disputes, in addition to the Articles listed in Article 9.2(19) [Panel of experts], Article INST.24 [Temporary remedies] and Article INST.25 [Review of any measure taken to comply after the adoption of temporary remedies] shall apply *mutatis mutandis*.
3. The Parties recognise that, where the responding Party chooses not to take any action to conform with the report of the panel of experts report and with this Agreement, any remedies authorised under Article INST.24 [Temporary remedies] continue to be available to the complaining Party.

#### Article 9.4: Rebalancing

1. The Parties recognise the right of each Party to determine its future policies and priorities with respect to labour and social, environmental or climate protection, or with respect to subsidy control, in a manner consistent with each Party's international commitments, including those under this Agreement. At the same time, the Parties acknowledge that significant divergences in these areas can be capable of impacting trade or investment between the Parties in a manner that changes the circumstances that have formed the basis for the conclusion of this Agreement.
2. If material impacts on trade or investment between the Parties are arising as a result of significant divergences between the Parties in the areas referred to in paragraph 1, either Party may take appropriate rebalancing measures to address the situation. Such measures shall be restricted with respect to their scope and duration to what is strictly necessary and proportionate in order to remedy the situation. Priority shall be given to such measures as will least disturb the functioning of this Agreement. A Party's assessment of these impacts shall be based on reliable evidence and not merely on conjecture or remote possibility.
3. The following procedures shall apply to rebalancing measures taken under paragraph 2:
  - (a) The concerned Party shall, without delay, notify the other Party through the Partnership Council of the rebalancing measures it intends to take, providing all relevant information. The Parties shall immediately enter into consultations. Consultations shall be deemed concluded within 14 days from the date of delivery of the notification, unless they are jointly concluded before that time limit.
  - (b) If no mutually acceptable solution is found, the concerned Party may adopt rebalancing measures no sooner than five days from the conclusion of the consultations, unless the notified Party requests within the same five day period, in accordance with Article INST.14(2)

[Arbitration procedure]<sup>64</sup>, the establishment of an arbitration tribunal by means of a written request delivered to the other Party in order for the arbitration tribunal to decide whether the notified rebalancing measures are consistent with paragraph 2 of this Article.

- (c) The arbitration tribunal shall deliver its final ruling within 30 days from its establishment. If the arbitration tribunal does not deliver its final ruling within that time period, the concerned Party may adopt the rebalancing measures no sooner than three days after the expiry of that 30 day time period. In that case, the other Party may take countermeasures proportionate to the adopted rebalancing measures until the arbitration tribunal delivers its ruling. Priority shall be given to such countermeasures as will least disturb the functioning of this Agreement. Point (a) shall apply mutatis mutandis to such countermeasures, which may be adopted no sooner than three days after the conclusion of consultations.
- (d) If the arbitration tribunal has found the rebalancing measures to be consistent with paragraph 2, the concerned Party may adopt the rebalancing measures as notified to the other Party.
- (e) If the arbitration tribunal has found the rebalancing measures to be inconsistent with paragraph 2, the concerned Party shall, within three days from the delivery of the ruling, notify the complaining Party of the measures<sup>65</sup> it intends to adopt to comply with the ruling of the arbitration tribunal. Articles INST.23(2) [Compliance review], INST.24 [Temporary remedies]<sup>66</sup> and INST.25 [Review of any measure taken to comply after the adoption of temporary remedies] shall apply mutatis mutandis, if the complaining Party considers that the notified measures are not in compliance with the ruling of the arbitration tribunal. The procedures under Articles INST.23(2) [Compliance review], INST.24 [Temporary measures] and INST.25 [Review of any measure taken to comply after the adoption of temporary remedies] shall have no suspensive effect on the application of the notified measures pursuant to this paragraph.
- (f) If rebalancing measures were adopted prior to the arbitration ruling in accordance with point (c), any countermeasures adopted pursuant to that point shall be withdrawn immediately, and in no case later than five days, after delivery of the ruling of the arbitration tribunal.
- (g) A Party shall not invoke the WTO Agreement or any other international agreement to preclude the other Party from taking measures pursuant to paragraphs 2 and 3, including when those measures consist of suspension of obligations under this Agreement.
- (h) If the notified Party does not submit a request pursuant to point (b) within the time period laid down therein, that Party may without having prior recourse to consultations in accordance with Article INST.13 [Consultations] initiate the arbitration procedure referred to in Article INST.14 [Arbitration procedure]. An arbitration tribunal shall treat the issue as a case of urgency for the purpose of Article INST.19 [Urgent proceedings].

4. In order to ensure an appropriate balance between the commitments made by the Parties in this Agreement on a more durable basis, either Party may request, no sooner than four years after

---

<sup>64</sup> For greater certainty, in this case the Party shall not have prior recourse to consultations in accordance with Article INST.13 [Consultations].

<sup>65</sup> Such measures may include withdrawal or adjustment of the rebalancing measures, as appropriate

<sup>66</sup> Suspension of obligations under Article INST.24 [Temporary remedies] shall be available only if rebalancing measures have in fact been applied.

the entry into force of this Agreement, a review of the operation of Heading One [Trade] of this Agreement. The Parties may agree that other Headings of this Agreement may be added to the review.

5. Such a review shall commence at a Party's request, if that Party considers that measures under paragraphs 2 or 3 have been taken frequently by either or both Parties, or if a measure that has a material impact on the trade or investment between the Parties has been applied for a period of 12 months. For the purposes of this paragraph, the measures in question are those which were not challenged or not found by an arbitration tribunal to be strictly unnecessary pursuant to point (d) or (h) of paragraph 3. This review may commence earlier than four years after the entry into force of this Agreement.

6. The review requested pursuant to paragraph 4 or 5 shall begin within three months of the request and be completed within six months.

7. A review on the basis of paragraphs 4 or 5 may be repeated at subsequent intervals of no less than four years after the conclusion of the previous review. If a Party has requested a review under paragraphs 4 or 5, it may not request a further review under either paragraph 4 or 5 for at least four years from the conclusion of the previous review or, if applicable, from the entry into force of any amending agreement.

8. The review shall address whether the Agreement delivers an appropriate balance of rights and obligations between the Parties, in particular with regard to the operation of Heading One [Trade], and whether, as a result, there is a need for any modification of the terms of this Agreement.

9. The Partnership Council may decide that no action is required as a result of the review. If a Party considers that following the review there is a need for an amendment of this Agreement, the Parties shall use their best endeavours to negotiate and conclude an agreement making the necessary amendments. Such negotiations shall be limited to matters identified in the review.

10. If an amending agreement referred to in paragraph 9 is not concluded within one year from the date the Parties started negotiations, either Party may give notice to terminate Heading One [Trade] or any other Heading of the Agreement that was added to the review, or the Parties may decide to continue negotiations. If a Party terminates Heading One [Trade], Heading Three [Road transport] shall be terminated on the same date. The termination shall take effect three months after the date of such notice.

11. If Heading One [Trade] is terminated pursuant to paragraph 10, Heading Two [Aviation] shall be terminated at the same date, unless the Parties agree to integrate the relevant parts of Title XI [Level playing field for open and fair competition and sustainable development] in Heading Two [Aviation].

12. Title I [Dispute settlement] of Heading Six [Dispute settlement and horizontal arrangements] does not apply to paragraphs 4 to 9.

## *TITLE XII: EXCEPTIONS*

### Article EXC.1: General exceptions

1. Nothing in Chapter one [National Treatment and market access for goods] and Chapter five of Title I of Heading One of Part two [Customs and trade facilitation], Title VIII of Heading One of Part

two [Energy and raw materials], Chapter four of Title XI of Heading One of Part two [State-owned enterprises], Title III of Heading One of Part two [Digital trade] and Chapter two of Title II of Heading One of Part two [Investment liberalisation] shall be construed as preventing a Party from adopting or maintaining measures compatible with Article XX of GATT 1994. To that end, Article XX of GATT 1994, including its Notes and Supplementary Provisions, is incorporated into and made part of this Agreement, *mutatis mutandis*.

2. Subject to the requirement that such measures are not applied in a manner which would constitute a means of arbitrary or unjustifiable discrimination between countries where like conditions prevail, or a disguised restriction on investment liberalization or trade in services, nothing in Title VIII of Heading One of Part two [Energy and raw materials], Chapter four of Title XI of Heading One of Part two [State-owned enterprises], Title III of Heading One of Part two [Digital trade], Title II of Heading One of Part two [Services and Investment] and Title IV of Heading One of Part two [Capital movements, payments, transfers and temporary safeguard measures] shall be construed to prevent the adoption or enforcement by either Party of measures:

- (a) necessary to protect public security or public morals or to maintain public order<sup>67</sup>;
- (b) necessary to protect human, animal or plant life or health;
- (c) necessary to secure compliance with laws or regulations which are not inconsistent with the provisions of this Agreement, including those relating to:
  - (i) the prevention of deceptive and fraudulent practices or to deal with the effects of a default on contracts;
  - (ii) the protection of the privacy of individuals in relation to the processing and dissemination of personal data and the protection of confidentiality of individual records and accounts; and
  - (iii) safety.

3. For greater certainty, the Parties understand that, to the extent that such measures are otherwise inconsistent with the provisions of the aforementioned Chapters, Sections or Titles:

- (a) the measures referred to in point (b) of Article XX of GATT 1994 and in point (b) of paragraph 2 of this Article include environmental measures, which are necessary to protect human, animal or plant life and health;
- (b) point (g) of Article XX of GATT 1994 applies to measures relating to the conservation of living and non-living exhaustible natural resources; and
- (c) measures taken to implement multilateral environmental agreements can fall under points (b) or (g) of Article XX of GATT 1994 or under point (b) of paragraph 2 of this Article.

---

<sup>67</sup> The public security and public order exceptions may be invoked only where a genuine and sufficiently serious threat is posed to one of the fundamental interests of society.

4. Before a Party takes any measures provided for in points (i) and (j) of Article XX of GATT 1994, that Party shall provide the other Party with all relevant information, with a view to seeking a solution acceptable to the Parties. If no agreement is reached within 30 days of providing the information, the Party may apply the relevant measures. Where exceptional and critical circumstances requiring immediate action make prior information or examination impossible, the Party intending to take the measures may apply forthwith precautionary measures necessary to deal with the situation. That Party shall inform the other Party immediately thereof.

#### Article EXC.2: Taxation

1. Nothing in Titles I to VII, Chapter four [Energy and raw materials] of Title VIII, Titles IX to XII of Heading One of Part Two or Heading Six [Other provisions] of Part Two shall affect the rights and obligations of either the Union or its Member States and the United Kingdom, under any tax convention. In the event of any inconsistency between this Agreement and any such tax convention, the tax convention shall prevail to the extent of the inconsistency. With regard to a tax convention between the Union or its Member States and the United Kingdom, the relevant competent authorities under this Agreement and that tax convention shall jointly determine whether an inconsistency exists between this Agreement and the tax convention<sup>68</sup>.

2. Article SERVIN.2.4 of Chapter two of Title II of Heading One of Part two [Investment Liberalisation] and Article SERVIN.3.4 of Chapter three of Title II of Heading One of Part two [Cross-border trade in services] shall not apply to an advantage accorded pursuant to a tax convention.

3. Subject to the requirement that tax measures are not applied in a manner which would constitute a means of arbitrary or unjustifiable discrimination between countries where like conditions prevail, or a disguised restriction on trade and investment, nothing in Titles I to VII, Chapter four [Energy and raw materials] of Title VIII, Titles IX to XII of Heading One of Part Two or Heading Six [Other provisions] of Part Two shall be construed to prevent the adoption, maintenance or enforcement by a Party of any measure that:

(a) aims at ensuring the equitable or effective<sup>69</sup> imposition or collection of direct taxes; or

---

<sup>68</sup> For greater certainty, such determination shall be without prejudice to Title I of Part Six [Dispute Settlement].

<sup>69</sup> Measures that are aimed at ensuring the equitable or effective imposition or collection of direct taxes include measures taken by a Party under its taxation system which:

- (i) apply to non-resident service suppliers in recognition of the fact that the tax obligation of non-residents is determined with respect to taxable items sourced or located in the Party's territory; or
- (ii) apply to non-residents in order to ensure the imposition or collection of taxes in the Party's territory; or
- (iii) apply to non-residents or residents in order to prevent the avoidance or evasion of taxes, including compliance measures; or
- (iv) apply to consumers of services supplied in or from the territory of the other Party or of a third country in order to ensure the imposition or collection of taxes on such consumers derived from sources in the Party's territory; or

- (b) distinguishes between taxpayers, who are not in the same situation, in particular with regard to their place of residence or with regard to the place where their capital is invested.

4. For the purposes of this Article:

- (a) "residence" means residence for tax purposes;
- (b) "tax convention" means a convention for the avoidance of double taxation or any other international agreement or arrangement relating wholly or mainly to taxation; and
- (c) "direct taxes" comprise all taxes on income or capital, including taxes on gains from the alienation of property, taxes on estates, inheritances and gifts, taxes on wages or salaries paid by enterprises and taxes on capital appreciation.

#### Article EXC.3: WTO Waivers

If an obligation in Titles I to XII of Heading One of Part Two or Heading Six [Other provisions] of Part Two of this Agreement is substantially equivalent to an obligation contained in the WTO Agreement, any measure taken in conformity with a waiver adopted pursuant to Article IX of the WTO Agreement is deemed to be in conformity with the substantially equivalent provision in this Agreement.

#### Article EXC.4: Security exceptions

Nothing in Titles I to XII of Heading One of Part Two or Heading Six [Other provisions] of Part Two of this Agreement shall be construed:

- (a) to require a Party to furnish or allow access to any information the disclosure of which it considers contrary to its essential security interests; or
- (b) to prevent a Party from taking an action which it considers necessary for the protection of its essential security interests:
  - (i) connected to the production of or traffic in arms, ammunition and implements of war and to such production, traffic and transactions in other goods and materials, services and technology, and to economic activities, carried out directly or indirectly for the purpose of supplying a military establishment;
  - (ii) relating to fissionable and fusionable materials or the materials from which they are derived; or
  - (iii) in time of war or other emergency in international relations; or

- 
- (v) distinguish service suppliers subject to tax on worldwide taxable items from other service suppliers, in recognition of the difference in the nature of the tax base between them; or
  - (vi) determine, allocate or apportion income, profit, gain, loss, deduction or credit of resident persons or branches, or between related persons or branches of the same person, in order to safeguard the Party's tax base.



- (c) to prevent a Party from taking any action in pursuance of its obligations under the United Nations Charter for the maintenance of international peace and security.

Article EXC.5: Confidential information

1. Nothing in Titles I to X, Title XI, with the exception of Article LPFS.2.26 [Taxation standards] of Title XI and Title XII of Heading One of Part Two or Heading Six [Other provisions] of Part Two of this Agreement shall be construed as requiring a Party to make available confidential information, the disclosure of which would impede law enforcement, or otherwise be contrary to the public interest, or which would prejudice the legitimate commercial interests of particular enterprises, public or private, except where an arbitration tribunal requires such confidential information in dispute settlement proceedings under Title I [Dispute settlement] of Part Six, or where a panel of experts requires such confidential information in proceedings under Article LPFS.9.2 [Panel of experts] or Article LPFS.9.3 [Panel of experts for non-regression areas]. In such cases, the arbitration tribunal, or, as the case may be, the panel of experts shall ensure that confidentiality is fully protected in accordance with ANNEX INST-X [Rules of Procedure].
2. When a Party submits information to the Partnership Council or to Committees that is considered as confidential under its laws and regulations, the other Party shall treat that information as confidential, unless the submitting Party agrees otherwise.



## HEADING TWO: AVIATION

### TITLE I: AIR TRANSPORT

#### Article AIRTRN.1: Definitions

For the purposes of this Title, the following definitions apply:

- (a) “air carrier” means an air transport undertaking holding a valid operating licence or equivalent;
- (b) “air carrier of the Union” means an air carrier that fulfils the conditions laid down in point (b) of Article AIRTRN.6(1) [Operating authorisations and technical permissions];
- (c) “air carrier of the United Kingdom” means an air carrier that fulfils the conditions laid down in point (a) of Article AIRTRN.6(1) or 6(2) [Operating authorisations and technical permissions];
- (d) “air navigation services” means air traffic services, communication, navigation and surveillance services, meteorological services for air navigation, and aeronautical information services;
- (e) “air operator certificate” means a document issued to an air carrier which affirms that the air carrier in question has the professional ability and organisation to secure the safe operation of aircraft for the aviation activities specified in the certificate;
- (f) “air traffic management” means the aggregation of the airborne and ground-based functions (air traffic services, airspace management and air traffic flow management) required to ensure the safe and efficient movement of aircraft during all phases of operations;
- (g) "air transport" means the carriage by aircraft of passengers, baggage, cargo, and mail, separately or in combination, held out to the public for remuneration or hire;
- (h) "citizenship determination" means a finding that an air carrier proposing to operate air services under this Title satisfies the requirements of Article AIRTRN.6 [Operating authorisations and technical permissions] regarding its ownership, effective control and principal place of business;
- (i) “competent authorities” means, for the United Kingdom, the authorities of the United Kingdom responsible for the regulatory and administrative functions incumbent on the United Kingdom under this Title; and for the Union, the authorities of the Union and of the Member States responsible for the regulatory and administrative functions incumbent on the Union under this Title;
- (j) “the Convention” means the Convention on International Civil Aviation, signed in Chicago on 7 December 1944, and includes:
  - (i) any amendment that has entered into force under Article 94(a) of the Convention and has been ratified by the United Kingdom and the Member State or Member States concerned, as is relevant to the issue in question; and
  - (ii) any Annex or any amendment thereto adopted under Article 90 of the Convention, insofar as such Annex or amendment is at any given time effective for the United

Kingdom and the Member State or Member States concerned, as is relevant to the issue in question;

- (k) “discrimination” means differentiation of any kind without objective justification in respect of the supply of goods or services, including public services, employed for the operation of air transport services, or in respect of their treatment by public authorities relevant to such services;
- (l) “effective control” means a relationship constituted by rights, contracts or any other means which, either separately or jointly, and having regard to the considerations of fact or law involved, confer the possibility of directly or indirectly exercising a decisive influence on an undertaking, in particular by:
  - (i) the right to use all or part of the assets of an undertaking;
  - (ii) rights or contracts which confer a decisive influence on the composition, voting or decisions of the bodies of an undertaking or otherwise confer a decisive influence on the running of the business of the undertaking;
- (m) “fitness determination” means a finding that an air carrier proposing to operate air services under this Title has satisfactory financial capability and adequate managerial expertise to operate such services and is disposed to comply with the laws, regulations and requirements that govern the operation of such services;
- (n) “full cost” means the cost of the service provided, which may include appropriate amounts for cost of capital and depreciation of assets, as well as the costs of maintenance, operation, management and administration;
- (o) “ICAO” means the United Nations International Civil Aviation Organization;
- (p) “principal place of business” means the head office or registered office of an air carrier within which the principal financial functions and operational control, including continued airworthiness management, of that air carrier are exercised;
- (q) “ramp inspection” means an examination by the competent authority of a Party or its designated representatives, on board and around an aircraft of the other Party, to check both the validity of the relevant aircraft documents and those of its crew members and the apparent condition of the aircraft and its equipment;
- (r) “self-handling” means the performance of ground handling operations by an air carrier directly for itself or for another air carrier where:
  - (i) one holds the majority in the other; or
  - (ii) a single body has a majority holding in each;
- (s) “scheduled air services” means air services which are scheduled and performed for remuneration according to a published timetable, or which are so regular or frequent as to constitute a recognisably systematic series, and which are open to direct booking by members of the public; and extra section flights occasioned by overflow traffic from scheduled flights;
- (t) “stop for non-traffic purposes” means a landing for any purpose other than taking on board or discharging passengers, baggage, cargo and/or mail in air transport;

- (u) “tariff” means any fare, rate or charge for the carriage of passengers, baggage or cargo (excluding mail) in air transport (including any other mode of transport in connection therewith) charged by air carriers, including their agents, and the conditions governing the availability of such fare, rate or charge;
- (v) “user charge” means a charge imposed on air carriers for the provision of airport, air navigation (including overflights), aviation security facilities or services including related services and facilities, or environment-related charges including noise-related charges and charges to address local air quality problems at or around airports.

#### Article AIRTRN.2: Route schedule

1. Subject to Article AIRTRN.3 [Traffic rights], the Union shall grant the United Kingdom the right for the air carriers of the United Kingdom to operate, while carrying out air transport, on the following routes:

Points in the territory of the United Kingdom – Intermediate Points – Points in the territory of the Union – Points Beyond.

2. Subject to Article AIRTRN.3 [Traffic rights], the United Kingdom shall grant the Union the right for the air carriers of the Union to operate, while carrying out air transport, on the following routes:

Points in the territory of the Union – Intermediate Points – Points in the territory of the United Kingdom – Points Beyond.

#### Article AIRTRN.3: Traffic rights

1. Each Party shall grant to the other Party the right for its respective air carriers, for the purpose of carrying out air transport on the routes laid down in Article AIRTRN.2 [Route schedule], to:

- (a) fly across its territory without landing;
- (b) make stops in its territory for non-traffic purposes.

2. The United Kingdom shall enjoy the right for its air carriers to make stops in the territory of the Union to provide scheduled and non-scheduled air transport services between any points situated in the territory of the United Kingdom and any points situated in the territory of the Union (third and fourth freedom traffic rights).

3. The Union shall enjoy the right for its air carriers to make stops in the territory of the United Kingdom to provide scheduled and non-scheduled air transport services between any points situated in the territory of the Union and any points situated in the territory of the United Kingdom (third and fourth freedom traffic rights).

4. Notwithstanding paragraphs 1, 2 and 3 and without prejudice to paragraph 9, the Member States and the United Kingdom may, subject to the respective internal rules and procedures of the Parties, enter into bilateral arrangements by which, as a matter of this Agreement, they grant each other the following rights:

- (a) for the United Kingdom, the right for its air carriers to make stops in the territory of the Member State concerned to provide scheduled and non-scheduled all-cargo air transport services, between points situated in the territory of that Member State and points situated in a third country as part of a service with origin or destination in the territory of the United Kingdom (fifth freedom traffic rights);
  - (b) for the Member State concerned, the right for Union air carriers to make stops in the territory of the United Kingdom to provide scheduled and non-scheduled all-cargo air transport services between points situated in the territory of the United Kingdom and points situated in a third country, as part of a service with origin or destination in the territory of that Member State (fifth freedom traffic rights).
5. The rights mutually granted in accordance with paragraph 4 shall be governed by the provisions of this Title.
6. Neither Party shall unilaterally limit the volume of traffic, capacity, frequency, regularity, routing, origin or destination of the air transport services operated in accordance with paragraphs 2, 3 and 4, or the aircraft type or types operated for that purpose by the air carriers of the other Party, except as may be required for customs, technical, operational, air traffic management, safety, environmental or health protection reasons, in a non-discriminatory manner, or unless otherwise provided for in this Title.
7. Nothing in this Title shall be deemed to confer on the United Kingdom the right for its air carriers to take on board in the territory of a Member State passengers, baggage, cargo or mail carried for compensation and destined for another point in the territory of that Member State or any other Member State.
8. Nothing in this Title shall be deemed to confer on the Union the right for its air carriers to take on board in the territory of the United Kingdom passengers, baggage, cargo or mail carried for compensation and destined for another point in the territory of the United Kingdom.
9. Subject to the internal rules and procedures of the Parties, the competent authorities of the United Kingdom and of the Member States may authorise non-scheduled air transport services beyond the rights provided for in this Article provided that they do not constitute a disguised form of scheduled services, and may establish bilateral arrangements regarding the procedures to be followed for the handling of, and decisions on, air carriers' applications.

#### Article AIRTRN.4: Code-share and blocked space arrangements

1. Air transport services in accordance with Article AIRTRN.3 [Traffic rights] may be provided by means of blocked-space or code-share arrangements, as follows:
- (a) an air carrier of the United Kingdom may act as the marketing carrier with any operating carrier that is an air carrier of the Union or an air carrier of the United Kingdom, or with any operating carrier of a third country which, under Union law or, as applicable, under the law of the Member State or Member States concerned, enjoys the necessary traffic rights as well as the right for its air carriers to exercise those rights by means of the arrangement in question;
  - (b) an air carrier of the Union may act as the marketing carrier with any operating carrier that is an air carrier of the Union or an air carrier of the United Kingdom, or with any operating carrier of a third country which, under United Kingdom law enjoys the necessary traffic rights

as well as the right for its air carriers to exercise those rights by means of the arrangement in question;

- (c) an air carrier of the United Kingdom may act as the operating carrier with any marketing carrier that is an air carrier of the Union or an air carrier of the United Kingdom, or with any marketing carrier of a third country which, under Union law or, as applicable, under the law of the Member State or Member States concerned, enjoys the necessary rights to enter into the arrangement in question;
- (d) an air carrier of the Union may act as the operating carrier with any marketing carrier that is an air carrier of the Union or an air carrier of the United Kingdom, or with any marketing carrier of a third country which, under United Kingdom law, enjoys the necessary rights to enter into the arrangement in question;
- (e) in the context of the arrangements provided under points (a) to (d), an air carrier of one Party may act as the marketing carrier in a blocked-space or code-share arrangement, in services between any pair of points of which both origin and destination are situated in the territory of the other Party provided that the following conditions are fulfilled:
  - (i) the conditions laid down in point (a) or (b), as the case may be, as regards the operating carrier; and
  - (ii) the transport service in question forms part of a carriage by the marketing carrier between a point in the territory of its Party and that destination point in the territory of the other Party.

2. An air carrier of one Party may act as the marketing carrier in a blocked-space or code-share arrangement, in services between any pair of points of which one is situated in the territory of the other Party and the other is situated in a third country, provided that the following conditions are fulfilled:

- (a) the conditions laid down in point (a) or (b) of paragraph 1, as the case may be, as regards the operating carrier; and
- (b) the transport service in question forms part of a carriage by the marketing carrier between a point in the territory of its Party and that point in a third country.

3. In respect of each ticket sold involving the arrangements referred to in this Article, the purchaser shall be informed upon reservation of which air carrier will operate each sector of the service. Where that is not possible, or in case of change after reservation, the identity of the operating carrier shall be communicated to the passenger as soon as it is established. In all cases, the identity of the operating carrier or carriers shall be communicated to the passenger at check-in, or before boarding where no check-in is required for a connecting flight.

4. The Parties may require the arrangements referred to in this Article to be approved by their competent authorities for the purpose of verifying compliance with the conditions set out therein and with other requirements provided for in this Agreement, in particular as regards competition, safety and security.

5. In no case shall recourse to code-share or blocked-space arrangements result in the air carriers of the Parties exercising traffic rights on the basis of this Agreement other than those provided for in Article AIRTRN.3 [Traffic rights].

#### Article AIRTRN.5: Operational flexibility

The rights mutually granted by the Parties in accordance with Article AIRTRN.3(2), (3) and (4) [Traffic rights] shall include, within the limits laid down therein, all of the following prerogatives:

- (a) to operate flights in either or both directions;
- (b) to combine different flight numbers within one aircraft operation;
- (c) to serve points in the route schedule in any combination and in any order;
- (d) to transfer traffic between aircraft of the same air carrier at any point (change of gauge);
- (e) to carry stopover traffic through any points whether within or outside the territory of either Party;
- (f) to carry transit traffic through the territory of the other Party;
- (g) to combine traffic on the same aircraft regardless of where such traffic originates;
- (h) to serve more than one point on the same service (co-terminalisation).

#### Article AIRTRN.6: Operating authorisations and technical permissions

1. On receipt of an application for an operating authorisation from an air carrier of a Party, in the form and manner prescribed, to operate air transport services under this Title, the other Party shall grant the appropriate authorisations and technical permissions with minimum procedural delay, provided that all the following conditions are met:

- (a) in the case of an air carrier of the United Kingdom:
  - (i) the air carrier is owned, directly or through majority ownership, and is effectively controlled by the United Kingdom, its nationals, or both;
  - (ii) the air carrier has its principal place of business in the territory of the United Kingdom, and is licenced in accordance with the law of the United Kingdom; and
  - (iii) the air carrier holds an air operator certificate issued by the competent authority of the United Kingdom, which shall be clearly identified, and that authority exercises and maintains effective regulatory control of the air carrier;
- (b) in the case of an air carrier of the Union:
  - (i) the air carrier is owned, directly or through majority ownership, and is effectively controlled by one or more Member States, by other member states of the European Economic Area, by Switzerland, by nationals of such states, or by a combination thereof;
  - (ii) the air carrier has its principal place of business in the territory of the Union and holds a valid operating licence in accordance with Union law; and

- (iii) the air carrier holds an air operator certificate issued by the competent authority of the Union or a Member State, which shall be clearly identified, and that authority exercises and maintains effective regulatory control of the air carrier;
  - (c) Articles AIRTRN.18 [Aviation safety] and AIRTRN.19 [Aviation security] are being complied with; and
  - (d) the air carrier meets the conditions prescribed under the laws and regulations normally applied to the operation of international air transport by the Party considering the application or applications.
2. Notwithstanding point (a)(i) of paragraph 1, the appropriate operating authorisations and permissions shall be granted to air carriers of the United Kingdom provided that all the following conditions are met:
- (a) the conditions laid down in points (a)(ii), (a)(iii), (c) and (d) of paragraph 1 are complied with;
  - (b) the air carrier is owned, directly or through majority ownership, and is effectively controlled by one or more Member States, by other member states of the European Economic Area, by Switzerland, by nationals of such states, or by a combination thereof, whether alone or together with the United Kingdom and/or nationals of the United Kingdom;
  - (c) on the day the transition period ended, the air carrier held a valid operating licence in accordance with Union Law.
3. For the purposes of paragraphs 1 and 2, evidence of effective regulatory control includes but is not limited to:
- (a) the air carrier concerned holding a valid operating licence or permit issued by the competent authority and meeting the criteria of the Party issuing the operating licence or permit for the operation of international air services; and
  - (b) that Party having and maintaining safety and security oversight programmes for that air carrier in compliance with ICAO standards.
4. When granting operating authorisations and technical permissions, each Party shall treat all air carriers of the other Party in a non-discriminatory manner.
5. On receipt of an application for an operating authorisation from an air carrier of a Party, the other Party shall recognise any fitness determination or citizenship determination or both made by the first Party with respect to that air carrier as if such determination had been made by its own competent authorities, and shall not enquire further into such matters, except as provided for in Article AIRTRN.8(3) [Refusal, revocation, suspension or limitation of operating authorisation].

#### Article AIRTRN.7: Operating plans, programmes and schedules

Notification of operating plans, programmes or schedules for air services operated under this Title may be required by a Party for information purposes only. Where a Party requires such notification, it shall minimise the administrative burden associated with its notification requirements and procedures that is borne by air transport intermediaries and the air carriers of the other Party.



#### Article AIRTRN.8: Refusal, revocation, suspension or limitation of operating authorisation

1. The Union may take action against an air carrier of the United Kingdom, in accordance with paragraphs 3, 4 and 5 of this Article, in any of the following cases:

- (a) in the case of authorisations and permissions granted in accordance with point (a) of Article AIRTRN. 6(1) [Operating authorisations and technical permissions], any of the conditions laid down therein is not met;
- (b) in the case of authorisations and permissions granted in accordance with Article AIRTRN. 6(2)[Operating authorisations and technical permissions], any of the conditions laid down therein is not met;
- (c) the air carrier has failed to comply with the laws and regulations referred to in Article AIRTRN.10 [Compliance with laws and regulations]; or
- (d) such action is necessary in order to prevent, protect against or control the spread of disease, or otherwise protect public health.

2. The United Kingdom may take action against an air carrier of the Union in accordance with paragraphs 3, 4 and 5 of this Article in any of the following cases:

- (a) any of the conditions laid down in point (b) of Article AIRTRN.6(1) [Operating authorisations and technical permissions] is not met;
- (b) the air carrier has failed to comply with the laws and regulations referred to in Article AIRTRN.10 [Compliance with laws and regulations] of this Title; or
- (c) such action is necessary in order to prevent, protect against or control the spread of disease, or otherwise protect public health.

3. Where a Party has reasonable grounds to believe that an air carrier of the other Party is in any of the situations referred to in paragraph 1 or 2, as the case may be, and that action must be taken in that respect, that Party shall notify the other Party in writing as soon as possible of the reasons for the intended refusal, suspension or limitation of the operating authorisation or technical permission and request consultations.

4. Such consultations shall start as soon as possible and not later than 30 days from receipt of the request for consultations. Failure to reach a satisfactory agreement within 30 days or an agreed time period from the starting date of such consultations, or failure to take the agreed corrective action, shall constitute grounds for the Party that requested the consultations to take action to refuse, revoke, suspend, impose conditions on or limit the operating authorisation or technical permissions of the air carrier or air carriers concerned to ensure compliance with Articles AIRTRN.6 [Operating authorisations and technical permissions] and AIRTRN.10 [Compliance with laws and regulations]. Where measures have been taken to refuse, revoke, suspend or limit the operating authorisation or technical permission of an air carrier, a Party may have recourse to arbitration in accordance with Article INST.14 [Arbitration procedure], without having prior recourse to consultations in accordance with Article INST.13 [Consultations]. An arbitration tribunal shall treat the issue as a case of urgency for the purpose of Article INST.19 [Urgent Proceedings]. At the request of a Party, the tribunal may, pending its final ruling, order the adoption of interim relief measures, including the modification or suspension of measures taken by either Party under this Article.



5. Notwithstanding paragraphs 3 and 4, in the cases referred to in points (c) and (d) of paragraph 1, and in points (b) and (c) of paragraph 2, a Party may take immediate or urgent action where required by an emergency or to prevent further non-compliance. For the purposes of this paragraph, further non-compliance means that the question of non-compliance has already been raised between the competent authorities of the Parties.

6. This Article is without prejudice to the provisions of Title XI [Level playing field for open and fair competition and sustainable development] of Heading One, Article AIRTRN 11(4) [Non-Discrimination], Article AIRTRN 18 (4), (6) and (8) [Aviation Safety] and Article AIRTRN 19(12) [Aviation Security] and to the dispute settlement procedure laid down in Title I [Dispute Settlement] of Part Six or to the measures resulting therefrom.

#### Article AIRTRN.9: Ownership and control of air carriers

The Parties recognise the potential benefits of the continued liberalisation of ownership and control of their respective air carriers. The Parties agree to examine in the Specialised Committee on Air Transport options for the reciprocal liberalisation of the ownership and control of their air carriers within 12 months from the entry into force of this Agreement, and thereafter within 12 months of receipt of a request to do so from one of the Parties. As a result of this examination, the Parties may decide to amend this Title.

#### Article AIRTRN.10: Compliance with laws and regulations

1. The laws and regulations of a Party relating to the admission to, operation within, and departure from its territory of aircraft engaged in international air transport shall be complied with by the air carriers of the other Party while entering, operating within, or leaving the territory of that Party, respectively.

2. The laws and regulations of a Party relating to the admission to, operation within, or departure from its territory of passengers, crew, baggage, cargo, or mail on aircraft (including regulations relating to entry, clearance, immigration, passports, customs and quarantine, or in the case of mail, postal regulations) shall be complied with by, or on behalf of, such passengers, crew, baggage, cargo, and mail carried by the air carriers of the other Party while entering, operating within, or leaving the territory of that Party, respectively.

3. The Parties shall permit, in their respective territory, the air carriers of the other Party to take appropriate measures to ensure that only persons with the travel documents required for entry into, or transit through, the territory of the other Party are carried.

#### AIRTRN.11: Non-Discrimination

1. Without prejudice to Title XI [Level playing field for open and fair competition and sustainable development] of Heading One, the Parties shall eliminate, within their respective jurisdictions, all forms of discrimination which would adversely affect the fair and equal opportunity of the air carriers of the other Party to compete in the exercise of the rights provided for in this Title.

2. A Party (the “initiating Party”) may proceed in accordance with paragraphs 3 to 6 where it considers that its air carriers’ fair and equal opportunities to compete in the exercise of the rights provided for in this Title are adversely affected by discrimination prohibited by paragraph 1.

3. The initiating Party shall submit a written request for consultations to the other Party (the “responding Party”). Consultations shall start within a period of 30 days from the receipt of the request, unless otherwise agreed by the Parties.

4. Where the initiating Party and the responding Party fail to reach agreement on the matter within 60 days from the receipt of the request for consultations referred to in paragraph 3, the initiating Party may take measures against all or part of the air carriers which have benefitted from discrimination prohibited by paragraph 1, including action to refuse, revoke, suspend, impose conditions on or limit the operating authorisations or technical permissions of the air carriers concerned.

5. The measures taken pursuant to paragraph 4 shall be appropriate, proportionate and restricted in their scope and duration to what is strictly necessary to mitigate the injury to the air carriers of the initiating Party and remove the undue advantage gained by the air carriers against which they are directed.

6. Where consultations have not resolved the matter or where measures have been taken pursuant to paragraph 4, a Party may have recourse to arbitration in accordance with Article INST.14 [Arbitration procedure], without having prior recourse to consultations in accordance with Article INST.13 [Consultations]. An arbitration tribunal shall treat the issue as a case of urgency for the purpose of Article INST.19 [Urgent Proceedings]. At the request of a Party, the tribunal may, pending its final ruling, order the adoption of interim relief measures, including the modification or suspension of measures taken by either Party under this Article.

7. Notwithstanding paragraph 2, the Parties shall not proceed under paragraphs 3 to 6 in relation to conduct falling under the scope of Title XI [Level playing field for open and fair competition and sustainable development] of Heading One.

#### Article AIRTRN.12: Doing business

1. The Parties agree that obstacles to doing business encountered by air carriers would hamper the benefits under this Title. The Parties agree to cooperate in removing obstacles to doing business for air carriers of both Parties where such obstacles may hamper commercial operations, create distortions to competition or affect equal opportunities to compete.

2. The Specialised Committee on Air Transport shall monitor progress in effectively addressing matters relating to obstacles to doing business for air carriers.

#### Article AIRTRN.13: Commercial operations

1. The Parties shall grant each other the rights laid down in paragraphs 2 to 7. For the purposes of the exercise of those rights, the air carriers of each Party shall not be required to retain a local sponsor.

2. As regards air carrier representatives:

(a) the establishment of offices and facilities by the air carriers of one Party in the territory of the other Party as necessary to provide services under this Title shall be allowed without restriction or discrimination;

(b) without prejudice to safety and security regulations, where such offices and facilities are located in an airport they may be subject to limitations on grounds of availability of space;

- (c) each Party shall, in accordance with its laws and regulations relating to entry, residence and employment, authorise the air carriers of the other Party to bring in and maintain in the territory of the authorising Party those of their own managerial, sales, technical, operational and other specialist staff which the air carrier reasonably considers necessary for the provision of air transport services under this Title. Where employment authorisations are required for the personnel referred to in this paragraph, including those performing certain temporary duties, the Parties shall process applications for such authorisations expeditiously, subject to the relevant laws and regulations.
3. As regards ground handling:
- (a) each Party shall permit the air carriers of the other Party to perform self-handling in its territory without restrictions other than those based on considerations of safety or security, or otherwise resulting from physical or operational constraints;
  - (b) each Party shall not impose on the air carriers of the other Party the choice of one or more providers of ground handling services among those which are present in the market in accordance with the laws and regulations of the Party where the services are provided;
  - (c) without prejudice to point (a), where the laws and regulations of a Party limit or restrict in any way free competition between providers of ground handling services, that Party shall ensure that all necessary ground handling services are available to the air carriers of the other Party and that they are provided under no less favourable terms than those under which they are provided to any other air carrier.
4. As regards the allocation of slots at airports, each Party shall ensure that its regulations, guidelines and procedures for allocation of slots at the airports in its territory are applied in a transparent, effective, non-discriminatory and timely manner.
5. As regards local expenses and transfer of funds and earnings:
- (a) the provisions of Title IV [Capital movements, payments, transfers and temporary safeguard measures] of Heading One apply to the matters governed by this Title, without prejudice to Article AIRTRN.6 [Operating authorisations and technical permissions];
  - (b) the Parties shall grant each other the benefits laid down in points (c) to (e);
  - (c) it shall be possible for the sale and purchase of transport and related services by the air carriers of the Parties, at the discretion of the air carrier, to be denominated in pounds sterling if the sale or purchase takes place in the territory of the United Kingdom, or, if the sale or purchase take place in the territory of a Member State, to be denominated in the currency of that Member State;
  - (d) the air carriers of each Party shall be permitted to pay for local expenses in local currency, at their discretion;
  - (e) the air carriers of each Party shall be permitted, on demand, to remit revenues obtained in the territory of the other Party from the sale of air transport services and associated activities directly linked to air transport in excess of sums locally disbursed, at any time, in any way, to the country of their choice. Prompt conversion and remittance shall be permitted without restrictions or taxation in respect thereof at the market rate of exchange applicable to current transactions and remittance on the date the carrier makes the initial application for

remittance and shall not be subject to any charges except those normally made by banks for carrying out such conversion and remittance.

6. As regards intermodal transport:

- (a) in relation to the transport of passengers, the Parties shall not subject surface transport providers to laws and regulations governing air transport on the sole basis that such surface transport is held out by an air carrier under its own name;
- (b) subject to any conditions and qualifications set out in Title II [SERVICES AND INVESTMENT] of Heading One and its Annexes and in Title I [Transport of Goods by Road] of Heading Three and its Annex, air carriers of each Party shall be permitted, without restriction, to employ in connection with international air transport any surface transport for cargo to or from any points in the territories of the Parties, or in third countries, including transport to and from all airports with customs facilities, and including, where applicable, the right to transport cargo in bond under applicable laws and regulations. Such cargo, whether moving by surface or by air, shall have access to airport customs processing and facilities. Air carriers may elect to perform their own surface transport or to provide it through arrangements, including code share, with other surface transport providers, including surface transport operated by other air carriers and indirect providers of cargo air transport. Such inter-modal cargo services may be offered as a through service and at a single price for the air and surface transport combined, provided that shippers are informed as to the providers of the transport involved.

7. As regards leasing:

- (a) the Parties shall grant each other the right for their air carriers to provide air transport services in accordance with Article AIRTRN.3 [Traffic rights] in all the following ways:
  - (i) using aircraft leased without crew from any lessor;
  - (ii) in the case of air carriers of the United Kingdom, using aircraft leased with crew from other air carriers of the Parties;
  - (iii) in the case of air carriers of the Union, using aircraft leased with crew from other air carriers of the Union;
  - (iv) using aircraft leased with crew from air carriers other than those referred to in points (ii) and (iii), respectively, provided that the leasing is justified on the basis of exceptional needs, seasonal capacity needs or operational difficulties of the lessee, and the leasing does not exceed the duration which is strictly necessary to fulfil those needs or overcome those difficulties;
- (b) the Parties may require leasing arrangements to be approved by their competent authorities for the purpose of verifying compliance with the conditions set out in this paragraph and with the applicable safety and security requirements;
- (c) however, where a Party requires such approval, it shall endeavour to expedite the approval procedures and minimise the administrative burden on the air carriers concerned;
- (d) the provisions of this paragraph are without prejudice to the laws and regulations of a Party as regards the leasing of aircraft by air carriers of that Party.

#### Article AIRTRN.14: Fiscal provisions

1. On arriving in the territory of one Party, aircraft operated in international air transport by the air carriers of the other Party, their regular equipment, fuel, lubricants, consumable technical supplies, ground equipment, spare parts (including engines), aircraft stores (including but not limited to such items as food, beverages and liquor, tobacco and other products destined for sale to, or use by, passengers in limited quantities during flight) and other items intended for or used solely in connection with the operation or servicing of aircraft engaged in international air transport shall, on the basis of reciprocity, and provided that such equipment and supplies remain on board the aircraft, be exempt from all import restrictions, property taxes and capital levies, customs duties, excise taxes, inspection fees, value added tax or other similar indirect taxes, and similar fees and charges imposed by the national or local authorities or the Union.

2. The following goods shall also be exempt, on the basis of reciprocity, from the taxes, levies, duties, fees and charges referred to in paragraph 1:

- (a) aircraft stores introduced into or supplied in the territory of a Party and taken on board, within reasonable limits, for use on outbound aircraft of an air carrier of the other Party used in international air transport, even when these stores are to be used on a part of the journey performed over the said territory;
- (b) ground equipment and spare parts (including engines) introduced into the territory of a Party for the servicing, maintenance, or repair of aircraft of an air carrier of the other Party used in international air transport;
- (c) lubricants and consumable technical supplies other than fuel introduced into or supplied in the territory of a Party for use in an aircraft of an air carrier of the other Party used in international air transport, even when those supplies are to be used on a part of the journey performed over the said territory; and
- (d) printed matter, as provided for by the customs legislation of each Party, introduced into or supplied in the territory of one Party and taken on board for use on outbound aircraft of an air carrier of the other Party engaged in international air transport, even when those stores are to be used on a part of the journey performed over the said territory.

3. The regular airborne equipment, as well as the material, supplies and spare parts referred to in paragraph 1 normally retained on board aircraft operated by an air carrier of one Party may be unloaded in the territory of the other Party only with the approval of the customs authorities of that Party and may be required to be kept under the supervision or control of the said authorities up to such time as they are re-exported or otherwise disposed of in accordance with applicable regulations.

4. The relief from customs duties, national excise duties and similar national fees provided for in this Article shall also be available in situations where the air carrier or air carriers of one Party have entered into arrangements with another air carrier or air carriers for the loan or transfer in the territory of the other Party of the items specified in paragraphs 1 and 2, provided that such other air carrier or air carriers similarly enjoy such relief from that other Party.

5. Nothing in this Title shall prevent either Party from imposing taxes, levies, duties, fees or charges on goods sold other than for consumption on board to passengers during a sector of an air

service between two points within its territory at which embarkation or disembarkation is permitted.

6. Baggage and cargo in direct transit across the territory of a Party shall be exempt from taxes, customs duties, fees and other similar charges.

7. Equipment and supplies referred to in paragraph 2 may be required to be kept under the supervision or control of the competent authorities.

8. The provisions of the respective conventions in force between the United Kingdom and Member States for the avoidance of double taxation on income and on capital remain unaffected by this Title.

9. The relief from customs duties, national excise duties and similar national fees shall not extend to charges based on the cost of services provided to an air carrier of a Party in the territory of the other Party.

#### Article AIRTRN.15: User charges

1. User charges that may be imposed by one Party on the air carriers of the other Party for the use of air navigation and air traffic control shall be cost-related and non-discriminatory. In any event, any such user charges shall be assessed on the air carriers of the other Party on terms not less favourable than the most favourable terms available to any other air carrier in like circumstances at the time the charges are applied.

2. Without prejudice to Article AIRTRN.13(5) [Commercial Operations], each Party shall ensure that user charges other than those mentioned in paragraph 1 that may be imposed on the air carriers of the other Party are just, reasonable, not unjustly discriminatory, and equitably apportioned among categories of users. User charges imposed on the air carriers of the other Party may reflect, but not exceed, the full cost of providing appropriate airport, airport environmental and aviation security facilities and services at the airport or within the airport system. Such charges may include a reasonable return on assets after depreciation. Facilities and services for which user charges are imposed shall be provided on an efficient and economic basis. In any event, any such user charges shall be assessed on the air carrier of the other Party on terms no less favourable than the most favourable terms available to any other air carrier in like circumstances at the time the charges are applied.

3. In order to ensure the correct application of the principles set out in paragraphs 1 and 2, each Party shall ensure that consultations take place between the competent charging authorities or bodies in its territory and the air carriers using the services and facilities concerned and that the competent charging authorities or bodies and the air carriers exchange such information as may be necessary. Each Party shall ensure that the competent charging authorities provide users with reasonable notice of any proposal for changes in user charges to enable users to express their views before any changes are made.

#### Article AIRTRN.16: Tariffs

1. The Parties shall allow tariffs to be freely established by the air carriers of the Parties on the basis of fair competition in accordance with this Title.

2. The Parties shall not subject the tariffs of each other's air carriers to approval.

#### Article AIRTRN.17: Statistics

1. The Parties shall cooperate within the framework of the Specialised Committee on Air Transport to facilitate the exchange of statistical information related to air transport under this Title.
2. Upon request, each Party shall provide the other Party with non-confidential and non-commercially sensitive available statistics related to air transport under this Title, as required by the respective laws and regulations of the Parties, on a non-discriminatory basis, and as may reasonably be required.

#### Article AIRTRN.18: Aviation safety

1. The Parties reaffirm the importance of close cooperation in the field of aviation safety.
2. Certificates of airworthiness, certificates of competency and licences issued or rendered valid by one Party and still in force shall be recognised as valid by the other Party and its competent authorities, for the purpose of operating air services under this Title, provided that such certificates or licences were issued or rendered valid pursuant to, and in conformity with, as a minimum, the relevant international standards established under the Convention.
3. Each Party may request consultations at any time concerning the safety standards maintained and administered by the other Party in areas relating to aeronautical facilities, flight crew, aircraft and the operation of aircraft. Such consultations shall take place within 30 days of the request.
4. If, following such consultations, one Party finds that the other Party does not effectively maintain and administer safety standards in the areas referred to in paragraph 2 that are at least equal to the minimum standards established at that time pursuant to the Convention, the first Party shall notify the other Party of those findings and the steps considered necessary to conform with those minimum standards, and the other Party shall take appropriate corrective action. Failure by the other Party to take appropriate action within 15 days or such other period as may be agreed shall be grounds for the requesting Party to refuse, revoke, suspend, impose conditions on or limit the operating authorisations or technical permissions, or to otherwise refuse, revoke, suspend, impose conditions on or limit the operations of the air carriers under the safety oversight of the other Party.
5. Any aircraft operated by, or under a lease arrangement on behalf of, an air carrier or air carriers of one Party may, while within the territory of the other Party, be made the subject of a ramp inspection, provided that this does not lead to unreasonable delay in the operation of the aircraft.
6. The ramp inspection or series of ramp inspections can give rise to:
  - (a) serious concerns that an aircraft or the operation of an aircraft does not comply with the minimum standards established at that time pursuant to the Convention; or
  - (b) serious concerns that there is a lack of effective maintenance and administration of safety standards established at that time pursuant to the Convention.

In the event that the Party that conducted the ramp inspection or inspections establishes serious concerns as referred to in point (a) or (b), it shall notify the competent authorities of the other Party that are responsible for the safety oversight of the air carrier operating the aircraft of such findings



and inform them of the steps considered necessary to conform with those minimum standards. Failure to take appropriate corrective action within 15 days or such other period as may be agreed shall constitute grounds for the first Party to refuse, revoke, suspend, impose conditions on or limit the operating authorisations or technical permissions or to otherwise refuse, revoke, suspend, impose conditions on or limit the operations of the air carrier operating the aircraft.

7. In the event that access for the purpose of undertaking a ramp inspection of an aircraft operated by the air carrier or air carriers of one Party in accordance with paragraph 5 is denied, the other Party shall be free to infer that serious concerns as referred to in paragraph 6 arise and proceed in accordance with paragraph 6.

8. Each Party reserves the right to immediately revoke, suspend or limit the operating authorisations or technical permissions or to otherwise suspend or limit the operations of an air carrier or air carriers of the other Party, if the first Party concludes as a result of a ramp inspection, a series of ramp inspections, a denial of access for ramp inspection, consultation or otherwise, that immediate action is essential to the safety of an air carrier operation. The Party taking such measures shall promptly inform the other Party, providing reasons for its action.

9. Any action by one Party in accordance with paragraphs 4, 6 or 8 shall be discontinued once the basis for the taking of that action ceases to exist.

10. Where measures have been taken by a Party pursuant to paragraphs 4, 6 or 8, in the event of a dispute a Party may have recourse to arbitration in accordance with Article INST.14 [Arbitration procedure], without having prior recourse to consultations in accordance with Article INST.13 [Consultations]. An arbitration tribunal shall treat the issue as a case of urgency for the purpose of Article INST.19 [Urgent Proceedings]. At the request of the complaining Party, the tribunal may, pending its final ruling, order the adoption of interim relief measures, including the modification or suspension of measures taken by either Party under this Article.

#### Article AIRTRN.19: Aviation security

1. The Parties shall provide upon request all necessary assistance to each other to address any threat to the security of civil aviation, including the prevention of acts of unlawful seizure of civil aircraft and other unlawful acts against the safety of such aircraft, of their passengers and crew, airports and air navigation facilities, and any other threat to the security of civil aviation.

2. The Parties shall, in their mutual relations, act in conformity with the aviation security standards established by ICAO. They shall require that operators of the aircraft in their registries and the operators of airports in their territory, act, at least, in conformity with such aviation security standards. Each Party shall, on request, provide the other Party notification of any difference between its laws, regulations and practices and the aviation security standards referred to in this paragraph. Each Party may at any time request consultations, to be held without delay, with the other Party to discuss those differences.

3. Each Party shall ensure that effective measures are taken within its territory to protect civil aviation against acts of unlawful interference, including, but not limited to, screening of passengers and their cabin baggage, screening of hold baggage, screening and security controls for persons other than passengers, including crew, and their items carried, screening and security controls for cargo, mail, in-flight and airport supplies, and access control to airside and security restricted areas. Each Party agrees that the security provisions of the other Party relating to the admission to, operating within, or departure from its territory of aircraft shall be observed.



4. The Parties shall endeavour to cooperate on aviation security matters to the highest extent, to exchange information on threat, vulnerability and risk, subject to the mutual agreement of appropriate arrangements for the secure transfer, use, storage and disposal of classified information, to discuss and share best practices, performance and detection standards of security equipment, compliance monitoring best practices and results, and in any other area that the Parties may identify. In particular, the Parties shall endeavour to develop and maintain cooperation arrangements between technical experts on the development and recognition of aviation security standards with the aim of facilitating such cooperation, reducing administrative duplication and fostering early notice and prior discussion of new security initiatives and requirements.

5. Each Party shall make available to the other Party on request the results of audits carried out by ICAO and the corrective actions taken by the audited state, subject to the mutual agreement of appropriate arrangements for the secure transfer, use, storage and disposal of such information.

6. The Parties agree to cooperate on security inspections undertaken by them in the territory of either Party through the establishment of mechanisms, including administrative arrangements, for the reciprocal exchange of information on results of such security inspections. The Parties agree to consider positively requests to participate, as observers, in security inspections undertaken by the other Party.

7. Subject to paragraph 9, and with full regard and mutual respect for the other Party's sovereignty, a Party may adopt security measures for entry into its territory. Where possible, that Party shall take into account the security measures already applied by the other Party and any views that the other Party may offer. Each Party recognises that nothing in this Article limits the right of a Party to refuse entry into its territory of any flight or flights that it deems to present a threat to its security.

8. A Party may take emergency measures to meet a specific security threat. Such measures shall be notified immediately to the other Party. Without prejudice to the need to take immediate action in order to protect aviation security, when considering security measures, a Party shall evaluate possible adverse effects on international air transport and, unless constrained by law, shall take such effects into account when it determines what measures are necessary and appropriate to address the security concerns.

9. With regard to air services bound for its territory, a Party may not require security measures to be implemented in the territory of the other Party. Where a Party considers that a specific threat urgently requires the implementation of temporary measures in addition to the measures already in place in the territory of the other Party, it shall inform the other Party of the particulars of that threat to the extent consistent with the need to protect security information, and of the proposed measures. The other Party shall give positive consideration to such a proposal and may decide to implement additional measures as it deems necessary. Such measures shall be proportionate and limited in time.

10. When an incident or threat of an incident of unlawful seizure of civil aircraft or other unlawful acts against the safety of aircraft, passengers, crew, airports or air navigation facilities occurs, the Parties shall assist each other by facilitating communications and other appropriate measures intended to rapidly and safely terminate such incident or threat.

11. Each Party shall take all measures it finds practicable to ensure that an aircraft subjected to an act of unlawful seizure or other acts of unlawful interference which is on the ground in its territory is detained on the ground unless its departure is necessitated by the overriding duty to

protect human life. Where practicable, such measures shall be taken on the basis of consultations between the Parties.

12. When a Party has reasonable grounds to believe that the other Party does not comply with this Article, that Party may request immediate consultations with the other Party. Such consultations shall start within 30 days of the receipt of such a request. Failure to reach a satisfactory agreement within 15 days or such other period as may be agreed from the date of such request shall constitute grounds for the Party that requested the consultations to take action to refuse, revoke, suspend, impose conditions on or limit the operating authorisation and technical permissions of an air carrier or air carriers of the other Party to ensure compliance with this Article. When required by an emergency, or to prevent further non-compliance with this Article, a Party may take interim action prior to the expiry of the 15 day-period referred to in this paragraph.

13. Any action taken in accordance with paragraph 8 shall be discontinued when the Party in question considers that the action is no longer required or has been superseded by other measures to mitigate the threat. Any action taken in accordance with paragraph 12 shall be discontinued upon compliance by the other Party with this Article. In the case of action taken in accordance with paragraph 8 or 12, this may be discontinued as mutually agreed by the Parties.

14. Where measures or actions have been taken in accordance with paragraphs 7, 8, 9 or 12, a Party may have recourse to the dispute settlement provisions of Title I [Dispute settlement] of Part Six. An arbitration tribunal shall treat the issue as a case of urgency for the purpose of Article INST.19 [Urgent Proceedings].

#### Article AIRTRN.20: Air traffic management

1. The Parties and their respective competent authorities and air navigation service providers shall cooperate with each other in such a way as to enhance the safe and efficient functioning of air traffic in the European region. The Parties shall seek interoperability between each other's service providers.

2. The Parties agree to cooperate on matters concerning the performance and charging of air navigation services and network functions, with a view to optimising overall flight efficiency, reducing costs, minimising environmental impact and enhancing the safety and capacity of air traffic flows between the existing air traffic management systems of the Parties.

3. The Parties agree to promote cooperation between their air navigation service providers in order to exchange flight data and coordinate traffic flows to optimise flight efficiency, with a view to achieving improved predictability, punctuality and service continuity for air traffic.

4. The Parties agree to cooperate on their air traffic management modernisation programmes, including research, development and deployment activities, and to encourage cross-participation in validation and demonstration activities with the goal of ensuring global interoperability.

#### Article AIRTRN.21: Air carrier liability

The Parties reaffirm their obligations under the Convention for the Unification of Certain Rules for International Carriage by Air, done at Montreal on 28 May 1999 (the Montreal Convention).

#### Article AIRTRN.22: Consumer protection

1. The Parties share the objective of achieving a high level of consumer protection and shall cooperate to that effect.
2. The Parties shall ensure that effective and non-discriminatory measures are taken to protect the interests of consumers in air transport. Such measures shall include the appropriate access to information, assistance including for persons with disabilities and reduced mobility, reimbursement and, if applicable, compensation in case of denied boarding, cancellation or delays, and efficient complaint handling procedures.
3. The Parties shall consult each other on any matter related to consumer protection, including their planned measures in that regard.

#### Article AIRTRN.23: Relationship to other agreements

1. Earlier agreements and arrangements relating to the subject matter of this Title between the United Kingdom and the Member States, to the extent that they may not have been superseded by the law of the Union, shall be superseded by this Agreement.
2. The United Kingdom and a Member State may not grant each other any rights in connection with air transport to, from or within their respective territories other than those expressly laid down in this Title, save as provided for in Article AIRTRN.3 (4) and (9) [traffic rights].
3. If the Parties become party to a multilateral agreement, or endorse a decision adopted by ICAO or another international organisation that addresses matters covered by this Title, they shall consult in the Specialised Committee on Air Transport to determine whether this Title should be revised to take into account such developments.
4. Nothing in this Title shall affect the validity and application of existing and future agreements between the Member States and the United Kingdom as regards territories under their respective sovereignty which are not covered by Article FINPROV.1 [Territorial scope].
5. Nothing in this Title shall affect any rights available to the United Kingdom and Member States under the Multilateral Agreement on Commercial Rights of Non-Scheduled Air Services in Europe, signed at Paris on 30 April 1956, to the extent that such rights go beyond those laid down in this Title.

#### Article AIRTRN.24: Suspension and Termination

1. A suspension of this Title, in whole or in part, pursuant to Article INST.24 [Temporary remedies], may be implemented no earlier than the first day of the International Air Transport Association (IATA) traffic season following the season during which the suspension has been notified.
2. Upon termination of this Agreement pursuant to Article FINPROV.8 [Termination] or upon termination of this Title pursuant to Article AIRTRN.25 [Termination of this Title] or Article OTH.10 [Termination of Part Two] or Article FISH.17 [Termination], the provisions governing the matters falling within the scope of this Title shall continue to apply beyond the date of cessation referred to in Article FINPROV.8 [Termination] or Article AIRTRN.25 [Termination of this Title] or Article OTH.10 [Termination of Part Two] or Article FISH.17 [Termination], until the end of the IATA traffic season in progress on that date.

3. The Party suspending this Title, in whole or in part, or terminating this Agreement or this Title shall inform ICAO thereof.

Article AIRTRN.25: Termination of this Title

Without prejudice to Article FINPROV.8 [Termination], Article OTH.10 [Termination of Part Two], and Article FISH.17 [Termination] each Party may at any moment terminate this Title, by written notification through diplomatic channels. In that event, this Title shall cease to be in force on the first day of the ninth month following the date of notification.

Article AIRTRN.26: Registration of the Agreement

This Agreement and any amendments thereto shall, insofar as relevant, be registered with ICAO in accordance with Article 83 of the Convention.

## TITLE II: AVIATION SAFETY

### Article AVSAF.1: Objectives

The objectives of this Title are to:

- (a) enable the reciprocal acceptance, as provided for in the Annexes to this Title, of findings of compliance made and certificates issued by either Party's competent authorities or approved organisations;
- (b) promote cooperation toward a high level of civil aviation safety and environmental compatibility;
- (c) facilitate the multinational dimension of the civil aviation industry;
- (d) facilitate and promote the free flow of civil aeronautical products and services.

### Article AVSAF.2: Definitions

For the purposes of this Title, the following definitions apply:

- (a) "approved organisation" means any legal person certified by the competent authority of either Party to exercise privileges related to the scope of this Title;
- (b) "certificate" means any approval, licence or other document issued as a form of recognition of compliance that a civil aeronautical product, an organisation or a legal or natural person complies with the applicable requirements set out in laws and regulations of a Party;
- (c) "civil aeronautical product" means any civil aircraft, aircraft engine, or aircraft propeller, or subassembly, appliance, part or component, installed or to be installed thereon;
- (d) "competent authority" means a Union or government agency or a government entity responsible for civil aviation safety that is designated by a Party for the purposes of this Title to perform the following functions:
  - (i) to assess the compliance of civil aeronautical products, organisations, facilities, operations and services subject to its oversight with applicable requirements set out in laws, regulations and administrative provisions of that Party;
  - (ii) to conduct monitoring of their continued compliance with these requirements; and
  - (iii) to take enforcement actions to ensure their compliance with these requirements;
- (e) "findings of compliance" means a determination of compliance with the applicable requirements set out in laws and regulations of a Party as the result of actions such as testing, inspections, qualifications, approvals and monitoring;
- (f) "monitoring" means the regular surveillance by a competent authority of a Party to determine continuing compliance with the applicable requirements set out in laws and regulations of that Party;

- (g) “technical agent” means, for the Union, the European Union Aviation Safety Agency (“EASA”), or its successor, and for the United Kingdom, the United Kingdom Civil Aviation Authority (“CAA”), or its successor; and
- (h) “the Convention” means the Convention on International Civil Aviation, signed in Chicago on 7 December 1944, and includes:
  - (i) any amendment that has entered into force under Article 94(a) of the Convention and has been ratified by the United Kingdom and the Member State or Member States concerned, as is relevant to the issue in question; and
  - (ii) any Annex or any amendment thereto adopted under Article 90 of the Convention, insofar as such Annex or amendment is at any given time effective for the United Kingdom and the Member State or Member States concerned, as is relevant to the issue in question.

#### Article AVSAF.3: Scope and implementation

1. The Parties may cooperate in the following areas:
  - (a) airworthiness certificates and monitoring of civil aeronautical products;
  - (b) environmental certificates and testing of civil aeronautical products;
  - (c) design and production certificates and monitoring of design and production organisations;
  - (d) maintenance organisation certificates and monitoring of maintenance organisations;
  - (e) personnel licensing and training;
  - (f) flight simulator qualification evaluation;
  - (g) operation of aircraft;
  - (h) air traffic management and air navigation services; and
  - (i) other areas related to aviation safety subject to Annexes to the Convention.
2. The scope of this Title shall be established by way of Annexes covering each area of cooperation set out in paragraph 1.
3. The Specialised Committee on Aviation Safety may only adopt Annexes as referred to in paragraph 2 where each Party has established that the civil aviation standards, rules, practices, procedures and systems of the other Party ensure a sufficiently equivalent level of safety to permit acceptance of findings of compliance made and certificates issued by its competent authorities or by organisations approved by that competent authority.
4. Each Annex referred to in paragraph 2 shall describe the terms, conditions and methods for the reciprocal acceptance of findings of compliance and certificates, and, if necessary, transitional arrangements.
5. The technical agents may develop implementation procedures for each individual Annex. Technical differences between the Parties' civil aviation standards, rules, practices, procedures and

systems shall be addressed in the Annexes referred to in paragraph 2 and implementation procedures.

#### Article AVSAF.4: General obligations

1. Each Party shall accept findings of compliance made and certificates issued by the other Party's competent authorities or approved organisations, in accordance with the terms and conditions set out in the Annexes referred to in Article AVSAF.3(2) [Scope and implementation].
2. Nothing in this Title shall entail reciprocal acceptance of the standards or technical regulations of the Parties.
3. Each Party shall ensure that its respective competent authorities remain capable and fulfil their responsibilities under this Title.

#### Article AVSAF.5: Preservation of regulatory authority

Nothing in this Title shall be construed as limiting the authority of a Party to determine, through its legislative, regulatory and administrative measures, the level of protection it considers appropriate for safety and the environment.

#### Article AVSAF.6: Safeguard measures

1. Either Party may take all appropriate and immediate measures whenever it considers that there is a reasonable risk that a civil aeronautical product, a service or any activity that falls within the scope of this Title may compromise safety or the environment, may not meet its applicable legislative, regulatory or administrative measures, or may otherwise fail to satisfy a requirement within the scope of the applicable Annex to this Title.
2. Where either Party takes measures pursuant to paragraph 1, it shall inform the other Party in writing within 15 working days of taking such measures, providing reasons therefor.

#### Article AVSAF.7: Communication

1. The Parties shall designate and notify each other of a contact point for the communication related to the implementation of this Title. All such communications shall be in the English language.
2. The Parties shall notify to each other a list of the competent authorities, and thereafter an updated list each time that becomes necessary.

#### Article AVSAF.8: Transparency, regulatory cooperation and mutual assistance

1. Each Party shall ensure that the other Party is kept informed of its laws and regulations related to this Title and any significant changes to such laws and regulations.
2. The Parties shall to the extent possible inform each other of their proposed significant revisions of their relevant laws, regulations, standards, and requirements, and of their systems for issuing certificates insofar as these revisions may have an impact on this Title. To the extent possible, they shall offer each other an opportunity to comment on such revisions and give due consideration to such comments.

3. For the purpose of investigating and resolving specific safety issues, each Party's competent authorities may allow the other Party's competent authorities to participate as observers in each other's oversight activities as specified in the applicable Annex to this Title.

4. For the purpose of monitoring and inspections, each Party's competent authorities shall assist, if necessary, the other Party's competent authorities with the objective of providing unimpeded access to regulated entities subject to its oversight.

5. To ensure the continued confidence by each Party in the reliability of the other Party's processes for findings of compliance, each technical agent may participate as an observer in the other's oversight activities, in accordance with procedures set out in the Annexes to this Title. That participation shall not amount to a systematic participation in oversight activity of the other Party.

#### Article AVSAF.9: Exchange of safety information

The Parties shall, without prejudice to Article AVSAF.11 [Confidentiality and protection of data and information] and subject to their applicable legislation:

- (a) provide each other, on request and in a timely manner, with information available to their technical agents related to accidents, serious incidents or occurrences in relation to civil aeronautical products, services or activities covered by the Annexes to this Title; and
- (b) exchange other safety information as the technical agents may agree.

#### Article AVSAF.10: Cooperation in enforcement activities

The Parties shall, through their technical agents or competent authorities, provide when requested, subject to applicable laws and regulations, as well as to the availability of required resources, mutual cooperation and assistance in investigations or enforcement activities regarding any alleged or suspected violation of laws or regulations falling within the scope of this Title. In addition, each Party shall promptly notify the other Party of any investigation when mutual interests are involved.

#### Article AVSAF.11: Confidentiality and protection of data and information

1. Each Party shall, in accordance with its laws and regulations, maintain the confidentiality of data and information received from the other Party under this Title. Such data and information may only be used by the Party receiving the data and information for the purposes of this Title.

2. In particular, subject to their respective laws and regulations, the Parties shall neither disclose to a third party, including the public, nor permit their competent authorities to disclose to a third party, including the public, any data and information received from the other Party under this Title that constitutes trade secrets, intellectual property, confidential commercial or financial information, proprietary data, or information that relates to an ongoing investigation. To that end, such data and information shall be considered to be confidential.

3. A Party or a competent authority of a Party may, upon providing data or information to the other Party or a competent authority of the other Party, designate data or information that it considers to be confidential and not to be subject to disclosure. In that case, the Party or its competent authority shall clearly mark such data or information as confidential.



4. If a Party disagrees with the designation made by the other Party or a competent authority of that Party in accordance with paragraph 3, the former Party may request consultations with the other Party to address the issue.

5. Each Party shall take all reasonable precautions necessary to protect data and information, received under this Title, from unauthorised disclosure.

6. The Party receiving data and information from the other Party under this Title shall not acquire any proprietary rights on such data and information by reason of its receipt from the other Party.

#### Article AVSAF.12: Adoption and amendments of Annexes to this Title

The Specialised Committee on Aviation Safety may amend ANNEX AVSAF-1 [Airworthiness and Environment Certification] to this Title, adopt or amend Annexes as provided for in Article AVSAF.3(2) [Scope and implementation] and delete any Annex.

#### Article AVSAF.13: Cost recovery

Each Party shall endeavour to ensure that any fees or charges imposed by a Party or its technical agent on a legal or natural person whose activities are covered by this Title shall be just, reasonable and commensurate with the services provided, and shall not create a barrier to trade.

#### Article AVSAF.14: Other agreements and prior arrangements

1. Upon entry into force of this Agreement, this Title shall supersede any bilateral aviation safety agreements or arrangements between the United Kingdom and the Member States with respect to any matter covered by this Title that has been implemented in accordance with Article AVSAF.3 [Scope and implementation].

2. The technical agents shall take necessary measures to revise or terminate, as appropriate, prior arrangements between them.

3. Subject to paragraphs 1 and 2, nothing in this Title shall affect the rights and obligations of the Parties under any other international agreements.

#### Article AVSAF.15: Suspension of reciprocal acceptance obligations

1. A Party shall have the right to suspend, in whole or in part, its acceptance obligations under paragraph 1 of Article AVSAF.4 [General obligations], when the other Party materially violates its obligations under this Title.

2. Before exercising its right to suspend its acceptance obligations, a Party shall request consultations for the purpose of seeking corrective measures of the other Party. During the consultations, the Parties shall, where appropriate, consider the effects of the suspension.

3. Rights under this Article shall be exercised only if the other Party fails to take corrective measures within an appropriate period of time following the consultations. If a Party exercises a right under this Article, it shall notify the other Party of its intention to suspend the acceptance obligations in writing and detail the reasons for suspension.

4. Such suspension shall take effect 30 days after the date of the notification, unless, prior to the end of that period, the Party which initiated the suspension notifies the other Party in writing that it is withdrawing its notification.

5. Such suspension shall not affect the validity of findings of compliance made and certificates issued by the competent authorities or approved organisations of the other Party prior to the date the suspension took effect. Any such suspension that has become effective may be rescinded immediately upon an exchange of diplomatic notes to that effect by the Parties.

#### Article AVSAF.16: Termination of this Title

Without prejudice to Article FINPROV.8 [Termination], Article OTH.10 [Termination of Part Two] and Article FISH.17 [Termination], each Party may at any moment terminate this Title, by written notification through diplomatic channels. In that event, this Title shall cease to be in force on the first day of the ninth month following the date of notification.

HEADING THREE: ROAD TRANSPORT  
*TITLE I: TRANSPORT OF GOODS BY ROAD*

Article ROAD.1: Objective

1. The objective of this Title is to ensure, as regards the transport of goods by road, continued connectivity between, through and within the territories of the Parties and to lay down the rules which are applicable to such transport.
2. The Parties agree not to take discriminatory measures when applying this Title.
3. Nothing in this Title shall affect the transport of goods by road within the territory of one of the Parties by a road haulage operator established in that territory.

Article ROAD.2: Scope

1. This Title applies to the transport of goods by road with a commercial purpose between, through and within the territories of the Parties and is without prejudice to the application of the rules established by the European Conference of Ministers of Transport.
2. Any transport of goods by road for which no direct or indirect remuneration is received and which does not directly or indirectly generate any income for the driver of the vehicle or for others, and which is not linked to professional activity shall be considered as the transport of goods for a non-commercial purpose.

Article ROAD.3: Definitions

For the purposes of this Title and in addition to the definitions set out in Article [SERVIN 1.2] [Definitions] of Chapter one of Title II of Heading one of Part Two [Services and Investment], the following definitions apply:

- (a) “vehicle” means a motor vehicle registered in the territory of a Party, or a coupled combination of vehicles of which the motor vehicle is registered in the territory of a Party, and which is used exclusively for the transport of goods;
- (b) “road haulage operator” means any natural or legal person engaged in the transport of goods with a commercial purpose, by means of a vehicle;
- (c) “road haulage operator of a Party” means a road haulage operator which is a legal person established in the territory of a Party or a natural person of a Party;
- (d) “party of establishment” means the Party in which a road haulage operator is established;
- (e) “driver” means any person who drives a vehicle even for a short period, or who is carried in a vehicle as part of his duties to be available for driving if necessary;
- (f) “transit” means the movement of vehicles across the territory of a Party without loading or unloading of goods;
- (g) “regulatory measures” means:
  - (i) for the Union:

- (A) regulations and directives, as provided for in Article 288 of the Treaty on the Functioning of the European Union (TFEU); and
- (B) implementing and delegated acts, as provided for in Article 290 and 291 TFEU, respectively; and

(ii) for the United Kingdom:

- (A) primary legislation; and
- (B) secondary legislation.

#### Article ROAD.4 Transport of goods between, through and within the territories of the Parties

1. Provided that the conditions in paragraph 2 are fulfilled, road haulage operators of a Party may undertake:

- (a) laden journeys with a vehicle, from the territory of the Party of establishment to the territory of the other Party, and vice versa, with or without transit through the territory of a third country;
- (b) laden journeys with a vehicle from the territory of the Party of establishment to the territory of the same Party with transit through the territory of the other Party;
- (c) laden journeys with a vehicle to or from the territory of the Party of establishment with transit through the territory of the other Party;
- (d) unladen journeys with a vehicle in conjunction with the journeys referred to in points (a) to (c).

2. Road haulage operators of a Party may only undertake a journey referred to in paragraph 1 if:

- (a) they hold a valid licence issued in accordance with Article ROAD.5 [Requirements for operators], except in the cases referred to in Article ROAD.6 [Exemptions from licensing requirements]; and
- (b) the journey is carried out by drivers who hold a Certificate of Professional Competence in accordance with Article ROAD.7(1) [Requirements for drivers].

3. Subject to paragraph 6, and provided that the conditions in paragraph 2 are fulfilled, road haulage operators of the United Kingdom may undertake up to two laden journeys from one Member State to another Member State, without returning to the territory of the United Kingdom, provided that such journeys follow a journey from the territory of the United Kingdom permitted under point (a) of paragraph 1.

4. Without prejudice to paragraph 5, subject to paragraph 6 and provided that the conditions in paragraph 2 are fulfilled, road haulage operators of the United Kingdom may undertake one laden journey within the territory of a Member State provided that operation:

- (a) follows a journey from the territory of the United Kingdom permitted under point (a) of paragraph 1; and

- (b) is performed within seven days of the unloading in the territory of that Member State of goods carried on the journey referred to in point (a).
5. Subject to paragraph 6 and provided that the conditions in paragraph 2 are fulfilled, road haulage operators of the United Kingdom established in Northern Ireland may undertake up to two laden journeys within the territory of Ireland provided that such operations:
- (a) follow a journey from the territory of the Northern Ireland permitted under point (a) of paragraph 1; and
  - (b) are performed within seven days of the unloading in the territory of Ireland of goods carried on the journey referred to in point (a).
6. Road haulage operators of the United Kingdom shall be limited to a maximum of two journeys within the territory of the Union under paragraphs 3, 4 and 5 before returning to the territory of the United Kingdom.
7. Provided that the conditions in paragraph 2 are fulfilled, road haulage operators of the Union may undertake up to two laden journeys within the territory of the United Kingdom provided that such operations:
- (a) follow a journey from the territory of the Union permitted under point (a) of paragraph 1; and
  - (b) are performed within seven days of the unloading in the territory of the United Kingdom of the goods carried on the journey referred to in point (a).

#### Article ROAD.5: Requirements for operators

1. Road haulage operators of a Party undertaking a journey referred to in Article ROAD.4 [Transport of goods between, through and within the territories of the Parties] shall hold a valid licence issued in accordance with paragraph 2 of this Article.
2. Licences shall only be issued, in accordance with the law of the Parties, to road haulage operators who comply with the requirements set out in Section 1 of Part A of Annex ROAD-1 governing the admission to, and the pursuit of, the occupation of road haulage operator.
3. A certified true copy of the licence shall be kept on board the vehicle and shall be presented at the request of any inspecting officers authorised by each Party. The licence and the certified true copies shall correspond to one or either of the models set out in Appendix ROAD.A.1.3 of Part A to Annex ROAD-1, which also lays down the conditions governing its use. The licence shall contain at least two of the security features listed in Appendix ROAD.A.1.4 to Part A of Annex ROAD-1.
4. Road haulage operators shall comply with the requirements set out in Section 2 of Part A of Annex ROAD-1 laying down requirements for the posting of drivers when undertaking a journey referred to in Article ROAD.4(3)-(7) [Transport of goods between, through and within the territories of the Parties].

#### Article ROAD.6: Exemptions from licencing requirement

The following types of transport of goods and unladen journeys made in conjunction with such transport may be conducted without a valid licence as referred to in Article 5 [Requirements for operators]:

- (a) transport of mail as a universal service;
- (b) transport of vehicles which have suffered damage or breakdown;
- (c) until 20 February 2022, transport of goods in motor vehicles the permissible laden mass of which, including that of trailers, does not exceed 3.5 tonnes;
- (d) from 21 February 2022, transport of goods in motor vehicles the permissible laden mass of which, including that of trailers, does not exceed 2.5 tonnes;
- (e) transport of medicinal products, appliances, equipment and other articles required for medical care in emergency relief, in particular for natural disasters and humanitarian assistance;
- (f) transport of goods in vehicles provided that the following conditions are fulfilled:
  - (i) the goods carried are the property of the road haulage operator or have been sold, bought, let out on hire or hired, produced, extracted, processed or repaired by the operator;
  - (ii) the purpose of the journey is to carry the goods to or from the road haulage operator's premises or to move them, either inside or outside the operator for its own requirements;
  - (iii) the vehicles used for such transport are driven by personnel employed by, or put at the disposal of, the road haulage operator under a contractual obligation;
  - (iv) the vehicles carrying the goods are owned by the road haulage operator, have been bought by it on deferred terms or have been hired; and
  - (v) such transport is no more than ancillary to the overall activities of the road haulage operator;
- (g) transport of goods by means of motor vehicles with a maximum authorised speed not exceeding 40 km/h.

#### Article ROAD.7: Requirements for drivers

1 Drivers of the vehicles undertaking journeys as referred to in Article ROAD.4 [Transport of goods between, through and within the territories of the Parties] shall:

- (a) hold a Certificate of Professional Competence issued in accordance with Section 1 of Part B of Annex ROAD- 1; and

(b) comply with the rules on driving and working time, rest periods, breaks and the use of tachographs in accordance with Sections 2 to 4 of Part B of Annex ROAD-1.

2. The European Agreement concerning the Work of Crews of Vehicles Engaged in International Road Transport (AETR) done in Geneva on 1 July 1970 shall apply, instead of point (b) of paragraph 1, to international road transport operations undertaken in part outside the territory of the Parties, for the whole journey.

#### Article ROAD.8: Requirements for vehicles

1. A Party shall not reject or prohibit the use in its territory of a vehicle undertaking a journey referred to in Article ROAD.4 [Transport of goods between, through and within the territories of the Parties] if the vehicle complies with the requirements set out in Section 1 of Part C of Annex ROAD-1.

2. Vehicles undertaking the journeys referred to in Article ROAD.4 [Transport of goods between, through and within the territories of the Parties] shall be equipped with a tachograph constructed, installed, used, tested and controlled in accordance with Section 2 of Part C of Annex ROAD-1.

#### Article ROAD.9: Road traffic rules

Drivers of vehicles undertaking the transport of goods under this Title shall, when in the territory of the other Party, comply with the national laws and regulations in force in that territory concerning road traffic.

#### Article ROAD.10: Development of laws and Specialised Committee on Road Transport

1. When a Party proposes a new regulatory measure in an area covered by Annex ROAD-1, it shall:

- (a) notify the other Party of the proposed regulatory measure as soon as possible; and
- (b) keep the other Party informed of progress of the regulatory measure.

2. At the request of one of the Parties, an exchange of views shall take place within the Specialised Committee on Road Transport no later than two months after the submission of the request, as to whether the proposed new regulatory measure would apply to journeys referred to in Article ROAD.4 [Transport of goods between, through and within the territories of the Parties], or not.

3. When a Party adopts a new regulatory measure referred to in paragraph 1, it shall notify the other Party, and supply the text of the new regulatory measure within one week of its publication.

4. The Specialised Committee on Road Transport shall meet to discuss any new regulatory measure adopted, on request by either Party within two months of the submission of the request, whether or not a notification has taken place in accordance with paragraph 1 or 3, or a discussion has taken place in accordance with paragraph 2.

5. The Specialised Committee on Road Transport may:

- (a) amend Annex ROAD-1 to take account of regulatory and/or technological developments, or to ensure the satisfactory implementation of this Title;

- (b) confirm that the amendments made by the new regulatory measure conform to Annex ROAD-1; or
- (c) decide on any other measure aimed at safeguarding the proper functioning of this Title.

#### Article ROAD.11: Remedial measures

1 If a Party considers that the other Party has adopted a new regulatory measure that does not comply with the requirements of Annex ROAD-1, in particular in cases where the Specialised Committee on Road Transport has not reached a decision under Article 10(5) [Development of laws and Specialised Committee on Road Transport], and the other Party nevertheless applies the provisions of the new regulatory measure to the Party's road transport operators, drivers or vehicles, the Party may, after notifying the other Party, adopt appropriate remedial measures, including the suspension of obligations under this Agreement or any supplementing Agreement, provided that such measures:

- (a) do not exceed the level equivalent to the nullification or impairment caused by the new regulatory measure adopted by the other Party that does not comply with the requirements of Annex ROAD-1; and
- (b) take effect at the earliest 7 days after the Party which intends to take such measures has given the other Party notice under this paragraph.

2. The appropriate remedial measures shall cease to apply:

- (a) when the Party having taken such measures is satisfied that the other Party is complying with its obligations under this Title; or
- (b) in compliance with a ruling of the arbitration tribunal.

3. A Party shall not invoke the WTO Agreement or any other international agreement to preclude the other Party from suspending obligations under this Article.

#### Article ROAD.12: Taxation

1. Vehicles used for the carriage of goods in accordance with this Title shall be exempt from the taxes and charges levied on the possession or circulation of vehicles in the territory of the other Party.

2. The exemption referred to in paragraph 1 shall not apply to:

- (a) a tax or charge on fuel consumption;
- (b) a charge for using a road or network of roads; or
- (c) a charge for using particular bridges, tunnels or ferries.

3. The fuel contained in the standard tanks of the vehicles and of special containers, admitted temporarily, which is used directly for the purpose of propulsion and, where appropriate, for the operation, during transport, of refrigeration systems and other systems, as well as lubricants present in the motor vehicles and required for their normal operation during the journey, shall be free of



custom duties and any other taxes and levies, such as VAT and excise duties, and shall not be subject to any import restrictions.

4. The spare parts imported for repairing a vehicle on the territory of one Party that has been registered or put into circulation in the other Party, shall be admitted under cover of a temporary duty-free admission and without prohibition or restriction of importation. The replaced parts are subject to customs duties and other taxes (VAT) and shall be re-exported or destroyed under the control of the customs authorities of the other Party.

#### Article ROAD.13: Obligations in other Titles

Articles SERVIN 3.2 [Market access] and SERVIN 3.4 [National treatment] of Chapter three of Title II of Heading one of Part two are incorporated into and made part of this Title and apply to the treatment of road haulage operators undertaking journeys in accordance with Article ROAD.4 [Transport of goods between, through and within the territories of the Parties].

#### Article ROAD.14: Termination of this Title

5. Without prejudice to Article FINPROV.8 [Termination], Article OTH.10 [Termination of Part Two] and Article FISH.17 [Termination], each Party may at any moment terminate this Title, by written notification through diplomatic channels. In that event, this Title shall cease to be in force on the first day of the ninth month following the date of notification.

### *TITLE II: TRANSPORT OF PASSENGERS BY ROAD*

#### Article X: Scope

1. The objective of this Title is to ensure, as regards the transport of passengers by road, continued connectivity between, through and within the territories of the Parties and to lay down the rules which are applicable to such transport. It applies to the occasional, regular and special regular transport of passengers by coach and bus between, through and within the territories of the Parties.

2. The Parties agree not to take discriminatory measures when applying this Title.

3. Nothing in this Title shall affect the transport of passengers within the territory of one of the Parties by a road passenger transport operator established in that territory.

#### Article X+1 :Definitions

For the purposes of this Title and in addition to the definitions set out in Article SERVIN 1.2 [Definitions] of Chapter one of Title II of Heading one of Part Two [Services and Investment], the following definitions apply:

- (a) “coaches and buses” are vehicles which, by virtue of their construction and their equipment, are suitable for carrying more than nine persons, including the driver, and are intended for that purpose;
- (b) “passenger transport services” means transport services by road for the public or for specific categories of users, supplied in return for payment by the person transported or by the transport organiser, by means of coaches and buses;

- (c) “road passenger transport operator” means any natural person or any legal person, whether having its own legal personality or being dependent upon an authority having such a personality, which supplies passenger transport services;
- (d) “road passenger transport operator of a Party” means a road passenger transport operator which is established in the territory of a Party or a natural person of a Party;
- (e) “regular services” means passenger transport services supplied at specified frequency along specified routes, whereby passengers may be picked up and set down at predetermined stopping points;
- (f) “special regular services” means services by whomsoever organised, which provide for the transport of specified categories of passengers to the exclusion of other passengers, in so far as such services are operated under the conditions specified for regular services. Special regular services shall include:
  - (i) the transport of workers between home and work, and
  - (ii) the transport of school pupils and students to and from the educational institution.

The fact that a special regular service may be varied according to the needs of users shall not affect its classification as a regular service;

- (g) “group” means any of the following:
  - (i) one or more associated natural or legal persons and their parent natural or legal person or persons;
  - (ii) one or more associated natural person or legal persons which have the same parent natural or legal person or persons;
- (h) “Interbus Agreement” means the Agreement on the international occasional carriage of passengers by coach and bus, as subsequently amended, which entered into force on 1 January 2003;
- (i) “transit” means the movement of coaches and buses across the territory of a Party without picking up or setting down of passengers;
- (j) “occasional services” means services which are not regular services or special regular services, and which are characterised above all by the fact that they carry groups of passengers assembled at the initiative of the customer or the road passenger transport operator.

#### Article X+2: Passenger transport by coach and bus between, through and within the territories of the Parties

1. Road passenger transport operators of a Party may, when operating regular and special regular services, undertake laden journeys from the territory of a Party to the territory of the other Party, with or without transit through the territory of a third country, and unladen journeys related to such journeys.

2. Road passenger transport operators of a Party may, when operating regular and special regular services, undertake laden journeys from the territory of the Party, in which the road passenger transport operator is established, to the territory of the same Party with transit through the territory of the other Party, and unladen journeys related to such journeys.
3. A road passenger transport operator of a Party may not operate regular or special regular services with both origin and destination in the territory of the other Party.
4. Where the passenger transport service referred to in paragraph 1 is part of a service to or from the territory of the Party where the road passenger transport operator is established, passengers may be picked up or set down in the territory of the other Party *en route*, provided the stop is authorised in accordance with the rules applicable in that territory.
5. Where the passenger transport service referred to in this Article is part of an international regular or special regular service between Ireland and the United Kingdom in respect of Northern Ireland, passengers may be picked up and set down in one Party by a road passenger transport operator established in the other Party.
6. Road passenger transport operators established in the territory of one Party may, on a temporary basis, operate occasional services on the island of Ireland which pick up and set down passengers on the territory of the other Party.
7. Road passenger transport operators may, when operating occasional services, undertake a laden journey from the territory of a Party through the territory of the other Party to the territory of a non-Contracting Party to the Interbus Agreement, including a related unladen journey.
8. The passenger transport services referred to in this Article shall be performed using coaches and buses registered in the Party where the road passenger transport operator is established or resides. Those coaches and buses shall comply with the technical standards laid down in Annex 2 to the Interbus Agreement.

Article X+3: Conditions for the provision of services referred to in Article X+2

1. Regular services shall be open to all road passenger transport operators of a Party, subject to compulsory reservation, where appropriate.
2. Regular and special regular services shall be subject to authorisation in accordance with Article X+4, and paragraph 6.
3. The regular nature of the service shall not be affected by any adjustment to the service operating conditions.
4. The organisation of parallel or temporary services serving the same public as existing regular services, the non-serving of certain stops and the serving of additional stops on existing regular services shall be governed by the same rules as those applicable to existing regular services.
5. Sections V (Social provisions) and VI (Custom and fiscal provisions) of the Interbus Agreement as well as Annexes I (Conditions applying to road passenger transport operators) and II (Technical standards applying to buses and coaches) thereto shall apply.

6. For a period of six months from the date of entry into force of this Agreement, special regular services shall not be subject to authorisation where they are covered by a contract concluded between the organiser and the road passenger transport operator.

7. Occasional services covered by this Title in accordance with Article X+(2) shall not require authorisation. However, the organisation of parallel or temporary services comparable to existing regular services and serving the same public as the latter shall be subject to authorisation in accordance with Section VIII of the Interbus Agreement.

#### Article X+4: Authorisation

1. Authorisations for services referred to in Article X+2 shall be issued by the competent authority of the Party in whose territory the road passenger transport operator is established (the "authorising authority").

2. If a road passenger transport operator is established in the Union, the authorising authority shall be the competent authority of the Member State of origin or destination.

3. In the case of a group of road passenger transport operators intending to operate a service referred to in Article X+2, the authorising authority shall be the competent authority to which the application is addressed in accordance with the second part of Article X+5(1).

4. Authorisations shall be issued in the name of the road passenger transport operator and shall be non-transferable. However, a road passenger transport operator of a Party who has received an authorisation may, with the consent of the authorising authority, operate the service through a subcontractor, if such a possibility is in line with the law of the Party. In this case, the name of the subcontractor and its role shall be indicated in the authorisation. The subcontractor shall be a road passenger transport operator of a Party and shall comply with all the provisions of this Title.

In the case of a group of road passenger transport operators that intend to operate services referred to in Article X+2, the authorisation shall be issued in the names of all the road passenger transport operators of the group and shall state the names of all those operators. It shall be given to the road passenger transport operators entrusted by the other road passenger transport operators of a Party for these purposes and which has requested it, and certified true copies shall be given to the other road passenger transport operators.

5. Without prejudice to Article X+6(3), the period of validity of an authorisation shall not exceed five years. It may be set for a shorter period either at the request of the applicant or by mutual consent of the competent authorities of the Parties on whose territories passengers are picked up or set down.

6. Authorisations shall specify the following:

- (a) the type of service;
- (b) the route of the service, giving in particular the point of departure and the point of arrival;
- (c) the period of validity of the authorisation; and
- (d) the stops and the timetable.

7. Authorisations shall conform to the model set out in Annex ROAD-2.

8. The road passenger transport operator of a Party carrying out a service referred to in Article X+2 may use additional vehicles to deal with temporary and exceptional situations. Such additional vehicles may be used only under the same conditions as set out in the authorisation referred to in paragraph 6.

In this case, in addition to the documents referred to in Article X+10(1) and (2), the road passenger transport operator shall ensure that a copy of the contract between the road passenger transport operator carrying out the regular or special regular service and the undertaking providing the additional vehicles or an equivalent document is carried in the vehicle and presented at the request of any authorised inspecting officer.

#### Article X+5: Submission of application for authorisation

1. Applications for authorisation shall be submitted by the road passenger transport operator of a Party to the authorising authority referred to in Article X+4(1).

For each service, only one application shall be submitted. In the cases referred to in Article X+4(3), it shall be submitted by the operator entrusted by the other operators for these purposes. The application shall be addressed to the authorising authority of the Party in which the road passenger transport operator submitting it is established.

2. Applications for authorisation shall be submitted on the basis of the model set out in Annex ROAD-3.

3. The road passenger transport operator applying for authorisation shall provide any further information which it considers relevant or which is requested by the authorising authority, in particular, the documents listed in Annex ROAD-3.

#### Article X+6: Authorisation procedure

1. Authorisations shall be issued in agreement with the competent authorities in the Parties in whose territory passengers are picked up or set down. The authorising authority shall forward to such competent authorities, as well as to the competent authorities whose territories are crossed without passengers being picked up or set down, a copy of the application, together with copies of any other relevant documentation, and its assessment.

In respect of the Union, the competent authorities referred to in the first part of this paragraph shall be those of the Member States in whose territories passengers are picked up or set down and whose territories are crossed without passengers being picked up or set down.

2. The competent authorities whose agreement has been requested shall notify the authorising authority of their decision regarding the application within four months. This time limit shall be calculated from the date of receipt of the request for agreement which is shown in the acknowledgement of receipt. If the decision received from the competent authorities whose agreement has been requested is negative, it shall contain a proper statement of reasons. If the authorising authority does not receive a reply within four months, the competent authorities consulted shall be deemed to have given their agreement and the authorising authority may grant the authorisation.

The competent authorities whose territory is crossed without passengers being picked up or set down may notify the authorising authority of their comments within four months.

3. In respect of services that had been authorised under Regulation (EC) No 1073/2009 of the European Parliament and Council<sup>70</sup> before the end of the transition period and in respect of which the authorisation lapses at the end of the transition period, the following shall apply:

- (a) where, subject to the changes necessary to comply with Article X+2, the operating conditions are the same as those having been set in the authorisation granted under Regulation (EC) No 1073/2009, the relevant authorising authority under this Title may, on application or otherwise, issue the road transport operator with a corresponding authorisation granted under this Title. Where such an authorisation is issued, the agreement of the competent authorities in whose territories passengers are picked up or set down, as referred to in paragraph 2, shall be deemed to be provided. Those competent authorities and the competent authorities whose territory is crossed without passengers being picked up or set down may, at any time, notify the authorising authority of any comments they may have;
- (b) where point (a) is applied, the validity period of the corresponding authorisation granted under this Title shall not extend beyond the last day of the validity period specified in the authorisation previously granted under Regulation (EC) No 1073/2009.

4. The authorising authority shall take a decision on the application no later than six months from the date of submission of the application by the road passenger transport operator.

5. Authorisation shall be granted unless:

- (a) the applicant is unable to provide the service which is the subject of the application with equipment directly available to the applicant;
- (b) the applicant has not complied with national or international legislation on road transport, and in particular the conditions and requirements relating to authorisations for international road passenger services, or has committed serious infringements of a Party's road transport legislation in particular with regard to the rules applicable to vehicles and driving and rest periods for drivers;
- (c) in the case of an application for renewal of authorisation, the conditions of authorisation have not been complied with;
- (d) a Party decides on the basis of a detailed analysis that the service concerned would seriously affect the viability of a comparable service covered by one or more public service contracts conforming to the Party's law on the direct sections concerned. In such a case, the Party shall set up criteria, on a non-discriminatory basis, for determining whether the service applied for would seriously affect the viability of the abovementioned comparable service and shall communicate them to the other Party referred to in paragraph 1; or
- (e) a Party decides on the basis of a detailed analysis that the principal purpose of the service is not to carry passengers between stops located in the territories of the Parties.

---

<sup>70</sup> Regulation (EC) No 1073/2009 of the European Parliament and of the Council of 21 October 2009 on common rules for access to the international market for coach and bus services, and amending Regulation (EC) No 561/2006 (recast) (OJ EU L 300, 14.11.2009, p. 88).

In the event that an existing service seriously affects the viability of a comparable service covered by one or more public service contracts which conform to a Party's law on the direct sections concerned, due to exceptional reasons which could not have been foreseen at the time of granting the authorisation, a Party may, with the agreement of the other Party, suspend or withdraw the authorisation to run the international coach and bus service after having given six months' notice to the road passenger transport operator .

The fact that a road passenger transport operator of a Party offers lower prices than those offered by other road passenger transport operators or the fact that the link in question is already operated by other road passenger transport operators shall not in itself constitute justification for rejecting the application.

6. Having completed the procedure laid down in paragraphs 1 to 5, the authorising authority shall grant the authorisation or formally refuse the application.

Decisions rejecting an application shall state the reasons on which they are based. The Parties shall ensure that transport undertakings are given the opportunity to make representations in the event of their application being rejected.

The authorising authority shall inform the competent authorities of the other Party of its decision and shall send them a copy of any authorisation.

#### Article X+7: Renewal and alteration of authorisation

1. Article X+6 shall apply, *mutatis mutandis*, to applications for the renewal of authorisations or for alteration of the conditions under which the services subject to authorisation must be carried out.

2. Where the existing authorisation expires within six months from the date of entry into force of this Agreement, the period of time in which the competent authorities referred to in Article X+6(2) shall notify the authorising authority of their agreement to, or comments on, the application in accordance with that Article, is two months.

3. In the event of a minor alteration to the operating conditions, in particular the adjustment of intervals, fares and timetables, the authorising authority needs only supply the competent authorities of the other Party with information relating to the alteration. Changing the timetables or intervals in a manner that affects the timing of controls at the borders between the Parties or at third country borders shall not be considered a minor alteration.

#### Article X+8: Lapse of an authorisation

1. Without prejudice to Article X+6(3), an authorisation for a service referred to in Article X+2 shall lapse at the end of its period of validity or three months after the authorising authority has received notice from its holder of his or her intention to withdraw the service. Such notice shall contain a proper statement of reasons.

2. Where demand for a service has ceased to exist, the period of notice provided for in paragraph 1 shall be one month.

3. The authorising authority shall inform the competent authorities of the other Party concerned that the authorisation has lapsed.



4. The holder of the authorisation shall notify users of the service concerned of its withdrawal one month in advance by means of appropriate publicity.

#### Article X+9: Obligations of transport operators

1. Save in the event of *force majeure*, the road passenger transport operator of a Party carrying out a service referred to in Article X+2 shall launch the service without delay and, until the authorisation expires, take all measures to guarantee a transport service that fulfils the standards of continuity, regularity and capacity and complies with the conditions specified in accordance with Article X+4(6) and Annex ROAD-2.

2. The road passenger transport operator of a Party shall display the route of the service, the bus stops, the timetable, the fares and the conditions of carriage in such a way as to ensure that such information is readily available to all users.

3. It shall be possible for the Parties to make changes to the operating conditions governing a service referred to in Article X+2 by common agreement and in agreement with the holder of the authorisation.

#### Article X+10: Documents to be kept on the coach or bus

1. Without prejudice to Article X+4(8), the authorisation or a certified true copy thereof to carry out services referred to in Article X+2 and the operator's licence of the road passenger transport operator or a certified true copy thereof for the international carriage of passengers by road provided for according to national or Union law shall be kept on the coach or bus and shall be presented at the request of any authorised inspecting officer.

2. Without prejudice to paragraph 1 as well as to Article X+4(8), in the case of a special regular service, the contract between the organiser and the road passenger transport operator or a copy thereof as well as a document evidencing that the passengers constitute a specific category to the exclusion of other passengers for the purposes of a special regular service shall also serve as control documents, shall be kept in the vehicle and shall be presented at the request of any authorised inspecting officer.

3. Road passenger transport operators carrying out occasional services under Article X+2(6) and (7) shall carry a completed journey form, using the model in Annex ROAD-4. Books of journey forms shall be supplied by the competent authority of the territory in which the operator is registered, or by bodies appointed by the competent authority.

#### Article X+11: Road traffic rules

Drivers of coaches and buses undertaking the transport of passengers under this Title shall, when in the territory of the other Party, comply with the national laws and regulations in force in that territory concerning road traffic.

#### Article X+12: Application

The provisions of the present Title shall cease to apply as of the date the Protocol to the Interbus Agreement regarding the international regular and special carriage of passengers by coach and bus enters into force for the UK, or six months following the entry into force of that Protocol for the Union, whichever is the earliest, except for the purpose of the operations under Article X+2(2); Article X+2(5); Article X+2(6) and Article X+2(7).



#### Article X+13: Obligations in other Titles

Articles SERVIN 3.2 [Market access] and SERVIN 3.4 [National treatment] of Chapter three of Title II of Heading one of Part two are incorporated into and made part of this Title and apply to the treatment of transport operators undertaking journeys in accordance with Article X+2 of this Title.

#### Article X+14: Specialised Committee

The Specialised Committee on Road Transport may amend Annexes ROAD-2, ROAD-3 and ROAD-4 to take into account regulatory developments. It may adopt measures regarding the implementation of this Title.

## HEADING FOUR: SOCIAL SECURITY COORDINATION AND VISAS FOR SHORT-TERM VISITS

### *TITLE I: SOCIAL SECURITY COORDINATION*

#### Ch.SSC.1: Overview

Member States and the United Kingdom shall coordinate their social security systems in accordance with the Protocol on Social Security Coordination, in order to secure the social security entitlements of the persons covered therein.

#### Ch.SSC.2: Legally residing

1. The Protocol on Social Security Coordination shall apply to persons legally residing in a Member State or the United Kingdom.
2. Paragraph 1 of this Article shall not affect entitlements to cash benefits which relate to previous periods of legal residence of persons covered by Article SSC.2 [Persons covered] of the Protocol on Social Security Coordination.

#### Ch.SSC.3: Cross border situations

1. The Protocol on Social Security Coordination shall only apply to situations arising between one or more Member States of the Union and the United Kingdom.
2. The Protocol on Social Security Coordination shall not apply to persons whose situations are confined in all respects either to the United Kingdom, or to the Member States.

#### Ch.SSC.4: Immigration applications

The Protocol on Social Security Coordination shall apply without prejudice to the right of a Member State or the United Kingdom to charge a health fee under national legislation in connection with an application for a permit to enter, to stay, to work, or to reside in that State.

### *TITLE II: VISAS FOR SHORT-TERM VISITS*

#### Article VSTV.1: Visas for short-term visits

1. The Parties note that on the date of entry into force of this Agreement both Parties provide for visa-free travel for short-term visits in respect of their nationals in accordance with their domestic law. Each Party shall notify the other of any intention to impose a visa requirement for short-term visits by nationals of the other Party in good time and, if possible, at least three months before such a requirement takes effect.
2. Subject to paragraph 3 and to Article FINPROV.10 [future accessions to the Union], in the event that the United Kingdom decides to impose a visa requirement for short-term visits on nationals of a Member State, that requirement shall apply to the nationals of all Member States.
3. This Article is without prejudice to any arrangements made between the United Kingdom and Ireland concerning the Common Travel Area.

## HEADING FIVE: FISHERIES

### Chapter one: Initial provisions

#### Article FISH.1: Sovereign rights of coastal States exercised by the Parties

The Parties affirm that sovereign rights of coastal States exercised by the Parties for the purpose of exploring, exploiting, conserving and managing the living resources in their waters should be conducted pursuant to and in accordance with the principles of international law, including the United Nations Convention on the Law of the Sea of 10 December 1982.

#### Article FISH.2: Objectives and principles

1. The Parties shall cooperate with a view to ensuring that fishing activities for shared stocks in their waters are environmentally sustainable in the long term and contribute to achieving economic and social benefits, while fully respecting the rights and obligations of independent coastal States as exercised by the Parties.
2. The Parties share the objective of exploiting shared stocks at rates intended to maintain and progressively restore populations of harvested species above biomass levels that can produce the maximum sustainable yield.
3. The Parties shall have regard to the following principles:
  - (a) applying the precautionary approach to fisheries management;
  - (b) promoting the long-term sustainability (environmental, social and economic) and optimum utilisation of shared stocks;
  - (c) basing conservation and management decisions for fisheries on the best available scientific advice, principally that provided by the International Council for the Exploration of the Sea (ICES);
  - (d) ensuring selectivity in fisheries to protect juvenile fish and spawning aggregations of fish, and to avoid and reduce unwanted bycatch;
  - (e) taking due account of and minimising harmful impacts of fishing on the marine ecosystem and taking due account of the need to preserve marine biological diversity;
  - (f) applying proportionate and non-discriminatory measures for the conservation of marine living resources and the management of fisheries resources, while preserving the regulatory autonomy of the Parties;
  - (g) ensuring the collection and timely sharing of complete and accurate data relevant for the conservation of shared stocks and for the management of fisheries;
  - (h) ensuring compliance with fisheries conservation and management measures, and combating illegal, unreported and unregulated fishing; and
  - (i) ensuring the timely implementation of any agreed measures into the Parties' regulatory frameworks.

### Article FISH.3: Definitions

1. For the purposes of this Heading the following definitions apply:
  - (a) “EEZ” (of a Party) means, in accordance with the United Nations Convention on the Law of the Sea of 10 December 1982:
    - (i) in the case of the Union, the exclusive economic zones established by its Member States adjacent to their European territories;
    - (ii) the exclusive economic zone established by the United Kingdom;
  - (b) “precautionary approach to fisheries management” means an approach according to which the absence of adequate scientific information does not justify postponing or failing to take management measures to conserve target species, associated or dependent species and non-target species and their environment;
  - (c) “shared stocks” means fish, including shellfish of any kind that are found in the waters of the Parties, which includes molluscs and crustaceans;
  - (d) “TAC” means the total allowable catch, which is the maximum quantity of a stock (or stocks) of a particular description that may be caught over a given period;
  - (e) “non-quota stocks” means stocks which are not managed through TACs;
  - (f) “territorial sea” (of a Party) means, in accordance with the United Nations Convention on the Law of the Sea of 10 December 1982:
    - (i) in the case of the Union, by derogation from Article FINPROV.1(1) [Territorial scope], the territorial sea established by its Member States adjacent to their European territories;
    - (ii) the territorial sea established by the United Kingdom;
  - (g) “waters” (of a Party) means:
    - (i) in respect of the Union, by derogation from Article FINPROV.1(1)[Territorial scope], the EEZs of the Member States and their territorial seas;
    - (ii) in respect of the United Kingdom, its EEZ and its territorial sea, excluding for the purposes of Articles FISH.8 [Access to waters], FISH.9 [Compensatory measures in case of withdrawal or reduction of access] and Annex FISH.4 [Protocol on access to waters] the territorial sea adjacent to the Bailiwick of Guernsey, the Bailiwick of Jersey and the Isle of Man;
  - (h) “vessel” (of a Party) means:
    - (i) in the case of the United Kingdom, a fishing vessel flying the flag of the United Kingdom, registered in the United Kingdom, the Bailiwick of Guernsey, the Bailiwick of Jersey or the Isle of Man, and licensed by a UK fisheries administration;

- (ii) in the case of the Union, a fishing vessel flying the flag of a Member State and is registered in the Union.

## Chapter two: Conservation and sustainable exploitation

### Article FISH.4: Fisheries management

1. Each Party shall decide on any measures applicable to its waters in pursuit of the objectives set out in Article FISH.2(1) and (2)[Objectives and principles], and having regard to the principles referred to in Article FISH.2(3) [Objectives and principles].
2. A Party shall base the measures referred to in paragraph 1 on the best available scientific advice.

A Party shall not apply the measures referred to in paragraph 1 to the vessels of the other Party in its waters unless it also applies the same measures to its own vessels.

The second subparagraph is without prejudice to obligations of the Parties under the Port State Measures Agreement, the North East Atlantic Fisheries Commission Scheme of Control and Enforcement, the Northwest Atlantic Fisheries Organisation Conservation and Enforcement Measures, and the Recommendation 18-09 by International Commission for the Conservation of Atlantic Tunas on Port State Measures to Prevent, Deter and Eliminate Illegal, Unreported and Unregulated Fishing.

The Specialised Committee on Fisheries may amend the list of pre-existing international obligations referred to in the third subparagraph.

3. Each Party shall notify the other Party of new measures as referred to in paragraph 1 that are likely to affect the vessels of the other Party before those measures are applied, allowing sufficient time for the other Party to provide comments or seek clarification.

### Article FISH.5: Authorisations, compliance and enforcement

1. Where vessels have access to fish in the waters of the other Party pursuant to Article FISH.8 [Access to waters] and Article FISH.10 [Access to waters of the Bailiwick of Guernsey, the Bailiwick of Jersey and the Isle of Man]:
  - (a) each Party shall communicate in sufficient time to the other Party a list of vessels for which it seeks to obtain authorisations or licences to fish; and
  - (b) the other Party shall issue authorisations or licences to fish.
2. Each Party shall take all necessary measures to ensure compliance by its vessels with the rules applicable to those vessels in the other Party's waters, including authorisation or licence conditions.

## Chapter three: Arrangements on access to waters and resources

### Article FISH.6: Fishing opportunities

1. By 31 January of each year, the Parties shall cooperate to set the schedule for consultations with the aim of agreeing TACs for the stocks listed in Annex FISH.1 for the following year or years.

That schedule shall take into account other annual consultations among coastal States that affect either or both of the Parties.

2. The Parties shall hold consultations annually to agree, by 10 December of each year, the TACs for the following year for the stocks listed in Annex FISH.1. This shall include an early exchange of views on priorities as soon as advice on the level of the TACs is received. The Parties shall agree those TACs:

- (a) on the basis of the best available scientific advice, as well as other relevant factors, including socio-economic aspects; and
- (b) in compliance with any applicable multi-year strategies for conservation and management agreed by the Parties.

3. The Parties' shares of the TACs for the stocks listed in Annex FISH.1 shall be allocated between the Parties in accordance with the quota shares set out in that Annex.

4. Annual consultations may also cover, inter alia:

- (a) transfers of parts of one Party's shares of TACs to the other Party;
- (b) a list of stocks for which fishing is prohibited;
- (c) the determination of the TAC for any stock which is not listed in Annex FISH.1 or Annex FISH.2 and the Parties' respective shares of those stocks;
- (d) measures for fisheries management, including, where appropriate, fishing effort limits;
- (e) stocks of mutual interest to the Parties other than those listed in the Annexes to this Heading.

5. The Parties may hold consultations with the aim of agreeing amended TACs if either Party so requests.

6. A written record documenting the arrangements made between the Parties as a result of consultations under this Article shall be produced and signed by the heads of delegation of the Parties.

7. Each Party shall give sufficient notice to the other Party before setting or amending TACs for the stocks listed in Annex FISH.3.

8. The Parties agree to set up a mechanism for voluntary in-year transfers of fishing opportunities between the Parties, to take place each year. The Specialised Committee on Fisheries shall decide on the details of this mechanism. The Parties shall consider making transfers of fishing opportunities for stocks which are, or are projected to be, underfished available at market value through this mechanism.

#### Article FISH.7: Provisional TACs

1. If the Parties have not agreed a TAC for a stock listed in Annex FISH.1 or Annex FISH.2A or B by 10 December, they shall immediately resume consultations with the continued aim of agreeing the TAC. The Parties shall engage frequently with a view to exploring all possible options for reaching agreement in the shortest possible time.

2. If a stock listed in Annex FISH.1 or Annex FISH.2A and B remains without an agreed TAC on 20 December, each Party shall set a provisional TAC corresponding to the level advised by ICES, applying from 1 January.
3. By derogation from paragraph 2, the TACs for special stocks shall be set in accordance with guidelines adopted under paragraph 5.
4. For the purposes of this article, “special stocks” means:
  - (a) stocks where the ICES advice is for a zero TAC;
  - (b) stocks caught in a mixed fishery, if that stock or another stock in the same fishery is vulnerable; or
  - (c) other stocks which the Parties consider require special treatment.
5. The Specialised Committee on Fisheries shall adopt guidelines by 1 July 2021 for the setting of provisional TACs for special stocks.
6. Each year when advice is received from ICES on TACs, the Parties shall discuss, as a priority, the special stocks and the application of any guidelines set under paragraph 5 to the setting of provisional TACs by each Party.
7. Each Party shall set its share for each of the provisional TACs, which shall not exceed its share as set out in the corresponding Annex.
8. The provisional TACs and shares referred to in paragraphs 2, 3 and 7 shall apply until agreement is reached under paragraph 1.
9. Each Party shall, immediately, notify the other Party of its provisional TACs under paragraphs 2 and 3 and its provisional share of each of those TACs under paragraph 7.

#### Article FISH.8: Access to waters

1. Provided that TACs have been agreed each Party shall grant vessels of the other Party access to fish in its waters in the relevant ICES sub-areas that year. Access shall be granted at a level and on conditions determined in those annual consultations.
2. The Parties may agree, in annual consultations, further specific access conditions in relation to:
  - (a) the fishing opportunities agreed;
  - (b) any multi-year strategies for non-quota stocks developed under point (c) of Article FISH.16(1) [Specialised Committee on Fisheries]; and
  - (c) any technical and conservation measures agreed by the Parties, without prejudice to Article FISH.4 [Fisheries management].

3. The Parties shall conduct the annual consultations, including on the level and conditions of access referred to in paragraph 1 of this Article, in good faith and with the objective of ensuring a mutually satisfactory balance between the interests of both Parties.

4. In particular, the outcome of the consultations should normally result in each Party granting:

- (a) access to fish the stocks listed in Annex FISH.1 and Annex FISH.2.A, B and F in each other's EEZ (or if access is granted under point (c), in EEZs and in the divisions mentioned in that point) at a level that is reasonably commensurate with the Parties' respective shares of the TACs;
- (b) access to fish non-quota stocks in each other's EEZ (or if access is granted under point (c), in EEZs and in the divisions mentioned in that point), at a level that at least equates to the average tonnage fished by that Party in the waters of the other Party during the period 2012-2016; and
- (c) access to the waters of the Parties between six and twelve nautical miles from the baseline in ICES divisions 4c and 7d-g for qualifying vessels to the extent that Union fishing vessels and United Kingdom fishing vessels had access to those waters on 31 December 2020.

For the purposes of point (c), 'qualifying vessel' means a vessel of a Party which fished in the zone mentioned in the previous sentence in four of the years between 2012 and 2016, or its direct replacement.

Annual consultations referred to in point (c) may include appropriate financial commitments and quota transfers between the Parties.

5. During the application of a provisional TAC, and pending an agreed TAC, the Parties shall grant provisional access to fish in the relevant ICES sub-areas as follows

- (a) for stocks listed in Annex FISH.1 and non-quota stocks, from 1 January until 31 March at the levels provided for in paragraph 4(a) and (b);
- (b) for stocks listed in Annex FISH.2 from 1 January until 14 February at the levels provided for in paragraph 4(a); and
- (c) in relation to access to fish in the six to twelve nautical miles zone, access in accordance with paragraph 4(c) from 1 January to 31 January at a level equivalent to the average monthly tonnage fished in that zone in the previous 3 months.

Such access, for each of the relevant stocks in points (a) and (b), shall be in proportion to the average percentage of a Party's share of the annual TAC which that Party's vessels fished in the other Party's waters in the relevant ICES sub-areas during the same period of the previous three calendar years. The same shall apply, *mutatis mutandis*, to access to fish non-quota stocks.

By 15 January in relation to the situation in point (c) of this paragraph, by 31 January in respect of the stocks listed in Annex FISH.2, and by 15 March in respect of all other stocks, each Party shall notify the other Party of the change in the level and conditions of access to waters that will apply as of 1 February in relation to the situation in point (c), as of 15 February in respect of the stocks listed in Annex FISH.2, and as of 1 April in respect of all other stocks for the relevant ICES sub-areas.

6. Without prejudice to Article FISH.7(1) and (8)[Provisional TACs], after the period of one month in relation to the situation in point (c) of paragraph 5, one and a half months in respect of the



stocks listed in Annex FISH.2 and three months in respect of all other stocks, the Parties shall seek to agree further provisional access arrangements at the appropriate geographical level with the aim of minimising disruption to fishing activities.

7. In granting access under paragraph 1, a Party may take into account compliance of individual or groups of vessels with the applicable rules in its waters during the preceding year, and measures taken by the other Party pursuant to Article FISH.5(2) [Authorisations, compliance and enforcement] during the preceding year.

8. This Article shall apply subject to Annex FISH.4 [Protocol on access to waters].

#### Article FISH.9: Compensatory measures in case of withdrawal or reduction of access

1. Following a notification by a Party (“host Party”) under Article FISH.8(5)[Access to waters], the other Party (“fishing Party”) may take compensatory measures commensurate to the economic and societal impact of the change in the level and conditions of access to waters. Such impact shall be measured on the basis of reliable evidence and not merely on conjecture and remote possibility. Giving priority to those compensatory measures which will least disturb the functioning of this Agreement, the fishing Party may suspend, in whole or in part, access to its waters and the preferential tariff treatment granted to fishery products under Article GOODS.5[Prohibition and customs duties].

2. A compensatory measure referred to in paragraph 1 may take effect at the earliest seven days after the fishing Party has given notice to the host Party of the intended suspension under paragraph 1 and, in any case, not earlier than 1 February in relation to the situation in point (c) of Article 8(5)[Access to waters], 15 February in respect of Annex FISH.2 and 1 April in respect of other stocks. The Parties shall consult within the Specialised Committee with a view to reaching a mutually agreeable solution. That notification shall identify:

- (a) the date upon which the fishing Party intends to suspend; and
- (b) the obligations to be suspended and the level of the intended suspension.

3. After the notification of the compensatory measures in accordance with paragraph 2, the host Party may request the establishment of an arbitration tribunal pursuant to Article INST.14 [Arbitration procedure] of Title I [Dispute settlement] of Part Six, without having recourse to consultations in accordance with Article INST.13 [Consultations]. The arbitration tribunal may only review the conformity of the compensatory measures with paragraph 1. The arbitration tribunal shall treat the issue as a case of urgency for the purpose of Article INST.19 [Urgent proceedings] of Title I [Dispute settlement] of Part Six.

4. When the conditions for taking compensatory measures referred to in paragraph 1 are no longer met, such measures shall be withdrawn immediately.

5. Following a finding against the fishing Party in the procedure referred to in paragraph 3, the host Party may request the arbitration tribunal, within 30 days from its ruling, to determine a level of suspension of obligations under this Agreement not exceeding the level equivalent to the nullification or impairment caused by the application of the compensatory measures, if it finds that the inconsistency of the compensatory measures with paragraph 1 is significant. The request shall propose a level of suspension in accordance with the principles set out in paragraph 1 and any

relevant principles set out in Article INST.34C [Suspension of obligations for the purposes of LPFS.3.12(12), Article FISH.9(5) and Article FISH.14(7)]. The host Party may apply the level of suspension of obligations under this Agreement in accordance with the level of suspension determined by the arbitration tribunal, no sooner than 15 days following such ruling.

6. A Party shall not invoke the WTO Agreement or any other international agreement to preclude the other Party from suspending obligations under this Article.

Article FISH.10: Access to waters of the Bailiwick of Guernsey, the Bailiwick of Jersey and the Isle of Man

1. By derogation from Articles FISH.8(1) and (3) to (7) [Access to waters], FISH.9 [Compensatory measures in case of withdrawal or reduction of access] and Annex FISH.4 [Protocol on access to waters], each Party shall grant vessels of the other Party access to fish in its waters reflecting the actual extent and nature of fishing activity that it can be demonstrated was carried out during the period beginning on 1 February 2017 and ending on 31 January 2020 by qualifying vessels of the other Party in the waters and under any treaty arrangements that existed on 31 January 2020.

2. For the purposes of this Article and, in so far as the other Articles in this Heading apply in relation to the arrangements for access established under this Article:

(a) "qualifying vessel" means, in respect of fishing activity carried out in waters adjacent to the Bailiwick of Guernsey, the Bailiwick of Jersey, the Isle of Man or a Member State, any vessel which fished in the territorial sea adjacent to that territory or that Member State on more than 10 days in any of the three 12 month periods ending on 31 January on, or between, 1 February 2017 and 31 January 2020;

(b) "vessel" (of a Party)" means, in respect of the United Kingdom, a fishing vessel flying the flag of the United Kingdom and registered in the Bailiwick of Guernsey, the Bailiwick of Jersey or the Isle of Man, and licensed by a United Kingdom fisheries administration;

(c) "waters" (of a Party) means:

(i) in respect of the Union, the territorial sea adjacent to a Member State; and

(ii) in respect of the United Kingdom, the territorial sea adjacent to each of the Bailiwick of Guernsey, the Bailiwick of Jersey and the Isle of Man.

3. At the request of either Party, the Partnership Council shall decide, within 90 days of the entry into force of this Agreement, that this Article, Article FISH.11 [Notification periods relating to the importation and direct landing of fisheries products] and any other provisions of this Heading in so far as they relate to the arrangements provided for in those Articles as well as paragraphs 3 to 5 of Article OTH.9 [Geographical application] shall cease to apply in respect of one or more of Bailiwick of Guernsey, the Bailiwick of Jersey and the Isle of Man, following 30 days from this decision.

4. The Partnership Council may decide to amend this Article, Article FISH.11 [Notification periods relating to the importation and direct landing of fisheries products] and any other provisions of this Heading in so far as they relate to the arrangements provided for in those Articles.

#### Article FISH.11: Notification periods relating to the importation and direct landing of fisheries products

1. The Union shall apply the following notification periods to fisheries products caught by vessels flying the flag of the United Kingdom and registered in the Bailiwick of Guernsey or the Bailiwick of Jersey in the territorial sea adjacent to those territories or in the territorial sea adjacent to a Member State:
  - (a) prior notification between three and five hours before landing fresh fisheries products into the Union's territory;
  - (b) prior notification between one and three hours of the validated catch certificate for the direct movement of consignments of fisheries products by sea before the estimated time of arrival at the place of entry into the Union's territory.
2. For the purposes of this Article only, "fisheries products" means all species of marine fish, molluscs and crustaceans.

#### Article FISH.12: Alignment of management areas

1. By 1 July 2021, the Parties shall request advice from ICES on the alignment of the management areas and the assessment units used by ICES for the stocks marked with an asterisk in Annex FISH.1.
2. Within six months of receipt of the advice referred to in paragraph 1, the Parties shall jointly review that advice and shall jointly consider adjustments to the management areas of the stocks concerned, with a view to agreeing consequential changes to the list of stocks and shares set out in Annex FISH.1.

#### Article FISH.13: Shares of TACs for certain other stocks

1. The Parties' respective shares of the TACs for certain other stocks are set out in Annex FISH.2.
2. Each Party shall notify the relevant States and international organisations of its shares in accordance with the sharing arrangement set out in Annex FISH.2A to D.
3. Any subsequent changes to those shares in Annex FISH.2C and D are a matter for the relevant multilateral fora.
4. Without prejudice to the powers of the Partnership Council in Article 16(3)[Specialised Committee on Fisheries], any subsequent changes to the shares Annex FISH.2A and B after 30 June 2026 are a matter for the relevant multilateral fora.
5. Both Parties shall approach the management of those stocks in Annex FISH.2A to D in accordance with the objectives and principles set out in Article FISH.2[Objectives and principles].

#### Chapter four: Arrangements on governance

## Article FISH.14: Remedial measures and dispute resolution

1. In relation to an alleged failure by a Party (“the respondent Party”) to comply with this Heading (other than in relation to alleged failures dealt with under paragraph 2), the other Party (“the complaining Party”) may, after giving notice to the respondent Party:

- (a) suspend, in whole or in part, access to its waters and the preferential tariff treatment granted to fishery products under Article GOODS.5[Prohibition of customs duties]; and
- (b) if it considers that the suspension referred to in point (a) is not commensurate to the economic and societal impact of the alleged failure, it may suspend, in whole or in part, the preferential tariff treatment of other goods under Article GOODS.5[Prohibition of customs duties]; and
- (c) if it considers that the suspension referred to in points (a) and (b) is not commensurate to the economic and societal impact of the alleged failure, it may suspend, in whole or in part, obligations under Heading One [Trade] of Part Two [Economic Partnership] with the exception of Title XI [Level Playing Field for open and fair competition and sustainable development]. If Heading One [Trade] is suspended in whole, Heading Three [Road Transport] is also suspended.

2. In relation to an alleged failure by a Party (the “respondent Party”) to comply with Article FISH.10 [Access to waters of the Bailiwick of Guernsey, the Bailiwick of Jersey and the Isle of Man], FISH.11 [Notification periods relating to the importation and direct landing of fisheries products] or any other provision of this Heading in so far as it relates to the arrangements provided for in those Articles, the other Party (“the complaining Party”), after giving notice to the respondent Party:

- (a) may suspend, in whole or in part, access to its waters within the meaning of Article FISH.10 [Access to waters of the Bailiwick of Guernsey, the Bailiwick of Jersey and the Isle of Man];
- (b) if it considers that the suspension referred to in point (a) is not commensurate to the economic and societal impact of the alleged failure, it may suspend, in whole or in part, the preferential tariff treatment granted to fisheries products under Article GOODS.5 [Prohibition of customs duties];
- (c) if it considers that the suspension referred to in points (a) and (b) is not commensurate to the economic and societal impact of the alleged failure, it may suspend, in whole or in part, the preferential tariff treatment of other goods under Article GOODS.5 [Prohibition of customs duties]; and

by way of derogation from paragraph 1, remedial measures affecting the arrangements established under Article FISH.10 [Access to waters of the Bailiwick of Guernsey, the Bailiwick of Jersey and the Isle of Man], Article FISH.11 [Notification periods relating to the importation and direct landing of fisheries products] or any other provision of this Heading in so far as it relates to the arrangements provided for in those Articles may not be taken as a result of an alleged failure by a Party to comply with provisions of the Heading unconnected to those arrangements.

3. Measures referred to paragraphs 1 and 2 shall be proportionate to the alleged failure by the respondent Party and the economic and societal impact thereof.

4. A measure referred to in paragraphs 1 and 2 may take effect at the earliest seven days after the complaining Party has given the respondent Party notice of the proposed suspension. The

Parties shall consult within the Specialised Committee on Fisheries with a view to reaching a mutually agreeable solution. That notification shall identify:

- (a) the way in which the complaining Party considers that the respondent Party has failed to comply;
- (b) the date upon which the complaining Party intends to suspend; and
- (c) the level of intended suspension.

5. The complaining Party must, within 14 days of the notification referred to in paragraph 4 challenge the alleged failure by the respondent Party to comply with this Heading, as referred to in paragraphs 1 and 2, by requesting the establishment of an arbitration tribunal under INST.14 [Arbitration Procedure] of Title I [Dispute settlement] of Part Six. Recourse to arbitration under this Article shall be made without having prior recourse to consultations under Article INST.13 [Consultations]. An arbitration tribunal shall treat the issue as a case of urgency for the purpose of Article INST.19 [Urgent proceedings] of Title I [Dispute settlement] of Part Six.

6. The suspension shall cease to apply when:

- (a) the complaining Party is satisfied that the respondent Party is complying with its relevant obligations under this Heading; or
- (b) the arbitration tribunal has decided that the respondent Party has not failed to comply with its relevant obligations under this Heading.

7. Following a finding against the complaining Party in the procedure referred to in paragraph 5, the respondent Party may request the arbitration tribunal, within 30 days from its ruling, to determine a level of suspension of obligations under this Agreement not exceeding the level equivalent to the nullification or impairment caused by the application of the compensatory measures, if it finds that the inconsistency of the compensatory measures with paragraphs 1 or 2 is significant. The request shall propose a level of suspension in accordance with paragraphs 1 or 2 and any relevant principles set out in Article INST.34C [Suspension of obligations for the purposes of OTHS.3.12(12), Article FISH.9(5) and Article FISH.14(7)]. The respondent Party may apply the level of suspension of obligations under this Agreement in accordance with the level of suspension determined by the arbitration tribunal, no sooner than 15 days following such ruling.

8. A Party shall not invoke the WTO Agreement or any other international agreement to preclude the other Party from suspending obligations under this Article.

#### Article FISH.15: Data sharing

The Parties shall share such information as is necessary to support the implementation of this Heading subject to each Party's laws.

#### Article FISH.16: Specialised Committee on Fisheries

1. The Specialised Committee on Fisheries may in particular:

- (a) provide a forum for discussion and co-operation in relation to sustainable fisheries management;

- (b) consider the development of multi-year strategies for conservation and management as the basis for the setting of TACs and other management measures;
- (c) develop multi-year strategies for the conservation and management of non-quota stocks as referred to in paragraph 2(b) of Article FISH.8 [Access to waters];
- (d) consider measures for fisheries management and conservation, including emergency measures and measures to ensure selectivity of fishing;
- (e) consider approaches to the collection of data for science and fisheries management purposes, the sharing of such data (including information relevant to monitoring, controlling and enforcing compliance), and the consultation of scientific bodies regarding the best available scientific advice;
- (f) consider measures to ensure compliance with the applicable rules, including joint control, monitoring and surveillance programmes and the exchange of data to facilitate monitoring uptake of fishing opportunities and control and enforcement;
- (g) develop the guidelines for setting the TACs referred to in paragraph 5 of Article FISH.7 [Provisional TACs];
- (h) make preparations for annual consultations;
- (i) consider matters relating to the designation of ports for landings, including the facilitation of the timely notification by the Parties of such designations and of any changes to those designations;
- (j) establish timelines for the notification of measures referred to in Article FISH.4(3) [Fisheries management], the communication of the lists of vessels referred to in Article FISH.5(1) [Authorisations, compliance and enforcement] and the notice referred to in Article FISH.6(7) [Fishing opportunities];
- (k) provide a forum for consultations under Article FISH.9(2) [Compensatory measures] and Article FISH.14(4) [Remedial measures];
- (l) develop guidelines to support the practical application of Article FISH.8 [Access to waters];
- (m) develop a mechanism for voluntary in-year transfers of fishing opportunities between the Parties, as referred to in Article FISH.6(8)[Fishing Opportunities]; and
- (n) consider the application and implementation of Article FISH.10 [Access to waters of the Bailiwick of Guernsey, the Bailiwick of Jersey and the Isle of Man] and Article FISH.11 [Notification periods relating to the importation and direct landing of fisheries products].

2. The Specialised Committee on Fisheries may adopt measures, including decisions and recommendations:

- (a) recording matters agreed by the Parties following consultations under Article FISH.6 [Fishing opportunities];
- (b) in relation to any of the matters referred to in points (b), (c), (d), (e), (f), (g), (i), (j), (l), (m) and (n) of paragraph 1 of this Article;

- (c) amending the list of pre-existing international obligations referred to in paragraph 2 of Article FISH.4 [Fisheries management]
  - (d) in relation to any other aspect of co-operation on sustainable fisheries management under this Heading; and
  - (e) on the modalities of a review under Article FISH.18[Review].
3. The Partnership Council shall have the power to amend Annexes FISH.1, FISH.2, and FISH.3.

#### Article FISH.17: Termination

1. Without prejudice to Article FINPROV.8 [Termination] or Article OTH.10 [Termination of Part Two], each Party may at any moment terminate this Heading, by written notification through diplomatic channels. In that event, Heading One [Trade], Heading Two [Aviation], Heading Three [Road transport] and this Heading [Fisheries] shall cease to be in force on the first day of the ninth month following the date of notification.
2. In the event of termination of this Heading pursuant to paragraph 1, Article FINPROV.8 [Termination] or Article OTH.10 [Termination of Part Two], obligations entered into by the Parties under this Heading for the year ongoing at the time when the Heading ceases to be in force shall continue to apply until the end of the year.
3. Notwithstanding paragraph 1, Heading Two [Aviation] may remain in force, if the Parties agree to integrate the relevant parts of Title XI [Level playing field for open and fair competition and sustainable development].
4. By way of derogation from paragraphs 1 to 3 and without prejudice to Article FINPROV.8 [Termination] or Article OTH.10 [Termination of Part Two]:
- (a) unless agreed otherwise between the Parties, Article FISH.10 [Access to waters of the Bailiwick of Guernsey, the Bailiwick of Jersey and the Isle of Man], Article FISH.11 [Notification periods relating to the importation and direct landing of fisheries products] and any other provision of this Heading in so far as it relates to the arrangements provided for in those Articles, shall remain in force until:
    - (i) they are terminated by either Party giving to the other Party three years' written notice of termination; or
    - (ii) if earlier, the date on which paragraphs 3 to 5 of Article OTH.9[Geographical application] cease to be in force;
  - (b) for the purposes of paragraph 4(a)(i), notice of termination may be given in respect of one or more of the Bailiwick of Guernsey, the Bailiwick of Jersey or the Isle of Man and Article FISH.10 [Access to waters of the Bailiwick of Guernsey, the Bailiwick of Jersey and the Isle of Man], Article FISH.11 [Notification periods relating to the importation and direct landing of fisheries products] and any other provision of this Heading in so far as it relates to the arrangements provided for in those Articles, shall continue to be in force for those territories in respect of which a notice of termination has not been given; and
  - (c) for the purposes of paragraph 4(a)(ii), if paragraphs 3 to 5 of Article OTH.9[Geographical application] of the Agreement cease to be in force in relation to one or more (but not all) of



the Bailiwick of Guernsey, the Bailiwick of Jersey or the Isle of Man, Article FISH.10 [Access to waters of the Bailiwick of Guernsey, the Bailiwick of Jersey and the Isle of Man], Article FISH.11 [Notification periods relating to the importation and direct landing of fisheries products] and any other provision of this Heading in so far as it relates to the arrangements provided for in those Articles, shall continue to be in force for those territories in respect of which paragraphs 3 to 5 of Article OTH.9 [Geographical application] remain in force.

#### Article FISH.18: Review clause

1. The Parties, within the Partnership Council, shall jointly review the implementation of this Heading four years after the end of the adjustment period referred to in the Article 1 of Annex FISH.4 [Protocol on access to waters] with the aim of considering whether arrangements, including in relation to access to waters, can be further codified and strengthened.
2. Such a review may be repeated at subsequent intervals of four years after the conclusion of the first review.
3. The Parties shall decide, in advance, on the modalities of the review through the Specialised Committee on Fisheries.
4. The review shall, in particular, allow for an evaluation, in relation to the previous years, of:
  - (a) the provisions for access to each other's waters under Article FISH.8 [Access to waters];
  - (b) the shares of TACs set out in the Annexes FISH.1, 2 and 3;
  - (c) the number and extent of transfers as part of annual consultations under Article FISH.6(4) [Fishing opportunities] and any transfers under Article FISH.6(8) [Fishing opportunities];
  - (d) the fluctuations in annual TACs;
  - (e) compliance by both Parties with the provisions of this Heading and the compliance by vessels of each Party with the rules applicable to those vessels when in the other Party's waters;
  - (f) the nature and extent of co-operation under this Heading; and
  - (g) any other element the Parties decide, in advance, through the Specialised Committee on fisheries.

#### Article FISH.19: Relationship with other agreements

1. Subject to paragraph 2, this Heading shall be without prejudice to other existing agreements concerning fishing by vessels of a Party within the area of jurisdiction of the other Party.
2. This Heading shall supersede and replace any existing agreements or arrangements with respect to fishing by Union fishing vessels in the territorial sea adjacent to the Bailiwick of Guernsey, the Bailiwick of Jersey or the Isle of Man and with respect to fishing by United Kingdom fishing vessels registered in the Bailiwick of Guernsey, the Bailiwick of Jersey or the Isle of Man in the territorial sea adjacent to a Member State. However, in case the Partnership Council has taken a decision in accordance with Article 10(3) [Access to waters of the Bailiwick of Guernsey, the Bailiwick of Jersey and the Isle of Man] for the Agreement to cease to apply in respect of the Bailiwick of Guernsey, the Bailiwick of Jersey or the Isle of Man, the relevant agreements or arrangements shall



not be superseded and replaced in respect of the territory or territories for which such a decision has been taken.

## HEADING SIX: OTHER PROVISIONS

### Article OTH.1: Definitions

Unless otherwise specified, for the purposes of Part Two of this Agreement, the Protocol on mutual administrative assistance in customs matters and the Protocol on administrative cooperation and combating fraud in the field of Value Added Tax and on mutual assistance for the recovery of claims relating to taxes and duties, the following definitions apply:

- (a) “agricultural good” means a product listed in Annex 1 to the Agreement on Agriculture;
- (b) “customs authority” means:
  - (i) with respect to the Union, the services of the European Commission responsible for customs matters or, as appropriate, the customs administrations and any other authorities empowered in the Member States to apply and enforce customs legislation, and
  - (ii) with respect to the United Kingdom, Her Majesty’s Revenue and Customs and any other authority responsible for customs matters.
- (c) “customs duty” means any duty or charge of any kind imposed on, or in connection with, the importation of a good but does not include:
  - (i) a charge equivalent to an internal tax imposed consistently with Article GOODS.4 [National Treatment on Internal Taxation and Regulation] of Title I of Heading One of Part Two;
  - (ii) an anti-dumping, special safeguard, countervailing or safeguard duty applied consistently with GATT 1994, the Anti-dumping Agreement, the Agreement on Agriculture, the Agreement on Subsidies and Countervailing Measures or the Agreement on Safeguards, as appropriate; or
  - (iii) a fee or other charge imposed on or in connection with importation that is limited in amount to the approximate cost of the services rendered;
- (d) “CPC” means the Provisional Central Product Classification (Statistical Papers Series M No.77, Department of International Economic and Social Affairs, Statistical Office of the United Nations, New York, 1991);
- (e) “existing” means in effect on the date of entry into force of this Agreement;
- (f) “goods of a Party” means domestic products within the meaning of GATT 1994, and includes originating goods of that Party;
- (g) “Harmonised System” or “HS” means the Harmonised Commodity Description and Coding System, including all legal notes and amendments thereto developed by the World Customs Organization;

- (h) “heading” means the first four digits in the tariff classification number under the Harmonised System;
- (i) “legal person” means any legal entity duly constituted or otherwise organised under applicable law, whether for profit or otherwise, and whether privately-owned or governmentally-owned, including any corporation, trust, partnership, joint venture, sole proprietorship or association;
- (j) “measure” means any measure by a Party, whether in the form of a law, regulation, rule, procedure, decision, administrative action, requirement or practice, or any other form;<sup>71</sup>
- (k) “measures of a Party” means any measures adopted or maintained by:
  - (i) central, regional or local governments or authorities; and
  - (ii) non-governmental bodies in the exercise of powers delegated by central, regional or local governments or authorities;

“measures of a Party” includes measures adopted or maintained by entities listed under subparagraphs (i) and (ii) by instructing, directing or controlling, either directly or indirectly, the conduct of other entities with regard to those measures;
- (l) “natural person of a Party” means<sup>72</sup>:
  - (i) for the European Union, a national of a Member State according to its law;<sup>73</sup> and
  - (ii) for the United Kingdom, a British citizen;
- (m) “person” means a natural person or a legal person;
- (n) “sanitary or phytosanitary measure” means any measure referred to in paragraph 1 of Annex A to the SPS Agreement;
- (o) “third country” means a country or territory outside the territorial scope of application of this Agreement;
- (p) “Vienna Convention on the Law of Treaties” means the Vienna Convention on the Law of Treaties, done at Vienna on 23 May 1969; and
- (q) “WTO” means the World Trade Organization.

#### Article OTH.2: WTO Agreements

For the purposes of this Agreement, the WTO Agreements are referred to as follows:

---

<sup>71</sup> For greater certainty, the term “measure” includes failures to act.

<sup>72</sup> This does not include natural persons residing in the territory referred to in Article FINPROV.1(3) [Territorial Scope].

<sup>73</sup> The definition of natural person also includes persons permanently residing in the Republic of Latvia who are not citizens of the Republic of Latvia or any other state but who are entitled, under the law of the Republic of Latvia, to receive a non-citizen’s passport.

- (a) “Agreement on Agriculture” means the Agreement on Agriculture, contained in Annex 1A to the WTO Agreement;
- (b) “Anti-dumping Agreement” means the Agreement on Implementation of Article VI of the General Agreement on Tariffs and Trade 1994;
- (c) “GATS” means the General Agreement on Trade in Services, contained in Annex 1B to the WTO Agreement;
- (d) “GATT 1994” means the General Agreement on Tariffs and Trade 1994, contained in Annex 1A to the WTO Agreement;
- (e) “GPA” means the Agreement on Government Procurement in Annex 4 to the WTO Agreement<sup>74</sup>;
- (f) “Safeguards Agreement” means the Agreement on Safeguards, contained in Annex 1A to the WTO Agreement;
- (g) “SCM Agreement” means the Agreement on Subsidies and Countervailing Measures, contained in Annex 1A to the WTO Agreement;
- (h) “SPS Agreement” means the Agreement on the Application of Sanitary and Phytosanitary Measures, contained in Annex 1A to the WTO Agreement;
- (i) “TBT Agreement” means the Agreement on Technical Barriers to Trade, contained in Annex 1A to the WTO Agreement;
- (j) “TRIPS Agreement” means the Agreement on Trade-Related Aspects of Intellectual Property Rights, contained in Annex 1C to the WTO Agreement; and
- (k) “WTO Agreement” means the Marrakesh Agreement Establishing the World Trade Organization, done at Marrakesh on 15 April 1994.

#### Article OTH.3: Establishment of a free trade area

The Parties hereby establish a free trade area, in conformity with Article XXIV of GATT 1994 and Article V of GATS.

#### Article OTH.4: Relation to the WTO Agreement

The Parties affirm their rights and obligations with respect to each other under the WTO Agreement and other agreements to which they are party.

Nothing in this Agreement shall be construed as requiring either Party to act in a manner inconsistent with its obligations under the WTO Agreement.

---

<sup>74</sup> For greater certainty, the ‘GPA’ shall be understood to be the GPA as amended by the Protocol Amending the Agreement on Government Procurement, done at Geneva on 30 March 2012.

#### Article OTH.4a: WTO case-law

The interpretation and application of the provisions of this Part shall take into account relevant interpretations in reports of WTO panels and of the Appellate Body adopted by the Dispute Settlement Body of the WTO as well as in arbitration awards under the Dispute Settlement Understanding.

#### Article OTH.5: Fulfilment of obligations

Each Party shall adopt any general or specific measures required to fulfil their obligations under this Part, including those required to ensure its observance by central, regional or local governments and authorities, as well as non-governmental bodies in the exercise of powers delegated to them.

#### Article OTH.7: References to laws and other Agreements

1. Unless otherwise specified, where reference is made in this Part to laws and regulations of a Party, those laws and regulations shall be understood to include amendments thereto.

2. Unless otherwise specified, where international agreements are referred to or incorporated into this Part, in whole or in part, they shall be understood to include amendments thereto or their successor agreements entering into force for both Parties on or after the date of signature of this Agreement. If any matter arises regarding the implementation or application of the provisions of this Part as a result of such amendments or successor agreements, the Parties may, on request of either Party, consult with each other with a view to finding a mutually satisfactory solution to this matter, as necessary.

#### Article OTH.8: Tasks of the Partnership Council in Part Two

The Partnership Council may:

- (a) adopt decisions to amend:
  - (i) Chapter two of Title I of Heading one of Part two [Rules of Origin] and its Annexes, in accordance with Article ORIG.31 [Amendment to this Chapter and its Annexes];
  - (ii) the arrangements set out in Annexes TBT-[XX] and TBT-[ZZ], in accordance with Article TBT.9(8) [Cooperation on market surveillance and non-food product safety and compliance];
  - (iii) Appendices A and B, in accordance with Article 2(3) [Product definitions, oenological practices and processes] of Annex TBT-5 [TRADE IN WINE];
  - (iv) Appendix C, in accordance with Article 3(3) [Certification requirements on import in the respective territories of the Parties] of Annex TBT-5 [TRADE IN WINE];
  - (v) Appendices A, B, C and D, in accordance with Article 1 [Objective and scope] of Annex TBT-4 [ORGANIC PRODUCTS];
  - (vi) Appendices 1 to 3, in accordance with Article 1 [Definitions] and Article 2 [Product scope] of Annex TBT-2 [MEDICINAL PRODUCTS];
  - (vii) the Annex on Authorised Economic Operators, the Protocol on mutual administrative assistance in customs matters, the Protocol on combating fraud in the field of Value

Added Tax and on mutual assistance for the recovery of claims relating to taxes and duties, and the list of goods set out in Article CUSTMS.16(2) [Temporary admission], in accordance with Article CUSTMS.21 [Amendments];

- (viii) the relevant Sub-section under Section B of ANNEX.PPROC-1, in accordance with Article PPROC.18 [Amendment of Section B of ANNEX.PPROC-1];
  - (ix) Annex ENER-1 [LISTS OF ENERGY GOODS, HYDROCARBONS AND RAW MATERIALS], Annex ENER-2 [ENERGY AND ENVIRONMENTAL SUBSIDIES] and Annex ENER-3 [NON-APPLICATION OF THIRD-PARTY ACCESS AND OWNERSHIP UNBUNDLING TO INFRASTRUCTURE], in accordance with Article ENER.31 [Effective implementation and amendments];
  - (x) Paragraph 4 of Article LPFS.3.2 [Scope and exceptions] in accordance with that paragraph, third sentence of paragraph 2 of Article LPFS.3.3 [Services of public economic interest] in accordance with the fourth sentence of that paragraph, paragraph 3 of Article LPFS.3.3 [Services of public economic interest] in accordance with that paragraph, Article LPFS.3.5 [Prohibited subsidies and subsidies subject to conditions] in accordance with paragraph 1 of that Article and Article LPFS.3.11 [Recovery] in accordance with paragraph 7 of that article, of Chapter 3 [Subsidy control];
  - (xi) Article FISH.10 [Bailiwick of Guernsey, Bailiwick of Jersey and the Isle of Man], Article FISH.11 [Notification periods relating to the importation and direct landing of fisheries products] and any other provision of Heading Five [Fisheries], in accordance with Article FISH.10(4) [Bailiwick of Guernsey, Bailiwick of Jersey and the Isle of Man];
  - (xii) Annexes FISH.1, FISH.2 and FISH.3, in accordance with Article FISH.16(3) [Specialised Committee on Fisheries];
  - (xiii) any other provision, protocol, appendix or annex, for which the possibility of such decision is explicitly foreseen in Part Two of this Agreement.
- (b) adopt decisions to issue interpretations of the provisions of Part Two of this Agreement.

#### Article OTH.9: Geographical application

1. The provisions of this Agreement concerning the tariff treatment of goods, including rules of origin and the temporary suspension of this treatment shall also apply, with respect to the Union, to those areas of the customs territory of the Union, as defined by Article 4 of Regulation (EU) No 952/2013 of the European Parliament and of the Council<sup>75</sup>, which are not covered by Article FINPROV.1(a) [Territorial scope] of Part Seven [Final provisions].

2. Without prejudice to Article FINPROV.1(2), (3) and (4) [Territorial Scope], the rights and obligations of the Parties under this Part shall also apply with regard to the areas beyond each Party's territorial sea, including the sea-bed and subsoil thereof, over which that Party exercises sovereign rights or jurisdiction in accordance with international law including the United Nations

---

<sup>75</sup> Regulation (EU) No 952/2013 of the European Parliament and of the Council of 9 October 2013 laying down the Union Customs Code (recast) (OJ EU L 269, 10.10.2013, p. 1).

Convention on the Law of the Sea, done at Montego Bay on 10 December 1982 and its laws and regulations which are consistent with international law.<sup>76</sup>

3. Subject to the exceptions contained in paragraph 4, Chapters 1 [NTMA], 2 [Rules of Origin] and 5 [Customs and trade facilitation] of Title IV [Trade in goods] and the Protocols and Annexes to those Chapters shall also apply, with respect to the United Kingdom, to the territories referred to in Article FINPROV.1(2) [Territorial scope]. For that purpose, the territories referred to in Article FINPROV.1(2) [Territorial scope] shall be considered as being part of the customs territory of the United Kingdom. The customs authorities of the territories referred to in Article FINPROV.1(2) [Territorial scope] shall be responsible for the application and implementation of these Chapters, and the Protocols and Annexes to these Chapters, in their respective territories. References to "customs authority" in those provisions shall be read accordingly. However, requests and communications made under these Chapters, and the Protocols and Annexes to these Chapters, shall be administered by the customs authority of the United Kingdom.

4. Article CUSTMS.9 [Authorised Economic Operators] of Chapter 5 [Customs and trade facilitation] of Title IV [Trade in goods] of Heading One of Part Two, ANNEX CUSTMS-1 [Authorised Economic Operators] and the Protocol on administrative cooperation and combating fraud in the field of Value Added Tax and on mutual assistance for the recovery of claims relating to taxes and duties shall not apply to the Bailiwick of Jersey or the Bailiwick of Guernsey.

5. Chapters 3 [SPS] and 4 [TBT] of Title IV [Trade in goods] of Heading One of Part Two and the Annexes to those Chapters shall also apply, with respect to the United Kingdom, to the territories referred to in Article FINPROV.1(2) [Territorial scope]. The authorities of the territories referred to in Article FINPROV.1(2) [Territorial scope] shall be responsible for the application and implementation of these Chapters, and the Annexes to these Chapters, in their respective territories and relevant references shall be read accordingly. However, requests and communications made under these Chapters, and the Annexes to these Chapters, shall be administered by the authorities of the United Kingdom.

6. Without prejudice to Article FINPROV.8 [Termination] and Article OTH.10 [Termination of Part Two] and unless agreed otherwise between the Parties, paragraphs 3 to 5 of this Article shall remain in force until the earlier of:

- (a) expiry of a period of three years following written notice of termination to the other Party; or
- (b) the date on which Article FISH.10 [Access to waters of the Bailiwick of Guernsey, the Bailiwick of Jersey and the Isle of Man], Article FISH.11 [Notification periods relating to the importation and direct landing of fisheries products] and any other provision of Heading Five [Fisheries] in so far as it relates to the arrangements provided for in those Articles cease to be in force.

7. For the purposes of point (a) of paragraph 6, notice of termination may be given in respect of one or more of the Bailiwick of Guernsey, the Bailiwick of Jersey or the Isle of Man and paragraphs 3 to 5 of this Article shall continue in force for those territories in respect of which a notice of termination has not been given.

---

<sup>76</sup> For greater certainty, for the European Union, the areas beyond each Party's territorial sea shall be understood as the respective areas of the Member States of the European Union.

8. For the purposes of point (b) of paragraph 6, if Article FISH.10 [Access to waters of the Bailiwick of Guernsey, the Bailiwick of Jersey and the Isle of Man], Article FISH.11 [Notification periods relating to the importation and direct landing of fisheries products] and any other provision of Heading Five [Fisheries] in so far as it relates to the arrangements provided for in those Articles cease to be in force in relation to one or more (but not all) of the Bailiwick of Guernsey, the Bailiwick of Jersey or the Isle of Man, paragraphs 3 to 5 of this Article shall continue to be in force for those territories in respect of which Article FISH.10 [Access to waters of the Bailiwick of Guernsey, the Bailiwick of Jersey and the Isle of Man], Article FISH.11 [Notification periods relating to the importation and direct landing of fisheries products] and any other provision of Heading Five [Fisheries] in so far as it relates to the arrangements provided for in those Articles remain in force.

#### Article OTH.10: Termination of Part Two

Without prejudice to Article FINPROV.8 [Termination], each Party may at any moment terminate this Part, by written notification through diplomatic channels. In that event, this Part shall cease to be in force on the first day of the ninth month following the date of notification. Heading Four [Social security coordination and visas for short-term travels] and the Protocol on Social Security Coordination shall not be terminated pursuant to this Article.

## **PART THREE: LAW ENFORCEMENT AND JUDICIAL COOPERATION IN CRIMINAL MATTERS**

### *TITLE I: GENERAL PROVISIONS*

#### Article LAW.GEN.1: Objective

1. The objective of this Part is to provide for law enforcement and judicial cooperation between the Member States and Union institutions, bodies, offices and agencies, on the one side, and the United Kingdom, on the other side, in relation to the prevention, investigation, detection and prosecution of criminal offences and the prevention of and fight against money laundering and financing of terrorism.

2. This Part only applies to law enforcement and judicial cooperation in criminal matters taking place exclusively between the United Kingdom, on the one side, and the Union and the Member States, on the other side. It does not apply to situations arising between the Member States, or between Member States and Union institutions, bodies, offices and agencies, nor does it apply to the activities of authorities with responsibilities for safeguarding national security when acting in that field.

#### Article LAW.GEN.2: Definitions

For the purposes of this Part, the following definitions apply:

- (a) “third country” means a country other than a State;
- (b) “special categories of personal data” means personal data revealing racial or ethnic origin, political opinions, religious or philosophical beliefs, or trade union membership, genetic data, biometric data processed for the purpose of uniquely identifying a natural person, data concerning health or data concerning a natural person's sex life or sexual orientation;
- (c) “genetic data” means all personal data relating to the genetic characteristics of an individual that have been inherited or acquired, which give unique information about the physiology or the health of that individual, resulting in particular from an analysis of a biological sample from the individual in question;
- (d) “biometric data” means personal data resulting from specific technical processing relating to the physical, physiological or behavioural characteristics of a natural person which allow or confirm the unique identification of that natural person, such as facial images or dactyloscopic data;
- (e) “processing” means any operation or set of operations which is performed on personal data or on sets of personal data, whether or not by automated means, such as collection, recording, organisation, structuring, storage, adaptation or alteration, retrieval, consultation, use, disclosure by transmission, dissemination or otherwise making available, alignment or combination, restriction, erasure or destruction;
- (f) “personal data breach” means a breach of security leading to the accidental or unlawful destruction, loss, alteration, unauthorised disclosure of, or access to, personal data transmitted, stored or otherwise processed;



- (g) “filing system” means any structured set of personal data which are accessible according to specific criteria, whether centralised, decentralised or dispersed on a functional or geographical basis;
- (h) “Specialised Committee on Law Enforcement and Judicial Cooperation” means the Committee by that name established by Article INST.2 [Committees].

#### Article LAW.GEN.3: Protection of human rights and fundamental freedoms

1. The cooperation provided for in this Part is based on the Parties’ and Member States’ long-standing respect for democracy, the rule of law and the protection of fundamental rights and freedoms of individuals, including as set out in the Universal Declaration of Human Rights and in the European Convention on Human Rights, and on the importance of giving effect to the rights and freedoms in that Convention domestically.

2. Nothing in this Part modifies the obligation to respect fundamental rights and legal principles as reflected, in particular, in the European Convention on Human Rights and, in the case of the Union and its Member States, in the Charter of Fundamental Rights of the European Union.

#### Article LAW.GEN.4: Protection of personal data

8. The cooperation provided for in this Part is based on the Parties’ long-standing commitment to ensuring a high level of protection of personal data.

9. To reflect that high level of protection, the Parties shall ensure that personal data processed under this Part is subject to effective safeguards in the Parties’ respective data protection regimes, including that:

- (a) personal data is processed lawfully and fairly in compliance with the principles of data minimisation, purpose limitation, accuracy and storage limitation;
- (b) processing of special categories of personal data is only permitted to the extent necessary and subject to appropriate safeguards adapted to the specific risks of the processing;
- (c) a level of security appropriate to the risk of the processing is ensured through relevant technical and organisational measures, in particular as regards the processing of special categories of personal data;
- (d) data subjects are granted enforceable rights of access, rectification and erasure, subject to possible restrictions provided for by law which constitute necessary and proportionate measures in a democratic society to protect important objectives of public interest;
- (e) in the event of a data breach creating a risk to the rights and freedoms of natural persons, the competent supervisory authority is notified without undue delay of the breach; where the breach is likely to result in a high risk to the rights and freedoms of natural persons, the data subjects are also notified, subject to possible restrictions provided for by law which constitute necessary and proportionate measures in a democratic society to protect important objectives of public interest;
- (f) onward transfers to a third country are allowed only subject to conditions and safeguards appropriate to the transfer ensuring that the level of protection is not undermined;

- (g) the supervision of compliance with data protection safeguards and the enforcement of data protection safeguards are ensured by independent authorities; and
- (h) data subjects are granted enforceable rights to effective administrative and judicial redress in the event that data protection safeguards have been violated.

10. The United Kingdom, on the one side, and the Union, also on behalf of any of its Member States, on the other side, shall notify the Specialised Committee on Law Enforcement and Judicial Cooperation of the supervisory authorities responsible for overseeing the implementation of, and ensuring compliance with, data protection rules applicable to cooperation under this Part. The supervisory authorities shall cooperate to ensure compliance with this Part.

11. The provisions on the protection of personal data set out in this Part apply to the processing of personal data wholly or partly by automated means, and to the processing other than by automated means of personal data which form part of a filing system or are intended to form part of a filing system.

12. This Article is without prejudice to the application of any specific provisions in this Part relating to the processing of personal data.

#### Article LAW.GEN.5: Scope of cooperation where a Member State no longer participates in analogous measures under Union law

1. This Article applies if a Member State ceases to participate in, or enjoy rights under, provisions of Union law relating to law enforcement and judicial cooperation in criminal matters analogous to any of the relevant provisions of this Part.

2. The United Kingdom may notify the Union in writing of its intention to cease to operate the relevant provisions of this Part in relation to that Member State.

3. A notification given under paragraph 2 takes effect on the date specified therein, which shall be no earlier than the date on which the Member State ceases to participate in, or to enjoy rights under, the provisions of Union law referred to in paragraph 1.

4. If the United Kingdom gives notification under this Article of its intention to cease to apply the relevant provisions of this Part, the Specialised Committee on Law Enforcement and Judicial Cooperation shall meet to decide what measures are needed to ensure that any cooperation initiated under this Part that is affected by the cessation is concluded in an appropriate manner. In any event, with regard to all personal data obtained through cooperation under the relevant provisions of this Part before they cease to be applied, the Parties shall ensure that the level of protection under which the personal data were transferred is maintained after the cessation takes effect.

5. The Union shall notify the United Kingdom in writing, through diplomatic channels, of the date on which the Member State is to resume its participation in, or the enjoyment of rights under, the provisions of Union law in question. The application of the relevant provisions of this Part shall be reinstated on that date or, if later, on the first day of the month following the day on which that notification has been given.

6. To facilitate the application of this Article, the Union shall inform the United Kingdom when a Member State ceases to participate in, or enjoy rights under, provisions of Union law relating to

law enforcement and judicial cooperation in criminal matters analogous to the relevant provisions of this Part.

## *TITLE II: EXCHANGES OF DNA, FINGERPRINTS AND VEHICLE REGISTRATION DATA*

### Article LAW.PRUM.5: Objective

The objective of this Title is to establish reciprocal cooperation between the competent law enforcement authorities of the United Kingdom, on the one side, and the Member States, on the other side, on the automated transfer of DNA profiles, dactyloscopic data and certain domestic vehicle registration data.

### Article LAW.PRUM.6: Definitions

For the purposes of this Title, the following definitions apply:

- (a) “competent law enforcement authority” means a domestic police, customs or other authority that is authorised by domestic law to detect, prevent and investigate offences or criminal activities and to exercise authority and take coercive measures in the context of such activities; agencies, bodies or other units dealing especially with national security issues are not competent law enforcement authorities for the purposes of this Title;
- (b) “search” and “comparison”, as referred to in Articles LAW.PRUM.8 [Automated searching of DNA profiles], LAW.PRUM.9 [Automated comparison of DNA profiles], LAW.PRUM.12 [Automated searching of dactyloscopic data], and LAW.PRUM.17 [Implementing measures] mean the procedures by which it is established whether there is a match between, respectively, DNA data or dactyloscopic data which have been communicated by one State and DNA data or dactyloscopic data stored in the databases of one, several, or all of the other States;
- (c) “automated searching”, as referred to in Article LAW.PRUM.15 [Automated searching of vehicle registration data], means an online access procedure for consulting the databases of one, several, or all of the other States;
- (d) “non-coding part of DNA” means chromosome regions not genetically expressed, i.e. not known to provide for any functional properties of an organism;
- (e) “DNA profile” means a letter or numeric code which represents a set of identification characteristics of the non-coding part of an analysed human DNA sample, i.e. the particular molecular structure at the various DNA locations (loci);
- (f) “DNA reference data” means DNA profile and reference number; DNA reference data shall only include DNA profiles established from the non-coding part of DNA and a reference number; DNA reference data shall not contain any data from which the data subject can be directly identified; DNA reference data which is not attributed to any natural person (unidentified DNA profiles) shall be recognisable as such;
- (g) “reference DNA profile” means the DNA profile of an identified person;
- (h) “unidentified DNA profile” means the DNA profile obtained from traces collected during the investigation of criminal offences and belonging to a person not yet identified;

- (i) “note” means a State's marking on a DNA profile in its domestic database indicating that there has already been a match for that DNA profile on another State's search or comparison;
- (j) “dactyloscopic data” means fingerprint images, images of fingerprint latents, palm prints, palm print latents and templates of such images (coded minutiae), when they are stored and dealt with in an automated database;
- (k) “dactyloscopic reference data” means dactyloscopic data and reference number; dactyloscopic reference data shall not contain any data from which the data subject can be directly identified; dactyloscopic reference data which is not attributed to any natural person (unidentified dactyloscopic data) shall be recognisable as such;
- (l) “vehicle registration data” means the data-set as specified in Chapter 3 of ANNEX LAW-1;
- (m) “individual case”, as referred to in Article LAW.PRUM.8(1) [Automated searching of DNA profiles], second sentence, Article LAW.PRUM.12(1) [Automated searching of dactyloscopic data], second sentence and Article LAW.PRUM.15(1) [Automated searching of vehicle registration data], means a single investigation or prosecution file; if such a file contains more than one DNA profile, or one piece of dactyloscopic data or vehicle registration data, they may be transmitted together as one request;
- (n) “laboratory activity” means any measure taken in a laboratory when locating and recovering traces on items, as well as developing, analysing and interpreting forensic evidence regarding DNA profiles and dactyloscopic data, with a view to providing expert opinions or exchanging forensic evidence;
- (o) “results of laboratory activities” means any analytical outputs and directly associated interpretation;
- (p) “forensic service provider” means any organisation, public or private, that carries out laboratory activities at the request of competent law enforcement or judicial authorities;
- (q) “domestic accreditation body” means the sole body in a State that performs accreditation with authority derived from the State.

#### Article LAW.PRUM.7: Establishment of domestic DNA analysis files

1. The States shall open and keep domestic DNA analysis files for the investigation of criminal offences.
2. For the purpose of implementing this Title, the States shall ensure the availability of DNA reference data from their domestic DNA analysis files as referred to in paragraph 1.
3. The States shall declare the domestic DNA analysis files to which Articles LAW.PRUM.7 [Establishment of domestic DNA analysis files] to LAW.PRUM.10 [Collection of cellular material and supply of DNA profiles] and Articles LAW.PRUM.13 [National contact points], LAW.PRUM.14 [Supply of further personal data and other information] and LAW.PRUM. 17 [Implementing measures] apply and the conditions for automated searching as referred to in Article LAW.PRUM.8(1) [Automated searching of DNA profiles].

#### Article LAW.PRUM.8: Automated searching of DNA profiles

1. For the investigation of criminal offences, States shall allow other States' national contact points as referred to in Article LAW.PRUM.13 [National contact points] access to the DNA reference data in their DNA analysis files, with the power to conduct automated searches by comparing DNA profiles. Searches may be conducted only in individual cases and in compliance with the requesting State's domestic law.
2. If an automated search shows that a DNA profile supplied matches DNA profiles entered in the requested State's searched file, the requested State shall send to the national contact point of the requesting State in an automated way the DNA reference data with which a match has been found. If no match can be found, this shall be notified automatically.

#### Article LAW.PRUM.9: Automated comparison of DNA profiles

1. For the investigation of criminal offences, the States, via their national contact points, shall compare the DNA profiles of their unidentified DNA profiles with all DNA profiles from other domestic DNA analysis files' reference data in accordance with mutually accepted practical arrangements between the States concerned. DNA profiles shall be supplied and compared in automated form. Unidentified DNA profiles shall be supplied for comparison only where provided for under the requesting State's domestic law.
2. If a State, as a result of the comparison referred to in paragraph 1, finds that any DNA profiles supplied by another State match any of those in its DNA analysis files, it shall supply that other State's national contact point with the DNA reference data with which a match has been found without delay.

#### Article LAW.PRUM.10: Collection of cellular material and supply of DNA profiles

Where, in ongoing investigations or criminal proceedings, there is no DNA profile available for a particular individual present within a requested State's territory, the requested State shall provide legal assistance by collecting and examining cellular material from that individual and by supplying the DNA profile obtained to the requesting State, if:

- (a) the requesting State specifies the purpose for which it is required;
- (b) the requesting State produces an investigation warrant or statement issued by the competent authority, as required under that State's domestic law, showing that the requirements for collecting and examining cellular material would be fulfilled if the individual concerned were present within the requesting State's territory; and
- (c) under the requested State's law, the requirements for collecting and examining cellular material and for supplying the DNA profile obtained are fulfilled.

#### Article LAW.PRUM.11: Dactyloscopic data

For the purpose of implementing this Title, the States shall ensure the availability of dactyloscopic reference data from the file for the domestic automated fingerprint identification systems established for the prevention and investigation of criminal offences.

#### Article LAW.PRUM.12: Automated searching of dactyloscopic data

1. For the prevention and investigation of criminal offences, States shall allow other States' national contact points, as referred to in Article LAW.PRUM.13 [National contact points], access to the reference data in the automated fingerprint identification systems which they have established for that purpose, with the power to conduct automated searches by comparing dactyloscopic data. Searches may be conducted only in individual cases and in compliance with the requesting State's domestic law.
2. The confirmation of a match of dactyloscopic data with reference data held by the requested State shall be carried out by the national contact point of the requesting State by means of the automated supply of the reference data required for a clear match.

#### Article LAW.PRUM.13: National contact points

1. For the purposes of the supply of data as referred to in Articles LAW.PRUM.8 [Automated searching of DNA profiles], LAW.PRUM.9 [Automated comparison of DNA profiles] and LAW.PRUM.12 [Automated searching of dactyloscopic data], the States shall designate national contact points.
2. In respect of the Member States, national contact points designated for an analogous exchange of data within the Union shall be considered as national contact points for the purpose of this Title.
3. The powers of the national contact points shall be governed by the applicable domestic law.

#### Article LAW.PRUM.14: Supply of further personal data and other information

If the procedure referred to in Articles LAW.PRUM.8 [Automated searching of DNA profiles], LAW.PRUM.9 [Automated comparison of DNA profiles] and LAW.PRUM.12 [Automated searching of dactyloscopic data] show a match between DNA profiles or dactyloscopic data, the supply of further available personal data and other information relating to the reference data shall be governed by the domestic law, including the legal assistance rules, of the requested State, without prejudice to Article LAW.PRUM.17(1) [Implementing measures].

#### Article LAW.PRUM.15: Automated searching of vehicle registration data

1. For the prevention and investigation of criminal offences and in dealing with other offences within the jurisdiction of the courts or a public prosecutor in the requesting State, as well as in maintaining public security, States shall allow other States' national contact points, as referred to in paragraph 2, access to the following domestic vehicle registration data, with the power to conduct automated searches in individual cases:
  - (a) data relating to owners or operators; and
  - (b) data relating to vehicles.
2. Searches may be conducted under paragraph 1 only with a full chassis number or a full registration number and in compliance with the requesting State's domestic law.

3. For the purposes of the supply of data as referred to in paragraph 1, the States shall designate a national contact point for incoming requests from other States. The powers of the national contact points shall be governed by the applicable domestic law.

Article LAW.PRUM.16: Accreditation of forensic service providers carrying out laboratory activities

1. The States shall ensure that their forensic service providers carrying out laboratory activities are accredited by a domestic accreditation body as complying with EN ISO/IEC 17025.

2. Each State shall ensure that the results of accredited forensic service providers carrying out laboratory activities in other States are recognised by its authorities responsible for the prevention, detection, and investigation of criminal offences as being equally reliable as the results of domestic forensic service providers carrying out laboratory activities accredited to EN ISO/IEC 17025.

3. The competent law enforcement authorities of the United Kingdom shall not carry out searches and automated comparison in accordance with Articles LAW.PRUM.8 [Automated searching of DNA profiles], LAW.PRUM.9 [Automated comparison of DNA profiles] and LAW.PRUM.12 [Automated searching of dactyloscopic data] before the United Kingdom has implemented and applied the measures referred to in paragraph 1 of this Article.

4. Paragraphs 1 and 2 do not affect domestic rules on the judicial assessment of evidence.

5. The United Kingdom shall communicate to the Specialised Committee on Law Enforcement and Judicial Cooperation the text of the main provisions adopted to implement and apply the provisions of this Article.

Article LAW.PRUM.17: Implementing measures

1. For the purposes of this Title, States shall make all categories of data available for searching and comparison to the competent law enforcement authorities of other States under conditions equal to those under which they are available for searching and comparison by domestic competent law enforcement authorities. States shall supply further available personal data and other information relating to the reference data as referred to in Article LAW.PRUM.14 [Supply of further personal data and other information] to the competent law enforcement authorities of other States for the purposes of this Title under conditions equal to those under which they would be supplied to domestic authorities.

2. For the purpose of implementing the procedures referred to in Articles LAW.PRUM.8 [Automated searching of DNA profiles], LAW.PRUM.9 [Automated comparison of DNA profiles], LAW.PRUM.12 [Automated searching of dactyloscopic data] and LAW.PRUM.15 [Automated searching of vehicle registration data], technical and procedural specifications are laid down in ANNEX LAW-1.

3. The declarations made by Member States in accordance with Council Decisions 2008/615/JHA<sup>77</sup> and 2008/616/JHA<sup>78</sup> shall also apply in their relations with the United Kingdom.

---

<sup>77</sup> Council Decision 2008/615/JHA of 23 June 2008 on the stepping up of cross-border cooperation, particularly in combating terrorism and cross-border crime (OJ EU L 210, 6.8.2008, p. 1).



#### Article LAW.PRUM.18: Ex ante evaluation

1. In order to verify whether the United Kingdom has fulfilled the conditions set out in Article LAW.PRUM.17 [Implementing measures] and ANNEX LAW-1, an evaluation visit and a pilot run, to the extent required by ANNEX LAW-1, shall be carried out in respect of, and under conditions and arrangements acceptable to, the United Kingdom. In any event, a pilot run shall be carried out in relation to the searching of data under Article LAW.PRUM.15 [Automated searching of vehicle registration data].
2. On the basis of an overall evaluation report on the evaluation visit and, where applicable, the pilot run, as referred to in paragraph 1, the Union shall determine the date or dates from which personal data may be supplied by Member States to the United Kingdom pursuant to this Title.
3. Pending the outcome of the evaluation referred to in paragraph 1, from the date of the entry into force of this Agreement, Member States may supply to the United Kingdom personal data as referred to in Articles LAW.PRUM.8 [Automated searching of DNA profiles], LAW.PRUM.9 [Automated comparison of DNA profiles], LAW.PRUM.12 [Automated searching of dactyloscopic data] and LAW.PRUM.14 [Supply of further personal data and other information] until the date or dates determined by the Union in accordance with paragraph 2 of this Article, but not longer than nine months after the entry into force of this Agreement. The Specialised Committee on Law Enforcement and Judicial Cooperation may extend this period once by a maximum of nine months.

#### Article LAW.PRUM.19: Suspension and disapplication

1. In the event that the Union considers it necessary to amend this Title because Union law relating to the subject matter governed by this Title is amended substantially, or is in the process of being amended substantially, it may notify the United Kingdom accordingly with a view to agreeing on a formal amendment of this Agreement in relation to this Title. Following such notification, the Parties shall engage in consultations.
2. Where within nine months of that notification the Parties have not reached an agreement amending this Title, the Union may decide to suspend the application of this Title or any provisions of this Title for a period of up to nine months. Before the end of that period, the Parties may agree on an extension of the suspension for an additional period of up to nine months. If by the end of the suspension period the Parties have not reached an agreement amending this Title, the suspended provisions shall cease to apply on the first day of the month following the expiry of the suspension period, unless the Union informs the United Kingdom that it no longer seeks any amendment to this Title. In that case, the suspended provisions of this Title shall be reinstated.
3. If any of the provisions of this Title are suspended under this Article, the Specialised Committee on Law Enforcement and Judicial Cooperation shall meet to decide what steps are needed to ensure that any cooperation initiated under this Title and affected by the suspension is concluded in an appropriate manner. In any event, with regard to all personal data obtained through cooperation under this Title before the provisions concerned by the suspension provisionally cease to apply, the Parties shall ensure that the level of protection under which the personal data were transferred is maintained after the suspension takes effect.

---

<sup>78</sup> Council Decision 2008/616/JHA of 23 June 2008 on the implementation of Decision 2008/615/JHA on the stepping up of cross-border cooperation, particularly in combating terrorism and cross-border crime (OJ EU L 210, 6.8.2008, p. 12).



### *TITLE III: TRANSFER AND PROCESSING OF PASSENGER NAME RECORD DATA*

#### Article LAW.PNR.18: Scope

1. This Title lays down rules under which passenger name record data may be transferred to, processed and used by the United Kingdom competent authority for flights between the Union and the United Kingdom, and establishes specific safeguards in that regard.
2. This Title applies to air carriers operating passenger flights between the Union and the United Kingdom.
3. This Title also applies to air carriers incorporated, or storing data, in the Union and operating passenger flights to or from the United Kingdom.
4. This Title also provides for police and judicial cooperation in criminal matters between the United Kingdom and the Union in respect of PNR data.

#### Article LAW.PNR.19: Definitions

For the purposes of this Title, the following definitions apply:

- (a) “air carrier” means an air transport undertaking with a valid operating licence or equivalent permitting it to carry out carriage of passengers by air between the United Kingdom and the Union;
- (b) “passenger name record” (“PNR”) means a record of each passenger's travel requirements which contains information necessary to enable reservations to be processed and controlled by the booking and participating air carriers for each journey booked by or on behalf of any person, whether it is contained in reservation systems, departure control systems used to check passengers into flights, or equivalent systems providing the same functionalities; specifically, as used in this Title, PNR data consists of the elements set out in ANNEX LAW-2;
- (c) “United Kingdom competent authority” means the United Kingdom authority responsible for receiving and processing PNR data under this Agreement; if the United Kingdom has more than one competent authority it shall provide a passenger data single window facility that allows air carriers to transfer PNR data to a single data transmission entry point and shall designate a single point of contact for the purpose of receiving and making requests under Article LAW.PNR.22 [Police and judicial Cooperation];
- (d) “Passenger Information Units” (“PIUs”) means the Units established or designated by Member States that are responsible for receiving and processing PNR data;
- (e) “terrorism” means any offence listed in ANNEX LAW-7;
- (f) “serious crime” means any offence punishable by a custodial sentence or detention order for a maximum period of at least three years under the domestic law of the United Kingdom.

#### Article LAW.PNR.20: Purposes of the use of PNR data

1. The United Kingdom shall ensure that PNR data received pursuant to this Title is processed strictly for the purposes of preventing, detecting, investigating or prosecuting terrorism or serious

crime and for the purposes of overseeing the processing of PNR data within the terms set out in this Agreement.

2. In exceptional cases, the United Kingdom competent authority may process PNR data where necessary to protect the vital interests of any natural person, such as:

- (a) a risk of death or serious injury; or
- (b) a significant public health risk, in particular as identified under internationally recognised standards.

3. The United Kingdom competent authority may also process PNR data on a case-by-case basis where the disclosure of relevant PNR data is compelled by a United Kingdom court or administrative tribunal in a proceeding directly related to any of the purposes referred to in paragraph 1.

#### Article LAW.PNR.21: Ensuring PNR data is provided

1. The Union shall ensure that air carriers are not prevented from transferring PNR data to the United Kingdom competent authority pursuant to this Title.

2. The Union shall ensure that air carriers may transfer PNR data to the United Kingdom competent authority through authorised agents, who act on behalf of and under the responsibility of an air carrier, pursuant to this Title.

3. The United Kingdom shall not require an air carrier to provide elements of PNR data which are not already collected or held by the air carrier for reservation purposes.

4. The United Kingdom shall delete any data transferred to it by an air carrier pursuant to this Title upon receipt of that data, if that data element is not listed in ANNEX LAW-2.

#### Article LAW.PNR.22: Police and judicial cooperation

1. The United Kingdom competent authority shall share with Europol or Eurojust, within the scope of their respective mandates, or with the PIUs of the Member States all relevant and appropriate analytical information containing PNR data as soon as possible in specific cases where necessary to prevent, detect, investigate, or prosecute terrorism or serious crime.

2. At the request of Europol or Eurojust, within the scope of their respective mandates, or of the PIU of a Member State, the United Kingdom competent authority shall share PNR data, the results of processing those data, or analytical information containing PNR data, in specific cases where necessary to prevent, detect, investigate, or prosecute terrorism or serious crime.

3. The PIUs of the Member States shall share with the United Kingdom competent authority all relevant and appropriate analytical information containing PNR data as soon as possible in specific cases where necessary to prevent, detect, investigate, or prosecute terrorism or serious crime.

4. At the request of the United Kingdom competent authority, the PIUs of the Member States shall share PNR data, the results of processing those data, or analytical information containing PNR data, in specific cases where necessary to prevent, detect, investigate, or prosecute terrorism or serious crime.

5. The Parties shall ensure that the information referred to in paragraphs 1 to 4 is shared in accordance with agreements and arrangements on law enforcement or information sharing between the United Kingdom and Europol, Eurojust, or the relevant Member State. In particular, the exchange of information with Europol under this Article shall take place through the secure communication line established for the exchange of information through Europol.

6. The United Kingdom competent authority and the PIUs of the Member States shall ensure that only the minimum amount of PNR data necessary is shared under paragraphs 1 to 4.

#### Article LAW.PNR.23: Non-discrimination

The United Kingdom shall ensure that the safeguards applicable to the processing of PNR data apply to all natural persons on an equal basis without unlawful discrimination.

#### Article LAW.PNR.24: Use of special categories of personal data

Any processing of special categories of personal data shall be prohibited under this Title. To the extent that any PNR data which is transferred to the United Kingdom competent authority includes special categories of personal data, the United Kingdom competent authority shall delete such data.

#### Article LAW.PNR.25: Data security and integrity

1. The United Kingdom shall implement regulatory, procedural or technical measures to protect PNR data against accidental, unlawful or unauthorised access, processing or loss.

2. The United Kingdom shall ensure compliance verification and the protection, security, confidentiality, and integrity of the data. In that regard, the United Kingdom shall:

- (a) apply encryption, authorisation, and documentation procedures to the PNR data;
- (b) limit access to PNR data to authorised officials;
- (c) hold PNR data in a secure physical environment that is protected with access controls; and
- (d) establish a mechanism that ensures that PNR data queries are conducted in a manner consistent with Article LAW.PNR.20 [Purposes of the use of PNR data].

3. If a natural person's PNR data is accessed or disclosed without authorisation, the United Kingdom shall take measures to notify that natural person, to mitigate the risk of harm, and to take remedial action.

4. The United Kingdom competent authority shall promptly inform the Specialised Committee on Law Enforcement and Judicial Cooperation of any significant incident of accidental, unlawful or unauthorised access, processing or loss of PNR data.

5. The United Kingdom shall ensure that any breach of data security, in particular any breach leading to accidental or unlawful destruction or accidental loss, alteration, unauthorised disclosure or access, or any unlawful forms of processing, are subject to effective and dissuasive corrective measures which may include sanctions.

#### Article LAW.PNR.26: Transparency and notification of passengers

1. The United Kingdom competent authority shall make the following available on its website:

- (a) a list of the legislation authorising the collection of PNR data;
- (b) the purposes for the collection of PNR data;
- (c) the manner of protecting PNR data;
- (d) the manner and extent to which PNR data may be disclosed;
- (e) information regarding the rights of access, correction, notation and redress; and
- (f) contact information for inquiries.

2. The Parties shall work with interested third parties, such as the aviation and air travel industry, to promote transparency at the time of booking regarding the purpose of the collection, processing and use of PNR data, and regarding how to request access, correction and redress. Air carriers shall provide passengers with clear and meaningful information in relation to the transfer of PNR data under this Title, including the details of the recipient authority, the purpose of the transfer and the right to request from the recipient authority, access to and correction of the personal data of the passenger that has been transferred.

3. Where PNR data retained in accordance with Article LAW.PNR.28 [Retention of PNR data] has been used subject to the conditions set out in Article LAW.PNR.29 [Conditions for the use of PNR data] or has been disclosed in accordance with Article LAW.PNR.31 [Disclosure within the United Kingdom] or Article LAW.PNR.32 [Disclosure outside the United Kingdom], the United Kingdom shall notify the passengers concerned in writing, individually and within a reasonable time once such notification is no longer liable to jeopardise the investigations by the public authorities concerned to the extent that the relevant contact information of the passengers is available or can be retrieved, taking into account reasonable efforts. The notification shall include information on how the natural person concerned can seek administrative or judicial redress.

#### Article LAW.PNR.27: Automated processing of PNR data

1. The United Kingdom competent authority shall ensure that any automated processing of PNR data is based on non-discriminatory, specific and reliable pre-established models and criteria to enable it to:

- (a) arrive at results targeting natural persons who might be under a reasonable suspicion of involvement or participation in terrorism or serious crime; or
- (b) in exceptional circumstances, protect the vital interests of any natural person as set out in Article LAW.PNR.20(2) [Purposes of the use of PNR data].

2. The United Kingdom competent authority shall ensure that the databases against which PNR data are compared are reliable, up to date and limited to those databases it uses in relation to the purposes set out in Article LAW.PNR.20 [Purposes of the use of PNR data].

3. The United Kingdom shall not take any decision adversely affecting a natural person in a significant manner solely on the basis of automated processing of PNR data.

#### Article LAW.PNR.28: Retention of PNR data

1. The United Kingdom shall not retain PNR data for more than five years from the date that it receives the PNR data.
2. No later than six months after the transfer of the PNR data referred to in paragraph 1, all PNR data shall be depersonalised by masking out the following data elements which could serve to identify directly the passenger to whom the PNR data relate or any other natural person:
  - (a) names, including the names of other passengers on the PNR and number of passengers on the PNR travelling together;
  - (b) addresses, telephone numbers and electronic contact information of the passenger, the persons who made the flight reservation for the passenger, persons through whom the air passenger may be contacted and persons who are to be informed in the event of an emergency;
  - (c) all available payment and billing information, to the extent that it contains any information which could serve to identify a natural person;
  - (d) frequent flyer information;
  - (e) other supplementary information (OSI), special service information (SSI) and special service request (SSR) information, to the extent that they contain any information which could serve to identify a natural person; and
  - (f) any advance passenger information (API) data that have been collected.
3. The United Kingdom competent authority may unmask PNR data only if it is necessary to carry out investigations for the purposes set out in Article LAW.PNR.20 [Purposes of the use of PNR data]. Such unmasked PNR data shall be accessible only to a limited number of specifically authorised officials.
4. Notwithstanding paragraph 1, the United Kingdom shall delete the PNR data of passengers after their departure from the country unless a risk assessment indicates the need to retain such PNR data. In order to establish that need, the United Kingdom shall identify objective evidence from which it may be inferred that certain passengers present the existence of a risk in terms of the fight against terrorism and serious crime.
5. For the purposes of paragraph 4, unless information is available on the exact date of departure, the date of departure should be considered as the last day of the period of maximum lawful stay in the United Kingdom of the passenger concerned.
6. The use of the data retained under this Article is subject to the conditions laid down in Article LAW.PNR.29 [Conditions for the use of PNR].
7. An independent administrative body in the United Kingdom shall assess on a yearly basis the approach applied by the United Kingdom competent authority as regards the need to retain PNR data pursuant to paragraph 4.

8. Notwithstanding paragraphs 1, 2 and 4, the United Kingdom may retain PNR data required for any specific action, review, investigation, enforcement action, judicial proceeding, prosecution, or enforcement of penalties, until concluded.

9. The United Kingdom shall delete the PNR data at the end of the PNR data retention period.

10. Paragraph 11 applies due to the special circumstances that prevent the United Kingdom from making the technical adjustments necessary to transform the PNR processing systems which the United Kingdom operated whilst Union law applied to it into systems which would enable PNR data to be deleted in accordance with paragraph 4.

11. The United Kingdom may derogate from paragraph 4 on a temporary basis for an interim period, the duration of which is provided for in paragraph 13, pending the implementation by the United Kingdom of technical adjustments as soon as possible. During the interim period, the United Kingdom competent authority shall prevent the use of the PNR data that is to be deleted in accordance with paragraph 4 by applying the following additional safeguards to that PNR data:

- (a) the PNR data shall be accessible only to a limited number of authorised officials and only where necessary to determine whether the PNR data should be deleted in accordance with paragraph 4;
- (b) the request to use the PNR data shall be refused in cases where the data is to be deleted in accordance with paragraph 4, and no further access shall be granted to that data where the documentation referred to in point (d) of this paragraph indicates that an earlier request for use has been refused;
- (c) deletion of the PNR data shall be ensured as soon as possible using best efforts, taking into account the special circumstances referred to in paragraph 10; and
- (d) the following shall be documented in accordance with Article LAW.PNR.30 [Logging and documenting of PNR data processing], and such documentation shall be made available to the independent administrative body referred to in paragraph 7 of this Article:
  - (i) any requests to use the PNR data;
  - (ii) the date and time of the access to the PNR data for the purpose of assessing whether deletion of the PNR data was required;
  - (iii) that the request to use the PNR data was refused on the basis that the PNR data should have been deleted under paragraph 4, including the date and time of the refusal; and
  - (iv) the date and time of the deletion of the PNR data in accordance with point (c) of this paragraph.

12. The United Kingdom shall provide to the Specialised Committee on Law Enforcement and Judicial Cooperation, nine months after the entry into force of this Agreement and again a year later if the interim period is extended for a further year:

- (a) a report from the independent administrative body referred to in paragraph 7 of this Article, which shall include the opinion of the United Kingdom supervisory authority referred to in

Article LAW.GEN.4(3) [Protection of personal data] as to whether the safeguards provided for in paragraph 11 of this Article have been effectively applied; and

- (b) the assessment of the United Kingdom of whether the special circumstances referred to in paragraph 10 of this Article persist, together with a description of the efforts made to transform the PNR processing systems of the United Kingdom into systems which would enable PNR data to be deleted in accordance with paragraph 4 of this Article.

13. The Specialised Committee on Law Enforcement and Judicial Cooperation shall meet within one year of the entry into force of this Agreement to consider the report and assessment provided under paragraph 12. Where the special circumstances referred to in paragraph 10 persist, the Partnership Council shall extend the interim period referred to in paragraph 11 for one year. The Partnership Council shall extend the interim period for one further final year, under the same conditions and following the same procedure as for the first extension where, in addition, substantial progress has been made, although it has not yet been possible to transform the United Kingdom PNR processing systems into systems which would enable PNR data to be deleted in accordance with paragraph 4.

14. If the United Kingdom considers that a refusal by the Partnership Council to grant either of those extensions was not justified, it may suspend this Title with one month's notice.

15. On the third anniversary of the date of entry into force of this Agreement, paragraphs 10 to 14 shall cease to apply.

#### Article LAW.PNR.29: Conditions for the use of PNR data

1. The United Kingdom competent authority may use PNR data retained in accordance with Article LAW.PNR.28 [Retention of PNR data] for purposes other than security and border control checks, including any disclosure under Article LAW.PNR.31 [Disclosure within the United Kingdom] and Article LAW.PNR.32 [Disclosure outside the United Kingdom], only where new circumstances based on objective grounds indicate that the PNR data of one or more passengers might make an effective contribution to the attainment of the purposes set out in Article LAW.PNR.20 [Purposes of the use of PNR data].

2. Use of PNR data by the United Kingdom competent authority in accordance with paragraph 1 shall be subject to prior review by a court or by an independent administrative body in the United Kingdom based on a reasoned request by the United Kingdom competent authority submitted within the domestic legal framework of procedures for the prevention, detection or prosecution of crime, except:

- (a) in cases of validly established urgency; or
- (b) for the purpose of verifying the reliability and currency of the pre-established models and criteria on which the automated processing of PNR data is based, or of defining new models and criteria for such processing.

#### Article LAW.PNR.30: Logging and documenting of PNR data processing

The United Kingdom competent authority shall log and document all processing of PNR data. It shall only use such logging or documentation to:

- (a) self-monitor and to verify the lawfulness of data processing;



- (b) ensure proper data integrity;
- (c) ensure the security of data processing; and
- (d) ensure oversight.

#### Article LAW.PNR.31: Disclosure within the United Kingdom

1. The United Kingdom competent authority shall not disclose PNR data to other public authorities in the United Kingdom unless the following conditions are met:

- (a) the PNR data is disclosed to public authorities whose functions are directly related to the purposes set out in Article LAW.PNR.20 [Purposes of the use of PNR data];
- (b) the PNR data is disclosed only on a case-by-case basis;
- (c) the disclosure is necessary, in the particular circumstances, for the purposes set out in Article LAW.PNR.20 [Purposes of the use of PNR data];
- (d) only the minimum amount of PNR data necessary is disclosed;
- (e) the receiving public authority affords protection equivalent to the safeguards described in this Title; and
- (f) the receiving public authority does not disclose the PNR data to another entity unless the disclosure is authorised by the United Kingdom competent authority in accordance with the conditions laid down in this paragraph.

2. When transferring analytical information containing PNR data obtained under this Title, the safeguards set out in this Article shall apply.

#### Article LAW.PNR.32: Disclosure outside the United Kingdom

1. The United Kingdom shall ensure that the United Kingdom competent authority does not disclose PNR data to public authorities in third countries unless all the following conditions are met:

- (a) the PNR data is disclosed to public authorities whose functions are directly related to the purposes set out in Article LAW.PNR.20 [Purposes of the use of PNR data];
- (b) the PNR data is disclosed only on a case-by-case basis;
- (c) the PNR data is disclosed only if necessary for the purposes set out in Article LAW.PNR.20 [Purposes of the use of PNR data];
- (d) only the minimum amount of PNR data necessary is disclosed; and
- (e) the third country to which the PNR data is disclosed has either concluded an agreement with the Union that provides for the protection of personal data comparable to this Agreement or is subject to a decision of the European Commission pursuant to Union law that finds that the third country ensures an adequate level of data protection within the meaning of Union law.



2. As an exception to point (e) of paragraph 1, the United Kingdom competent authority may transfer PNR data to a third country if:

- (a) the head of that authority, or a senior official specifically mandated by the head, considers that the disclosure is necessary for the prevention and investigation of a serious and imminent threat to public security or to protect the vital interests of any natural person; and
- (b) the third country provides a written assurance, pursuant to an arrangement, agreement or otherwise, that the information shall be protected in line with the safeguards applicable under United Kingdom law to the processing of PNR data received from the Union, including those set out in this Title.

3. A transfer in accordance with paragraph 2 of this Article shall be documented. Such documentation shall be made available to the supervisory authority referred to in Article LAW.GEN.4(3) [Protection of personal data] on request, including the date and time of the transfer, information about the receiving authority, the justification for the transfer and the PNR data transferred.

4. If, in accordance with paragraph 1 or 2, the United Kingdom competent authority discloses PNR data collected under this Title that originates in a Member State, the United Kingdom competent authority shall notify the authorities of that Member State of the disclosure at the earliest appropriate opportunity. The United Kingdom shall make that notification in accordance with agreements or arrangements on law enforcement or information sharing between the United Kingdom and that Member State.

5. When transferring analytical information containing PNR data obtained under this Title, the safeguards set out in this Article shall apply.

#### Article LAW.PNR.33: Method of transfer

Air carriers shall transfer PNR data to the United Kingdom competent authority exclusively on the basis of the 'push method', a method by which air carriers transfer PNR data into the database of the United Kingdom competent authority, and in accordance with the following procedures to be observed by air carriers, by which they:

- (a) transfer PNR data by electronic means in compliance with the technical requirements of the United Kingdom competent authority or, in the case of a technical failure, by any other appropriate means ensuring an appropriate level of data security;
- (b) transfer PNR data using a mutually accepted messaging format; and
- (c) transfer PNR data in a secure manner using common protocols as required by the United Kingdom competent authority.

#### Article LAW.PNR.34: Frequency of transfer

1. The United Kingdom competent authority shall require air carriers to transfer the PNR data:

- (a) initially from no earlier than 96 hours before the scheduled flight service departure time; and
- (b) a maximum number of five times as specified by the United Kingdom competent authority.

2. The United Kingdom competent authority shall permit air carriers to limit the transfer referred to in point (b) of paragraph 1 to updates of the PNR data transferred as referred to in point (a) of that paragraph.

3. The United Kingdom competent authority shall inform air carriers of the specified times for the transfers.

4. In specific cases where there is an indication that additional access to PNR data is necessary to respond to a specific threat related to the purposes set out in Article LAW.PNR.20 [Purposes of the use of PNR data], the United Kingdom competent authority may require an air carrier to provide PNR data prior to, between or after the scheduled transfers. In exercising that discretion, the United Kingdom competent authority shall act judiciously and proportionately, and shall use the method of transfer described in Article LAW.PNR.33 [Method of transfer].

#### Article LAW.PNR.35: Cooperation

The United Kingdom competent authority and the PIUs of the Member States shall cooperate to pursue the coherence of their PNR data processing regimes in a manner that further enhances the security of individuals in the United Kingdom, the Union and elsewhere.

#### Article LAW.PNR.36: Non-derogation

This Title shall not be construed as derogating from any obligation between the United Kingdom and Member States or third countries to make or respond to a request under a mutual assistance instrument.

#### Article LAW.PNR.37: Consultation and review

1. The Parties shall advise each other of any measure that is to be enacted that may affect this Title.

2. When carrying out joint reviews of this Title as referred to in Article LAW.OTHER.135(1) [Review and evaluation], the Parties shall pay particular attention to the necessity and proportionality of processing and retaining PNR data for each of the purposes set out in Article LAW.PNR.20 [Purposes of the use of PNR data]. The joint reviews shall also include an examination of how the United Kingdom competent authority has ensured that the pre-established models, criteria and databases referred to in Article LAW.PNR.27 [Automated processing of PNR data] are reliable, relevant and current, taking into account statistical data.

#### Article LAW.PNR 38: Suspension of cooperation under this Title

1. In the event that either Party considers that the continued operation of this Title is no longer appropriate, it may notify the other Party accordingly of its intention to suspend the application of this Title. Following such notification, the Parties shall engage in consultations.

2. Where within 6 months of that notification the Parties have not reached a resolution, either Party may decide to suspend the application of this Title for a period of up to 6 months. Before the end of that period, the Parties may agree an extension of the suspension for an additional period of up to 6 months. If by the end of the suspension period the Parties have not reached a resolution with respect to this Title, this Title shall cease to apply on the first day of the month following the expiry of the suspension period, unless the notifying Party informs the other Party that it wishes to withdraw the notification. In that case, the provisions of this Title shall be reinstated.

3. If this Title is suspended under this Article, the Specialised Committee on Law Enforcement and Judicial Cooperation shall meet to decide what steps are needed to ensure that any cooperation initiated under this Title that is affected by the suspension is concluded in an appropriate manner. In any event, with regard to all personal data obtained through cooperation under this Title before the provisions concerned by the suspension provisionally cease to apply, the Parties shall ensure that the level of protection under which the personal data were transferred is maintained after the suspension takes effect.

#### *TITLE IV: COOPERATION ON OPERATIONAL INFORMATION*

##### Article LAW.OPCO.1: Cooperation on Operational Information

1. The objective of this Title is for the Parties to ensure that the competent authorities of the United Kingdom and of the Member States are able to, subject to the conditions of their domestic law and within the scope of their powers, and to the extent that this is not provided for in other Titles of this Part, assist each other through the provision of relevant information for the purposes of:

- (a) the prevention, investigation, detection or prosecution of criminal offences;
- (b) the execution of criminal penalties;
- (c) safeguarding against, and the prevention of, threats to public safety; and
- (d) the prevention and combating of money laundering and the financing of terrorism.

2. For the purposes of this Title, a “competent authority” means a domestic police, customs or other authority that is competent under domestic law to undertake activities for the purposes set out in paragraph 1.

3. Information, including information on wanted and missing persons as well as objects, may be requested by a competent authority of the United Kingdom or of a Member State, or provided spontaneously to a competent authority of the United Kingdom or of a Member State. Information may be provided in response to a request or spontaneously, subject to the conditions of the domestic law which applies to the providing competent authority and within the scope of its powers.

4. Information may be requested and provided to the extent that the conditions of the domestic law which applies to the requesting or providing competent authority do not stipulate that the request or provision of information has to be made or channelled via judicial authorities.

5. In urgent cases, the providing competent authority shall respond to a request, or provide information spontaneously, as soon as possible.

6. A competent authority of the requesting State may, in accordance with relevant domestic law, at the time of making the request or at a later point in time, seek consent from the providing State for the information to be used for evidential purposes in proceedings before a judicial authority. The providing State may, subject to the conditions set out in Title VIII [Mutual Legal Assistance] and the conditions of the domestic law which applies to it, consent to the information being used for evidential purposes before a judicial authority in the requesting State. Equally, where information is provided spontaneously, the providing State may consent to the information being used for evidential purposes in proceedings before a judicial authority in the receiving State. Where consent is not given under this paragraph, the information received shall not be used for evidential purposes in proceedings before a judicial authority.

7. The providing competent authority may, under relevant domestic law, impose conditions on the use of the information provided.

8. A competent authority may provide under this Title any type of information which it holds, subject to the conditions of the domestic law which applies to it and within the scope of its powers.

This may include information from other sources, only if onward transfer of that information is permitted in the framework under which it was obtained by the providing competent authority.

9. Information may be provided under this Title via any appropriate communication channel, including the secure communication line for the purpose of provision of information through Europol.

10. This Article shall not affect the operation or conclusion of bilateral agreements between the United Kingdom and Member States, provided that the Member States act in compliance with Union law. It shall also not affect any other powers which are available to the competent authorities of the United Kingdom or of the Member States under applicable domestic or international law to provide assistance through the sharing of information for the purposes set out in paragraph 1.

#### *TITLE V: COOPERATION WITH EUROPOL*

##### Article LAW.EUROPOL.46: Objective

The objective of this Title is to establish cooperative relations between Europol and the competent authorities of the United Kingdom in order to support and strengthen the action by the Member States and the United Kingdom, as well as their mutual cooperation in preventing and combating serious crime, terrorism and forms of crime which affect a common interest covered by a Union policy, as referred to in Article LAW.EUROPOL.48 [Forms of crime].

##### Article LAW.EUROPOL.47: Definitions

For the purposes of this Title, the following definitions apply:

- (a) “Europol” means the European Union Agency for Law Enforcement Cooperation, set up under Regulation (EU) 2016/794<sup>79</sup> (the “Europol Regulation”);
- (b) “competent authority” means, for the Union, Europol and, for the United Kingdom, a domestic law enforcement authority responsible under domestic law for preventing and combating criminal offences;

##### Article LAW.EUROPOL.48: Forms of crime

1. The cooperation established under this Title relates to the forms of crime within Europol’s competence, as listed in ANNEX LAW-3, including related criminal offences.

2. Related criminal offences are criminal offences committed in order to procure the means of committing the forms of crime referred to in paragraph 1, criminal offences committed in order to facilitate or carry out such crimes, and criminal offences committed to ensure impunity for such crimes.

3. Where the list of forms of crime for which Europol is competent under Union law is changed, the Specialised Committee on Law Enforcement and Judicial Cooperation may, upon a proposal from

---

<sup>79</sup> Regulation (EU) 2016/794 of the European Parliament and of the Council of 11 May 2016 on the European Union Agency for Law Enforcement Cooperation (Europol) and replacing and repealing Council Decisions 2009/371/JHA, 2009/934/JHA, 2009/935/JHA, 2009/936/JHA and 2009/968/JHA (OJ EU L 135, 24.5.2016, p. 53).

the Union, amend ANNEX LAW-3 accordingly from the date when the change to Europol's competence enters into effect.

#### Article LAW.EUROPOL.49: Scope of cooperation

The cooperation may, in addition to the exchange of personal data under the conditions laid down in this Title and in accordance with the tasks of Europol as outlined in the Europol Regulation, in particular include:

- (a) the exchange of information such as specialist knowledge;
- (b) general situation reports;
- (c) results of strategic analysis;
- (d) information on criminal investigation procedures;
- (e) information on crime prevention methods;
- (f) participation in training activities; and
- (g) the provision of advice and support in individual criminal investigations as well as operational cooperation.

#### Article LAW.EUROPOL.50: National contact point and liaison officers

1. The United Kingdom shall designate a national contact point to act as the central point of contact between Europol and the competent authorities of the United Kingdom.
2. The exchange of information between Europol and the competent authorities of the United Kingdom shall take place between Europol and the national contact point referred to in paragraph 1. This does not preclude, however, direct exchanges of information between Europol and the competent authorities of the United Kingdom, if considered appropriate by both Europol and the relevant competent authorities.
3. The national contact point shall also be the central point of contact in respect of review, correction and deletion of personal data.
4. To facilitate the cooperation established under this Title, the United Kingdom shall second one or more liaison officers to Europol. Europol may second one or more liaison officers to the United Kingdom.
5. The United Kingdom shall ensure that its liaison officers have speedy and, where technically possible, direct access to the relevant domestic databases of the United Kingdom that are necessary for them to fulfil their tasks.
6. The number of liaison officers, the details of their tasks, their rights and obligations and the costs involved shall be governed by working arrangements concluded between Europol and the competent authorities of the United Kingdom as referred to in Article LAW.EUROPOL.59 [Working and administrative arrangements].

7. Liaison officers from the United Kingdom and representatives of the competent authorities of the United Kingdom may be invited to operational meetings. Member State liaison officers and third-country liaison officers, representatives of competent authorities from the Member States and third countries, Europol staff and other stakeholders may attend meetings organised by the liaison officers or the competent authorities of the United Kingdom.

#### Article LAW.EUROPOL.51: Exchanges of information

1. Exchanges of information between the competent authorities shall comply with the objective and provisions of this Title. Personal data shall be processed only for the specific purposes referred to in paragraph 2.

2. The competent authorities shall clearly indicate, at the latest at the moment of transferring personal data, the specific purpose or purposes for which the personal data are being transferred. For transfers to Europol, the purpose or purposes of such transfer shall be specified in line with the specific purposes of processing set out in the Europol Regulation. If the transferring competent authority has not done so, the receiving competent authority, in agreement with the transferring authority, shall process the personal data in order to determine their relevance as well as the purpose or purposes for which it is to be further processed. The competent authorities may process personal data for a purpose other than the purpose for which they have been provided only if authorised to do so by the transferring competent authority.

3. The competent authorities receiving the personal data shall give an undertaking stating that such data will be processed only for the purpose for which they were transferred. The personal data shall be deleted as soon as they are no longer necessary for the purpose for which they were transferred.

4. Europol and the competent authorities of the United Kingdom shall determine without undue delay, and in any event no later than six months after receipt of the personal data, if and to what extent those personal data are necessary for the purpose for which they were transferred and inform the transferring authority accordingly.

#### Article LAW.EUROPOL.52: Restrictions on access to and further use of transferred personal data

1. The transferring competent authority may indicate, at the moment of transferring personal data, any restriction on access thereto or the use to be made thereof, in general or specific terms, including as regards its onward transfer, erasure or destruction after a certain period of time, or its further processing. Where the need for such restrictions becomes apparent after the personal data have been transferred, the transferring competent authority shall inform the receiving competent authority accordingly.

2. The receiving competent authority shall comply with any restriction on access or further use of the personal data indicated by the transferring competent authority as described in paragraph 1.

3. Each Party shall ensure that information transferred under this Title was collected, stored and transferred in accordance with its respective legal framework. Each Party shall ensure, as far as possible, that such information has not been obtained in violation of human rights. Nor shall such information be transferred if, to the extent reasonably foreseeable, it could be used to request, hand down or execute a death penalty or any form of cruel or inhuman treatment.

#### Article LAW.EUROPOL.53: Different categories of data subjects

1. The transfer of personal data in respect of victims of a criminal offence, witnesses or other persons who can provide information concerning criminal offences, or in respect of persons under the age of 18, shall be prohibited unless such transfer is strictly necessary and proportionate in individual cases for preventing or combating a criminal offence.
2. The United Kingdom and Europol shall each ensure that the processing of personal data under paragraph 1 is subject to additional safeguards, including restrictions on access, additional security measures and limitations on onward transfers.

#### Article LAW.EUROPOL.54: Facilitation of flow of personal data between the United Kingdom and Europol

In the interest of mutual operational benefits, the Parties shall endeavour to cooperate in the future with a view to ensuring that data exchanges between Europol and the competent authorities of the United Kingdom can take place as quickly as possible, and to consider the incorporation of any new processes and technical developments which might assist with that objective, while taking account of the fact that the United Kingdom is not a Member State.

#### Article LAW.EUROPOL.55: Assessment of reliability of the source and accuracy of information

1. The competent authorities shall indicate as far as possible, at the latest at the moment of transferring the information, the reliability of the source of the information on the basis of the following criteria:
  - (a) where there is no doubt as to the authenticity, trustworthiness and competence of the source, or if the information is provided by a source which has proved to be reliable in all instances;
  - (b) where the information is provided by a source which has in most instances proved to be reliable;
  - (c) where the information is provided by a source which has in most instances proved to be unreliable;
  - (d) where the reliability of the source cannot be assessed.
2. The competent authorities shall indicate as far as possible, at the latest at the moment of transferring the information, the accuracy of the information on the basis of the following criteria:
  - (a) information the accuracy of which is not in doubt;
  - (b) information known personally to the source but not known personally to the official passing it on;
  - (c) information not known personally to the source but corroborated by other information already recorded;
  - (d) information not known personally to the source and which cannot be corroborated.



3. Where the receiving competent authority, on the basis of information already in its possession, comes to the conclusion that the assessment of information or of its source supplied by the transferring competent authority in accordance with paragraphs 1 and 2 needs correction, it shall inform that competent authority and shall attempt to agree on an amendment to the assessment. The receiving competent authority shall not change the assessment of information received or of its source without such agreement.

4. If a competent authority receives information without an assessment, it shall attempt as far as possible and where possible in agreement with the transferring competent authority to assess the reliability of the source or the accuracy of the information on the basis of information already in its possession.

5. If no reliable assessment can be made, the information shall be evaluated as provided for in point (d) of paragraph 1 and point (d) of paragraph 2.

#### Article LAW.EUROPOL.56: Security of the information exchange

1. The technical and organisational measures put in place to ensure the security of the information exchange under this Title shall be laid down in administrative arrangements between Europol and the competent authorities of the United Kingdom as referred to in Article LAW.EUROPOL.59 [Working and administrative arrangements].

2. The Parties agree on the establishment, implementation and operation of a secure communication line for the purpose of the exchange of information between Europol and the competent authorities of the United Kingdom.

3. Administrative arrangements between Europol and the competent authorities of the United Kingdom as referred to in Article LAW.EUROPOL.58 [Exchange of classified and sensitive non-classified information] shall regulate the secure communication line's terms and conditions of use.

#### Article LAW.EUROPOL.57: Liability for unauthorised or incorrect personal data processing

1. The competent authorities shall be liable, in accordance with their respective legal frameworks, for any damage caused to an individual as a result of legal or factual errors in information exchanged. In order to avoid liability under their respective legal frameworks vis-à-vis an injured party, neither Europol nor the competent authorities of the United Kingdom may plead that the other competent authority had transferred inaccurate information.

2. If damages are awarded either against Europol or against the competent authorities of the United Kingdom because of the use by either of them of information which was erroneously communicated by the other, or communicated as a result of a failure on the part of the other to comply with their obligations, the amount paid as compensation under paragraph 1 either by Europol or by the competent authorities of the United Kingdom shall be repaid by the other, unless the information was used in breach of this Title.

3. Europol and the competent authorities of the United Kingdom shall not require each other to pay for punitive or non-compensatory damages under paragraphs 1 and 2.

#### Article LAW.EUROPOL.58: Exchange of classified and sensitive non-classified information

The exchange and protection of classified and sensitive non-classified information, if necessary under this Title, shall be regulated in working and administrative arrangements as referred to in

Article LAW.EUROPOL.59 [Working and administrative arrangements] between Europol and the competent authorities of the United Kingdom.

#### Article LAW.EUROPOL.59: Working and administrative arrangements

1. The details of cooperation between the United Kingdom and Europol, as appropriate to complement and implement the provisions of this Title, shall be the subject of working arrangements in accordance with Article 23(4) of the Europol Regulation and administrative arrangements in accordance with Article 25(1) of the Europol Regulation concluded between Europol and the competent authorities of the United Kingdom.

2. Without prejudice to any provision in this Title and while reflecting the status of the United Kingdom as not being a Member State, Europol and the competent authorities of the United Kingdom shall, subject to a decision by Europol's Management Board, include, in working arrangements or administrative arrangements, as the case may be, provisions complementing or implementing this Title, in particular allowing for:

- (a) consultations between Europol and one or more representatives of the national contact point of the United Kingdom on policy issues and matters of common interest for the purpose of realising their objectives and coordinating their respective activities, and of furthering cooperation between Europol and the competent authorities of the United Kingdom;
- (b) the participation of one or more representatives of the United Kingdom as observer or observers in specific meetings of the Europol Heads of Unit meetings in line with the rules of proceedings of such meetings;
- (c) the association of one or more representatives of the United Kingdom to operational analysis projects, in accordance with the rules set out by the appropriate Europol governance bodies;
- (d) the specification of liaison officers' tasks, their rights and obligations and the costs involved; or
- (e) cooperation between the competent authorities of the United Kingdom and Europol in the event of privacy or security breaches.

3. The substance of working and administrative arrangements may be set out together in one document.

#### Article LAW.EUROPOL.60: Notification of implementation

1. The United Kingdom and Europol shall each make publicly available a document setting out in an intelligible form the provisions regarding the processing of personal data transferred under this Title including the means available for the exercise of the rights of data subjects, and shall each ensure that a copy of that document be provided to the other.

2. Where not already in place, the United Kingdom and Europol shall adopt rules specifying how compliance with the provisions regarding the processing of personal data will be enforced in practice. The United Kingdom and Europol shall each send a copy of those rules to the other and to the respective supervisory authorities.

#### Article LAW.EUROPOL.61: Powers of Europol

Nothing in this Title shall be construed as creating an obligation on Europol to cooperate with the competent authorities of the United Kingdom beyond Europol's competence as set out in the relevant Union law.

## TITLE VI: COOPERATION WITH EUROJUST

### Article LAW.EUROJUST.61: Objective

The objective of this Title is to establish cooperation between Eurojust and the competent authorities of the United Kingdom in combating serious crimes as referred to in Article LAW.EUROJUST.63 [Forms of crime].

### Article LAW.EUROJUST.62: Definitions

For the purposes of this Title, the following definitions apply:

- (a) “Eurojust” means the European Union Agency for Criminal Justice Cooperation, set up under Regulation (EU) 2018/1727<sup>80</sup> (the “Eurojust Regulation”);
- (b) “competent authority” means, for the Union, Eurojust, represented by the College or a National Member and, for the United Kingdom, a domestic authority with responsibilities under domestic law relating to the investigation and prosecution of criminal offences;
- (c) “College” means the College of Eurojust, as referred to in the Eurojust Regulation;
- (d) “National Member” means the National Member seconded to Eurojust by each Member State, as referred to in the Eurojust Regulation;
- (e) “Assistant” means a person who may assist a National Member and the National Member’s Deputy, or the Liaison Prosecutor, as referred to in the Eurojust Regulation and in Article LAW.EUROJUST.66(3) [Liaison Prosecutor] respectively;
- (f) “Liaison Prosecutor” means a public prosecutor seconded by the United Kingdom to Eurojust and subject to the domestic law of the United Kingdom as regards the public prosecutor’s status;
- (g) “Liaison Magistrate” means a magistrate posted by Eurojust to the United Kingdom in accordance with Article LAW.EUROJUST.67 [Liaison Magistrate];
- (h) “Domestic Correspondent for Terrorism Matters” means the contact point designated by the United Kingdom in accordance with Article LAW.EUROJUST.65 [Contact points to Eurojust], responsible for handling correspondence related to terrorism matters.

### Article LAW.EUROJUST.63: Forms of crime

1. The cooperation established under this Title relates to the forms of serious crime within the competence of Eurojust, as listed in ANNEX LAW-4, including related criminal offences.
2. Related criminal offences are the criminal offences committed in order to procure the means of committing forms of serious crime referred to in paragraph 1, criminal offences committed

---

<sup>80</sup> Regulation (EU) 2018/1727 of the European Parliament and of the Council of 14 November 2018 on the European Union Agency for Criminal Justice Cooperation (Eurojust), and replacing and repealing Council Decision 2002/187/JHA (OJ EU L 295, 21.11.2018, p. 138)

in order to facilitate or commit such serious crimes, and criminal offences committed to ensure impunity for such serious crimes.

3. Where the list of forms of serious crime for which Eurojust is competent under Union law is changed, the Specialised Committee on Law Enforcement and Judicial Cooperation may, upon a proposal from the Union, amend ANNEX LAW-4 accordingly from the date when the change to Eurojust's competence enters into effect.

#### Article LAW.EUROJUST.64: Scope of cooperation

The Parties shall ensure that Eurojust and the competent authorities of the United Kingdom cooperate in the fields of activity set out in Articles 2 and 54 of the Eurojust Regulation and in this Title.

#### Article LAW.EUROJUST.65: Contact points to Eurojust

1. The United Kingdom shall put in place or appoint at least one contact point to Eurojust within the competent authorities of the United Kingdom.

2. The United Kingdom shall designate one of its contact points as the United Kingdom Domestic Correspondent for Terrorism Matters.

#### Article LAW.EUROJUST.66: Liaison Prosecutor

1. To facilitate the cooperation established under this Title, the United Kingdom shall second a Liaison Prosecutor to Eurojust.

2. The mandate and the duration of the secondment shall be determined by the United Kingdom.

3. The Liaison Prosecutor may be assisted by up to five Assistants, reflecting the volume of cooperation. When necessary, Assistants may replace the Liaison Prosecutor or act on the Liaison Prosecutor's behalf.

4. The United Kingdom shall inform Eurojust of the nature and extent of the judicial powers of the Liaison Prosecutor and the Liaison Prosecutor's Assistants within the United Kingdom to accomplish their tasks in accordance with this Title. The United Kingdom shall establish the competence of its Liaison Prosecutor and the Liaison Prosecutor's Assistants to act in relation to foreign judicial authorities.

5. The Liaison Prosecutor and the Liaison Prosecutor's Assistants shall have access to the information contained in the domestic criminal record, or in any other register of the United Kingdom, in accordance with domestic law in the case of a prosecutor or person of equivalent competence.

6. The Liaison Prosecutor and the Liaison Prosecutor's Assistants shall have the power to contact the competent authorities of the United Kingdom directly.

7. The number of Assistants referred to in paragraph 3 of this Article, the details of the tasks of the Liaison Prosecutor and the Liaison Prosecutor's Assistants, their rights and obligations and the costs involved shall be governed by a working arrangement concluded between Eurojust and the

competent authorities of the United Kingdom as referred to in Article LAW.EUROJUST.75 [Working arrangement].

8. The working documents of the Liaison Prosecutor and the Liaison Prosecutor's Assistants shall be held inviolable by Eurojust.

#### Article LAW.EUROJUST.67: Liaison Magistrate

1. For the purpose of facilitating judicial cooperation with the United Kingdom in cases in which Eurojust provides assistance, Eurojust may post a Liaison Magistrate to the United Kingdom, in accordance with Article 53 of the Eurojust Regulation.

2. The details of the Liaison Magistrate's tasks referred to in paragraph 1 of this Article, the Liaison Magistrate's rights and obligations and the costs involved, shall be governed by a working arrangement concluded between Eurojust and the competent authorities of the United Kingdom as referred to in Article LAW.EUROJUST.75 [Working arrangement].

#### Article LAW.EUROJUST.68: Operational and strategic meetings

1. The Liaison Prosecutor, the Liaison Prosecutor's Assistants, and representatives of other competent authorities of the United Kingdom, including the contact point to Eurojust, may participate in meetings with regard to strategic matters at the invitation of the President of Eurojust and in meetings with regard to operational matters with the approval of the National Members concerned.

2. National Members, their Deputies and Assistants, the Administrative Director of Eurojust and Eurojust staff may attend meetings organised by the Liaison Prosecutor, the Liaison Prosecutor's Assistants, or other competent authorities of the United Kingdom, including the contact point to Eurojust.

#### Article LAW.EUROJUST.69: Exchange of non-personal data

Eurojust and the competent authorities of the United Kingdom may exchange any non-personal data in so far as those data are relevant for the cooperation under this Title, and subject to any restrictions pursuant to Article LAW.EUROJUST.74 [Exchange of classified and sensitive non-classified information].

#### Article LAW.EUROJUST.70: Exchange of personal data

1. Personal data requested and received by competent authorities under this Title shall be processed by them only for the objectives set out in Article LAW.EUROJUST.61 [Objective], for the specific purposes referred to in paragraph 2 of this Article and subject to the restrictions on access or further use referred to in paragraph 3 of this Article.

2. The transferring competent authority shall clearly indicate, at the latest at the moment of transferring personal data, the specific purpose or purposes for which the data are being transferred.

3. The transferring competent authority may indicate, at the moment of transferring personal data, any restriction on access thereto or the use to be made thereof, in general or specific terms, including as regards its onward transfer, erasure or destruction after a certain period of time, or its

further processing. Where the need for such restrictions becomes apparent after the personal data have been provided, the transferring authority shall inform the receiving authority accordingly.

4. The receiving competent authority shall comply with any restriction on access or further use of the personal data indicated by the transferring competent authority as provided for in paragraph 3.

#### Article LAW.EUROJUST.71: Channels of transmission

1. Information shall be exchanged:

- (a) either between the Liaison Prosecutor or the Liaison Prosecutor's Assistants or, if none is appointed or otherwise available, the United Kingdom's contact point to Eurojust and the National Members concerned or the College;
- (b) if Eurojust has posted a Liaison Magistrate to the United Kingdom, between the Liaison Magistrate and any competent authority of the United Kingdom; in that event, the Liaison Prosecutor shall be informed of any such information exchanges; or
- (c) directly between a competent authority in the United Kingdom and the National Members concerned or the College; in that event, the Liaison Prosecutor and, if applicable, the Liaison Magistrate shall be informed of any such information exchanges.

2. Eurojust and the competent authorities of the United Kingdom may agree to use other channels for the exchange of information in particular cases.

3. Eurojust and the competent authorities of the United Kingdom shall each ensure that their respective representatives are authorised to exchange information at the appropriate level and in accordance with United Kingdom law and the Eurojust Regulation respectively, and are adequately screened.

#### Article LAW.EUROJUST.72: Onward transfers

The competent authorities of the United Kingdom and Eurojust shall not communicate any information provided by the other to any third country or international organisation without the consent of whichever of the competent authorities of the United Kingdom or Eurojust provided the information and without appropriate safeguards regarding the protection of personal data.

#### Article LAW.EUROJUST.73: Liability for unauthorised or incorrect personal data processing

1. The competent authorities shall be liable, in accordance with their respective legal frameworks, for any damage caused to an individual as a result of legal or factual errors in information exchanged. In order to avoid liability under their respective legal frameworks vis-à-vis an injured party, neither Eurojust nor the competent authorities of the United Kingdom may plead that the other competent authority had transferred inaccurate information.

2. If damages are awarded against any competent authority because of its use of information which was erroneously communicated by the other, or communicated as a result of a failure on the part of the other to comply with their obligations, the amount paid as compensation under paragraph 1 by the competent authority shall be repaid by the other, unless the information was used in breach of this Title.

3. Eurojust and the competent authorities of the United Kingdom shall not require each other to pay for punitive or non-compensatory damages under paragraphs 1 and 2.

Article LAW.EUROJUST.74: Exchange of classified and sensitive non-classified information

The exchange and protection of classified and sensitive non-classified information, if necessary under this Title, shall be regulated by a working arrangement as referred to in Article LAW.EUROJUST.75 [Working arrangement] concluded between Eurojust and the competent authorities of the United Kingdom.

Article LAW.EUROJUST.75: Working arrangement

The modalities of cooperation between the Parties as appropriate to implement this Title shall be the subject of a working arrangement concluded between Eurojust and the competent authorities of the United Kingdom in accordance with Articles 47(3) and 56(3) of the Eurojust Regulation.

Article LAW.EUROJUST.76: Powers of Eurojust

Nothing in this Title shall be construed as creating an obligation on Eurojust to cooperate with the competent authorities of the United Kingdom beyond Eurojust's competence as set out in the relevant Union law.

*TITLE VII: SURRENDER*

Article LAW.SURR.76: Objective

The objective of this Title is to ensure that the extradition system between the Member States, on the one side, and the United Kingdom, on the other side, is based on a mechanism of surrender pursuant to an arrest warrant in accordance with the terms of this Title.

Article LAW.SURR.77: Principle of proportionality

Cooperation through the arrest warrant shall be necessary and proportionate, taking into account the rights of the requested person and the interests of the victims, and having regard to the seriousness of the act, the likely penalty that would be imposed and the possibility of a State taking measures less coercive than the surrender of the requested person particularly with a view to avoiding unnecessarily long periods of pre-trial detention.

Article LAW.SURR.78: Definitions

For the purposes of this Title, the following definitions apply:

- (a) "arrest warrant" means a judicial decision issued by a State with a view to the arrest and surrender by another State of a requested person, for the purposes of conducting a criminal prosecution or executing a custodial sentence or detention order;
- (b) "judicial authority" means an authority that is, under domestic law, a judge, a court or a public prosecutor. A public prosecutor is considered a judicial authority only to the extent that domestic law so provides;
- (c) "executing judicial authority" means the judicial authority of the executing State which is competent to execute the arrest warrant by virtue of the domestic law of that State;



- (d) “issuing judicial authority” means the judicial authority of the issuing State which is competent to issue an arrest warrant by virtue of the domestic law of that State.

#### Article LAW.SURR.79: Scope

1. An arrest warrant may be issued for acts punishable by the law of the issuing State by a custodial sentence or a detention order for a maximum period of at least 12 months or, where a sentence has been passed or a detention order has been made, for sentences or detention orders of at least four months.

2. Without prejudice to paragraphs 3 and 4, surrender is subject to the condition that the acts for which the arrest warrant has been issued constitute an offence under the law of the executing State, whatever the constituent elements or however it is described.

3. Subject to Article LAW.SURR.80 [Grounds for mandatory non-execution of the arrest warrant], points (b) to (h) of Article LAW.SURR.81(1) [Other grounds for non-execution of the arrest warrant], Article LAW.SURR.82 [Political offence exception], Article LAW.SURR.83 [Nationality exception] and Article LAW.SURR.84 [Guarantees to be given by the issuing State in particular cases], a State shall not refuse to execute an arrest warrant issued in relation to the following behaviour where such behaviour is punishable by deprivation of liberty or a detention order of a maximum period of at least 12 months:

(a) the behaviour of any person who contributes to the commission by a group of persons acting with a common purpose of one or more offences in the field of terrorism referred to in Articles 1 and 2 of the European Convention on the Suppression of Terrorism, done at Strasbourg on 27 January 1977, or in relation to illicit trafficking in narcotic drugs and psychotropic substances, or murder, grievous bodily injury, kidnapping, illegal restraint, hostage-taking or rape, even where that person does not take part in the actual execution of the offence or offences concerned; such contribution must be intentional and made with the knowledge that the participation will contribute to the achievement of the group’s criminal activities; or

(b) terrorism as defined in ANNEX LAW-7.

4. The United Kingdom and the Union, acting on behalf of any of its Member States, may each notify the Specialised Committee on Law Enforcement and Judicial Cooperation that, on the basis of reciprocity, the condition of double criminality referred to in paragraph 2 will not be applied, provided that the offence on which the warrant is based is:

(a) one of the offences listed in paragraph 5, as defined by the law of the issuing State; and

(b) punishable in the issuing State by a custodial sentence or a detention order for a maximum period of at least three years.

5. The offences referred to in paragraph 4 are:

- participation in a criminal organisation;
- terrorism as defined in ANNEX LAW-7;
- trafficking in human beings;

- sexual exploitation of children and child pornography;
- illicit trafficking in narcotic drugs and psychotropic substances;
- illicit trafficking in weapons, munitions and explosives;
- corruption, including bribery;
- fraud, including that affecting the financial interests of the United Kingdom, a Member State or the Union;
- laundering of the proceeds of crime;
- counterfeiting currency;
- computer-related crime;
- environmental crime, including illicit trafficking in endangered animal species and endangered plant species and varieties;
- facilitation of unauthorised entry and residence;
- murder;
- grievous bodily injury;
- illicit trade in human organs and tissue;
- kidnapping, illegal restraint and hostage-taking;
- racism and xenophobia;
- organised or armed robbery;
- illicit trafficking in cultural goods, including antiques and works of art;
- swindling;
- racketeering and extortion;
- counterfeiting and piracy of products;
- forgery of administrative documents and trafficking therein;
- forgery of means of payment;
- illicit trafficking in hormonal substances and other growth promoters;

- illicit trafficking in nuclear or radioactive materials;
- trafficking in stolen vehicles;
- rape;
- arson;
- crimes within the jurisdiction of the International Criminal Court;
- unlawful seizure of aircraft, ships or spacecraft; and
- sabotage.

Article LAW.SURR.80: Grounds for mandatory non-execution of the arrest warrant

The execution of the arrest warrant shall be refused:

- (a) if the offence on which the arrest warrant is based is covered by an amnesty in the executing State, where that State had jurisdiction to prosecute the offence under its own criminal law;
- (b) if the executing judicial authority is informed that the requested person has been finally judged by a State in respect of the same acts, provided that, if a penalty has been imposed, it has been enforced, is in the process of being enforced or can no longer be enforced under the law of the sentencing State; or
- (c) if the person who is the subject of the arrest warrant may not, owing to the person's age, be held criminally responsible for the acts on which the arrest warrant is based under the law of the executing State.

Article LAW.SURR.81: Other grounds for non-execution of the arrest warrant

1. The execution of the arrest warrant may be refused:

- (a) if, in one of the cases referred to in Article LAW.SURR.79(2) [Scope], the act on which the arrest warrant is based does not constitute an offence under the law of the executing State; however, in relation to taxes or duties, customs and exchange, the execution of the arrest warrant shall not be refused on the grounds that the law of the executing State does not impose the same kind of tax or duty or does not contain the same type of rules as regards taxes or duties, customs and exchange regulations as the law of the issuing State;
- (b) if the person who is the subject of the arrest warrant is being prosecuted in the executing State for the same act as that on which the arrest warrant is based;
- (c) if the judicial authorities of the executing State have decided either not to prosecute for the offence on which the arrest warrant is based or to halt proceedings, or if a final judgment which prevents further proceedings has been passed upon the requested person in a State in respect of the same acts;

- (d) if the criminal prosecution or punishment of the requested person is statute-barred under the law of the executing State and the acts fall within the jurisdiction of that State under its own criminal law;
- (e) if the executing judicial authority is informed that the requested person has been finally judged by a third country in respect of the same acts provided that, if a penalty has been imposed, it has been enforced, is in the process of being enforced or can no longer be enforced under the law of the sentencing country;
- (f) if the arrest warrant has been issued for the purposes of execution of a custodial sentence or detention order and the requested person is staying in, or is a national or a resident of the executing State and that State undertakes to execute the sentence or detention order in accordance with its domestic law; if consent of the requested person to the transfer of the sentence or detention order to the executing State is required, the executing State may refuse to execute the arrest warrant only after the requested person consents to the transfer of the sentence or detention order;
- (g) if the arrest warrant relates to offences which:
  - (i) are regarded by the law of the executing State as having been committed in whole or in part in the territory of the executing State or in a place treated as such or
  - (ii) have been committed outside the territory of the issuing State, and the law of the executing State does not allow prosecution for the same offences if committed outside its territory;
- (h) if there are reasons to believe on the basis of objective elements that the arrest warrant has been issued for the purpose of prosecuting or punishing a person on the grounds the person's sex, race, religion, ethnic origin, nationality, language, political opinions or sexual orientation, or that that person's position may be prejudiced for any of those reasons;
- (i) if the arrest warrant has been issued for the purpose of executing a custodial sentence or a detention order and the requested person did not appear in person at the trial resulting in the decision, unless the arrest warrant states that the person, in accordance with further procedural requirements defined in the domestic law of the issuing State:
  - (i) in due time:
    - (A) either was summoned in person and thereby informed of the scheduled date and place of the trial which resulted in the decision, or by other means actually received official information of the scheduled date and place of that trial in such a manner that it was unequivocally established that the person was aware of the date and place of the scheduled trial;
    - and
    - (B) was informed that a decision may be handed down if that person did not appear for the trial;

or

(ii) being aware of the date and place of the scheduled trial, had given a mandate to a lawyer, who was either appointed by the person concerned or by the State, to defend him or her at the trial, and was indeed defended by that lawyer at the trial;

or

(iii) after being served with the decision and being expressly informed about the right to a retrial or appeal in which the person has the right to participate and which allows the merits of the case, including fresh evidence, to be re-examined, and which may lead to the original decision being reversed:

(A) expressly stated that the person did not contest the decision;

or

(B) did not request a retrial or appeal within the applicable time frame;

or

(iv) was not personally served with the decision but:

(A) will be personally served with it without delay after the surrender and will be expressly informed of the right to a retrial or appeal in which the person has the right to participate and which allows the merits of the case, including fresh evidence, to be re-examined, and which may lead to the original decision being reversed;

and

(B) will be informed of the time frame within which the person has to request such a retrial or appeal, as mentioned in the relevant arrest warrant.

2. Where the arrest warrant is issued for the purpose of executing a custodial sentence or detention order under the conditions in point (i) (iv) of paragraph 1 and the person concerned has not previously received any official information about the existence of the criminal proceedings against him or her, that person may, when being informed about the content of the arrest warrant, request to receive a copy of the judgment before being surrendered. Immediately after having been informed about the request, the issuing authority shall provide the copy of the judgment via the executing authority to the person concerned. The request of the person concerned shall neither delay the surrender procedure nor delay the decision to execute the arrest warrant. The provision of the judgment to the person concerned shall be for information purposes only; it shall not be regarded as a formal service of the judgment nor actuate any time limits applicable for requesting a retrial or appeal.

3. Where a person is surrendered under the conditions in point (i) (iv) of paragraph 1 and that person has requested a retrial or appeal, until those proceedings are finalised the detention of that person awaiting such retrial or appeal shall be reviewed in accordance with the domestic law of the issuing State, either on a regular basis or upon request of the person concerned. Such a review shall in particular include the possibility of suspension or interruption of the detention. The retrial or appeal shall begin within due time after the surrender.

#### Article LAW.SURR.82: Political offence exception

1. The execution of an arrest warrant may not be refused on the grounds that the offence may be regarded by the executing State as a political offence, as an offence connected with a political offence or as an offence inspired by political motives.
2. However, the United Kingdom and the Union, acting on behalf of any of its Member States, may each notify the Specialised Committee on Law Enforcement and Judicial Cooperation that paragraph 1 will be applied only in relation to:
  - (a) the offences referred to in Articles 1 and 2 of the European Convention on the Suppression of Terrorism;
  - (b) offences of conspiracy or association to commit one or more of the offences referred to in Articles 1 and 2 of the European Convention on the Suppression of Terrorism, if those offences of conspiracy or association correspond to the description of behaviour referred to in Article LAW.SURR.79(3) [Scope] of this Agreement; and
  - (c) terrorism as defined in ANNEX LAW-7 to this Agreement.
3. Where an arrest warrant has been issued by a State having made a notification as referred to in paragraph 2 or by a State on behalf of which such a notification has been made, the State executing the arrest warrant may apply reciprocity.

#### Article LAW.SURR.83: Nationality exception

1. The execution of an arrest warrant may not be refused on the grounds that the requested person is a national of the executing State.
2. The United Kingdom, and the Union, acting on behalf of any of its Member States, may each notify the Specialised Committee on Law Enforcement and Judicial Cooperation that that State's own nationals will not be surrendered or that the surrender of their own nationals will be authorised only under certain specified conditions. The notification shall be based on reasons related to the fundamental principles or practice of the domestic legal order of the United Kingdom or the State on behalf of which a notification was made. In such a case, the Union, on behalf of any of its Member States or the United Kingdom, as the case may be, may notify the Specialised Committee on Law Enforcement and Judicial Cooperation within a reasonable time after the receipt of the other Party's notification that the executing judicial authorities of the Member State or the United Kingdom, as the case may be, may refuse to surrender its nationals to that State or that surrender shall be authorised only under certain specified conditions.
3. In circumstances where a State has refused to execute an arrest warrant on the basis that, in the case of the United Kingdom, it has made a notification or, in the case of a Member State, the Union has made a notification on its behalf, as referred to in paragraph 2, that State shall consider instituting proceedings against its own national which are commensurate with the subject matter of the arrest warrant, having taken into account the views of the issuing State. In circumstances where a judicial authority decides not to institute such proceedings, the victim of the offence on which the arrest warrant is based shall be able to receive information on the decision in accordance with the applicable domestic law.
4. Where a State's competent authorities institute proceedings against its own national in accordance with paragraph 3, that State shall ensure that its competent authorities are able to take

appropriate measures to assist the victims and witnesses in circumstances where they are residents of another State, particularly with regard to the way in which the proceedings are conducted.

Article LAW.SURR.84: Guarantees to be given by the issuing State in particular cases

The execution of the arrest warrant by the executing judicial authority may be subject to the following guarantees:

- (a) if the offence on which the arrest warrant is based is punishable by a custodial life sentence or a lifetime detention order in the issuing State, the executing State may make the execution of the arrest warrant subject to the condition that the issuing State gives a guarantee deemed sufficient by the executing State that the issuing State will review the penalty or measure imposed, on request or at the latest after 20 years, or will encourage the application of measures of clemency for which the person is entitled to apply under the law or practice of the issuing State, aiming at the non-execution of such penalty or measure;
- (b) if a person who is the subject of an arrest warrant for the purposes of prosecution is a national or resident of the executing State, the surrender of that person may be subject to the condition that the person, after being heard, is returned to the executing State in order to serve there the custodial sentence or detention order passed against him or her in the issuing State; if the consent of the requested person to the transfer of the sentence or detention order to the executing State is required, the guarantee that the person be returned to the executing State to serve the person's sentence is subject to the condition that the requested person, after being heard, consents to be returned to the executing State;
- (c) if there are substantial grounds for believing that there is a real risk to the protection of the fundamental rights of the requested person, the executing judicial authority may require, as appropriate, additional guarantees as to the treatment of the requested person after the person's surrender before it decides whether to execute the arrest warrant.

Article LAW.SURR.85: Recourse to the central authority

1. The United Kingdom and the Union, acting on behalf of any of its Member States, may each notify the Specialised Committee on Law Enforcement and Judicial Cooperation of, in the case of the United Kingdom, the its central authority and, in the case of the Union, the central authority for each State, having designated such an authority, or, if the legal system of the relevant State so provides, of more than one central authority to assist the competent judicial authorities.

2. When notifying the Specialised Committee on Law Enforcement and Judicial Cooperation under paragraph 1, the United Kingdom and the Union, acting on behalf of any of its Member States, may each indicate that, as a result of the organisation of the internal judicial system of the relevant States, the central authority or central authorities are responsible for the administrative transmission and receipt of arrest warrants as well as for all other official correspondence relating to the administrative transmission and receipt of arrest warrants. Such indication shall be binding upon all the authorities of the issuing State.

Article LAW.SURR.86: Content and form of the arrest warrant

1. The arrest warrant shall contain the following information set out in accordance with the form contained in ANNEX LAW-5:

- (a) the identity and nationality of the requested person;

- (b) the name, address, telephone and fax numbers and e-mail address of the issuing judicial authority;
- (c) evidence of an enforceable judgment, an arrest warrant or any other enforceable judicial decision having the same effect that fall within the scope of Article LAW.SURR.79 [Scope];
- (d) the nature and legal classification of the offence, particularly in respect of Article LAW.SURR.79 [Scope];
- (e) a description of the circumstances in which the offence was committed, including the time, place and degree of participation in the offence by the requested person;
- (f) the penalty imposed, if there is a final judgment, or the prescribed scale of penalties for the offence under the law of the issuing State; and
- (g) if possible, other consequences of the offence.

2. The arrest warrant shall be translated into the official language or one of the official languages of the executing State. The United Kingdom and the Union, acting on behalf of any of its Member States, may each notify the Specialised Committee on Law Enforcement and Judicial Cooperation that a translation in one or more other official languages of a State will be accepted.

#### Article LAW.SURR.87: Transmission of an arrest warrant

If the location of the requested person is known, the issuing judicial authority may transmit the arrest warrant directly to the executing judicial authority.

#### Article LAW.SURR.88: Detailed procedures for transmitting an arrest warrant

1. If the issuing judicial authority does not know which authority is the competent executing judicial authority, it shall make the requisite enquiries, in order to obtain that information from the executing State.
2. The issuing judicial authority may request the International Criminal Police Organisation (“Interpol”) to transmit an arrest warrant.
3. The issuing judicial authority may transmit the arrest warrant by any secure means capable of producing written records under conditions allowing the executing State to establish the authenticity of the arrest warrant.
4. All difficulties concerning the transmission or the authenticity of any document needed for the execution of the arrest warrant shall be dealt with by direct contacts between the judicial authorities involved, or, where appropriate, with the involvement of the central authorities of the States.
5. If the authority which receives an arrest warrant is not competent to act upon it, it shall automatically forward the arrest warrant to the competent authority in its State and shall inform the issuing judicial authority accordingly.



#### Article LAW.SURR.89: Rights of a requested person

1. If a requested person is arrested for the purpose of the execution of an arrest warrant, the executing judicial authority, in accordance with its domestic law, shall inform that person of the arrest warrant and of its contents, and also of the possibility of consenting to surrender to the issuing State.
2. A requested person who is arrested for the purpose of the execution of an arrest warrant and who does not speak or understand the language of the arrest warrant proceedings shall have the right to be assisted by an interpreter and to be provided with a written translation in the native language of the requested person or in any other language which that person speaks or understands, in accordance with the domestic law of the executing State.
3. A requested person shall have the right to be assisted by a lawyer in accordance with the domestic law of the executing State upon arrest.
4. The requested person shall be informed of the person's right to appoint a lawyer in the issuing State for the purpose of assisting the lawyer in the executing State in the arrest warrant proceedings. This paragraph is without prejudice to the time limits set out in Article LAW.SURR.101 [Time limits for surrender of the person].
5. A requested person who is arrested shall have the right to have the consular authorities of that person's State of nationality, or if that person is stateless, the consular authorities of the State where that person usually resides, informed of the arrest without undue delay and to communicate with those authorities, if that person so wishes.

#### Article LAW.SURR.90: Keeping the person in detention

When a person is arrested on the basis of an arrest warrant, the executing judicial authority shall take a decision on whether the requested person should remain in detention, in accordance with the law of the executing State. The person may be released provisionally at any time in accordance with the domestic law of the executing State, provided that the competent authority of that State takes all the measures it deems necessary to prevent the person from absconding.

#### Article LAW.SURR.91: Consent to surrender

1. If the arrested person indicates that he or she consents to surrender, that consent and, if appropriate, the express renunciation of entitlement to the speciality rule referred to in Article LAW.SURR.105(2) [Possible prosecution for other offences] must be given before the executing judicial authority, in accordance with the domestic law of the executing State.
2. Each State shall adopt the measures necessary to ensure that the consent and, where appropriate, the renunciation referred to in paragraph 1 are established in such a way as to show that the person concerned has expressed them voluntarily and in full awareness of the consequences. To that end, the requested person shall have the right to a lawyer.
3. The consent and, where appropriate, the renunciation referred to in paragraph 1 shall be formally recorded in accordance with the procedure laid down by the domestic law of the executing State.
4. In principle, consent may not be revoked. Each State may provide that the consent and, if appropriate, the renunciation referred to in paragraph 1 of this Article may be revoked in

accordance with the rules applicable under its domestic law. In such a case, the period between the date of the consent and that of its revocation shall not be taken into consideration in establishing the time limits laid down in Article LAW.SURR.101 [Time limits for surrender of the person]. The United Kingdom and the Union, acting on behalf of any of its Member States, may each notify the Specialised Committee on Law Enforcement and Judicial Cooperation that it wishes to have recourse to this possibility, specifying the procedures whereby revocation of the consent is possible and any amendments to those procedures.

#### Article LAW.SURR.92: Hearing of the requested person

Where the arrested person does not consent to surrender as referred to in Article LAW.SURR.91 [Consent to surrender], that person shall be entitled to be heard by the executing judicial authority, in accordance with the law of the executing State.

#### Article LAW.SURR.93: Surrender decision

1. The executing judicial authority shall decide whether the person is to be surrendered within the time limits and in accordance with the conditions defined in this Title, in particular the principle of proportionality as set out in Article LAW.SURR.77 [Principle of proportionality].
2. If the executing judicial authority finds the information communicated by the issuing State to be insufficient to allow it to decide on surrender, it shall request that the necessary supplementary information, in particular with respect to Article LAW.SURR. 77 [Principle of proportionality], Articles LAW.SURR.80 [Grounds for mandatory non-execution of the arrest warrant] to LAW.SURR.82 [Political offence exception], Article LAW.SURR.84 [Guarantees to be given by the issuing State in particular cases] and Article LAW.SURR.86 [Content and form of the arrest warrant], be furnished as a matter of urgency and may fix a time limit for the receipt thereof, taking into account the need to observe the time limits provided for in Article LAW.SURR.95 [Time limits and procedures for the decision to execute the arrest warrant].
3. The issuing judicial authority may forward any additional useful information to the executing judicial authority at any time.

#### Article LAW.SURR.94: Decision in the event of multiple requests

1. If two or more States have issued a European arrest warrant or an arrest warrant for the same person, the decision as to which of those arrest warrants is to be executed shall be taken by the executing judicial authority, with due consideration of all the circumstances, especially the relative seriousness of the offences and place of the offences, the respective dates of the arrest warrants or European arrest warrants and whether they have been issued for the purposes of prosecution or for the execution of a custodial sentence or detention order, and of legal obligations of Member States deriving from Union law regarding, in particular, the principles of freedom of movement and non-discrimination on grounds of nationality.
2. The executing judicial authority of a Member State may seek the advice of Eurojust when making the choice referred to in paragraph 1.
3. In the event of a conflict between an arrest warrant and a request for extradition presented by a third country, the decision as to whether the arrest warrant or the extradition request takes precedence shall be taken by the competent authority of the executing State with due consideration of all the circumstances, in particular those referred to in paragraph 1 and those mentioned in the applicable convention.

4. This Article is without prejudice to the States' obligations under the Statute of the International Criminal Court.

Article LAW.SURR.95: Time limits and procedures for the decision to execute the arrest warrant

1. An arrest warrant shall be dealt with and executed as a matter of urgency.
2. In cases where the requested person consents to surrender, the final decision on the execution of the arrest warrant shall be taken within ten days after the consent was given.
3. In other cases, the final decision on the execution of the arrest warrant shall be taken within 60 days after the arrest of the requested person.
4. Where in specific cases the arrest warrant cannot be executed within the time limits laid down in paragraphs 2 or 3, the executing judicial authority shall immediately inform the issuing judicial authority of that fact, giving the reasons for the delay. In such cases, the time limits may be extended by a further 30 days.
5. As long as the executing judicial authority has not taken a final decision on the arrest warrant, it shall ensure that the material conditions necessary for the effective surrender of the person remain fulfilled.
6. Reasons must be given for any refusal to execute an arrest warrant.

Article LAW.SURR.96: Situation pending the decision

1. Where the arrest warrant has been issued for the purpose of conducting a criminal prosecution, the executing judicial authority shall either:
  - (a) agree that the requested person should be heard according to Article LAW.SURR.97 [Hearing the person pending the decision]; or
  - (b) agree to the temporary transfer of the requested person.
2. The conditions and the duration of the temporary transfer shall be determined by mutual agreement between the issuing and executing judicial authorities.
3. In the case of temporary transfer, the person must be able to return to the executing State to attend hearings which concern that person as part of the surrender procedure.

Article LAW.SURR.97: Hearing the person pending the decision

1. The requested person shall be heard by a judicial authority. To that end, the requested person shall be assisted by a lawyer designated in accordance with the law of the issuing State.
2. The requested person shall be heard in accordance with the law of the executing State and with the conditions determined by mutual agreement between the issuing and executing judicial authorities.
3. The competent executing judicial authority may assign another judicial authority of its State to take part in the hearing of the requested person in order to ensure the proper application of this Article.

#### Article LAW.SURR.98: Privileges and immunities

1. Where the requested person enjoys a privilege or immunity regarding jurisdiction or execution in the executing State, the time limits referred to in Article LAW.SURR.95 [Time limits and procedures for the decision to execute the arrest warrant] only start running when, or if, the executing judicial authority is informed of the fact that the privilege or immunity has been waived.
2. The executing State shall ensure that the material conditions necessary for effective surrender are fulfilled when the person no longer enjoys such privilege or immunity.
3. Where power to waive the privilege or immunity lies with an authority of the executing State, the executing judicial authority shall request that authority to exercise that power without delay. Where power to waive the privilege or immunity lies with an authority of another State, third country or international organisation, the issuing judicial authority shall request that authority to exercise that power.

#### Article LAW.SURR.99: Competing international obligations

1. This Agreement does not prejudice the obligations of the executing State where the requested person has been extradited to that State from a third country and where that person is protected by provisions of the arrangement under which that person was extradited concerning the speciality rule. The executing State shall take all necessary measures for requesting without delay the consent of the third country from which the requested person was extradited so that the requested person can be surrendered to the State which issued the arrest warrant. The time limits referred to in Article LAW.SURR.95 [Time limits and procedures for the decision to execute the arrest warrant] do not start running until the day on which the speciality rule ceases to apply.
2. Pending the decision of the third country from which the requested person was extradited, the executing State shall ensure that the material conditions necessary for effective surrender remain fulfilled.

#### Article LAW.SURR.100: Notification of the decision

The executing judicial authority shall notify the issuing judicial authority immediately of the decision on the action to be taken on the arrest warrant.

#### Article LAW.SURR.101: Time limits for surrender of the person

1. The requested person shall be surrendered as soon as possible on a date agreed between the authorities concerned.
2. The requested person shall be surrendered no later than ten days after the final decision on the execution of the arrest warrant.
3. If the surrender of the requested person within the time limit in paragraph 2 is prevented by circumstances beyond the control of any of the States, the executing and issuing judicial authorities shall immediately contact each other and agree on a new surrender date. In that event, the surrender shall take place within ten days of the new date thus agreed.
4. The surrender may exceptionally be temporarily postponed for serious humanitarian reasons, for example if there are substantial grounds for believing that the surrender would manifestly endanger the requested person's life or health. The execution of the arrest warrant shall

take place as soon as those grounds have ceased to exist. The executing judicial authority shall immediately inform the issuing judicial authority and agree on a new surrender date. In that event, the surrender shall take place within ten days of the new date - agreed.

5. Upon the expiry of the time limits referred to in paragraphs 2 to 4, if the requested person is still being held in custody, that person shall be released. The executing and issuing judicial authorities shall contact each other as soon as it appears that a person is to be released under this paragraph and agree the arrangements for the surrender of that person.

#### Article LAW.SURR.102: Postponed or conditional surrender

1. After deciding to execute the arrest warrant, the executing judicial authority may postpone the surrender of the requested person so that the requested person may be prosecuted in the executing State or, if the requested person has already been sentenced, so that the requested person may serve, a sentence passed for an act other than that referred to in the arrest warrant in the territory of the executing State.

2. Instead of postponing the surrender, the executing judicial authority may temporarily surrender the requested person to the issuing State under conditions to be determined by mutual agreement between the executing and the issuing judicial authorities. The agreement shall be made in writing and the conditions shall be binding on all the authorities in the issuing State.

#### Article LAW.SURR.103: Transit

1. Each State shall permit the transit through its territory of a requested person who is being surrendered provided that it has been given information on:

- (a) the identity and nationality of the person subject to the arrest warrant;
- (b) the existence of an arrest warrant;
- (c) the nature and legal classification of the offence; and
- (d) the description of the circumstances of the offence, including the date and place.

2. The State, on behalf of which a notification has been made in accordance with Article LAW.SURR.83(2) [Nationality exception] to the effect that its own nationals will not be surrendered or that surrender will be authorised only under certain specified conditions, may refuse the transit of its own nationals through its territory under the same terms or submit it to the same conditions.

3. The States shall designate an authority responsible for receiving transit requests and the necessary documents, as well as any other official correspondence relating to transit requests.

4. The transit request and the information referred to in paragraph 1 may be addressed to the authority designated pursuant to paragraph 3 by any means capable of producing a written record. The State of transit shall notify its decision by the same procedure.

5. This Article does not apply in the case of transport by air without a scheduled stopover. However, if an unscheduled landing occurs, the issuing State shall provide the authority designated pursuant to paragraph 3 with the information referred to in paragraph 1.

6. Where a transit concerns a person who is to be extradited from a third country to a State, this Article applies *mutatis mutandis*. In particular, references to an “arrest warrant” shall be treated as references to an “extradition request”.

#### Article LAW.SURR.104: Deduction of the period of detention served in the executing State

1. The issuing State shall deduct all periods of detention arising from the execution of an arrest warrant from the total period of detention to be served in the issuing State as a result of a custodial sentence or detention order being passed.

2. All information concerning the duration of the detention of the requested person on the basis of the arrest warrant shall be transmitted by the executing judicial authority or the central authority designated under Article LAW.SURR.85 [Recourse to the central authority] to the issuing judicial authority at the time of the surrender.

#### Article LAW.SURR.105: Possible prosecution for other offences

1. The United Kingdom and the Union, acting on behalf of any of its Member States, may each notify the Specialised Committee on Law Enforcement and Judicial Cooperation that, in relations with other States to which the same notification applies, consent is presumed to have been given for the prosecution, sentencing or detention of a person with a view to the carrying out of a custodial sentence or detention order for an offence committed prior to the person’s surrender, other than that for which that person was surrendered, unless in a particular case the executing judicial authority states otherwise in its decision on surrender.

2. Except in the cases referred to in paragraphs 1 and 3, a person surrendered may not be prosecuted, sentenced or otherwise deprived of liberty for an offence committed prior to that person's surrender other than that for which the person was surrendered.

3. Paragraph 2 of this Article does not apply in the following cases:

- (a) the person, having had an opportunity to leave the territory of the State to which that person has been surrendered, has not done so within 45 days of that person's final discharge or has returned to that territory after leaving it;
- (b) the offence is not punishable by a custodial sentence or detention order;
- (c) the criminal proceedings do not give rise to the application of a measure restricting personal liberty;
- (d) the person could be liable to a penalty or a measure not involving the deprivation of liberty, in particular a financial penalty or a measure in lieu of a financial penalty, even if the penalty or measure may give rise to a restriction of the person’s personal liberty;
- (e) the person consented to be surrendered, where appropriate at the same time as the person renounced the speciality rule, in accordance with Article LAW.SURR.91 [Consent to surrender];
- (f) the person, after the person's surrender, has expressly renounced entitlement to the speciality rule with regard to specific offences preceding the person's surrender; renunciation must be given before the competent judicial authority of the issuing State and be recorded in accordance with that State's domestic law; the renunciation must be drawn up in such a way

as to make clear that the person concerned has given it voluntarily and in full awareness of the consequences; to that end, the person shall have the right to a lawyer; and

- (g) the executing judicial authority which surrendered the person gives its consent in accordance with paragraph 4 of this Article.

4. A request for consent shall be submitted to the executing judicial authority, accompanied by the information referred to in Article LAW.SURR.86(1) [Content and form of the arrest warrant] and a translation as referred to in Article LAW.SURR.86(2) [Content and form of the arrest warrant]. Consent shall be given where the offence for which it is requested is itself subject to surrender in accordance with the provisions of this Title. Consent shall be refused on the grounds referred to in Article LAW.SURR.80 [Grounds for mandatory non-execution of the arrest warrant] and otherwise may be refused only on the grounds referred to in Article LAW.SURR.81 [Other grounds for non-execution of the arrest warrant], or Article LAW.SURR.82(2) [Political offence exception] and Article LAW.SURR.83(2) [Nationality exception]. The decision shall be taken no later than 30 days after receipt of the request. For the situations laid down in Article LAW.SURR.84 [Guarantees to be given by the issuing State in particular cases] the issuing State must give the guarantees provided for therein.

#### Article LAW.SURR.106: Surrender or subsequent extradition

1. The United Kingdom and the Union, acting on behalf of any of its Member States, may each notify the Specialised Committee on Law Enforcement and Judicial Cooperation that, in relations with other States to which the same notification applies, the consent for the surrender of a person to a State other than the executing State pursuant to an arrest warrant or European arrest warrant issued for an offence committed prior to that person's surrender is presumed to have been given, unless in a particular case the executing judicial authority states otherwise in its decision on surrender.

2. In any case, a person who has been surrendered to the issuing State pursuant to an arrest warrant or European arrest warrant may be surrendered to a State other than the executing State pursuant to an arrest warrant or European arrest warrant issued for any offence committed prior to the person's surrender without the consent of the executing State in the following cases:

- (a) the requested person, having had an opportunity to leave the territory of the State to which that person has been surrendered, has not done so within 45 days of that person's final discharge, or has returned to that territory after leaving it;
- (b) the requested person consents to be surrendered to a State other than the executing State pursuant to an arrest warrant or European arrest warrant; consent must be given before the competent judicial authorities of the issuing State and be recorded in accordance with that State's domestic law; it must be drawn up in such a way as to make clear that the person concerned has given it voluntarily and in full awareness of the consequences; to that end, the requested person shall have the right to a lawyer; and
- (c) the requested person is not subject to the speciality rule, in accordance with points (a), (e), (f) or (g) of Article LAW.SURR.105(3) [Possible prosecution for other offences].

3. The executing judicial authority shall consent to the surrender to another State in accordance with the following rules:



- (a) the request for consent shall be submitted in accordance with Article LAW.SURR.87 [Transmission of an arrest warrant], accompanied by the information set out in Article LAW.SURR.86(1) [Content and form of the arrest warrant] and a translation as referred to in Article LAW.SURR.86(2) [Content and form of the arrest warrant];
- (b) consent shall be given where the offence for which it is requested is itself subject to surrender in accordance with the provisions of this Agreement;
- (c) the decision shall be taken no later than 30 days after receipt of the request; and
- (d) consent shall be refused on the grounds referred to in Article LAW.SURR.80 [Grounds for mandatory non-execution of the arrest warrant] and otherwise may be refused only on the grounds referred to in Article LAW.SURR.81 [Other grounds for non-execution of the arrest warrant], Article LAW.SURR.82(2) [Political offence exception] and Article LAW.SURR.83(2) [Nationality exception].

4. For the situations referred to in Article LAW.SURR.84 [Guarantees to be given by the issuing State in particular cases], the issuing State shall give the guarantees provided for therein.

5. Notwithstanding paragraph 1, a person who has been surrendered pursuant to an arrest warrant shall not be extradited to a third country without the consent of the competent authority of the State which surrendered the person. Such consent shall be given in accordance with the Conventions by which that State is bound, as well as with its domestic law.

#### Article LAW.SURR.107: Handing over of property

1. At the request of the issuing judicial authority or on its own initiative, the executing judicial authority shall, in accordance with its domestic law, seize and hand over property which:

- (a) may be required as evidence; or
- (b) has been acquired by the requested person as a result of the offence.

2. The property referred to in paragraph 1 shall be handed over even if the arrest warrant cannot be carried out owing to the death or escape of the requested person.

3. If the property referred to in paragraph 1 is liable to seizure or confiscation in the territory of the executing State, that State may, if the property is needed in connection with pending criminal proceedings, temporarily retain it or hand it over to the issuing State on condition that it is returned.

4. Any rights which the executing State or third parties may have acquired in the property referred to in paragraph 1 shall be preserved. Where such rights exist, the issuing State shall return the property without charge to the executing State as soon as the criminal proceedings have been terminated.

#### Article LAW.SURR.108: Expenses

1. Expenses incurred in the territory of the executing State for the execution of an arrest warrant shall be borne by that State.

2. All other expenses shall be borne by the issuing State.



#### Article LAW.SURR.109: Relation to other legal instruments

1. Without prejudice to their application in relations between States and third countries, this Title, from the date of entry into force of this Agreement, replaces the corresponding provisions of the following conventions applicable in the field of extradition in relations between the United Kingdom, on the one side, and Member States, on the other side:

- (a) the European Convention on Extradition, done at Paris on 13 December 1957, and its additional protocols; and
- (b) the European Convention on the Suppression of Terrorism, as far as extradition is concerned.

2. Where the Conventions referred to in paragraph 1 apply to the territories of States or to territories for whose external relations a State is responsible to which this Title does not apply, those Conventions continue to govern the relations existing between those territories and the other States.

#### Article LAW.SURR.110: Review of notifications

When carrying out the joint review of this Title as referred to in Article LAW.OTHER.135(1) [Review and evaluation], the Parties shall consider the need to maintain the notifications made under Article LAW.SURR.79(4) [Scope], Article LAW.SURR.82(2) [Political offence exception] and Article LAW.SURR.83(2) [Nationality exception]. If the notifications referred to in Article LAW.SURR.83(2) [Nationality exception] are not renewed, they shall expire five years after the date of entry into force of this Agreement. Notifications as referred to in Article LAW.SURR.83(2) [Nationality exception] may only be renewed or newly made during the three months prior to the fifth anniversary of the entry into force of this Agreement and, subsequently, every five years thereafter, provided that the conditions set out in Article LAW.SURR.83(2) [Nationality exception] are met at that time.

#### Article LAW.SURR.111: Ongoing arrest warrants in case of disapplication

Notwithstanding Article LAW.GEN.5 [Scope of cooperation where a Member State no longer participates in analogous measure under Union law]; Article.LAW.OTHER.136 [Termination] and Article LAW.OTHER.137 [Suspension], the provisions of this Title apply in respect of arrest warrants where the requested person was arrested before the disapplication of this Title for the purposes of the execution of an arrest warrant, irrespective of the decision of the executing judicial authority as to whether the requested person is to remain in detention or be provisionally released.

#### Article LAW.SURR.112: Application to existing European arrest warrants

This Title shall apply in respect of European arrest warrants issued in accordance with Council Framework Decision [2002/584/JHA](#)<sup>81</sup> by a State before the end of the transition period where the requested person has not been arrested for the purpose of its execution before the end of the transition period.

### *TITLE VIII: MUTUAL ASSISTANCE*

---

<sup>81</sup> Council Framework Decision [2002/584/JHA](#) of 13 June 2002 on the European arrest warrant and the surrender procedures between Member States (OJ EU L 190, 18.7.2002, p. 1).

#### Article LAW.MUTAS.113: Objective

1. The objective of this Title is to supplement the provisions, and facilitate the application between Member States, on the one side, and the United Kingdom, on the other side, of:
  - (a) the European Convention on Mutual Assistance in Criminal Matters, done at Strasbourg on 20 April 1959 (the "European Mutual Assistance Convention");
  - (b) the Additional Protocol to the European Mutual Assistance Convention, done at Strasbourg on 17 March 1978; and
  - (c) the Second Additional Protocol to the European Mutual Assistance Convention, done at Strasbourg on 8 November 2001.
2. This Title is without prejudice to the provisions of Title IX [Exchange of information extracted from the criminal record], which takes precedence over this Title.

#### Article LAW.MUTAS.114: Definition of competent authority

For the purposes of this Title, "competent authority" means any authority which is competent to send or receive requests for mutual assistance in accordance with the provisions of the European Mutual Assistance Convention and its Protocols and as defined by States in their respective declarations addressed to the Secretary General of the Council of Europe. "Competent authority" also includes Union bodies notified in accordance with point (c) of Article LAW.OTHER.134(7) [Notifications]; with regard to such Union bodies, the provisions of this Title apply accordingly.

#### Article LAW.MUTAS.115: Form for a request for mutual assistance

1. The Specialised Committee on Law Enforcement and Judicial Cooperation shall undertake to establish a standard form for requests for mutual assistance by adopting an annex to this Agreement.
2. If the Specialised Committee on Law Enforcement and Judicial Cooperation has adopted a decision in accordance with paragraph 1, requests for mutual assistance shall be made using the standard form.
3. The Specialised Committee on Law Enforcement and Judicial Cooperation may amend the standard form for requests for mutual assistance as may be necessary.

#### Article LAW.MUTAS.116 Conditions for a request for mutual assistance

1. The competent authority of the requesting State may only make a request for mutual assistance if it is satisfied that the following conditions are met:
  - (a) the request is necessary and proportionate for the purpose of the proceedings, taking into account the rights of the suspected or accused person; and
  - (b) the investigative measure or investigative measures indicated in the request could have been ordered under the same conditions in a similar domestic case.
2. The requested State may consult the requesting State if the competent authority of the requested State is of the view that the conditions in paragraph 1 are not met. After the consultation,

the competent authority of the requesting State may decide to withdraw the request for mutual assistance.

#### Article LAW.MUTAS.117: Recourse to a different type of investigative measure

1. Wherever possible, the competent authority of the requested State shall consider recourse to an investigative measure other than the measure indicated in the request for mutual assistance if:

- (a) the investigative measure indicated in the request does not exist under the law of the requested State; or
- (b) the investigative measure indicated in the request would not be available in a similar domestic case.

2. Without prejudice to the grounds for refusal available under the European Mutual Assistance Convention and its Protocols and under Article LAW.MUTAS.119 [*Ne bis in idem*], paragraph 1 of this Article does not apply to the following investigative measures, which shall always be available under the law of the requested State:

- (a) the obtaining of information contained in databases held by police or judicial authorities that is directly accessible by the competent authority of the requested State in the framework of criminal proceedings;
- (b) the hearing of a witness, expert, victim, suspected or accused person or third party in the territory of the requested State;
- (c) any non-coercive investigative measure as defined under the law of the requested State; and
- (d) the identification of persons holding a subscription to a specified phone number or IP address.

3. The competent authority of the requested State may also have recourse to an investigative measure other than the measure indicated in the request for mutual assistance if the investigative measure selected by the competent authority of the requested State would achieve the same result by less intrusive means than the investigative measure indicated in the request.

4. If the competent authority of the requested State decides to have recourse to a measure other than that indicated in the request for mutual assistance as referred to in paragraphs 1 or 3, it shall first inform the competent authority of the requesting State, which may decide to withdraw or supplement the request.

5. If the investigative measure indicated in the request does not exist under the law of the requested State or would not be available in a similar domestic case, and there is no other investigative measure which would have the same result as the investigative measure requested, the competent authority of the requested State shall inform the competent authority of the requesting State that it is not possible to provide the assistance requested.

#### Article LAW.MUTAS.118: Obligation to inform

The competent authority of the requested State shall inform the competent authority of the requesting State by any means and without undue delay if:

- (a) it is impossible to execute the request for mutual assistance due to the fact that the request is incomplete or manifestly incorrect; or
- (b) the competent authority of the requested State, in the course of the execution of the request for mutual assistance, considers without further enquiries that it may be appropriate to carry out investigative measures not initially foreseen, or which could not be specified when the request for mutual assistance was made, in order to enable the competent authority of the requesting State to take further action in the specific case.

Article LAW.MUTAS.119: *Ne bis in idem*

Mutual assistance may be refused, in addition to the grounds for refusal provided for under the European Mutual Assistance Convention and its Protocols, on the ground that the person in respect of whom the assistance is requested and who is subject to criminal investigations, prosecutions or other proceedings, including judicial proceedings, in the requesting State, has been finally judged by another State in respect of the same acts, provided that, if a penalty has been imposed, it has been enforced, is in the process of being enforced or can no longer be enforced under the law of the sentencing State.

Article LAW.MUTAS.120: Time limits

1. The requested State shall decide whether to execute the request for mutual assistance as soon as possible and in any event no later than 45 days after the receipt of the request and shall inform the requesting State of its decision.
2. A request for mutual assistance shall be executed as soon as possible and in any event no later than 90 days after the decision referred to in paragraph 1 of this Article or after the consultation referred to in Article LAW.MUTAS.116(2) [Conditions for a request for mutual assistance] has taken place.
3. If it is indicated in the request for mutual assistance that, due to procedural deadlines, the seriousness of the offence or other particularly urgent circumstances, a shorter time limit than that provided for in paragraph 1 or 2 is necessary, or if it is indicated in the request that a measure for mutual assistance is to be carried out on a specific date, the requested State shall take as full account as possible of that requirement.
4. If a request for mutual assistance is made to take provisional measures pursuant to Article 24 of the Second Additional Protocol to the European Mutual Assistance Convention, the competent authority of the requested State shall decide on the provisional measure, and shall communicate that decision to the competent authority of the requesting State, as soon as possible after the receipt of the request. Before lifting any provisional measure taken pursuant to this Article, the competent authority of the requested State, wherever possible, shall give the competent authority of the requesting State an opportunity to present its reasons in favour of continuing the measure.
5. If in a specific case, the time limit provided for in paragraph 1 or 2, or the time limit or specific date referred to in paragraph 3 cannot be met, or the decision on taking provisional measures in accordance with paragraph 4 is delayed, the competent authority of the requested State shall, without delay, inform the competent authority of the requesting State by any means, giving the reasons for the delay, and shall consult with the competent authority of the requesting State on the appropriate timing to execute the request for mutual assistance.

6. The time limits referred to in this Article do not apply if the request for mutual assistance is made in relation to any of the following offences and infringements that fall within scope of the European Mutual Assistance Convention and its Protocols, as defined in the law of the requesting State:

- (a) speeding, if no injury or death was caused to another person and if the excess speed was not significant;
- (b) failure to wear a seatbelt;
- (c) failure to stop at a red light or other mandatory stop signal;
- (d) failure to wear a safety helmet; or
- (e) using a forbidden lane (such as the forbidden use of an emergency lane, a lane reserved for public transport, or a lane closed down for road works).

7. The Specialised Committee on Law Enforcement and Judicial Cooperation shall keep the operation of paragraph 6 under review. It shall undertake to set time limits for the requests to which paragraph 6 applies within three years of the entry into force of this Agreement, taking into account the volume of requests. It may also decide that paragraph 6 shall no longer apply.

#### Article LAW.MUTAS.121: Transmission of requests for mutual assistance

1. In addition to the channels of communication provided for under the European Mutual Assistance Convention and its Protocols, if direct transmission is provided for under their respective provisions, requests for mutual assistance may also be transmitted directly by public prosecutors in the United Kingdom to competent authorities of the Member States.

2. In addition to the channels of communication provided for under the European Mutual Assistance Convention and its Protocols, in urgent cases, any request for mutual assistance, as well as spontaneous information, may be transmitted via Europol or Eurojust, in line with the provisions in the respective Titles of this Agreement.

#### Article LAW.MUTAS.122: Joint Investigation Teams

If the competent authorities of States set up a Joint Investigation Team, the relationship between Member States within the Joint Investigation Team shall be governed by Union law, notwithstanding the legal basis referred to in the Agreement on the setting up of the Joint Investigation Team.

### *TITLE IX: EXCHANGE OF CRIMINAL RECORD INFORMATION*

#### Article LAW.EXINF.120: Objective

1. The objective of this Title is to enable the exchange between the Member States, on the one side, and the United Kingdom, on the other side, of information extracted from the criminal record.

2. In the relations between the United Kingdom and the Member States, the provisions of this Title:

- (a) supplement Articles 13 and 22(2) of the European Convention on Mutual Assistance in Criminal Matters and its Additional Protocols of 17 March 1978 and 8 November 2001; and
- (b) replace Article 22(1) of the European Convention on Mutual Assistance in Criminal Matters, as supplemented by Article 4 of its Additional Protocol of 17 March 1978.

3. In the relations between a Member State, on the one side, and the United Kingdom, on the other side, each shall waive the right to rely on its reservations to Article 13 of the European Convention on Mutual Assistance in Criminal Matters and to Article 4 of its Additional Protocol of 17 March 1978.

#### Article LAW.EXINF.121: Definitions

For the purposes of this Title, the following definitions apply:

- (a) “conviction” means any final decision of a criminal court against a natural person in respect of a criminal offence, to the extent that the decision is entered in the criminal record of the convicting State;
- (b) “criminal proceedings” means the pre-trial stage, the trial stage and the execution of a conviction;
- (c) “criminal record” means the domestic register or registers recording convictions in accordance with domestic law.

#### Article LAW.EXINF.122: Central authorities

Each State shall designate one or more central authorities that shall be competent for the exchange of information extracted from the criminal record pursuant to this Title and for the exchanges referred to in Article 22(2) of the European Convention on Mutual Assistance in Criminal Matters.

#### Article LAW.EXINF.123: Notifications

1. Each State shall take the necessary measures to ensure that all convictions handed down within its territory are accompanied, when provided to its criminal record, by information on the nationality or nationalities of the convicted person if that person is a national of another State.
2. The central authority of each State shall inform the central authority of any other State of all criminal convictions handed down within its territory in respect of nationals of the latter State, as well as of any subsequent alterations or deletions of information contained in the criminal record, as entered in the criminal record. The central authorities of the States shall communicate such information to each other at least once per month.
3. If the central authority of a State becomes aware of the fact that a convicted person is a national of two or more other States, it shall transmit the relevant information to each of those States, even if the convicted person is a national of the State within whose territory that person was convicted.

#### Article LAW.EXINF.124: Storage of convictions

1. The central authority of each State shall store all information notified under Article LAW.EXINF.123 [Notifications].

2. The central authority of each State shall ensure that if a subsequent alteration or deletion is notified under Article LAW.EXINF.123(2) [Notifications], an identical alteration or deletion is made to the information stored in accordance with paragraph 1 of this Article.

3. The central authority of each State shall ensure that only information which has been updated in accordance with paragraph 2 of this Article is provided when replying to requests made under Article LAW.EXINF.125 [Requests for information].

#### Article LAW.EXINF.125: Requests for information

1. If information from the criminal record of a State is requested at domestic level for the purposes of criminal proceedings against a person or for any purposes other than that of criminal proceedings, the central authority of that State may, in accordance with its domestic law, submit a request to the central authority of another State for information and related data to be extracted from the criminal record.

2. If a person asks the central authority of a State other than the State of the person's nationality for information on the person's own criminal record, that central authority shall submit a request to the central authority of the State of the person's nationality for information and related data to be extracted from the criminal record in order to be able to include that information and related data in the extract to be provided to the person concerned.

#### Article LAW.EXINF.126: Replies to requests

1. Replies to requests for information shall be transmitted by the central authority of the requested State to the central authority of the requesting State as soon as possible and in any event within 20 working days from the date the request was received.

2. The central authority of each State shall reply to requests made for purposes other than that of criminal proceedings in accordance with its domestic law.

3. Notwithstanding paragraph 2, when replying to requests made for the purposes of recruitment for professional or organised voluntary activities involving direct and regular contacts with children, the States shall include information on the existence of criminal convictions for offences related to sexual abuse or sexual exploitation of children, child pornography, solicitation of children for sexual purposes, including inciting, aiding and abetting or attempting to commit any of those offences, as well as information on the existence of any disqualification from exercising activities involving direct and regular contacts with children arising from those criminal convictions.

#### Article LAW.EXINF.127: Channel of communication

The exchange between States of information extracted from the criminal record shall take place electronically in accordance with the technical and procedural specifications laid down in ANNEX LAW-6.

#### Article LAW.EXINF.128: Conditions for the use of personal data

1. Each State may use personal data received in reply to its request under Article LAW.EXINF.126 [Replies to requests] only for the purposes for which they were requested.

2. If the information was requested for any purposes other than that of criminal proceedings, personal data received under Article LAW.EXINF.126 [Replies to requests] may be used by the



requesting State in accordance with its domestic law only within the limits specified by the requested State in the form set out in Chapter 2 of ANNEX LAW-6.

3. Notwithstanding paragraphs 1 and 2 of this Article, personal data provided by a State in reply to a request under Article LAW.EXINF.126 [Replies to requests] may be used by the requesting State to prevent an immediate and serious threat to public security.

4. Each State shall ensure that their central authorities do not disclose personal data notified under Article LAW.EXINF.123 [Notifications] to authorities in third countries unless the following conditions are met:

- (a) the personal data are disclosed only on a case-by-case basis;
- (b) the personal data are disclosed to authorities whose functions are directly related to the purposes for which the personal data are disclosed under point (c) of this paragraph;
- (c) the personal data are disclosed only if necessary:
  - (i) for the purposes of criminal proceedings;
  - (ii) for any purposes other than that of criminal proceedings; or
  - (iii) to prevent an immediate and serious threat to public security;
- (d) the personal data may be used by the requesting third country only for the purposes for which the information was requested and within the limits specified by the State that notified the personal data under Article LAW.EXINF.123 [Notifications]; and
- (e) the personal data are disclosed only if the central authority, having assessed all the circumstances surrounding the transfer of the personal data to the third country, concludes that appropriate safeguards exist to protect the personal data.

5. This Article does not apply to personal data obtained by a State under this Title and originating from that State.

#### *TITLE X: ANTI-MONEY LAUNDERING AND COUNTER TERRORIST FINANCING*

##### Article LAW.AML.127: Objective

The objective of this Title is to support and strengthen action by the Union and the United Kingdom to prevent and combat money laundering and terrorist financing.

##### Article LAW.AML.128: Measures to prevent and combat money laundering and terrorist financing

1. The Parties agree to support international efforts to prevent and combat money laundering and terrorist financing. The Parties recognise the need to cooperate in preventing the use of their financial systems to launder the proceeds of all criminal activity, including drug trafficking and corruption, and to combat terrorist financing.

2. The Parties shall exchange relevant information, as appropriate within their respective legal frameworks.



3. The Parties shall each maintain a comprehensive regime to combat money laundering and terrorist financing, and regularly review the need to enhance that regime, taking account of the principles and objectives of the Financial Action Task Force Recommendations.

Article LAW.AML.129 Beneficial ownership transparency for corporate and other legal entities

1. For the purposes of this Article, the following definitions apply:

- (a) “beneficial owner” means any individual in respect of a corporate entity who, in accordance with the Party’s laws and regulations:
- (i) exercises or has the right to exercise ultimate control over the management of the entity;
  - (ii) ultimately owns or controls directly or indirectly more than 25% of the voting rights or shares or other ownership interests in the entity, without prejudice to each Party’s right to define a lower percentage; or
  - (iii) otherwise controls or has the right to control the entity;

In respect of legal entities such as foundations, Anstalt and limited liability partnerships, each Party has the right to determine similar criteria for identifying the beneficial owner, or, if they choose, to apply the definition set out in point (a) of Article AML.130(1) [Beneficial Ownership transparency of legal arrangements], having regard to the form and structure of such entities.

In respect of other legal entities not mentioned above, each Party shall take into account the different forms and structures of such entities and the levels of money laundering and terrorist financing risks associated with such entities, with a view to deciding the appropriate levels of beneficial ownership transparency.

- (b) “basic information about a beneficial owner” means the beneficial owner’s name, month and year of birth, country of residence and nationality, as well as the nature and extent of the interest held, or control exercised, over the entity by the beneficial owner;
- (c) “competent authorities” means:
- (i) public authorities, including Financial Intelligence Units, that have designated responsibilities for combating money laundering or terrorist financing;
  - (ii) public authorities that have the function of investigating or prosecuting money laundering, associated predicate offences or terrorist financing, or that have the function of tracing, seizing or freezing and confiscating criminal assets;
  - (iii) public authorities that have supervisory or monitoring responsibilities aimed at ensuring compliance with anti-money laundering or counter terrorist financing requirements.

This definition is without prejudice to each Party’s right to identify additional competent authorities that can access information about beneficial owners.

2. Each Party shall ensure that legal entities in its territory maintain adequate, accurate and up-to-date information about beneficial owners. Each Party shall put in place mechanisms to ensure that their competent authorities have timely access to such information.

3. Each Party shall establish or maintain a central register holding adequate, up-to-date and accurate information about beneficial owners. In the case of the Union, the central registers shall be set up at the level of the Member States. This obligation shall not apply in respect of legal entities listed on a stock exchange that are subject to disclosure requirements regarding an adequate level of transparency. Where no beneficial owner is identified in respect of an entity, the register shall hold alternative information, such as a statement that no beneficial owner has been identified or details of the natural person or persons who hold the position of senior managing official in the legal entity.
4. Each Party shall ensure that the information held in its central register or registers is made available to its competent authorities without restriction and in a timely manner.
5. Each Party shall ensure that basic information about beneficial owners is made available to any member of the public. Limited exceptions may be made to the public availability of information under this paragraph in cases where public access would expose the beneficial owner to disproportionate risks, such as risks of fraud, kidnapping, blackmail, extortion, harassment, violence or intimidation, or where the beneficial owner is a minor or otherwise legally incapable.
6. Each Party shall ensure that there are effective, proportionate and dissuasive sanctions against legal or natural persons who fail to comply with requirements imposed on them in connection with the matters referred to in this Article.
7. Each Party shall ensure that its competent authorities are able to provide the information referred to in paragraphs 2 and 3 to the competent authorities of the other Party in a timely and effective manner and free of charge. To that end, the Parties shall consider ways to ensure the secure exchange of information.

#### Article LAW.AML.130 Beneficial ownership transparency of legal arrangements

1. For the purposes of this Article, the following definitions apply:
  - (a) “beneficial owner” means the settlor, the protector (if any), trustees, the beneficiary or class of beneficiaries, any person holding an equivalent position in relation to a legal arrangement with a structure or function similar to an express trust, and any other natural person exercising ultimate effective control over a trust or a similar legal arrangement;
  - (b) “competent authorities” means:
    - (i) public authorities, including Financial Intelligence Units, that have designated responsibilities for combating money laundering or terrorist financing;
    - (ii) public authorities that have the function of investigating or prosecuting money laundering, associated predicate offences or terrorist financing or the function of tracing, seizing or freezing and confiscating criminal assets;
    - (iii) public authorities that have supervisory or monitoring responsibilities aimed at ensuring compliance with anti-money laundering or counter terrorist financing requirements.

This definition is without prejudice to each Party’s right to identify additional competent authorities that can access information about beneficial owners.

2. Each Party shall ensure that trustees of express trusts maintain adequate, accurate and up-to-date information about beneficial owners. These measures shall also apply to other legal arrangements identified by each Party as having a structure or function similar to trusts.

3. Each Party shall put in place mechanisms to ensure that its competent authorities have timely access to adequate, accurate and up-to-date information about beneficial owners of express trusts and other legal arrangements with a structure or function similar to trusts in its territory.

4. If the beneficial ownership information about trusts or similar legal arrangements is held in a central register, the State concerned shall ensure that the information is adequate, accurate and up-to-date, and that competent authorities have timely and unrestricted access to such information. The Parties shall endeavour to consider ways to provide access to beneficial ownership information about trusts and similar legal arrangements to individuals or organisations who can demonstrate a legitimate interest in seeing such information.

5. Each Party shall ensure that there are effective, proportionate and dissuasive sanctions against legal or natural persons who fail to comply with requirements imposed on them in connection with the matters referred to in this Article.

6. Each Party shall ensure that its competent authorities are able to provide the information referred to in paragraph 3 to the competent authorities of the other Party in a timely and effective manner and free of charge. To that end, the Parties shall consider ways to ensure the secure exchange of information.

#### *TITLE XI: FREEZING AND CONFISCATION*

##### Article LAW.CONFISC.1: Objective and principles of cooperation

1. The objective of this Title is to provide for cooperation between the United Kingdom, on the one side, and the Member States, on the other side, to the widest extent possible for the purposes of investigations and proceedings aimed at the freezing of property with a view to subsequent confiscation thereof and investigations and proceedings aimed at the confiscation of property within the framework of proceedings in criminal matters. This does not preclude other cooperation pursuant to Article LAW.CONFISC.10(5) and (6) [Obligation to confiscate]. This Title also provides for cooperation with Union bodies designated by the Union for the purposes of this Title.

2. Each State shall comply, under the conditions provided for in this Title, with requests from another State:

- (a) for the confiscation of specific items of property, as well as for the confiscation of proceeds consisting in a requirement to pay a sum of money corresponding to the value of proceeds;
- (b) for investigative assistance and provisional measures with a view to either form of confiscation referred to in point (a).

3. Investigative assistance and provisional measures sought under point (b) of paragraph 2 shall be carried out as permitted by and in accordance with the domestic law of the requested State. Where the request concerning one of these measures specifies formalities or procedures which are necessary under the domestic law of the requesting State, even if unfamiliar to the requested State, the latter shall comply with such requests to the extent that the action sought is not contrary to the fundamental principles of its domestic law.

4. The requested State shall ensure that the requests coming from another State to identify, trace, freeze or seize the proceeds and instrumentalities, receive the same priority as those made in the framework of domestic procedures.

5. When requesting confiscation, investigative assistance and provisional measures for the purposes of confiscation, the requesting State shall ensure that the principles of necessity and proportionality are respected.

6. The provisions of this Title apply in place of the “international cooperation” Chapters of the Council of Europe Convention on Laundering, Search, Seizure and Confiscation of the Proceeds from Crime and on the Financing of Terrorism, done at Warsaw on 16 May 2005 (“the 2005 Convention”) and the Convention on Laundering, Search, Seizure and Confiscation of the Proceeds from Crime, done at Strasbourg on 8 November 1990 (“the 1990 Convention”). Article LAW.CONFISC.2 [Definitions] of this Agreement replaces the corresponding definitions in Article 1 of the 2005 Convention and Article 1 of the 1990 Convention. The provisions of this Title do not affect the States’ obligations under the other provisions of the 2005 Convention and the 1990 Convention.

#### Article LAW.CONFISC.2: Definitions

For the purposes of this Title, the following definitions apply:

- (a) “confiscation” means a penalty or a measure ordered by a court following proceedings in relation to a criminal offence or criminal offences, resulting in the final deprivation of property;
- (b) “freezing” or “seizure” means temporarily prohibiting the transfer, destruction, conversion, disposition or movement of property or temporarily assuming custody or control of property on the basis of an order issued by a court or other competent authority;
- (c) “instrumentalities” means any property used or intended to be used, in any manner, wholly or in part, to commit a criminal offence or criminal offences;
- (d) “judicial authority” means an authority that is, under domestic law, a judge, a court or a public prosecutor; a public prosecutor is considered a judicial authority only to the extent that domestic law so provides;
- (e) “proceeds” means any economic benefit, derived from or obtained, directly or indirectly, from criminal offences, or an amount of money equivalent to that economic benefit; it may consist of any property as defined in this Article;
- (f) “property” includes property of any description, whether corporeal or incorporeal, movable or immovable, and legal documents or instruments evidencing title or interest in such property, which the requesting State considers to be:
  - (i) the proceeds of a criminal offence, or its equivalent, whether the full amount of the value of such proceeds or only part of the value of such proceeds;
  - (ii) the instrumentalities of a criminal offence, or the value of such instrumentalities;
  - (iii) subject to confiscation under any other provisions relating to powers of confiscation under the law of the requesting State, following proceedings in relation to a criminal

offence, including third party confiscation, extended confiscation and confiscation without final conviction.

#### Article LAW.CONFISC.3: Obligation to assist

The States shall afford each other, upon request, the widest possible measure of assistance in the identification and tracing of instrumentalities, proceeds and other property liable to confiscation. Such assistance shall include any measure providing and securing evidence as to the existence, location or movement, nature, legal status or value of those instrumentalities, proceeds or other property.

#### Article LAW.CONFISC.4: Requests for information on bank accounts and safe deposit boxes

1. The requested State shall, under the conditions set out in this Article, take the measures necessary to determine, in answer to a request sent by another State, whether a natural or legal person that is the subject of a criminal investigation holds or controls one or more accounts, of whatever nature, in any bank located in its territory and, if so, provide the details of the identified accounts. These details shall in particular include the name of the customer account holder and the IBAN number, and, in the case of safe deposit boxes, the name of the lessee or a unique identification number.

2. The obligation set out in paragraph 1 applies only to the extent that the information is in the possession of the bank keeping the account.

3. In addition to the requirements of Article LAW.CONFISC.25 [Content of request], the requesting State shall, in the request:

- (a) indicate why it considers that the requested information is likely to be of substantial value for the purposes of the criminal investigation into the offence;
- (b) state on what grounds it presumes that banks in the requested State hold the account and specify, to the widest extent possible, which banks and accounts may be involved; and
- (c) include any additional information available which may facilitate the execution of the request.

4. The United Kingdom and the Union, acting on behalf of any of its Member States, may each notify the Specialised Committee on Law Enforcement and Judicial Cooperation that this Article will be extended to accounts held in non-bank financial institutions. Such notifications may be made subject to the principle of reciprocity.

#### Article LAW.CONFISC.5: Requests for information on banking transactions

1. On request by another State, the requested State shall provide the particulars of specified bank accounts and of banking operations which have been carried out during a specified period through one or more accounts specified in the request, including the particulars of any sending or recipient account.

2. The obligation set out in paragraph 1 applies only to the extent that the information is in the possession of the bank keeping the account.

3. In addition to the requirements of Article LAW.CONFISC.25 [Content of request], the requesting State shall indicate in its request why it considers the requested information relevant for the purposes of the criminal investigation into the offence.

4. The requested State may make the execution of such a request dependent on the same conditions as it applies in respect of requests for search and seizure.

5. The United Kingdom and the Union, acting on behalf of any of its Member States, may each notify the Specialised Committee on Law Enforcement and Judicial Cooperation that this Article will be extended to accounts held in non-bank financial institutions. Such notifications may be made subject to the principle of reciprocity.

#### Article LAW.CONFISC.6: Requests for the monitoring of banking transactions

1. The requested State shall ensure that, at the request of another State, it is able to monitor, during a specified period, the banking operations that are being carried out through one or more accounts specified in the request and to communicate the results of the monitoring to the requesting State.

2. In addition to the requirements of Article LAW.CONFISC.25 [Content of request], the requesting State shall indicate in its request why it considers the requested information relevant for the purposes of the criminal investigation into the offence.

3. The decision to monitor shall be taken in each individual case by the competent authorities of the requested State, in accordance with its domestic law.

4. The practical details regarding the monitoring shall be agreed between the competent authorities of the requesting and requested States.

5. The United Kingdom and the Union, acting on behalf of any of its Member States, may each notify the Specialised Committee on Law Enforcement and Judicial Cooperation that this Article will be extended to accounts held in non-bank financial institutions. Such notifications may be made subject to the principle of reciprocity.

#### Article LAW.CONFISC.7: Spontaneous information

Without prejudice to its own investigations or proceedings, a State may without prior request forward to another State information on instrumentalities, proceeds and other property liable to confiscation, where it considers that the disclosure of such information might assist the receiving State in initiating or carrying out investigations or proceedings or might lead to a request by that State under this Title.

#### Article LAW.CONFISC.8: Obligation to take provisional measures

1. At the request of another State which has instituted a criminal investigation or proceedings, or an investigation or proceedings for the purposes of confiscation, the requested State shall take the necessary provisional measures, such as freezing or seizing, to prevent any dealing in, transfer or disposal of property which, at a later stage, may be the subject of a request for confiscation or which might satisfy the request.

2. A State which has received a request for confiscation pursuant to Article LAW.CONFISC.10 [Obligation to confiscate] shall, if so requested, take the measures referred to in paragraph 1 of this

Article in respect of any property which is the subject of the request or which might satisfy the request.

3. Where a request is received under this Article, the requested State shall take all necessary measures to comply with the request without delay and with the same speed and priority as for a similar domestic case and send confirmation without delay and by any means of producing a written record to the requesting State.

4. Where the requesting State states that immediate freezing is necessary since there are legitimate grounds to believe that the property in question will immediately be removed or destroyed, the requested State shall take all necessary measures to comply with the request within 96 hours of receiving the request and send confirmation to the requesting State by any means of producing a written record and without delay.

5. Where the requested State is unable to comply with the time limits under paragraph 4, the requested State shall immediately inform the requesting State, and consult with the requesting State on the appropriate next steps.

6. Any expiration of the time limits under paragraph 4 does not extinguish the requirements placed on the requested State by this Article.

#### Article LAW.CONFISC.9: Execution of provisional measures

1. After the execution of the provisional measures requested in conformity with Article LAW.CONFISC.8(1) [Obligation to take provisional measures], the requesting State shall provide spontaneously and as soon as possible to the requested State all information which may question or modify the extent of those measures. The requesting State shall also provide without delay all complementary information required by the requested State and which is necessary for the implementation of and the follow-up to the provisional measures.

2. Before lifting any provisional measure taken pursuant to Article LAW.CONFISC.8 [Obligation to take provisional measures], the requested State shall, wherever possible, give the requesting State an opportunity to present its reasons in favour of continuing the measure.

#### Article LAW.CONFISC.10: Obligation to confiscate

1. The State which has received a request for confiscation of property situated in its territory shall:

- (a) enforce a confiscation order made by a court of the requesting State in relation to such property; or
- (b) submit the request to its competent authorities for the purpose of obtaining an order of confiscation and, if such an order is granted, enforce it.

2. For the purposes of point (b) of paragraph 1, the States shall, whenever necessary, have competence to institute confiscation proceedings under their own domestic law.

3. Paragraph 1 also applies to confiscation consisting in a requirement to pay a sum of money corresponding to the value of proceeds, if property against which the confiscation can be enforced is located in the requested State. In such cases, when enforcing confiscation pursuant to paragraph 1,



the requested State shall, if payment is not obtained, realise the claim on any property available for that purpose.

4. If a request for confiscation concerns a specific item of property, the requesting State and requested State may agree that the requested State may enforce the confiscation in the form of a requirement to pay a sum of money corresponding to the value of the property.

5. A State shall cooperate to the widest extent possible under its domestic law with a State requesting the execution of measures equivalent to confiscation of property, where the request has not been issued in the framework of proceedings in criminal matters, in so far as such measures are ordered by a judicial authority of the requesting State in relation to a criminal offence, provided that it has been established that the property constitutes proceeds or:

- (a) other property into which the proceeds have been transformed or converted;
- (b) property acquired from legitimate sources, if proceeds have been intermingled, in whole or in part, with such property, up to the assessed value of the intermingled proceeds; or
- (c) income or other benefit derived from the proceeds, from property into which proceeds of crime have been transformed or converted or from property with which the proceeds of crime have been intermingled, up to the assessed value of the intermingled proceeds, in the same manner and to the same extent as proceeds.

6. The measures referred to in paragraph 5 include measures which allow the seizure, detention and forfeiture of property and assets by means of applications to civil courts.

7. The requested State shall take the decision on the execution of the confiscation order without delay, and, without prejudice to paragraph 8 of this Article, no later than 45 days after receiving the request. The requested State shall send confirmation to the requesting State by any means of producing a written record and without delay. Unless grounds for postponement under Article LAW.CONFISC.17 [Postponement] exist, the requested State shall take the concrete measures necessary to execute the confiscation order without delay and, at least, with the same speed and priority as for a similar domestic case.

8. Where the requested State is unable to comply with the time limit under paragraph 7, the requested State shall immediately inform the requesting State, and consult with the requesting State on the appropriate next steps.

9. Any expiration of the time limit under paragraph 7 does not extinguish the requirements placed on the requested State by this Article.

#### Article LAW.CONFISC.11: Execution of confiscation

1. The procedures for obtaining and enforcing the confiscation under Article LAW.CONFISC.10 [Obligation to confiscate] shall be governed by the domestic law of the requested State.

2. The requested State shall be bound by the findings as to the facts in so far as they are stated in a conviction or judicial decision issued by a court of the requesting State or in so far as such conviction or judicial decision is implicitly based on them.



3. If the confiscation consists in the requirement to pay a sum of money, the competent authority of the requested State shall convert the amount thereof into the currency of that State at the rate of exchange applicable at the time when the decision to enforce the confiscation is taken.

#### Article LAW.CONFISC.12: Confiscated property

1. Subject to paragraphs 2 and 3 of this Article, property confiscated pursuant to Articles LAW.CONFISC.10 [Obligation to confiscate] and LAW.CONFISC.11 [Execution of confiscation] shall be disposed of by the requested State in accordance with its domestic law and administrative procedures.

2. When acting on the request made by another State pursuant to Article LAW.CONFISC.10 [Obligation to confiscate], the requested State shall, to the extent permitted by its domestic law and if so requested, give priority consideration to returning the confiscated property to the requesting State so that it can give compensation to the victims of the crime or return such property to their legitimate owners.

3. Where acting on the request made by another State in accordance with Article LAW.CONFISC.10 [Obligation to confiscate], and after having taken into account the right of a victim to restitution or compensation of property pursuant to paragraph 2 of this Article, the requested State shall dispose of the money obtained as a result of the execution of a confiscation order as follows:

- (a) if the amount is equal to or less than EUR 10 000, the amount shall accrue to the requested State; or
- (b) if the amount is greater than EUR 10 000, the requested State shall transfer 50 % of the amount recovered to the requesting State.

4. Notwithstanding paragraph 3, the requesting State and requested State may, on a case-by-case basis, give special consideration to concluding other such agreements or arrangements on disposal of property as they deem appropriate.

#### Article LAW.CONFISC.13: Right of enforcement and maximum amount of confiscation

1. A request for confiscation made under Article LAW.CONFISC.10 [Obligation to confiscate] does not affect the right of the requesting State to enforce the confiscation order itself.

2. Nothing in this Title shall be interpreted as permitting the total value of the confiscation to exceed the amount of the sum of money specified in the confiscation order. If a State finds that this might occur, the States concerned shall enter into consultations to avoid such an effect.

#### Article LAW.CONFISC.14: Imprisonment in default

The requested State shall not impose imprisonment in default or any other measure restricting the liberty of a person as a result of a request under Article LAW.CONFISC.10 [Obligation to confiscate] without the consent of the requesting State.

#### Article LAW.CONFISC.15: Grounds for refusal

1. Cooperation under this Title may be refused if:

- (a) the requested State considers that executing the request would be contrary to the principle of *ne bis in idem*; or
- (b) the offence to which the request relates does not constitute an offence under the domestic law of the requested State if committed within its jurisdiction; however, this ground for refusal applies to cooperation under Articles LAW.CONFISC.3 [Obligation to assist] to LAW.CONFISC.7 [Spontaneous information] only in so far as the assistance sought involves coercive action.

2. The United Kingdom and the Union, acting on behalf of any of its Member States, may each notify the Specialised Committee on Law Enforcement and Judicial Cooperation that, on the basis of reciprocity, the condition of double criminality referred to in point (b) of paragraph 1 of this Article will not be applied provided that the offence giving rise to the request is:

- (a) one of the offences listed in Article LAW.SURR.79(4) [Scope], as defined by the law of the requesting State; and
- (b) punishable by the requesting State by a custodial sentence or a detention order for a maximum period of at least three years.

3. Cooperation under Articles LAW.CONFISC.3 [Obligation to assist] to LAW.CONFISC.7 [Spontaneous information], in so far as the assistance sought involves coercive action, and under Articles LAW.CONFISC.8 [Obligation to take provisional measures] and LAW.CONFISC.9 [Execution of provisional measures] may also be refused if the measures sought could not be taken under the domestic law of the requested State for the purposes of investigations or proceedings in a similar domestic case.

4. Where the domestic law of the requested State so requires, cooperation under Articles LAW.CONFISC.3 [Obligation to assist] to LAW.CONFISC.7 [Spontaneous information], in so far as the assistance sought involves coercive action, and under Articles LAW.CONFISC.8 [Obligation to take provisional measures] and LAW.CONFISC.9 [Execution of provisional measures] may also be refused if the measures sought or any other measures having similar effects would not be permitted under the domestic law of the requesting State, or, as regards the competent authorities of the requesting State, if the request is not authorised by a judicial authority acting in relation to criminal offences.

5. Cooperation under Articles LAW.CONFISC.10 [Obligation to confiscate] to LAW.CONFISC.14 [Imprisonment in default] may also be refused if:

- (a) under the domestic law of the requested State, confiscation is not provided for in respect of the type of offence to which the request relates;
- (b) without prejudice to the obligation pursuant to Article LAW.CONFISC.10(3) [Obligation to confiscate], it would be contrary to the principles of the domestic law of the requested State concerning the limits of confiscation in respect of the relationship between an offence and:
  - (i) an economic advantage that might be qualified as its proceeds; or
  - (ii) property that might be qualified as its instrumentalities;
- (c) under the domestic law of the requested State, confiscation may no longer be imposed or enforced because of the lapse of time;

- (d) without prejudice to Article LAW.CONFISC.10 (5) and (6) [Obligation to confiscate], the request does not relate to a previous conviction, or a decision of a judicial nature or a statement in such a decision that an offence or several offences have been committed, on the basis of which the confiscation has been ordered or is sought;
- (e) confiscation is either not enforceable in the requesting State, or it is still subject to ordinary means of appeal; or
- (f) the request relates to a confiscation order resulting from a decision rendered in absentia of the person against whom the order was issued and, in the opinion of the requested State, the proceedings conducted by the requesting State leading to such decision did not satisfy the minimum rights of defence recognised as due to everyone against whom a criminal charge is made.

6. For the purposes of point (f) of paragraph 5 a decision is not considered to have been rendered in absentia if:

- (a) it has been confirmed or pronounced after opposition by the person concerned; or
- (b) it has been rendered on appeal, provided that the appeal was lodged by the person concerned.

7. When considering, for the purposes of point (f) of paragraph 5, whether the minimum rights of defence have been satisfied, the requested State shall take into account the fact that the person concerned has deliberately sought to evade justice or the fact that that person, having had the possibility of lodging a legal remedy against the decision made in absentia, elected not to do so. The same applies where the person concerned, having been duly served with the summons to appear, elected not to do so nor to ask for adjournment.

8. The States shall not invoke bank secrecy as a ground to refuse any cooperation under this Title. Where its domestic law so requires, a requested State may require that a request for cooperation which would involve the lifting of bank secrecy be authorised by a judicial authority acting in relation to criminal offences.

9. The requested State shall not invoke the fact that:

- (a) the person under investigation or subject to a confiscation order by the authorities of the requesting State is a legal person as an obstacle to affording any cooperation under this Title;
- (b) the natural person against whom an order of confiscation of proceeds has been issued has died or a legal person against whom an order of confiscation of proceeds has been issued has subsequently been dissolved as an obstacle to affording assistance in accordance with point (a) of Article LAW.CONFISC.10(1) [Obligation to confiscate]; or
- (c) the person under investigation or subject to a confiscation order by the authorities of the requesting State is mentioned in the request both as the author of the underlying criminal offence and of the offence of money laundering as an obstacle to affording any cooperation under this Title.

#### Article LAW.CONFISC.16: Consultation and information

Where there are substantial grounds for believing that the execution of a freezing or confiscation order would entail a real risk for the protection of fundamental rights, the requested State shall, before it decides on the execution of the freezing or confiscation order, consult the requesting State and may require any necessary information to be provided.

#### Article LAW.CONFISC.17: Postponement

The requested State may postpone action on a request if such action would prejudice investigations or proceedings by its authorities.

#### Article LAW.CONFISC.18: Partial or conditional granting of a request

Before refusing or postponing cooperation under this Title, the requested State shall, where appropriate after having consulted the requesting State, consider whether the request may be granted partially or subject to such conditions as it deems necessary.

#### Article LAW.CONFISC.19: Notification of documents

1. The States shall afford each other the widest measure of mutual assistance in the serving of judicial documents to persons affected by provisional measures and confiscation.
2. Nothing in this Article is intended to interfere with:
  - (a) the possibility of sending judicial documents, by postal channels, directly to persons abroad; and
  - (b) the possibility for judicial officers, officials or other competent authorities of the State of origin to effect service of judicial documents directly through the consular authorities of that State or through the judicial authorities, including judicial officers and officials, or other competent authorities of the State of destination.
3. When serving judicial documents to persons abroad affected by provisional measures or confiscation orders issued in the sending State, that State shall indicate what legal remedies are available under its domestic law to such persons.

#### Article LAW.CONFISC.20: Recognition of foreign decisions

1. When dealing with a request for cooperation under Articles LAW.CONFISC.8 [Obligation to take provisional measures] to LAW.CONFISC.14 [Imprisonment in default] the requested State shall recognise any decision issued by a judicial authority taken in the requesting State regarding rights claimed by third parties.
2. Recognition may be refused if:
  - (a) third parties did not have adequate opportunity to assert their rights;
  - (b) the decision is incompatible with a decision already taken in the requested State on the same matter;
  - (c) it is incompatible with the *ordre public* of the requested State; or

- (d) the decision was taken contrary to provisions on exclusive jurisdiction provided for by the domestic law of the requested State.

#### Article LAW.CONFISC.21: Authorities

1. Each State shall designate a central authority to be responsible for sending and answering requests made under this Title, the execution of such requests or their transmission to the authorities competent for their execution.
2. The Union may designate a Union body which may, in addition to the competent authorities of the Member States, make and, if appropriate, execute requests under this Title. Any such request is to be treated for the purposes of this Title as a request by a Member State. The Union may also designate that Union body as the central authority responsible for the purpose of sending and answering requests made under this Title by, or to, that body.

#### Article LAW.CONFISC.22: Direct communication

1. The central authorities shall communicate directly with one another.
2. In urgent cases, requests or communications under this Title may be sent directly by the judicial authorities of the requesting State to judicial authorities of the requested State. In such cases, a copy shall be sent at the same time to the central authority of the requested State through the central authority of the requesting State.
3. Where a request is made pursuant to paragraph 2 and the authority is not competent to deal with the request, it shall refer the request to the competent national authority and shall directly inform the requesting State that it has done so.
4. Requests or communications under Articles LAW.CONFISC.3 [Obligation to assist] to LAW.CONFISC.7 [Spontaneous information], which do not involve coercive action, may be directly transmitted by the competent authorities of the requesting State to the competent authorities of the requested State.
5. Draft requests or communications under this Title may be sent directly by the judicial authorities of the requesting State to the judicial authorities of the requested State prior to a formal request to ensure that the formal request can be dealt with efficiently upon receipt and that it contains sufficient information and supporting documentation for it to meet the requirements of the law of the requested State.

#### Article LAW.CONFISC.23: Form of request and languages

1. All requests under this Title shall be made in writing. They may be transmitted electronically, or by any other means of telecommunication, provided that the requesting State is prepared, upon request, to produce a written record of such communication and the original at any time.
2. Requests under paragraph 1 shall be made in one of the official languages of the requested State or in any other language notified by or on behalf of the requested State in accordance with paragraph 3.
3. The United Kingdom and the Union, acting on behalf of any of its Member States, may each notify the Specialised Committee on Law Enforcement and Judicial Cooperation of the language or

languages which, in addition to the official language or languages of that State, may be used for making requests under this Title.

4. Requests under Article LAW.CONFISC.8 [Obligation to take provisional measures] for provisional measures shall be made using the prescribed form at ANNEX LAW-8.

5. Requests under Article LAW.CONFISC.10 [Obligation to confiscate] for confiscation shall be made using the prescribed form at ANNEX LAW-8.

6. The Specialised Committee on Law Enforcement and Judicial Cooperation may amend the forms referred to in paragraphs 4 and 5 as may be necessary.

7. The United Kingdom and the Union, acting on behalf of any of its Member States may each notify the Specialised Committee on Law Enforcement and Judicial Cooperation that it requires the translation of any supporting documents into one of the official languages of the requested State or any other language indicated in accordance with paragraph 3 of this Article. In the case of requests pursuant to Article LAW.CONFISC.8(4) [Obligation to take provisional measures], such translation of supporting documents may be provided to the requested State within 48 hours after transmitting the request, without prejudice to the time limits provided for in Article LAW.CONFISC.8(4) [Obligation to take provisional measures].

#### Article LAW.CONFISC.24: Legalisation

Documents transmitted in application of this Title shall be exempt from all legalisation formalities.

#### Article LAW.CONFISC.25: Content of request

1. Any request for cooperation under this Title shall specify:
  - (a) the authority making the request and the authority carrying out the investigations or proceedings;
  - (b) the object of and the reason for the request;
  - (c) the matters, including the relevant facts (such as date, place and circumstances of the offence) to which the investigations or proceedings relate, except in the case of a request for notification;
  - (d) insofar as the cooperation involves coercive action:
    - (i) the text of the statutory provisions or, where that is not possible, a statement of the relevant applicable law; and
    - (ii) an indication that the measure sought or any other measures having similar effects could be taken in the territory of the requesting State under its own domestic law;
  - (e) where necessary and in so far as possible:
    - (i) details of the person or persons concerned, including name, date and place of birth, nationality and location, and, in the case of a legal person, its seat; and

- (ii) the property in relation to which cooperation is sought, its location, its connection with the person or persons concerned, any connection with the offence, as well as any available information about other persons, interests in the property; and
- (f) any particular procedure the requesting State wishes to be followed.
2. A request for provisional measures under Article LAW.CONFISC.8 [Obligation to take provisional measures] in relation to seizure of property on which a confiscation order consisting of the requirement to pay a sum of money may be realised shall also indicate a maximum amount for which recovery is sought in that property.
3. In addition to the information referred to in paragraph 1 of this Article, any request under Article LAW.CONFISC.10 [Obligation to confiscate] shall contain:
- (a) in the case of point (a) of Article LAW.CONFISC.10(1) [Obligation to confiscate]:
    - (i) a certified true copy of the confiscation order made by the court in the requesting State and a statement of the grounds on the basis of which the order was made, if they are not indicated in the order itself;
    - (ii) an attestation by the competent authority of the requesting State that the confiscation order is enforceable and not subject to ordinary means of appeal;
    - (iii) information as to the extent to which the enforcement of the order is requested; and
    - (iv) information as to the necessity of taking any provisional measures;
  - (b) in the case of point (b) of Article LAW.CONFISC.10(1) [Obligation to confiscate], a statement of the facts relied upon by the requesting State sufficient to enable the requested State to seek the order under its domestic law;
  - (c) where third parties have had the opportunity to claim rights, documents demonstrating that this has been the case.

#### Article LAW.CONFISC.26: Defective requests

1. If a request does not comply with the provisions of this Title or the information supplied is not sufficient to enable the requested State to deal with the request, that State may ask the requesting State to amend the request or to complete it with additional information.
2. The requested State may set a time limit for the receipt of such amendments or information.
3. Pending receipt of the requested amendments or information in relation to a request under Article LAW.CONFISC.10 [Obligation to confiscate], the requested State may take any of the measures referred to in Articles LAW.CONFISC.3 [Obligation to assist] to LAW.CONFISC.9 [Execution of provisional measures].

#### Article LAW.CONFISC.27: Plurality of requests

1. Where the requested State receives more than one request under Article LAW.CONFISC.8 [Obligation to take provisional measures] or Article LAW.CONFISC.10 [Obligation to confiscate] in



respect of the same person or property, the plurality of requests shall not prevent that State from dealing with the requests involving the taking of provisional measures.

2. In the case of a plurality of requests under Article LAW.CONFISC.10 [Obligation to confiscate], the requested State shall consider consulting the requesting States.

#### Article LAW.CONFISC.28: Obligation to give reasons

The requested State shall give reasons for any decision to refuse, postpone or make conditional any cooperation under this Title.

#### Article LAW.CONFISC.29: Information

1. The requested State shall promptly inform the requesting State of:
  - (a) the action initiated on the basis of a request under this Title;
  - (b) the final result of the action carried out on the basis of a request under this Title;
  - (c) a decision to refuse, postpone or make conditional, in whole or in part, any cooperation under this Title;
  - (d) any circumstances which render impossible the carrying out of the action sought or are likely to delay it significantly; and
  - (e) in the event of provisional measures taken pursuant to a request under Articles LAW.CONFISC.3 [Obligation to assist] to Article LAW.CONFISC.8 [Obligation to take provisional measures], such provisions of its domestic law as would automatically lead to the lifting of the provisional measure.
2. The requesting State shall promptly inform the requested State of:
  - (a) any review, decision or any other fact by reason of which the confiscation order ceases to be wholly or partially enforceable; and
  - (b) any development, factual or legal, by reason of which any action under this Title is no longer justified.
3. Where a State, on the basis of the same confiscation order, requests confiscation in more than one State, it shall inform all States which are affected by the enforcement of the order about the request.

#### Article LAW.CONFISC.30: Restriction of use

1. The requested State may make the execution of a request dependent on the condition that the information or evidence obtained is not, without its prior consent, to be used or transmitted by the authorities of the requesting State for investigations or proceedings other than those specified in the request.
2. Without the prior consent of the requested State, information or evidence provided by it under this Title shall not be used or transmitted by the authorities of the requesting State in investigations or proceedings other than those specified in the request.



3. Personal data communicated under this Title may be used by the State to which they have been transferred:

- (a) for the purposes of proceedings to which this Title applies;
- (b) for other judicial and administrative proceedings directly related to proceedings referred to under point (a);
- (c) for preventing an immediate and serious threat to public security; or
- (d) for any other purpose, only with the prior consent of the communicating State, unless the State concerned has obtained the consent of the data subject.

4. This Article shall also apply to personal data not communicated but obtained otherwise under this Title.

5. This Article does not apply to personal data obtained by the United Kingdom or a Member State under this Title and originating from that State.

#### Article LAW.CONFISC.31: Confidentiality

1. The requesting State may require that the requested State keep confidential the facts and substance of the request, except to the extent necessary to execute the request. If the requested State cannot comply with the requirement of confidentiality, it shall promptly inform the requesting State.

2. The requesting State shall, if not contrary to basic principles of its domestic law and if so requested, keep confidential any evidence and information provided by the requested State, except to the extent that its disclosure is necessary for the investigations or proceedings described in the request.

3. Subject to the provisions of its domestic law, a State which has received spontaneous information under Article LAW.CONFISC.7 [Spontaneous information] shall comply with any requirement of confidentiality as required by the State which supplies the information. If the receiving State cannot comply with such a requirement, it shall promptly inform the transmitting State.

#### Article LAW.CONFISC.32: Costs

The ordinary costs of complying with a request shall be borne by the requested State. Where costs of a substantial or extraordinary nature are necessary to comply with a request, the requesting and requested States shall consult in order to agree the conditions on which the request is to be executed and how the costs will be borne.

#### Article LAW.CONFISC.33: Damages

1. Where legal action on liability for damages resulting from an act or omission in relation to cooperation under this Title has been initiated by a person, the States concerned shall consider consulting each other, where appropriate, to determine how to apportion any sum of damages due.

2. A State which has become the subject of litigation for damages shall endeavour to inform the other State of such litigation if that State might have an interest in the case.

#### Article LAW.CONFISC.34: Legal remedies

1. Each State shall ensure that persons affected by measures under Articles LAW.CONFISC.8 [Obligation to take provisional measures] to LAW.CONFISC.11 [Execution of confiscation] have effective legal remedies in order to preserve their rights.
2. The substantive reasons for requested measures under Articles LAW.CONFISC.8 [Obligation to take provisional measures] to LAW.CONFISC.11 [Execution of confiscation] shall not be challenged before a court in the requested State.

#### *TITLE XII: OTHER PROVISIONS*

#### Article LAW.OTHER.134: Notifications

1. By the date of entry into force of this Agreement, the Union and the United Kingdom shall make any of the notifications provided for in Article LAW.SURR.82(2) [Political offence exception], Article LAW.SURR.83(2) [Nationality exception], and Article LAW.SURR.91(4) [Consent to surrender] and shall, to the extent it is possible to do so, indicate whether no such notification is to be made.

To the extent that such a notification or indication has not been made in relation to a State, at the point in time referred to in the first subparagraph, notifications may be made in relation to that State as soon as possible and at the latest two months after the entry into force of this Agreement.

During that interim period, any State in relation to which no notification provided for in Article LAW.SURR.82(2) [Political offence exception], Article LAW.SURR.83(2) [Nationality exception], or Article LAW.SURR.91(4) [Consent to surrender] has been made, and which has not been the subject of an indication that no such notification is to be made, may avail itself of the possibilities provided for in that Article as if such a notification had been made in respect of that State. In the case of Article LAW.SURR.83(2) [Nationality exception], a State may only avail itself of the possibilities provided for in that Article to the extent that to do so is compatible with the criteria for making a notification.

2. The notifications referred to in Article LAW.SURR.79(4) [Scope], Article LAW.SURR.85(1) [Recourse to the central authority], Article LAW.SURR.86(2) [Content and form of the arrest warrant], Article LAW.SURR.105(1) [Possible prosecution for other offences], Article LAW.SURR.106(1) [Surrender or subsequent extradition], Article LAW.CONFISC.4(4) [Requests for information on bank accounts and safe deposit boxes], Article LAW.CONFISC.5(5) [Requests for information on banking transactions], Article LAW.CONFISC.6(5) [Requests for the monitoring of banking transactions], Article LAW.CONFISC.15(2) [Grounds for refusal], and Article LAW.CONFISC.23(3) and (7) [Form of request and languages] may be made at any time.
3. The notifications referred to in Article LAW.SURR.85(1) [Recourse to the central authority], Article LAW.SURR.86(2) [Content and form of the arrest warrant] and Article LAW.CONFISC.23(3) and (7) [Form of request and languages] may be modified at any time.
4. The notifications referred to in Article LAW.SURR.82(2) [Political offence exception], Article LAW.SURR.83(2) [Nationality exception], Article LAW.SURR.85(1) [Recourse to the central authority], Article LAW.SURR.91(4) [Consent to surrender], Article LAW.CONFISC.4(4) [Requests for information on bank accounts and safe deposit boxes], Article LAW.CONFISC.5(5) [Requests for

information on banking transactions], and Article LAW.CONFISC.6(5) [Requests for the monitoring of banking transactions] may be withdrawn at any time.

5. The Union shall publish information on notifications of the United Kingdom referred to in Article LAW.SURR.85(1) [Recourse to the central authority] in the Official Journal of the European Union.

6. By the date of entry into force of this Agreement, the United Kingdom shall notify the Union of the identity of the following authorities:

- (a) the authority responsible for receiving and processing PNR data under Title III [Transfer and processing of passenger name record data (PNR)];
- (b) the authority considered as the competent law enforcement authority for the purposes of Title V [Cooperation with Europol] and a short description of its competences;
- (c) the national contact point designated under Article LAW.EUROPOL.50(1) [National contact point and liaison officers];
- (d) the authority considered as the competent authority for the purposes of Title VI [Cooperation with Eurojust] and a short description of its competences;
- (e) the contact point designated under Article LAW.EUROJUST.65(1) [Contact points to Eurojust];
- (f) the United Kingdom Domestic Correspondent for Terrorism Matters designated under Article LAW.EUROJUST.65(2) [Contact points to Eurojust];
- (g) the authority competent by virtue of domestic law of the United Kingdom to execute an arrest warrant, as referred to in point (c) of Article LAW.SURR.78 [Definitions], and the authority competent by virtue of the domestic law of the United Kingdom to issue an arrest warrant, as referred to in point (d) of Article LAW.SURR.78 [Definitions];
- (h) the authority designated by the United Kingdom under Article LAW.SURR.103(3) [Transit];
- (i) the central authority designated by the United Kingdom under Article LAW.EXINF.122 [Central authorities];
- (j) the central authority designated by the United Kingdom under Article LAW.CONFISC.21(1) [Authorities].

The Union shall publish information about the authorities referred to in the first subparagraph in the Official Journal of the European Union.

7. By the date of entry into force of this Agreement, the Union shall, on its behalf or on behalf of its Member States as the case may be, notify the United Kingdom, of the identity of the following authorities:

- (a) the Passenger Information Units established or designated by each Member State for the purposes of receiving and processing PNR data under Title III [Transfer and processing of passenger name record data (PNR)];

- (b) the authority competent by virtue of the domestic law of each Member State to execute an arrest warrant, as referred to in point (c) of Article LAW.SURR.78 [Definitions], and the authority competent by virtue of the domestic law of each Member State to issue an arrest warrant, as referred to in point (d) of Article LAW.SURR.78 [Definitions];
  - (c) the authority designated for each Member State under Article LAW.SURR.103(3) [Transit];
  - (d) the Union body referred to in Article LAW.MUTAS.114 [Definition of competent authority];
  - (e) the central authority designated by each Member State under Article LAW.EXINF.122 [Central authorities];
  - (f) the central authority designated by each Member State under Article LAW.CONFISC.21(1) [Authorities];
  - (g) any Union body designated under the first sentence of Article LAW.CONFISC.21(2) [Authorities] and whether it is also designated as a central authority under the last sentence of that paragraph.
8. The notifications made under paragraph 6 or 7 may be modified at any time. Such modifications shall be notified to the Specialised Committee on Law Enforcement and Judicial Cooperation.
9. The United Kingdom and the Union may notify more than one authority with respect to points (a), (b), (d), (e), (g), (h), (i) and (j) of paragraph 6 and with respect to paragraph 7 respectively and may limit such notifications for particular purposes only.
10. Where the Union makes the notifications referred to in this Article, it shall indicate to which of its Member States the notification applies or whether it is making the notification on its own behalf.

#### Article LAW.OTHER.135: Review and evaluation

1. This Part shall be jointly reviewed in accordance with Article FINPROV.3 [Review] or at the request of either Party where jointly agreed.
2. The Parties shall decide in advance on how the review is to be conducted and shall communicate to each other the composition of their respective review teams. The review teams shall include persons with appropriate expertise with respect to the issues under review. Subject to applicable laws, all participants in a review shall be required to respect the confidentiality of the discussions and to have appropriate security clearances. For the purposes of such reviews, the United Kingdom and the Union shall make arrangements for appropriate access to relevant documentation, systems and personnel.
3. Without prejudice to paragraph 2, the review shall in particular address the practical implementation, interpretation and development of this Part.

#### Article LAW.OTHER.136: Termination

1. Without prejudice to Article FINPROV.8 [Termination], each Party may at any moment terminate this Part by written notification through diplomatic channels. In that event, this Part shall cease to be in force on the first day of the ninth month following the date of notification.

2. However, if this Part is terminated on account of the United Kingdom or a Member State having denounced the European Convention on Human Rights or Protocols 1, 6 or 13 thereto, this Part shall cease to be in force as of the date that such denunciation becomes effective or, if the notification of its termination is made after that date, on the fifteenth day following such notification.

3. If either Party gives notice of termination under this Article, the Specialised Committee on Law Enforcement and Judicial Cooperation shall meet to decide what measures are needed to ensure that any cooperation initiated under this Part is concluded in an appropriate manner. In any event, with regard to all personal data obtained through cooperation under this Part before it ceases to be in force, the Parties shall ensure that the level of protection under which the personal data were transferred is maintained after the termination takes effect.

#### Article LAW.OTHER.137: Suspension

1. In the event of serious and systemic deficiencies within one Party as regards the protection of fundamental rights or the principle of the rule of law, the other Party may suspend this Part or Titles thereof, by written notification through diplomatic channels. Such notification shall specify the serious and systemic deficiencies on which the suspension is based.

2. In the event of serious and systemic deficiencies within one Party as regards the protection of personal data, including where those deficiencies have led to a relevant adequacy decision ceasing to apply, the other Party may suspend this Part or Titles thereof, by written notification through diplomatic channels. Such notification shall specify the serious and systemic deficiencies on which the suspension is based.

3. For the purposes of paragraph 2, “relevant adequacy decision” means:

- (a) in relation to the United Kingdom, a decision adopted by the European Commission, in accordance with Article 36 of Directive (EU) 2016/680<sup>82</sup> or analogous successor legislation, attesting to the adequate level of protection;
- (b) in relation to the Union, a decision adopted by the United Kingdom attesting to the adequate level of protection for the purposes of transfers falling within the scope of Part 3 of the Data Protection Act 2018<sup>83</sup> or analogous successor legislation.

4. In relation to the suspension of Title III [Transfer and processing of passenger name record data (PNR)] or Title X [Anti-money laundering and counter terrorist financing], references to a “relevant adequacy decision” also include:

---

<sup>82</sup> Directive (EU) 2016/680 of the European Parliament and of the Council of 27 April 2016 on the protection of natural persons with regard to the processing of personal data by competent authorities for the purposes of the prevention, investigation, detection or prosecution of criminal offences or the execution of criminal penalties, and on the free movement of such data, and repealing Council Framework Decision 2008/977/JHA (OJ EU L 119, 4.5.2016, p. 89).

<sup>83</sup> 2018 chapter 12.

- (a) in relation to the United Kingdom, a decision adopted by the European Commission, in accordance with Article 45 of the General Data Protection Regulation (EU) 2016/679<sup>84</sup> or analogous successor legislation attesting to the adequate level of protection;
- (b) in relation to the Union, a decision adopted by the United Kingdom attesting to the adequate level of protection for the purposes of transfers falling within the scope of Part 2 of the Data Protection Act 2018 or analogous successor legislation.

5. The Titles concerned by the suspension shall provisionally cease to apply on the first day of the third month following the date of the notification referred to in paragraph 1 or 2, unless, no later than two weeks before the expiry of that period, as extended, as the case may be, in accordance with point (d) of paragraph 7, the Party which notified the suspension gives written notification to the other Party, through diplomatic channels, of its withdrawal of the first notification or of a reduction in scope of the suspension. In the latter case, only the Titles referred to in the second notification shall provisionally cease to apply.

6. If one Party notifies the suspension of one or several Titles of this Part pursuant to paragraph 1 or 2, the other Party may suspend all of the remaining Titles, by written notification through diplomatic channels, with three months' notice.

7. Upon the notification of a suspension pursuant to paragraph 1 or 2, the Partnership Council shall immediately be seized of the matter. The Partnership Council shall explore possible ways of allowing the Party that notified the suspension to postpone its entry into effect, to reduce its scope or to withdraw it. To that end, upon a recommendation of the Specialised Committee on Law Enforcement and Judicial Cooperation, the Partnership Council may:

- (a) agree on joint interpretations of provisions of this Part;
- (b) recommend any appropriate action to the Parties;
- (c) adopt appropriate adaptations to this Part which are necessary to address the reasons underlying the suspension, with a maximum validity of 12 months; and
- (d) extend the period referred to in paragraph 5 by up to three months.

8. If either Party gives notification of suspension under this Article, the Specialised Committee on Law Enforcement and Judicial Cooperation shall meet to decide what measures are needed to ensure that any cooperation initiated under this Part and affected by the notification is concluded in an appropriate manner. In any event, with regard to all personal data obtained through cooperation under this Part before the Titles concerned by the suspension provisionally cease to apply, the Parties shall ensure that the level of protection under which the personal data were transferred is maintained after the suspension takes effect.

9. The suspended Titles shall be reinstated on the first day of the month following the day on which the Party having notified the suspension pursuant to paragraph 1 or 2 has given written

---

<sup>84</sup> Regulation (EU) 2016/679 of the European Parliament and of the Council of 27 April 2016 on the protection of natural persons with regard to the processing of personal data and on the free movement of such data, and repealing Directive 95/46/EC (General Data Protection Regulation) (Text with EEA relevance) (OJ EU L 119, 4.5.2016, p. 1).

notification to the other Party, through diplomatic channels, of its intention to reinstate the suspended Titles. The Party having notified the suspension pursuant to paragraph 1 or 2 shall do so immediately after the serious and systemic deficiencies on the part of the other Party on which the suspension was based have ceased to exist.

10. Upon the notification of the intention to reinstate the suspended Titles in accordance with paragraph 9, the remaining Titles suspended pursuant to paragraph 6 shall be reinstated at the same time as the Titles suspended pursuant to paragraph 1 or 2.

#### Article LAW.OTHER.138: Expenses

The Parties and the Member States, including institutions, bodies, offices and agencies of the Parties or the Member States, shall bear their own expenses which arise in the course of implementation of this Part, unless otherwise provided for in this Agreement.

### *TITLE XIII: DISPUTE SETTLEMENT*

#### Article LAW.DS.1: Objective

The objective of this Title is to establish a swift, effective and efficient mechanism for avoiding and settling disputes between the Parties concerning this Part, including disputes concerning this Part when applied to situations governed by other provisions of this Agreement, with a view to reaching a mutually agreed solution, where possible.

#### Article LAW.DS.2: Scope

1. This Title applies to disputes between the Parties concerning this Part (the “covered provisions”).
2. The covered provisions shall include all provisions of this Part, with the exception of:
  - (a) Article LAW.GEN.5 [Scope for cooperation where a Member State no longer participates in analogous measures under Union law];
  - (b) Article LAW.PRUM.19 [Suspension and disapplication];
  - (c) Article LAW.PNR.28(14) [Retention of PNR data];
  - (d) Article LAW.PNR.38 [Suspension of cooperation under this Title];
  - (e) Article LAW.OTHER.136 [Termination];
  - (f) Article LAW.OTHER.137 [Suspension]; and
  - (g) Article LAW.DS.6 [Suspension].

#### Article LAW.DS.3: Exclusivity

The Parties undertake not to submit a dispute between them regarding this Part to a mechanism of settlement other than that provided for in this Title.



#### Article LAW.DS.4: Consultations

1. If a Party (“the complaining Party”) considers that the other Party (“the responding Party”) has breached an obligation under this Part, the Parties shall endeavour to resolve the matter by entering into consultations in good faith, with the aim of reaching a mutually agreed solution.
2. The complaining Party may seek consultations by means of a written request delivered to the responding Party. The complaining Party shall specify in its written request the reasons for the request, including identification of the acts or omissions that the complaining Party considers as giving rise to the breach of an obligation by the responding Party, specifying the covered provisions it considers applicable.
3. The responding Party shall reply to the request promptly, and no later than two weeks after the date of its delivery. Consultations shall be held regularly within a period of three months following the date of delivery of the request in person or by any other means of communication agreed by the Parties.
4. The consultations shall be concluded within three months of the date of delivery of the request, unless the Parties agree to continue the consultations.
5. The complaining Party may request that the consultations be held in the framework of the Specialised Committee on Law Enforcement and Judicial Cooperation or in the framework of the Partnership Council. The first meeting shall take place within one month of the request for consultations referred to in paragraph 2 of this Article. The Specialised Committee on Law Enforcement and Judicial Cooperation may at any time decide to refer the matter to the Partnership Council. The Partnership Council may also seize itself of the matter. The Specialised Committee on Law Enforcement and Judicial Cooperation, or as the case may be, the Partnership Council, may resolve the dispute by a decision. Such a decision shall be considered a mutually agreed solution within the meaning of Article LAW.DS.5 [Mutually agreed solution].
6. The complaining Party may at any time unilaterally withdraw its request for consultations. In such a case, the consultations shall be terminated immediately.
7. Consultations, and in particular all information designated as confidential and positions taken by the Parties during consultations, shall be confidential.

#### Article LAW.DS.5: Mutually agreed solution

1. The Parties may at any time reach a mutually agreed solution with respect to any dispute referred to in Article LAW.DS.2 [Scope].
2. The mutually agreed solution may be adopted by means of a decision of the Specialised Committee on Law Enforcement and Judicial Cooperation or the Partnership Council. Where the mutually agreed solution consists of an agreement on joint interpretations of provisions of this Part by the Parties, that mutually agreed solution shall be adopted by means of a decision of the Partnership Council.
3. Each Party shall take the measures necessary to implement the mutually agreed solution within the agreed time period.
4. No later than the date of expiry of the agreed time period, the implementing Party shall inform the other Party in writing of any measures taken to implement the mutually agreed solution.



## Article LAW.DS.6: Suspension

1. Where consultations under Article LAW.DS.4 [Consultations] have not led to a mutually agreed solution within the meaning of Article LAW.DS.5 [Mutually agreed solution], provided that the complaining Party has not withdrawn its request for consultations in accordance with Article LAW.DS.4(6) [Consultations], and where it considers that the respondent Party is in serious breach of its obligations under the covered provisions referred to in Article LAW.DS.4(2) [Consultations], the complaining Party may suspend the Titles of this Part to which the serious breach pertains, by written notification through diplomatic channels. Such notification shall specify the serious breach of obligations by the responding Party on which the suspension is based.
2. The Titles concerned by the suspension shall provisionally cease to apply on the first day of the third month following the date of the notification referred to in paragraph 1 or any other date mutually agreed by the Parties, unless, no later than two weeks before the expiry of that period, the complaining Party gives written notification to the responding Party, through diplomatic channels, of its withdrawal of the first notification or of a reduction in scope of the suspension. In the latter case, only the Titles referred to in the second notification shall provisionally cease to apply.
3. If the complaining Party notifies the suspension of one or several Titles of this Part pursuant to paragraph 1, the respondent Party may suspend all of the remaining Titles, by written notification through diplomatic channels, with three months' notice.
4. If a notification of suspension is given under this Article, the Specialised Committee on Law Enforcement and Judicial Cooperation shall meet to decide what measures are needed to ensure that any cooperation initiated under this Part and affected by the notification is concluded in an appropriate manner. In any event, with regard to all personal data obtained through cooperation under this Part before the Titles concerned by the suspension provisionally cease to apply, the Parties shall ensure that the level of protection under which the personal data were transferred is maintained after the suspension takes effect.
5. The suspended Titles shall be reinstated on the first day of the month following the date on which the complaining Party has given written notification to the respondent Party, through diplomatic channels, of its intention to reinstate the suspended Titles. The complaining Party shall do so immediately when it considers that the serious breach of the obligations on which the suspension was based has ceased to exist.
6. Upon notification by the complaining Party of its intention to reinstate the suspended Titles in accordance with paragraph 5, the remaining Titles suspended by the respondent Party pursuant to paragraph 3 shall be reinstated at the same time as the Titles suspended by the complaining Party pursuant to paragraph 1.

## Article LAW.DS.7: Time Periods

1. All time periods laid down in this Title shall be counted in weeks or months, as the case may be, from the day following the act to which they refer.
2. Any time period referred to in this Title may be modified by mutual agreement of the Parties.

## **PART FOUR: THEMATIC COOPERATION**

### *TITLE I: HEALTH SECURITY*

#### Article HS.1: Cooperation on health security

1. For the purpose of this Article, a “serious cross-border threat to health” means a life-threatening or otherwise serious hazard to health of biological, chemical, environmental or unknown origin which spreads or entails a significant risk of spreading across the borders of at least one Member State and the United Kingdom.
2. The Parties shall inform each other of a serious cross-border threat to health affecting the other Party and shall endeavour to do so in a timely manner.
3. Where there is a serious cross-border threat to health, following a written request from the United Kingdom, the Union may grant the United Kingdom ad hoc access to its Early Warning and Response System (the “EWRS”) in respect of the particular threat to enable the Parties and Member States’ competent authorities to exchange relevant information, to assess public health risks, and to coordinate the measures that could be required to protect public health. The Union shall endeavour to respond to the United Kingdom’s written request in a timely manner.

Moreover, the Union may invite the United Kingdom to participate in a committee established within the Union and composed of representatives of Member States for the purposes of supporting the exchange of information and of coordination in relation to the serious cross-border threat to health.

Both arrangements shall be on a temporary basis, and in any event for no longer than the duration that either of the Parties, having consulted the other Party, considers necessary for the relevant serious cross-border threat to health.

4. For the purposes of the information exchange referred to in paragraph 2 and any requests made pursuant to paragraph 3, each Party shall designate a focal point and notify the other Party thereof. The focal points shall also:
  - (a) endeavour to facilitate understanding between the Parties as to whether or not a threat is a serious cross-border threat to health;
  - (b) seek mutually agreed solutions to any technical issues arising from implementation of this Title.
5. The United Kingdom shall observe all applicable conditions for the use of the EWRS and the rules of procedure of the committee referred to in paragraph 3, for the period of access granted in respect of a particular serious cross-border threat to health. If, following clarificatory exchanges between the Parties:
  - (a) the Union considers that the United Kingdom has not observed the above-mentioned conditions or rules of procedure, the Union may terminate the access of the United Kingdom

to the EWRS or its participation in that committee, as the case may be, in respect of that threat;

- (b) the United Kingdom considers that it cannot accept the conditions or rules of procedure, the United Kingdom may withdraw its participation in the EWRS or its participation in that committee, as the case may be, in respect of that threat.

6. Where in their mutual interests the Parties shall cooperate in international forums on the prevention of, detection of, preparation for, and response to established and emerging threats to health security.

7. The European Centre for Disease Prevention and Control and the relevant body in the United Kingdom responsible for surveillance, epidemic intelligence and scientific advice on infectious diseases shall cooperate on technical and scientific matters of mutual interest to the Parties and, to that end, may conclude a memorandum of understanding.

## *TITLE II: CYBER SECURITY*

### Article CYB.1: Dialogue on cyber issues

The Parties shall endeavour to establish a regular dialogue in order to exchange information about relevant policy developments, including in relation to international security, security of emerging technologies, internet governance, cybersecurity, cyber defence and cybercrime.

### Article CYB.2: Cooperation on cyber issues

1. Where in their mutual interest, the Parties shall cooperate in the field of cyber issues by sharing best practices and through cooperative practical actions aimed at promoting and protecting an open, free, stable, peaceful and secure cyberspace based on the application of existing international law and norms for responsible State behaviour and regional cyber confidence-building measures.

2. The Parties shall also endeavour to cooperate in relevant international bodies and forums, and endeavour to strengthen global cyber resilience and enhance the ability of third countries to fight cybercrime effectively.

### Article CYB.3: Cooperation with the Computer Emergency Response Team – European Union

Subject to prior approval by the Steering Board of the Computer Emergency Response Team – European Union (CERT-EU), CERT-EU and the national UK computer emergency response team shall cooperate on a voluntary, timely and reciprocal basis to exchange information on tools and methods, such as techniques, tactics, procedures and best practices, and on general threats and vulnerabilities.

Article CYB.4: Participation in specific activities of the Cooperation Group established pursuant to Directive (EU) 2016/1148

1. With a view to promoting cooperation on cyber security while ensuring the autonomy of the Union decision-making process, the relevant national authorities of the United Kingdom may participate at the invitation, which the United Kingdom may also request, of the Chair of the Cooperation Group in consultation with the Commission, in the following activities of the Cooperation Group:

- (a) exchanging best practices in building capacity to ensure the security of network and information systems;
- (b) exchanging information with regard to exercises relating to the security of network and information systems;
- (c) exchanging information, experiences and best practices on risks and incidents;
- (d) exchanging information and best practices on awareness-raising, education programmes and training; and
- (e) exchanging information and best practices on research and development relating to the security of network and information systems.

2. Any exchange of information, experiences or best practices between the Cooperation Group and the relevant national authorities of the United Kingdom shall be voluntary and, where appropriate, reciprocal.

Article CYB.5: Cooperation with the EU Agency for Cybersecurity (ENISA)

1. With a view to promoting cooperation on cyber security while ensuring the autonomy of the Union decision-making process, the United Kingdom may participate at the invitation, which the United Kingdom may also request, of the Management Board of the EU Cybersecurity Agency (ENISA), in the following activities carried out by ENISA:

- (a) capacity building;
- (b) knowledge and information; and
- (c) awareness raising and education.

2. The conditions for the participation of the United Kingdom in ENISA's activities referred to in paragraph 1, including an appropriate financial contribution, shall be set out in working arrangements adopted by the Management Board of ENISA subject to prior approval by the Commission and agreed with the United Kingdom.

3. The exchange of information, experiences and best practices between ENISA and the United Kingdom shall be voluntary and, where appropriate, reciprocal.



## **PART FIVE: PARTICIPATION IN UNION PROGRAMMES, SOUND FINANCIAL MANAGEMENT AND FINANCIAL PROVISIONS**

### Article UNPRO.0.1: Scope

1. This Part shall apply to the participation of the United Kingdom in Union programmes, activities and services thereunder, in which the Parties have agreed that the United Kingdom participates.
2. This Part shall not apply to the participation of the United Kingdom in cohesion programmes under the European territorial cooperation goal or similar programmes having the same objective, which takes place on the basis of the basic acts of one or more Union institutions applicable to those programmes.

The applicable conditions for participation in the programmes referred to in the first subparagraph shall be specified in the applicable basic act and the financing agreement concluded thereunder. The Parties shall agree provisions with similar effect to Chapter Two [Sound Financial Management] concerning the participation of the United Kingdom in those programmes.

### Article UNPRO.0.2: Definitions

For the purposes of this Part, the following definitions apply:

- (a) "basic act" means:
  - (i) an act of one or more Union institutions establishing a programme or activity, which provides a legal basis for an action and for the implementation of the corresponding expenditure entered in the Union budget or of the budgetary guarantee backed by the Union budget, including any amendment and including any relevant acts of a Union institution which supplement or implement that act, except those adopting work programmes; or
  - (ii) an act of one or more Union institutions establishing an activity financed from the Union budget other than programmes;
- (b) "funding agreement" means agreements relating to Union programmes and activities under Protocol I which implement Union funds, such as grant agreements, contribution agreements, financial framework partnership agreements, financing agreements and guarantee agreements.
- (c) "other rules pertaining to the implementation of the Union programme and activity" means rules laid down in the Regulation (EU, Euratom) 2018/1046 of the European Parliament and of the Council<sup>85</sup> ('Financial Regulation') that apply to the general budget of the Union, and in the work programme or in the calls or other Union award procedures;

---

<sup>85</sup> Regulation (EU, Euratom) 2018/1046 of the European Parliament and of the Council of 18 July 2018 on the financial rules applicable to the general budget of the Union, amending Regulations (EU) No 1296/2013, (EU) No 1301/2013, (EU) No 1303/2013, (EU) No 1304/2013, (EU) No 1309/2013, (EU) No 1316/2013, (EU) No 223/2014, (EU) No 283/2014, and Decision No 541/2014/EU and repealing Regulation (EU, Euratom) No 966/2012 (OJ EU L 193, 30.7.2018, p. 1).

- (d) "Union" means the Union or the European Atomic Energy Community, or both, as the context may require;
- (e) "Union award procedure" means a procedure for award of Union funding launched by the Union or by persons or entities entrusted with the implementation of Union funds;
- (f) "United Kingdom entity" means any type of entity, whether a natural person, legal person or another type of entity, which may participate in activities of a Union programme or activity in accordance with the basic act and who resides or which is established in the United Kingdom.

## Chapter 1: Participation of the United Kingdom in Union programmes and activities

### *Section 1: General conditions for participation in Union programmes and activities*

#### Article UNPRO.1.3: Establishment of the participation

1. The United Kingdom shall participate in and contribute to the Union programmes, activities, or in exceptional cases, the part of Union programmes or activities, which are open to its participation, and which are listed in Protocol I [Programmes and activities in which the United Kingdom participates].
2. Protocol I shall be agreed between the Parties. It shall be adopted and may be amended by the Specialised Committee on Participation in Union Programmes.
3. Protocol I shall:
  - (a) identify the Union programmes, activities, or in exceptional cases, the part of Union programmes or activities, in which the United Kingdom shall participate;
  - (b) lay down the duration of participation, which shall refer to the period of time during which the United Kingdom and United Kingdom entities may apply for Union funding or may be entrusted with implementation of Union funds;
  - (c) lay down specific conditions for the participation of the United Kingdom and United Kingdom entities, including specific modalities for the implementation of the financial conditions as identified under Article UNPRO.2.1 [Financial conditions], specific modalities of the correction mechanism as identified under Article UNPRO.2.2 [Programmes where an automatic correction mechanism may apply], and conditions for participation in structures created for the purposes of implementing those Union programmes or activities. These conditions shall comply with this Agreement and the basic acts and acts of one or more Union institutions establishing such structures;
  - (d) where applicable, lay down the amount of United Kingdom's contribution to a Union programme implemented through a financial instrument or a budgetary guarantee and, where appropriate, specific modalities referred to in Article UNPRO.2.3 [Financing in relation to programmes implemented through financial instruments or budgetary guarantees].

#### Article UNPRO.1.4: Compliance with programme rules

1. The United Kingdom shall participate in the Union programmes, activities or parts thereof listed in Protocol I under the terms and conditions established in this Agreement, in the basic acts and other rules pertaining to the implementation of Union programmes and activities.

2. The terms and conditions referred to in paragraph 1 shall include:
  - (a) the eligibility of the United Kingdom entities and any other eligibility conditions related to the United Kingdom, in particular to the origin, place of activity or nationality;
  - (b) the terms and conditions applicable to the submission, assessment and selection of applications and to the implementation of the actions by eligible United Kingdom entities.
3. The terms and conditions referred to in point (b) of paragraph 2 shall be equivalent to those applicable to eligible Member States entities, except in duly justified exceptional cases as provided for in the terms and conditions referred to in paragraph 1. Either party may bring to the attention of the Specialised Committee on Participation in Union Programmes the need for a discussion of duly justified exclusions.

#### Article UNPRO.1.5: Conditions for participation

1. The United Kingdom's participation in a Union programme or activity, or parts thereof as referred to in Article UNPRO.0.1 [Scope] shall be conditional upon the United Kingdom:
  - (a) making every effort, within the framework of its domestic laws, to facilitate the entry and residence of persons involved in the implementation of these programmes and activities, or parts thereof, including students, researchers, trainees or volunteers;
  - (b) ensuring, as far as it is under the control of the United Kingdom authorities, that the conditions for the persons referred to in point (a) to access services in the United Kingdom that are directly related to the implementation of the programmes or activities are the same as for United Kingdom nationals, including as regards any fees;
  - (c) as regards participation involving exchange of or access to classified or sensitive non-classified information, having in place the appropriate agreements in accordance with Article FINPROV.6 [Classified information and sensitive non-classified information].
2. In relation to the United Kingdom's participation in a Union programme or activity, or parts thereof as referred to in Article UNPRO.0.1 [Scope] the Union and its Member States shall:
  - (a) make every effort, within the framework of Union or the Member States' legislation, to facilitate the entry and residence of United Kingdom nationals involved in the implementation of these programmes and activities, or parts thereof, including students, researchers, trainees or volunteers;
  - (b) ensure, as far as it is under the control of the Union and Member States' authorities, that the conditions for the United Kingdom nationals referred to in point (a) to access services in the Union that are directly related to the implementation of the programmes or activities are the same as for Union citizens, including as regards any fees.
3. Protocol I may lay down further specific conditions referring to this Article, which are necessary for the participation of the United Kingdom in a Union programme or activity, or parts thereof.
4. This Article is without prejudice to Article UNPRO.1.4 [Compliance with programme rules].



5. This Article and Article UNPRO.3.1 [Suspension of the participation of the UK in a Union programme by the Union], are also without prejudice to any arrangements made between the United Kingdom and Ireland concerning the Common Travel Area.

Article UNPRO.1.6: Participation of the United Kingdom in the governance of programmes or activities

1. Representatives or experts of the United Kingdom or experts designated by the United Kingdom shall be allowed to take part, as observers unless it concerns points reserved only for Member States or in relation to a programme or activity in which the United Kingdom is not participating, in the committees, expert groups meetings or other similar meetings where representatives or experts of the Member States, or experts designated by Member States take part, and which assist the European Commission in the implementation and management of the programmes, the activities or parts thereof, in which the United Kingdom participates in accordance with Article UNPRO.0.1 [Scope] or are established by the European Commission in respect of the implementation of the Union law in relation to these programmes, activities or parts thereof. The representatives or experts of the United Kingdom, or experts designated by the United Kingdom shall not be present at the time of voting. The United Kingdom shall be informed of the result of the vote.

2. Where experts or evaluators are not appointed on the basis of nationality, nationality shall not be a reason to exclude United Kingdom nationals.

3. Subject to the conditions of paragraph 1, participation of the United Kingdom's representatives in the meetings referred to in paragraph 1, or in other meetings related to the implementation of programmes or activities, shall be governed by the same rules and procedures as those applicable to representatives of the Member States, in particular speaking rights, receipt of information and documentation unless it concerns points reserved only for Member States or in relation to a programme or activity in which the United Kingdom is not participating, and the reimbursement of travel and subsistence costs.

4. Protocol I may define further modalities for the participation of experts, as well as the participation of the United Kingdom in governing boards and structures created for the purposes of implementing Union programmes or activities defined in Protocol I.

*Section 2: Rules for financing the participation in Union programmes and activities*

Article UNPRO.2.1: Financial conditions

1. Participation of the United Kingdom or United Kingdom entities in Union programmes, activities or parts thereof shall be subject to the United Kingdom contributing financially to the corresponding funding under the Union budget.

2. The financial contribution shall take the form of the sum of:

- (a) a participation fee; and
- (b) an operational contribution.

3. The financial contribution shall take the form of an annual payment made in one or more instalments.

4. Without prejudice to Article UNPRO.8 [Participation fee in the years 2021 to 2026], the participation fee shall be 4% of the annual operational contribution and shall not be subject to retrospective adjustments except in relation to suspension under point (b) of Article UNPRO.3.1(7) [Suspension of the participation of the United Kingdom in a Union programme by the Union] and termination under point (c) of Article UNPRO.3.3.(6) [Termination of the participation in a programme or activity in the case of substantial modification to Union programmes]. As of 2028 the level of the participation fee may be adjusted by the Specialised Committee on Participation in Union Programmes.

5. The operational contribution shall cover operational and support expenditure and be additional both in commitment and payment appropriations to the amounts entered in the Union budget definitively adopted for programmes or activities or exceptionally parts thereof increased, where appropriate, by external assigned revenue that does not result from financial contributions to Union programmes and activities from other donors, as defined in Protocol I.

6. The operational contribution shall be based on a contribution key defined as the ratio of the Gross Domestic Product (GDP) of the United Kingdom at market prices to the GDP of the Union at market prices. The GDPs at market prices to be applied shall be the latest available as of 1 January of the year in which the annual payment is made in as provided by Statistical Office of the European Union (EUROSTAT), as soon as the arrangement referred to in Article UNPRO.5.2 [Statistical cooperation] applies and according to the rules of this arrangement. Before this arrangement applies, the GDP of the United Kingdom shall be the one established on the basis of data provided by the Organisation for Economic Co-operation and Development (OECD).

7. The operational contribution shall be based on the application of the contribution key to the initial commitment appropriations increased as described in paragraph 5 entered in the Union budget definitively adopted for the applicable year for financing the Union programmes or activities or exceptionally parts thereof in which the United Kingdom participates.

8. The operational contribution of a programme, activity or part thereof for a year N may be adjusted upwards or downwards retrospectively in one or more subsequent years on the basis of the budgetary commitments made on the commitment appropriations of that year, their implementation through legal commitments and their decommitment.

The first adjustment shall be made in year N+1 when the initial contribution shall be adjusted upwards or downwards by the difference between the initial contribution and an adjusted contribution calculated by applying the contribution key of year N to the sum of:

- (a) the amount of budgetary commitments made on commitment appropriations authorised in year N under the European Union voted budget and on commitment appropriations corresponding to decommitments made available again; and
- (b) any external assigned revenue appropriations that do not result from financial contributions to Union programmes and activities from other donors as defined in Protocol I and that were available at the end of year N.

Each subsequent year, until all the budgetary commitments financed under commitment appropriations originating from year N have been paid or decommitted and at the latest 3 years after the end of the programme or after the end of the multiannual financial framework corresponding to year N, whichever is earlier, the Union shall calculate an adjustment of the contribution of year N by reducing the United Kingdom contribution by the amount obtained by

applying the contribution key of year N to the decommitments made each year on commitments of year N financed under the Union budget or from decommitments made available again.

If external assigned revenue appropriations that do not result from financial contributions to Union programmes and activities from other donors as defined in Protocol I are cancelled, the contribution of the United Kingdom shall be reduced by the amount obtained by applying the contribution key of year N to the amount cancelled.

In year N+2 or in subsequent years, after having made the adjustments referred to in the second, third and fourth subparagraphs, the contribution of the United Kingdom for year N shall also be reduced by an amount obtained by multiplying the contribution of the United Kingdom for year N and the ratio of:

- (a) the legal commitments of year N, funded under any commitment appropriations available in year N, and resulting from competitive award procedures,
  - (i) from which the United Kingdom and the United Kingdom entities have been excluded, or
  - (ii) for which the Specialised Committee on Participation in Union Programmes has decided, in accordance with the procedure established in Article UNPRO.2.1a [Quasi-exclusion from competitive grant award procedure] that there has been a quasi-exclusion of United Kingdom or United Kingdom entities, or
  - (iii) for which the deadline for submission of applications has expired during the suspension referred to in Article UNPRO.3.1 [Suspension of the participation of the United Kingdom in a Union programme by the European Union] or after termination referred to in Article UNPRO.3.3 [Termination of the participation in a programme in the case of substantial modification of Union programme] has taken effect, or
  - (iv) for which the participation of the United Kingdom and United Kingdom entities has been limited in accordance with Article UNPRO.3.5(3) [Financial increases review]; and
- (b) the total amount of legal commitments funded under any commitment appropriations of year N.

This amount of legal commitments shall be calculated by taking all budgetary commitments made in year N and deducting the decommitments that have been made on these commitments in year N+1.

9. Upon request, the Union shall provide the United Kingdom with information in relation to its financial participation as included in the budgetary, accounting, performance and evaluation related information provided to the Union budgetary and discharge authorities concerning the Union programmes and activities in which the United Kingdom participates. That information shall be provided having due regard to the Union's and United Kingdom's confidentiality and data protection rules and is without prejudice to the information which the United Kingdom is entitled to receive under Chapter Two [Sound Financial Management] of this Part.

10. All contributions of the United Kingdom or payments from the Union, and the calculation of amounts due or to be received, shall be made in euros.

11. Subject to paragraph 5 and the second subparagraph of paragraph 8 of this Article, the detailed provisions for the implementation of this Article are set out in Annex UNPRO-1 [Implementation of financial conditions]. Annex UNPRO-1 may be amended by the Specialised Committee on Participation in Union Programmes.

#### Article UNPRO.2.1a: Quasi exclusion from competitive grant award procedure

1. When the United Kingdom considers that certain conditions laid down in a competitive grant award procedure amount to a quasi-exclusion of United Kingdom entities, the United Kingdom shall notify the Specialised Committee on Participation in Union Programmes before the deadline for submission of applications in the procedure concerned and shall provide justification. Within three months of the deadline for submission of applications in the award procedure concerned, the Specialised Committee on Participation in Union Programmes shall examine the notification referred to in the paragraph 1 provided that the participation rate of United Kingdom entities in the award procedure concerned is at least 25 % lower compared to:

- (a) the average participation rate of United Kingdom entities in similar competitive award procedures not containing such a condition and launched within the 3 years preceding the notification; or,
- (b) in the absence of similar competitive award procedures, the average participation rate of United Kingdom entities in all competitive award procedures launched under the programme, or the preceding programme, as relevant, within the 3 years preceding the notification.

3. The Specialised Committee on Participation in Union Programmes shall by the end of the period referred to in paragraph 2, decide whether there has been a quasi-exclusion of the United Kingdom entities from the award procedure concerned in light of the justification provided by the United Kingdom pursuant to paragraph 1 and the effective participation rate in the award procedure concerned.

4. For the purposes of paragraphs 2 and 3, the participation rate shall be the ratio of the number of applications submitted by United Kingdom entities to the total number of applications submitted within the same award procedure.

#### Article UNPRO.2.2: Programmes to which an automatic correction mechanism applies

1. An automatic correction mechanism shall apply in relation to those Union programmes, activities or parts thereof for which the application of an automatic correction mechanism is provided in Protocol I. The application of that automatic correction mechanism may be limited to parts of the programme or activity specified in Protocol I, which are implemented through grants for which competitive calls are organised. Detailed rules on the identification of the parts of the programme or activity to which the automatic correction mechanism does or does not apply may be established in Protocol I.

2. The amount of the automatic correction for a programme or activity or parts thereof shall be the difference between the initial amounts of the legal commitments actually entered into with the United Kingdom or United Kingdom entities financed from commitment appropriations of the year in question and the corresponding operational contribution paid by the United Kingdom as adjusted pursuant to Article UNPRO.2.1(8) [Financial conditions], excluding support expenditure, covering the same period if that amount is positive.

3. Any amount referred to in paragraph 2 of this Article, which for each of two consecutive years exceeds 8% of the corresponding contribution of the United Kingdom to the programme as adjusted pursuant to Article UNPRO.2.1(8) [Financial conditions] shall be due by the United Kingdom as an additional contribution under the automatic correction mechanism for each of those two years.

4. Detailed rules on the establishment of the relevant amounts of the legal commitments referred to in paragraph 2 of this Article, including in the case of consortia, and on the calculation of the automatic correction may be laid down in Protocol I.

#### Article UNPRO.2.3: Financing in relation to programmes implemented through financial instruments or budgetary guarantees

1. Where the United Kingdom participates in a Union programme, activity, or parts thereof that is implemented through a financial instrument or budgetary guarantee, the contribution of the United Kingdom to programmes implemented through financial instruments or budgetary guarantees under the Union budget implemented under Title X of the Financial Regulation applicable to the general budget of the Union shall be made in the form of cash. The amount contributed in cash shall increase the Union budgetary guarantee or the financial envelope of the financial instrument.

2. Where the United Kingdom participates in a programme referred to in paragraph 1 that is implemented by the European Investment Bank Group, if the European Investment Bank Group needs to cover losses that are not covered by the guarantee provided by the Union budget, the United Kingdom shall pay to the European Investment Bank Group a percentage of those losses equal to the ratio of the Gross Domestic Product at market prices of the United Kingdom to the sum of the Gross Domestic Product at market prices of the Member States, the United Kingdom and any other third country participating in that programme. The Gross Domestic Product at market prices to be applied shall be the latest available as of 1 January of the year in which the payment is due as provided by EUROSTAT, as soon as the arrangement referred to in Article UNPRO.5.2 [Statistical cooperation] applies and according to the rules of this arrangement. Before this arrangement applies, the GDP of the United Kingdom shall be the one established on the basis of data provided by the OECD.

3. Where appropriate, modalities for the implementation of this Article, in particular ensuring that the United Kingdom receives its share of unused contributions to budgetary guarantees and financial instruments, shall be specified further in Protocol I.

#### *Section 3: Suspension and termination of the participation in Union programmes*

#### Article UNPRO.3.1: Suspension of the participation of the United Kingdom in a Union programme by the Union

1. The Union may unilaterally suspend the application of Protocol I, in relation to one or more Union programmes, activities, or exceptionally parts thereof in accordance with this Article, if the United Kingdom does not pay its financial contribution in accordance with Section 2 [Rules for financing the participation in Union programmes] of this Chapter or if United Kingdom introduces significant changes to one of the following conditions that existed when the United Kingdom participation in a programme, an activity or exceptionally part thereof was agreed and included in Protocol I, and if such changes have a significant impact on their implementation:

- (a) the conditions for entry and residence in the United Kingdom of the persons that are involved in the implementation of these programmes and activities, or parts thereof, including students, researchers, trainees or volunteers are changed. This shall apply, in particular, if the United Kingdom introduces a change in its domestic laws for the conditions for entry and residence in the United Kingdom for these persons, which discriminates between Member States.
- (b) there is a change in financial charges, including fees, that apply to persons referred in point (a) of this paragraph in order to perform the activities that they have to perform in order to implement the programme;
- (c) the conditions referred to in Article UNPRO.1.5(3) [Conditions for participation] are changed.

2. The Union shall notify the Specialised Committee on Participation in Union Programmes of its intention to suspend the participation of the United Kingdom in the programme or activity concerned. The Union shall identify the scope of the suspension and provide due justification. Unless the Union withdraws its notification, the suspension shall take effect 45 days following the date of notification by the Union. The date on which the suspension takes effect shall constitute the suspension reference date for the purposes of this Article.

Prior to notification and suspension, and during the suspension period, the Specialised Committee on Participation in Union Programmes may discuss appropriate measures for avoiding or lifting the suspension. In case the Specialised Committee on Participation in Union Programmes finds an agreement for avoiding the suspension within the period referred to in the first subparagraph, the suspension shall not take effect.

In any case, the Specialised Committee on Participation in Union Programmes shall meet during the period of 45 days to discuss the matter.

3. As of the suspension reference date the United Kingdom shall not be treated as a country participating in the Union programme, activity, or part thereof concerned by the suspension and in particular, the United Kingdom or United Kingdom entities shall no longer be eligible under the conditions laid down in Article UNPRO.1.4 [Compliance with Programme Rules] and Protocol I, with regard to Union award procedures which have not been completed yet on that date. An award procedure shall be considered completed when legal commitments have been entered into as a result of that procedure.

4. The suspension shall not affect legal commitments entered into before the suspension reference date. This Agreement shall continue to apply to such legal commitments.

5. The United Kingdom shall notify the Union as soon as it considers that compliance with the conditions for participation has been restored, and shall provide the Union with any relevant evidence to that effect.

Within 30 days from that notification the Union shall assess the matter and may, for that purpose, request that the United Kingdom to present additional evidence. The time needed to provide such additional evidence shall not be taken into account in the overall period for assessment.

Where the Union has found that compliance with the conditions for participation is restored, it shall notify without undue delay the Specialised Committee on Participation in Union Programmes that the suspension is lifted. The lifting shall take effect on the day following the date of notification.



Where the Union has found that compliance with the conditions for participation is not restored, the suspension shall remain in force.

6. The United Kingdom shall be treated again as a country participating in the Union programme or activity concerned, and in particular United Kingdom and United Kingdom entities shall be again eligible under the conditions laid down in Article UNPRO.1.4 [Compliance with Programme Rules] and Protocol I, with regard to Union award procedures under that Union programme or activity which were launched after the date on which the lifting of the suspension takes effect, or which were launched before that date, for which the deadline for the submission of applications has not expired.

7. In case of the United Kingdom participation in a programme, activity, or part thereof being suspended, the financial contribution of the United Kingdom that is due during the period of suspension shall be established as follows:

- (a) the Union shall recalculate the operational contribution using the procedure described in point (a)(iii) of the fifth subparagraph of Article UNPRO.2.1(8) [Financial conditions];
- (b) the participation fee shall be adjusted in line with the adjustment of the operational contribution.

#### Article UNPRO.3.2 - Termination of the participation of the United Kingdom in a Union programme by the Union

1. If, by one year after the reference date referred to in Article UNPRO.3.1(2) [Suspension of the participation of the United Kingdom in a Union programme by the European Union] the Union has not lifted the suspension under Article UNPRO.3.1 [Suspension of the participation of the United Kingdom], the Union shall either:

- (a) reassess the conditions under which it may offer to allow the United Kingdom to continue participating in the Union programmes, activities or parts thereof concerned and shall propose those conditions to the Specialised Committee on Participation in Union Programmes within 45 days from expiry of the one year suspension period with a view to modifying Protocol I. In the absence of an agreement on those measures by the Specialised Committee within a further period of 45 days, termination shall take effect as referred to in point (b) of this paragraph; or
- (b) terminate unilaterally the application of Protocol I, in relation to the Union programmes, activities or parts thereof concerned, in accordance with this Article, taking into account the impact of the change referred to in Article UNPRO.3.1 [Suspension of the participation of the United Kingdom] on the implementation of the programme or activity or exceptionally parts thereof, or the amount of the unpaid contribution.

2. The Union shall notify the Specialised Committee on Participation in Union Programmes of its intention to terminate the participation of the United Kingdom in one or more Union programmes or activities pursuant to point (b) of paragraph 1. The Union shall identify the scope of the termination and provide due justification. Unless the Union withdraws its notification, the termination shall take effect 45 days following the date of notification by the Union. The date on which the termination takes effect shall constitute the termination reference date for the purposes of this Article.

3. As of the termination reference date the United Kingdom shall not be treated as a country participating in the Union programme or activity concerned by the termination, and in particular the United Kingdom or United Kingdom entities shall no longer be eligible under the conditions laid down in Article UNPRO.1.4 [Compliance with Programme Rules] and in Protocol I, with regard to Union award procedures which have not been completed yet as of that date. An award procedure shall be considered to have been completed if legal commitments have been entered into as a result of that procedure.

4. The termination shall not affect legal commitments entered into before the suspension reference date referred to in Article UNPRO.3.1(2) [Suspension of the participation of the United Kingdom]. This Agreement shall continue to apply to such legal commitments.

5. Where the application of Protocol I, or a part thereof, is terminated in respect of the programmes or activities or exceptionally parts thereof concerned:

- (a) the operational contribution covering support expenditure related to legal commitments already entered into shall continue to be due until the completion of those legal commitments or the end of the Multi-annual Financial Framework under which the legal commitment has been financed;
- (b) no contribution except the one referred to under point (a) of this paragraph shall be made in the following years.

Article UNPRO.3.3: Termination of the participation in a programme or activity in the case of substantial modification to Union programmes

1. The United Kingdom may unilaterally terminate its participation in a Union programme or activity or part thereof referred to in Protocol I where:

- (a) the basic act of that Union programme or activity is amended to an extent that the conditions for participation of the United Kingdom or of United Kingdom entities in that Union programme or activity have been substantially modified, in particular, as a result of a change of the objectives of the programme or activity and of the corresponding actions; or
- (b) the total amount of commitment appropriations as referred to in Article UNPRO.2.1 [Financial conditions] is increased by more than 15% compared with the initial financial envelope of that programme or activity or part thereof in which the United Kingdom participates and either the corresponding ceiling of the multiannual financial framework has been increased or the amount of external revenue referred to in Article UNPRO.2.1(5) [Financial conditions] for the whole period of participation has been increased; or
- (c) the United Kingdom or United Kingdom entities are excluded from participation in part of a programme or activity on duly justified grounds, and that exclusion concerns commitment appropriations exceeding 10% of the commitment appropriations in the Union budget definitively adopted for a year N for that programme or activity.

2. To this effect, the United Kingdom shall notify its intention to terminate Protocol I in relation to the Union programme or activity concerned, to the Specialised Committee on Participation in Union Programmes at the latest 60 days after the publication of the amendment or of the adopted annual budget or an amendment to it in the Official Journal of the European Union. The United Kingdom shall explain the reasons for which the United Kingdom considers the amendment to



substantially alter the conditions of participation. The Specialised Committee on Participation in Union Programmes shall meet within 45 days of receiving the notification to discuss the matter.

3. Unless the United Kingdom withdraws its notification, the termination shall take effect 45 days following the date of notification by the United Kingdom. The date on which the termination takes effect shall constitute the reference date for the purposes of this Article.

4. As of the reference date the United Kingdom shall not be treated as a country participating in the Union programme or activity concerned by the termination, and in particular the United Kingdom or United Kingdom entities shall no longer be eligible under the conditions laid down in Article UNPRO.1.4 [Compliance with Programme Rules] and in Protocol I, with regard to Union award procedures which have not been completed yet as of that date. An award procedure shall be considered to have been completed if legal commitments have been entered into as a result of that procedure.

5. The termination shall not affect legal commitments entered into before the reference date. This Agreement shall continue to apply to such legal commitments.

6. In case of termination under this Article in respect of the programmes or activities concerned:

- (a) the operational contribution covering support expenditure related to legal commitments already entered into shall continue to be due until the completion of those legal commitments or the end of the Multi-annual Financial Framework under which the legal commitment has been financed;
- (b) the Union shall recalculate the operational contribution of the year where termination occurs using the procedure described in point (a)(iii) of the fifth subparagraph of Article UNPRO.2.1(8) [Financial conditions]. No contribution except the one referred to under point (a) of this Article shall be made in the following years;
- (c) the participation fee shall be adjusted in line with the adjustment of the operational contribution.

#### *Section 4: Review of performance and financial increases*

##### Article UNPRO.3.4: Performance review

1. A performance review procedure shall apply in accordance with the conditions laid down in this Article in relation to parts of the Union programme or activity to which the correction mechanism referred to in Article UNPRO.2.2 [Programmes to which an automatic correction mechanism applies] applies.

2. The United Kingdom may request the Specialised Committee on Participation in Union Programmes to start the performance review procedure where the amount calculated in accordance with the method laid down in Article UNPRO.2.2(2) [Programmes to which an automatic correction mechanism applies] is negative, and where that amount is higher than 12% of the corresponding contributions of the United Kingdom to the programme or activity as adjusted pursuant to Article UNPRO.2.1(8) [Financial conditions].

3. The Specialised Committee on Participation in Union Programmes, within a period of three months from the date of the request referred to in paragraph 2, shall analyse the relevant

performance-related data and adopt a report proposing appropriate measures to address performance related issues.

The measures referred to in the first subparagraph shall be applied for a period of twelve months after the adoption of the report. Following the application of the measures, performance data over the period in question shall be used to calculate the difference between the initial amounts due under the legal commitments actually entered into with the United Kingdom or United Kingdom entities during that calendar year and the corresponding operational contribution paid by the United Kingdom for the same year.

If the difference referred to in the second subparagraph is negative and exceeds 16% of the corresponding operational contribution, the United Kingdom may:

- (a) notify its intention to terminate its participation in the Union programme or part of a programme concerned by giving notice 45 days before the intended day of termination, and may terminate its participation in accordance with Article UNPRO.3.3(3) to (6) [Termination of the participation in a programme in the case of substantial modification of the Union programme]; or
- (b) request the Specialised Committee on Participation in Union Programmes to adopt further measures to address underperformance, including by making adaptations to the participation of the United Kingdom in the Union programme concerned and adjusting future financial contributions of the United Kingdom in respect of that programme.

#### Article UNPRO.3.5: Financial increases review

1. The United Kingdom may notify the Specialised Committee on Participation in Union programmes that it objects to the amount of its contribution to a Union programme or activity if the total amount of commitment appropriations as referred to in Article UNPRO.2.1 [Financial conditions] is increased by more than 5% compared with the initial financial envelope for that Union programme or activity and either the corresponding ceiling has been increased or the amount of external revenue referred to in Article UNPRO.2.1(5) [Financial conditions] for the whole period of participation has been increased.

2. The notification referred to in paragraph 1 shall be made within 60 days as of the publication date of the adopted annual budget or an amendment to it in the Official Journal of the European Union. The notification shall be without prejudice to the obligation of the United Kingdom to pay its contribution and to the application of the adjustment mechanism referred to in Article UNPRO.2.1(8) [Financial conditions].

3. The Specialised Committee on Participation in Union Programmes shall prepare a report, propose and decide on the adoption of appropriate measures within three months from the date of the notification referred to in paragraph 2 of this Article. Those measures may include limiting the participation of the United Kingdom and United Kingdom entities to certain types of actions or award procedures or, where appropriate, a modification of Protocol I. The limitation of the United Kingdom's participation will be treated as an exclusion for the purposes of the adjustment mechanism referred to in Article UNPRO.2.1(8) [Financial conditions].

4. Where the conditions referred to in point (b) of Article UNPRO.3.3(1) [Termination of the participation in a programme in the case of substantial modification of the Union programme] are fulfilled, the United Kingdom may terminate its participation in a Union programme or activity

referred to in Protocol I in accordance with Article UNPRO.3.3(2) to (6) [Termination of the participation in a programme in the case of substantial modification of the Union programme].

## Chapter 2: Sound financial management

### Article UNPRO.4.X-1: Scope

This Chapter shall apply in relation to the Union programmes, activities and services under Union programmes referred to in Protocols I and II.

#### *Section 1: Protection of financial interests and recovery*

### Article UNPRO.4.X: Conduct of activity for the purposes of sound financial management

For the purposes of the application of this Chapter, the authorities of the United Kingdom and of the Union referred to in this Chapter shall cooperate closely in accordance with their respective laws and regulations.

When exercising their duties in the territory of the United Kingdom, the agents and investigative bodies of the Union shall act in a manner consistent with United Kingdom law.

### Article UNPRO.4.1: Reviews and audits

1. The Union shall have the right to conduct as provided in relevant funding agreements or contracts and in accordance with the applicable acts of one or more Union institutions, technical, scientific, financial, or other types of reviews and audits on the premises of any natural person residing in or legal entity established in the United Kingdom and receiving Union funding, as well as any third party involved in the implementation of Union funding residing or established in the United Kingdom. Such reviews and audits may be carried out by the agents of the institutions and bodies of the Union, in particular of the European Commission and the European Court of Auditors, or by other persons mandated by the European Commission in accordance with Union law.

2. The agents of the institutions and bodies of the Union, in particular the agents of the European Commission and the European Court of Auditors, as well as other persons mandated by the European Commission, shall have appropriate access to sites, works and documents (in electronic or paper versions, or both) and to all the information required in order to carry out such reviews and audits, as referred to in paragraph 1. Such access shall include the right to obtain physical or electronic copies of, and extracts from, any document or the contents of any data medium held by audited natural or legal persons, or by the audited third party.

3. The United Kingdom shall not prevent or raise any obstacle to the right of the agents and other persons referred to in paragraph 2 to enter the United Kingdom and to access the premises of the audited persons, in the exercise of their duties referred to in this Article.

4. Notwithstanding the suspension or termination of the United Kingdom's participation in a programme or activity, the suspension of part or all of the provisions of this Part and/or Protocol I or the termination of this Agreement, the reviews and audits may be carried out also after the date on which the relevant suspension or termination takes effect, on the terms laid down in the applicable acts of one or more Union institutions and as provided in the relevant funding agreements or contracts in relation to any legal commitment implementing the Union budget entered into by the Union before the date on which the relevant suspension or termination takes effect.

Article UNPRO.4.2: Fight against irregularities, fraud and other criminal offences affecting the financial interests of the Union

1. The European Commission and the European Anti-Fraud Office (OLAF) shall be authorised to carry out administrative investigations, including on-the-spot checks and inspections, in the territory of the United Kingdom. The European Commission and OLAF shall act in accordance with the Union acts governing those checks, inspections and investigations.
2. The competent United Kingdom authorities shall inform the European Commission or OLAF within a reasonable period of any fact or suspicion which has come to their notice relating to an irregularity, fraud or other illegal activity affecting the financial interests of the Union.
3. On-the-spot checks and inspections may be carried out on the premises of any natural person residing in or legal entity established in the United Kingdom and that receives Union funding under a funding agreement or a contract, as well as on the premises of any third party involved in the implementation of such Union funding residing or established in the United Kingdom. Such checks and inspections shall be prepared and conducted by the European Commission or OLAF in close collaboration with the competent United Kingdom authority designated by the United Kingdom. The designated authority shall be notified within a reasonable period before the checks and inspections of the object, purpose and legal basis of those checks and inspections, to enable it to provide assistance. To that end, the officials of the competent United Kingdom authorities may participate in the on-the-spot checks and inspections.
4. The agents of the European Commission and OLAF shall have access to all the information and documentation (in electronic or paper versions, or both) relating to the operations referred to in paragraph 3, which are required for the proper conduct of the on-the-spot checks and inspections. In particular, the agents of the European Commission and OLAF may copy relevant documents.
5. The European Commission or OLAF and the competent United Kingdom authorities shall decide on a case-by-case basis whether to conduct on-the-spot checks and inspections jointly, including where both parties are competent to conduct investigations.
6. Where the person, entity or another third party who is subject to an on-the-spot check or inspection resists an on-the-spot check or inspection, the United Kingdom authorities, acting in accordance with national rules and regulations, shall assist the European Commission or OLAF, to enable them to fulfil their duties in carrying out the on-the-spot check or inspection. Such assistance shall include taking the appropriate precautionary measures under national law, including measures to safeguard evidence.
7. The European Commission or OLAF shall inform the competent United Kingdom authorities of the result of such checks and inspections. In particular the European Commission or OLAF shall report as soon as possible to the competent United Kingdom authority any fact or suspicion relating to an irregularity which has come to their notice in the course of the on-the-spot check or inspection.
8. Without prejudice to application of United Kingdom law, the European Commission may impose administrative measures and penalties on legal or natural persons participating in the implementation of a programme or activity in accordance with Union legislation.
9. For the purposes of the proper implementation of this Article, the European Commission or OLAF and the United Kingdom competent authorities shall regularly exchange information and, at

the request of one of the parties to this Agreement, consult each other, unless prohibited under Union legislation or under United Kingdom law.

10. In order to facilitate effective cooperation and the exchange of information with OLAF the United Kingdom shall designate a contact point.

11. The exchange of information between the European Commission or OLAF and the United Kingdom competent authorities shall comply with applicable confidentiality requirements. Personal data included in the exchange of information shall be protected in accordance with applicable rules.

12. Without prejudice to the applicability of Article LAW.MUTAS.114 [Definition of competent authority], where any United Kingdom national, or natural persons residing in the United Kingdom, or legal entities established in the United Kingdom receive Union funding under Union programmes and activities listed in Protocol I, directly or indirectly, including in connection with any third party involved in the implementation of such Union funding, the United Kingdom authorities shall cooperate with the Union authorities or authorities of the Member States of the Union responsible for investigating, prosecuting and bringing to judgement the perpetrators of, and accomplices to, criminal offences affecting the financial interests of the Union in relation to such funding, in accordance with the applicable legislation and international instruments, to allow them to fulfil their duties.

Article UNPRO.4.3: Amendments to Articles UNPRO.0.1, UNPRO.4.X-1, UNPRO.4.1 [Reviews and audits] and UNPRO.4.2 [Fight against irregularities, fraud and other criminal offences affecting the financial interests of the Union]

The Specialised Committee on Participation in Union Programmes may amend Articles UNPRO.4.1 [Reviews and audits] and UNPRO.4.2 [Fight against irregularities, fraud and other criminal offences affecting the financial interests of the Union], in particular to take account of changes of acts of one or more Union institutions.

The Specialised Committee on Participation in Union Programmes may amend Article UNPRO.0.1 [Scope] and Article UNPRO.4.X-1 [Scope] to extend the application of this Chapter to other Union programmes, activities and services.

#### Article UNPRO.4.4: Recovery and enforcement

1. Decisions adopted by the European Commission imposing a pecuniary obligation on legal or natural persons other than States in relation to any claims stemming from Union programmes, activities, actions or projects shall be enforceable in the United Kingdom. The order for its enforcement shall be appended to the decision, without any other formality than a verification of the authenticity of the decision by the national authority designated for this purpose by the United Kingdom. The United Kingdom shall make known its designated national authority to the Commission and the Court of Justice of the European Union. In accordance with Article UNPRO.5.1 [Communication and exchange of information], the European Commission shall be entitled to notify such enforceable decisions directly to persons residing and legal entities established in the United Kingdom. The enforcement of those decisions shall take place in accordance with United Kingdom law.

2. Judgments and orders of the Court of Justice of the European Union delivered in application of an arbitration clause contained in a contract or agreement in relation to Union programmes, activities or parts thereof under Protocol I shall be enforceable in the United Kingdom in the same manner as European Commission decisions, as referred to in paragraph 1 of this Article.

3. The Court of Justice of the European Union shall have jurisdiction to review the legality of the decisions of the Commission referred to in paragraph 1 and to suspend the enforcement of such decisions. However, the Courts of the United Kingdom shall have jurisdiction over complaints alleging that enforcement is being carried out in an irregular manner.

### *Section 2: Other rules for the implementation of Union programmes*

#### Article UNPRO.5.1: Communication and exchange of information

The Union institutions and bodies involved in the implementation of Union programmes or activities, or in control of such programmes or activities, shall be entitled to communicate directly, including through electronic exchange systems, with any natural person residing in the United Kingdom or legal entity established in the United Kingdom receiving Union funding, as well as with any third party involved in the implementation of Union funding that resides or is established in the United Kingdom. Such persons, entities and third parties may submit directly to the Union institutions and bodies all relevant information and documentation which they are required to submit on the basis of the Union legislation applicable to the Union programme or activity or on the basis of the contracts or funding agreements concluded to implement that programme or activity.

#### Article UNPRO.5.2: Statistical cooperation

EUROSTAT and the United Kingdom Statistics Authority may establish an arrangement that enables cooperation on relevant statistical matters and includes that EUROSTAT, with the agreement of the United Kingdom Statistics Authority, provides statistical data on the United Kingdom for the purposes of this Part, including, in particular, data on the GDP of the United Kingdom.

### Chapter 3: Access of the United Kingdom to services under Union programmes

#### Article UNPRO.6: Rules on service access

1. Where the United Kingdom does not participate in a Union programme or activity in accordance with Chapter 1 [Participation of the United Kingdom in Union Programmes] of this Part, it may nevertheless have access to services provided under Union programmes and activities under the terms and conditions established in this Agreement, the basic acts and any other rules pertaining to the implementation of Union programmes and activities.

2. Protocol II [Access of the United Kingdom to services established under certain programmes and activities] shall, where appropriate:

- (a) identify the services under Union programmes and activities, to which the United Kingdom and United Kingdom entities shall have access;
- (b) lay down specific conditions for the access by the United Kingdom and United Kingdom entities. Those conditions shall comply with the conditions laid down in this Agreement and in the basic acts;
- (c) where applicable, specify the United Kingdom's financial or in-kind contribution with respect to a service provided under such Union programmes and activities.

3. Protocol II shall be adopted and may be amended by the Specialised Committee on Participation in Union Programmes.

4. The United Kingdom and public and private spacecraft owners and operators operating in or from the United Kingdom shall have access to the services provided under Article 5.1 of Decision No 541/2014 in accordance with Article 5.2 of this decision until provisions on similar access are included in Protocol II or until 31 December 2021.

#### Chapter 4: [Reviews]

##### Article UNPRO.7: *[Review clause]*

Four years after Protocol I and II become applicable, the Specialised Committee on Participation in Union Programmes shall review the implementation thereof on the basis of the data concerning the participation of United Kingdom entities in indirect and direct actions under the programme, parts of the programme, activities and services covered under Protocols I and II.

Following a request by either Party, the Specialised Committee on Participation in Union Programmes shall discuss changes or proposed changes affecting the terms of the United Kingdom participation in any of the programmes or parts of programmes, activities and services listed in Protocols I and II, and, if necessary, may propose appropriate measures within the scope of this Agreement.

#### Chapter 5: Participation fee in the years 2021 to 2026

##### Article UNPRO.8: Participation fee in the years 2021 to 2026

The participation fee referred to in Article UNPRO.2.1(4) [Financial conditions] shall have the following value in the years 2021 to 2026:

- in 2021: 0.5%;
- in 2022: 1%;
- in 2023: 1.5%;
- in 2024: 2%;
- in 2025: 2.5%;
- in 2026: 3%.



## PART SIX: DISPUTE SETTLEMENT AND HORIZONTAL PROVISIONS

### TITLE I: DISPUTE SETTLEMENT

#### Chapter 1: General provisions

##### Article INST.9: Objective

The objective of this Title is to establish an effective and efficient mechanism for avoiding and settling disputes between the Parties concerning the interpretation and application of this Agreement and supplementing agreements, with a view to reaching, where possible, a mutually agreed solution.

##### Article INST.10: Scope

1. This Title applies, subject to paragraphs 2, 3, 4 and 5, to disputes between the Parties concerning the interpretation and application of the provisions of this Agreement or of any supplementing agreement (“covered provisions”).
2. The covered provisions shall include all provisions of this Agreement and of any supplementing agreement with the exception of:
  - (a) paragraphs 1 to 6 of Article GOODS.17 [Trade remedies] and Article GOODS.21 [Cultural property] of Title I of Heading One Part Two;
  - (b) Annex TBT-X [Medicinal products];
  - (c) Title VII [Small and medium sized enterprises] of Heading one of Part Two;
  - (d) Title X [Good regulatory practices and regulatory cooperation] of Heading One of Part Two;
  - (e) paragraphs 1, 2 and 4 of Article LPFS.1.1 [Principles and objectives] and paragraphs 1 and 3 of Article LPFS.1.2 [Right to regulate, precautionary approach and scientific and technical information] of Chapter 1 [General provisions], Chapter 2 [Competition policy], Articles LPFS.3.9 [Independent authority or body and cooperation] and LPFS.3.10 [Courts and tribunals] of Chapter 2 [Subsidy control]; and Chapter 5 [Taxation] of Title XI [Level playing field for open and fair competition and sustainable development] of Heading One of Part Two, and paragraphs 4 to 9 of Article LPFS.9.4 [Rebalancing] of Chapter 9 [Horizontal and institutional provisions] of Title XI [Level playing field for open and fair competition and sustainable development] of Heading One of Part Two;
  - (f) Part Three [Law enforcement and judicial cooperation in criminal matters], including when applying in relation to situations governed by other provisions of this Agreement;
  - (g) Part Four [Thematic cooperation];
  - (h) Title II [Basis for cooperation] of Part Six [Dispute settlement and horizontal provisions];
  - (i) Article FINPROV.10A [Interim provision for transmission of personal data to the United Kingdom] of Part Seven; and
  - (j) the Agreement on security procedures for exchanging and protecting classified information;



3. The Partnership Council may be seized by a Party with a view to resolving a dispute with respect to obligations arising from the provisions referred to in paragraph 2.
4. Article INST.11 [Exclusivity] shall apply to the provisions referred to in paragraph 2.
5. Notwithstanding paragraphs 1 and 2, this Title shall not apply with respect to disputes concerning the interpretation and application of the provisions of the Protocol on Social Security Coordination or its annexes in individual cases.

#### Article INST.11: Exclusivity

The Parties undertake not to submit a dispute between them regarding the interpretation or application of provisions of this Agreement or of any supplementing agreement to a mechanism of settlement other than those provided for in this Agreement.

#### Article INST.12: Choice of forum in case of a substantially equivalent obligation under another international agreement

1. If a dispute arises regarding a measure allegedly in breach of an obligation under this Agreement or any supplementing agreement and of a substantially equivalent obligation under another international agreement to which both Parties are party, including the WTO Agreement, the Party seeking redress shall select the forum in which to settle the dispute.
2. Once a Party has selected the forum and initiated dispute settlement procedures either under this Title or under another international agreement, that Party shall not initiate such procedures under the other international agreement with respect to the particular measure referred to in paragraph 1, unless the forum selected first fails to make findings for procedural or jurisdictional reasons.
3. For the purposes of this Article:
  - (a) dispute settlement procedures under this Title are deemed to be initiated by a Party's request for the establishment of an arbitration tribunal under Article INST.14 [Arbitration procedures];
  - (b) dispute settlement procedures under the WTO Agreement are deemed to be initiated by a Party's request for the establishment of a panel under Article 6 of the Understanding on Rules and Procedure Governing the Settlement of Disputes of the WTO; and
  - (c) dispute settlement procedures under any other agreement are deemed to be initiated if they are initiated in accordance with the relevant provisions of that agreement.
4. Without prejudice to paragraph 2, nothing in this Agreement or any supplementing agreement shall preclude a Party from suspending obligations authorised by the Dispute Settlement Body of the WTO or authorised under the dispute settlement procedures of another international agreement to which the Parties are party. The WTO Agreement or any other international agreement between the Parties shall not be invoked to preclude a Party from suspending obligations under this Title.

#### Chapter 2: Procedure

#### Article INST.13: Consultations

1. If a Party (“the complaining Party”) considers that the other Party (“the respondent Party”) has breached an obligation under this Agreement or under any supplementing agreement, the Parties shall endeavour to resolve the matter by entering into consultations in good faith, with the aim of reaching a mutually agreed solution.
2. The complaining Party may seek consultations by means of a written request delivered to the respondent Party. The complaining Party shall specify in its written request the reasons for the request, including the identification of the measures at issue and the legal basis for the request, and the covered provisions it considers applicable.
3. The respondent Party shall reply to the request promptly, and in any case no later than 10 days after the date of its delivery. Consultations shall be held within 30 days of the date of delivery of the request in person or by any other means of communication agreed by the Parties. If held in person, consultations shall take place in the territory of the respondent Party, unless the Parties agree otherwise.
4. The consultations shall be deemed concluded within 30 days of the date of delivery of the request, unless the Parties agree to continue consultations.
5. Consultations on matters of urgency, including those regarding perishable goods or seasonal goods or services, shall be held within 20 days of the date of delivery of the request. The consultations shall be deemed concluded within those 20 days unless the Parties agree to continue consultations.
6. Each Party shall provide sufficient factual information to allow a complete examination of the measure at issue, including an examination of how that measure could affect the application of this Agreement or any supplementing agreement. Each Party shall endeavour to ensure the participation of personnel of their competent authorities who have expertise in the matter subject to the consultations.
7. For any dispute concerning an area other than Titles I to VII, Chapter four [Energy and raw materials] of Title VIII, Titles IX to XII of Heading One or Heading Six of Part Two, at the request of the complaining Party, the consultations referred to in paragraph 3 of this Article shall be held in the framework of a Specialised Committee or of the Partnership Council. The Specialised Committee may at any time decide to refer the matter to the Partnership Council. The Partnership Council may also seize itself of the matter. The Specialised Committee, or, as the case may be, the Partnership Council, may resolve the dispute by a decision. The time periods referred to in paragraph 3 of this Article shall apply. The venue of meetings shall be governed by the rules of procedure of the Specialised Committee or, as the case may be, the Partnership Council.
8. Consultations, and in particular all information designated as confidential and positions taken by the Parties during consultations, shall be confidential, and shall be without prejudice to the rights of either Party in any further proceedings.

#### Article INST.14: Arbitration procedure

1. The complaining Party may request the establishment of an arbitration tribunal if:

- (a) the respondent Party does not respond to the request for consultations within 10 days of the date of its delivery;
- (b) consultations are not held within the time periods referred to in Article INST.13(3), (4) or (5) [Consultations];
- (c) the Parties agree not to have consultations; or
- (d) consultations have been concluded without a mutually agreed solution having been reached.

2. The request for the establishment of the arbitration tribunal shall be made by means of a written request delivered to the respondent Party. In its request, the complaining Party shall explicitly identify the measure at issue and explain how that measure constitutes a breach of the covered provisions in a manner sufficient to present the legal basis for the complaint clearly.

#### Article INST.15: Establishment of an arbitration tribunal

1. An arbitration tribunal shall be composed of three arbitrators.
2. No later than 10 days after the date of delivery of the request for the establishment of an arbitration tribunal, the Parties shall consult with a view to agreeing on the composition of the arbitration tribunal.
3. If the Parties do not agree on the composition of the arbitration tribunal within the time period provided for in paragraph 2, each Party shall appoint an arbitrator from the sub-list for that Party established pursuant to Article INST.27 [Lists of arbitrators] no later than five days after the expiry of the time period provided for in paragraph 2 of this Article. If a Party fails to appoint an arbitrator from its sub-list within that time period, the co-chair of the Partnership Council from the complaining Party shall select, no later than five days after the expiry of that time period, an arbitrator by lot from the sub-list of the Party that has failed to appoint an arbitrator. The co-chair of the Partnership Council from the complaining Party may delegate such selection by lot of the arbitrator.
4. If the Parties do not agree on the chairperson of the arbitration tribunal within the time period provided for in paragraph 2 of this Article, the co-chair of the Partnership Council from the complaining Party shall select, no later than five days after the expiry of that time period, the chairperson of the arbitration tribunal by lot from the sub-list of chairpersons established pursuant to Article INST.27 [Lists of arbitrators]. The co-chair of the Partnership Council from the complaining Party may delegate such selection by lot of the chairperson of the arbitration tribunal.
5. Should any of the lists provided for in Article INST.27 [Lists of arbitrators] not be established or not contain sufficient names at the time a selection is made pursuant to paragraphs 3 or 4 of this Article, the arbitrators shall be selected by lot from the individuals who have been formally proposed by one Party or both Parties in accordance with Annex INST-X [Rules of procedure].
6. The date of establishment of the arbitration tribunal shall be the date on which the last of the three arbitrators has notified to the Parties the acceptance of his or her appointment in accordance with Annex INST-X [Rules of procedure].

#### Article INST.16: Requirements for arbitrators

1. All arbitrators shall:
  - (a) have demonstrated expertise in law and international trade, including on specific matters covered by Titles I to VII, Chapter four [Energy and raw materials] of Title VIII, Titles IX to XII of Heading One [Trade] of Part Two or Heading Six [Other provisions] of Part Two, or in law and any other matter covered by this Agreement or by any supplementing agreement and, in the case of a chairperson, also have experience in dispute settlement procedures;
  - (b) not be affiliated with or take instructions from either Party;
  - (c) serve in their individual capacities and not take instructions from any organisation or government with regard to matters related to the dispute; and
  - (d) comply with Annex INST-X [Code of Conduct].]
2. All arbitrators shall be persons whose independence is beyond doubt, who possess the qualifications required for appointment to high judicial office in their respective countries or who are jurisconsults of recognised competence.
3. In view of the subject-matter of a particular dispute, the Parties may agree to derogate from the requirements listed in point (a) of paragraph 1.

#### Article INST.17: Functions of the arbitration tribunal

The arbitration tribunal:

- (a) shall make an objective assessment of the matter before it, including an objective assessment of the facts of the case and the applicability of, and conformity of the measures at issue with, the covered provisions;
- (b) shall set out, in its decisions and rulings, the findings of facts and law and the rationale behind any findings that it makes; and
- (c) should consult regularly with the Parties and provide adequate opportunities for the development of a mutually agreed solution.

#### Article INST.18: Terms of reference

1. Unless the Parties agree otherwise no later than five days after the date of the establishment of the arbitration tribunal, the terms of reference of the arbitration tribunal shall be:

*"to examine, in the light of the relevant covered provisions of this Agreement or of a supplementing agreement, the matter referred to in the request for the establishment of the arbitration tribunal, to decide on the conformity of the measure at issue with the provisions referred to in Article INST.10 [Scope] and to issue a ruling in accordance with Article INST.20 [Ruling of the arbitration tribunal]"*.

2. If the Parties agree on terms of reference other than those referred to in paragraph 1, they shall notify the agreed terms of reference to the arbitration tribunal within the time period

referred to in paragraph 1.

#### Article INST.19: Urgent proceedings

1. If a Party so requests, the arbitration tribunal shall decide, no later than 10 days after the date of its establishment, whether the case concerns matters of urgency.
2. In cases of urgency, the applicable time periods set out in Article INST.20 [Ruling of the Arbitration Tribunal] shall be half the time prescribed therein.

#### Article INST.20: Ruling of the arbitration tribunal

1. The arbitration tribunal shall deliver an interim report to the Parties within 100 days after the date of establishment of the arbitration tribunal. If the arbitration tribunal considers that this deadline cannot be met, the chairperson of the arbitration tribunal shall notify the Parties in writing, stating the reasons for the delay and the date on which the arbitration tribunal plans to deliver its interim report. The arbitration tribunal shall not deliver its interim report later than 130 days after the date of establishment of the arbitration tribunal under any circumstances.
2. Each Party may deliver to the arbitration tribunal a written request to review precise aspects of the interim report within 14 days of its delivery. A Party may comment on the other Party's request within six days of the delivery of the request.
3. If no written request to review precise aspects of the interim report is delivered within the time period referred to in paragraph 2, the interim report shall become the ruling of the arbitration tribunal.
4. The arbitration tribunal shall deliver its ruling to the Parties within 130 days of the date of establishment of the arbitration tribunal. When the arbitration tribunal considers that that deadline cannot be met, its chairperson shall notify the Parties in writing, stating the reasons for the delay and the date on which the arbitration tribunal plans to deliver its ruling. The arbitration tribunal shall not deliver its ruling later than 160 days after the date of establishment of the arbitration tribunal under any circumstances.
5. The ruling shall include a discussion of any written request by the Parties on the interim report and clearly address the comments of the Parties.
6. For greater certainty, a 'ruling' or 'rulings' as referred to in Articles INST.17 [Functions of the arbitration tribunal], INST.18 [Terms of reference], INST.28 [Replacement of arbitrators] and Article INST.29(1), (3), (4) and (6) [Arbitration tribunal rulings and decisions] shall be understood to refer also to the interim report of the arbitration tribunal.

### Chapter 3: Compliance

#### Article INST.21: Compliance measures

1. If, in its ruling referred to in Article INST.20(1) [Ruling of the arbitration tribunal], the arbitration tribunal finds that the respondent Party has breached an obligation under this Agreement or under any supplementing agreement, that Party shall take the necessary measures to

comply immediately with the ruling of the arbitration tribunal in order to bring itself in compliance with the covered provisions.

2. The respondent Party, no later than 30 days after delivery of the ruling, shall deliver a notification to the complaining Party of the measures which it has taken or which it envisages to take in order to comply.

#### Article INST.22: Reasonable Period of Time

1. If immediate compliance is not possible, the respondent Party, no later than 30 days after delivery of the ruling referred to in Article INST.20(1) [Ruling of the arbitration tribunal], shall deliver a notification to the complaining Party of the length of the reasonable period of time it will require for compliance with the ruling referred to in Article INST.20(1) [Ruling of the arbitration tribunal]. The Parties shall endeavour to agree on the length of the reasonable period of time to comply.

2. If the Parties have not agreed on the length of the reasonable period of time, the complaining Party may, at the earliest 20 days after the delivery of the notification referred to in paragraph 1, request in writing that the original arbitration tribunal determines the length of the reasonable period of time. The arbitration tribunal shall deliver its decision to the Parties within 20 days of the date of delivery of the request.

3. The respondent Party shall deliver a written notification of its progress in complying with the ruling referred to in Article INST.20(1) [Ruling of the arbitration tribunal] to the complaining Party at least one month before the expiry of the reasonable period of time.

4. The Parties may agree to extend the reasonable period of time.

#### Article INST.23: Compliance Review

1. The respondent Party shall, no later than the date of expiry of the reasonable period of time, deliver a notification to the complaining Party of any measure that it has taken to comply with the ruling referred to in Article INST.20(1) [Ruling of the arbitration tribunal].

2. When the Parties disagree on the existence of, or the consistency with the covered provisions of, any measure taken to comply, the complaining Party may deliver a request, which shall be in writing, to the original arbitration tribunal to decide on the matter. The request shall identify any measure at issue and explain how that measure constitutes a breach of the covered provisions in a manner sufficient to present the legal basis for the complaint clearly. The arbitration tribunal shall deliver its decision to the Parties within 45 days of the date of delivery of the request.

#### Article INST.24: Temporary Remedies

1. The respondent Party shall, at the request of and after consultations with the complaining Party, present an offer for temporary compensation if:

(a) the respondent Party delivers a notification to the complaining Party that it is not possible to comply with the ruling referred to in Article INST.20(1) [Ruling of the arbitration tribunal]; or

(b) the respondent Party fails to deliver a notification of any measure taken to comply within the deadline referred to in Article INST.21 [Compliance Measures] or before the date of expiry of the reasonable period of time; or

(c) the arbitration tribunal finds that no measure taken to comply exists or that the measure taken to comply is inconsistent with the covered provisions.

2. In any of the conditions referred to in points (a), (b) and (c) of paragraph 1, the complaining Party may deliver a written notification to the respondent Party that it intends to suspend the application of obligations under the covered provisions if:

(a) the complaining Party decides not to make a request under paragraph 1; or

(b) the Parties do not agree on the temporary compensation within 20 days after the expiry of the reasonable period of time or the delivery of the arbitration tribunal decision under Article INST.23 [Compliance Review] if a request under paragraph 1 is made.

The notification shall specify the level of intended suspension of obligations.

3. Suspension of obligations shall be subject to the following conditions:

(a) Obligations under Heading Four [Social security coordination and visas for short-term visits] of Part Two, the Protocol on Social Security Coordination or its annexes or Part Five [Union programmes] may not be suspended under this Article;

(b) By derogation from point (a), obligations under Part Five [Union programmes] may be suspended only where the ruling referred to in Article INST.20(1) [Ruling of the arbitration tribunal] concerns the interpretation and implementation of Part Five [Union programmes];

(c) Obligations outside Part Five [Union programmes] may not be suspended where the ruling referred to in Article INST.20(1) [Ruling of the arbitration tribunal] concerns the interpretation and implementation of Part Five [Union programmes]; and

(d) Obligations under Title II [Services and Investment] of Heading One of Part Two in respect of financial services may not be suspended under this Article, unless the ruling referred to in Article INST.20(1) [Ruling of the arbitration tribunal] concerns the interpretation and application of obligations under Title II [Services and Investment] of Heading One of Part Two in respect of financial services.

4. Where a Party persists in not complying with a ruling of an arbitration panel established under an earlier agreement concluded between the Parties, the other Party may suspend obligations under the covered provisions referred to in Article INST.10 [Scope]. With the exception of the rule in point (a) of paragraph 3, all rules relating to temporary remedies in case of non-compliance and to review of any such measures shall be governed by the earlier agreement.

5. The suspension of obligations shall not exceed the level equivalent to the nullification or impairment caused by the violation.

6. If the arbitration tribunal has found the violation in Heading One [Trade] or Heading Three [Road] of Part Two, the suspension may be applied in another Title of the same Heading as that in



which the tribunal has found the violation, in particular if the complaining party is of the view that such suspension is effective in inducing compliance.

7. If the arbitration tribunal has found the violation in Heading Two [Aviation]:

(a) the complaining party should first seek to suspend obligations in the same Title as that in which the arbitration tribunal has found the violation;

(b) if the complaining party considers that it is not practicable or effective to suspend obligations with respect to the same Title as that in which the tribunal has found the violation, it may seek to suspend obligations in the other Title under the same Heading.

8. If the arbitration tribunal has found the violation in Heading One [Trade], Heading Two [Aviation], Heading Three [Road] or Heading Five [Fisheries] of Part Two, and if the complaining party considers that it is not practicable or effective to suspend obligations within the same Heading as that in which the arbitration tribunal has found the violation, and that the circumstances are serious enough, it may seek to suspend obligations under other covered provisions.

9. In the case of point (b) of paragraph 7 and paragraph 8, the complaining Party shall state the reasons for its decision.

10. The complaining Party may suspend the obligations 10 days after the date of delivery of the notification referred to in paragraph 2 unless the respondent Party made a request under paragraph 11.

11. If the respondent Party considers that the notified level of suspension of obligations exceeds the level equivalent to the nullification or impairment caused by the violation or that the principles and procedures set forth in point (b) of paragraph 7, paragraph 8 or paragraph 9 have not been followed, it may deliver a written request to the original arbitration tribunal before the expiry of the 10 day period set out in paragraph 10 to decide on the matter. The arbitration tribunal shall deliver its decision on the level of the suspension of obligations to the Parties within 30 days of the date of the request. Obligations shall not be suspended until the arbitration tribunal has delivered its decision. The suspension of obligations shall be consistent with that decision.

12. The arbitration tribunal acting pursuant to paragraph 11 shall not examine the nature of the obligations to be suspended but shall determine whether the level of such suspension exceeds the level equivalent to the nullification or impairment caused by the violation. However, if the matter referred to arbitration includes a claim that the principles and procedures set forth in point (b) of paragraph 7, paragraph 8 or paragraph 9 have not been followed, the arbitration tribunal shall examine that claim. In the event the arbitration tribunal determines that those principles and procedures have not been followed, the complaining party shall apply them consistently with point (b) of paragraph 7, paragraph 8 and paragraph 9. The parties shall accept the arbitration tribunal's decision as final and shall not seek a second arbitration procedure. This paragraph shall under no circumstances delay the date as of which the complaining Party is entitled to suspend obligations under this Article.

13. The suspension of obligations or the compensation referred to in this Article shall be temporary and shall not be applied after:



- (a) the Parties have reached a mutually agreed solution pursuant to Article INST.31 [Mutually agreed solution];
- (b) the Parties have agreed that the measure taken to comply brings the respondent Party into compliance with the covered provisions; or
- (c) any measure taken to comply which the arbitration tribunal has found to be inconsistent with the covered provisions has been withdrawn or amended so as to bring the respondent Party into compliance with those covered provisions.

Article INST.25: Review of any measure taken to comply after the adoption of temporary remedies

1. The respondent Party shall deliver a notification to the complaining Party of any measure it has taken to comply following the suspension of obligations or following the application of temporary compensation, as the case may be. With the exception of cases under paragraph 2, the complaining Party shall terminate the suspension of obligations within 30 days from the delivery of the notification. In cases where compensation has been applied, with the exception of cases under paragraph 2, the respondent Party may terminate the application of such compensation within 30 days from the delivery of its notification that it has complied.

2. If the Parties do not reach an agreement on whether the notified measure brings the respondent Party into compliance with the covered provisions within 30 days of the date of delivery of the notification, the complaining Party shall deliver a written request to the original arbitration tribunal to decide on the matter. The arbitration tribunal shall deliver its decision to the Parties within 46 days of the date of the delivery of the request. If the arbitration tribunal finds that the measure taken to comply is in conformity with the covered provisions, the suspension of obligations or compensation, as the case may be, shall be terminated. When relevant, the level of suspension of obligations or of compensation shall be adjusted in light of the arbitration tribunal decision.

Chapter 4: Common procedural provisions

Article INST.26: Receipt of information

1. On request of a Party, or on its own initiative, the arbitration tribunal may seek from the Parties relevant information it considers necessary and appropriate. The Parties shall respond promptly and fully to any request by the arbitration tribunal for such information.

2. On request of a Party, or on its own initiative, the arbitration tribunal may seek from any source any information it considers appropriate. The arbitration tribunal may also seek the opinion of experts as it considers appropriate and subject to any terms and conditions agreed by the Parties, where applicable.

3. The arbitration tribunal shall consider amicus curiae submissions from natural persons of a Party or legal persons established in a Party in accordance with Annex INST-X [Rules of Procedure].

4. Any information obtained by the arbitration tribunal under this Article shall be made available to the Parties and the Parties may submit comments on that information to the arbitration tribunal.

#### Article INST.27: Lists of arbitrators

1. The Partnership Council shall, no later than 180 days after the date of entry into force of this Agreement, establish a list of individuals with expertise in specific sectors covered by this Agreement or its supplementing agreements who are willing and able to serve as members of an arbitration tribunal. The list shall comprise at least 15 persons and shall be composed of three sub-lists:

- (a) one sub-list of individuals established on the basis of proposals by the Union;
- (b) one sub-list of individuals established on the basis of proposals by the United Kingdom; and
- (c) one sub-list of individuals who are not nationals of either Party who shall serve as chairperson to the arbitration tribunal.

Each sub-list shall include at least five individuals. The Partnership Council shall ensure that the list is always maintained at this minimum number of individuals.

2. The Partnership Council may establish additional lists of individuals with expertise in specific sectors covered by this Agreement or by any supplementing agreement. Subject to the agreement of the Parties, such additional lists may be used to compose the arbitration tribunal in accordance with the procedure set out in Article INST.15(3) and (5) [Establishment of an arbitration tribunal]. Additional lists shall be composed of two sub-lists:

- (a) one sub-list of individuals established on the basis of proposals by the Union; and
- (b) one sub-list of individuals established on the basis of proposals by the United Kingdom.

3. The lists referred to in paragraphs 1 and 2 shall not comprise persons who are members, officials or other servants of the Union institutions, of the Government of a Member State, or of the Government of the United Kingdom.

#### Article INST.28: Replacement of arbitrators

If during dispute settlement procedures under this Title, an arbitrator is unable to participate, withdraws, or needs to be replaced because that arbitrator does not comply with the requirements of the Code of Conduct, the procedure set out in Article INST.15 [Establishment of the arbitration tribunal] shall apply. The time period for the delivery of the ruling or decision shall be extended for the time necessary for the appointment of the new arbitrator.

#### Article INST.29: Arbitration tribunal decisions and rulings

1. The deliberations of the arbitration tribunal shall be kept confidential. The arbitration tribunal shall make every effort to draft rulings and take decisions by consensus. If this is not possible, the arbitration tribunal shall decide the matter by majority vote. In no case shall separate opinions of arbitrators be disclosed.

2. The decisions and rulings of the arbitration tribunal shall be binding on the Union and on the United Kingdom. They shall not create any rights or obligations with respect to natural or legal persons.

3. Decisions and rulings of the arbitration tribunal cannot add to or diminish the rights and obligations of the Parties under this Agreement or under any supplementing agreement.

4. For greater certainty, the arbitration tribunal shall have no jurisdiction to determine the legality of a measure alleged to constitute a breach of this Agreement or of any supplementing agreement, under the domestic law of a Party. No finding made by the arbitration tribunal when ruling on a dispute between the Parties shall bind the domestic courts or tribunals of either Party as to the meaning to be given to the domestic law of that Party.

4A. For greater certainty, the courts of each Party shall have no jurisdiction in the resolution of disputes between the Parties under this Agreement.

5. Each Party shall make the rulings and decisions of the arbitration tribunal publicly available, subject to the protection of confidential information.

6. The information submitted by the Parties to the arbitration tribunal shall be treated in accordance with the confidentiality rules laid down in ANNEX-INST-X [Rules of procedure].

#### Article INST.30: Suspension and termination of the arbitration proceedings

At the request of both Parties, the arbitration tribunal shall suspend its work at any time for a period agreed by the Parties and not exceeding 12 consecutive months. The arbitration tribunal shall resume its work before the end of the suspension period at the written request of both Parties, or at the end of the suspension period at the written request of either Party. The requesting Party shall deliver a notification to the other Party accordingly. If a Party does not request the resumption of the arbitration tribunal's work at the expiry of the suspension period, the authority of the arbitration tribunal shall lapse and the dispute settlement procedure shall be terminated. In the event of a suspension of the work of the arbitration tribunal, the relevant time periods shall be extended by the same time period for which the work of the arbitration tribunal was suspended.

#### Article INST.31: Mutually agreed solution

5. The Parties may at any time reach a mutually agreed solution with respect to any dispute referred to in Article INST.10 [Scope].

6. If a mutually agreed solution is reached during panel proceedings, the Parties shall jointly notify the agreed solution to the chairperson of the arbitration tribunal. Upon such notification, the arbitration proceedings shall be terminated.

7. The solution may be adopted by means of a decision of the Partnership Council. Mutually agreed solutions shall be made publicly available. The version disclosed to the public shall not contain any information either Party has designated as confidential.

8. Each Party shall take the measures necessary to implement the mutually agreed solution within the agreed time period.

9. No later than the date of expiry of the agreed time period, the implementing Party shall inform the other Party in writing of any measures thus taken to implement the mutually agreed solution.

#### Article INST.32: Time Periods

1. All time periods laid down in this Title shall be counted in days from the day following the act to which they refer.
2. Any time period referred to in this Title may be modified by mutual agreement of the Parties.
3. The arbitration tribunal may at any time propose to the Parties to modify any time period referred to in this Title, stating the reasons for the proposal.

#### Article INST.34: Costs

1. Each Party shall bear its own expenses derived from the participation in the arbitration tribunal procedure.
2. The Parties shall share jointly and equally the expenses derived from organisational matters, including the remuneration and expenses of the members of the arbitration tribunal. The remuneration of the arbitrators shall be in accordance with INST-ANNEX-X [Rules of procedure].

#### Article INST.34A: Annexes

1. Dispute settlement procedures set out in this Title shall be governed by the rules of procedure set out in ANNEX INST-X [Rules of Procedure] and conducted in accordance with the ANNEX INST-X [Code of Conduct].
2. The Partnership Council may amend the ANNEXES INST-X [Rules of procedure] and INST-X [Code of conduct].

### Chapter 5: Specific arrangements for unilateral measures

#### Article INST.34B: Special procedures for remedial measures and rebalancing

1. For the purposes of Article 3.12 [Remedial measures] of Chapter 3 [Subsidy control] and Article 9.4(2) and (3) [Rebalancing] of Chapter 9 [Institutional provisions] of Title XI [Level playing field for open and fair competition and sustainable development] of Heading One of Part Two, this Title applies with the modifications set out in this Article.
2. By derogation from Article INST.15 [Establishment of an arbitration tribunal] and Annex INST-X [Rules of procedure for dispute settlement], if the Parties do not agree on the composition of the arbitration tribunal within two days, the co-chair of the Partnership Council from the complaining Party shall select, no later than one day after the expiry of the two-day time period, an arbitrator by lot from the sub-list of each Party and the chairperson of the arbitration tribunal by lot from the sub-list of chairpersons established pursuant to Article INST.27 [Lists of arbitrators]. The co-chair of the Partnership Council from the complaining Party may delegate such selection by lot of the arbitrator or chairperson. Each individual shall confirm his or her availability to both Parties within two days from the date on which he or she was informed of his or her appointment. The organisational meeting referred to in Rule 10 of Annex INST-X [Rules of procedure for dispute settlement] shall take place within 2 days from the establishment of the arbitration tribunal.

3. By derogation from Rule 11 of Annex INST-X [Rules of procedure for dispute settlement] the complaining Party shall deliver its written submission no later than seven days after the date of establishment of the arbitration tribunal. The respondent Party shall deliver its written submission no later than seven days after the date of delivery of the written submission of the complaining Party. The arbitration tribunal shall adjust any other relevant time periods of the dispute settlement procedure as necessary to ensure the timely delivery of the report.

4. Article INST.20 [Ruling of the arbitration tribunal] does not apply and references to the ruling in this Title shall be read as references to the ruling referred to in

(a) paragraph 10 of Article 3.12 [Remedial measures] of Chapter 3 [Subsidy control] of Title XI [Level playing field for open and fair competition and sustainable development]; or

(b) point (c) of Article 9.4(3) [Rebalancing].

5. By derogation from Article INST.23(2) [Compliance review], the arbitration tribunal shall deliver its decision to the Parties within 30 days from the date of delivery of the request.

Article INST.34C: Suspension of obligations for the purposes of Article LPFS.3.12(12), Article FISH.9(5) and Article FISH.14(7)

1. The level of suspension of obligations shall not exceed the level equivalent to the nullification or impairment of benefits under this Agreement or under a supplementing agreement that is directly caused by the remedial measures from the date the remedial measures enter into effect until the date of the delivery of the arbitration ruling.

2. The level of suspension of obligations requested by the complaining Party and the determination of the level of suspension of obligations by the arbitration tribunal shall be based on facts demonstrating that the nullification or impairment arises directly from the application of the remedial measure and affects specific goods, service suppliers, investors or other economic actors and not merely on allegation, conjecture or remote possibility.

3. The level of nullified or impaired benefits requested by the complaining Party or determined by the arbitration tribunal:

(a) shall not include punitive damages, interest or hypothetical losses of profits or business opportunities;

(b) shall be reduced by any prior refunds of duties, indemnification of damages or other forms of compensation already received by the concerned operators or the concerned Party; and

(c) shall not include the contribution to the nullification or impairment by wilful or negligent action or omission of the concerned Party or any person or entity in relation to whom remedies are sought pursuant to the intended suspension of obligations.

Article INST.34D: Conditions for rebalancing, remedial, compensatory and safeguard measures

Where a Party takes a measure under Article 3.12 [Remedial measures] of Chapter three [Subsidy control] or Article 9.4 [Rebalancing] of Chapter nine [Institutional provisions] of Title XI [Level playing field for open and fair competition and sustainable development] of Heading One [Trade], Article ROAD.11 [Remedial measures] of Heading Three [Road transport], Article FISH.9 [Compensatory measures in case of withdrawal or reduction of access] or Article FISH.14 [Remedial measures and

dispute resolution] of Heading Five of Part Two or Article INST.36 [Safeguards] of Title III of Part Six, that measure shall only be applied in respect of covered provisions within the meaning of Article INST.10 [Scope] and shall comply, mutatis mutandis, with the conditions set out in Article INST.24(3) [Temporary remedies].

## *TITLE II: BASIS FOR COOPERATION*

### Article COMPROV.4: Democracy, rule of law and human rights

1. The Parties shall continue to uphold the shared values and principles of democracy, the rule of law, and respect for human rights, which underpin their domestic and international policies. In that regard, the Parties reaffirm their respect for the Universal Declaration of Human Rights and the international human rights treaties to which they are parties.
2. The Parties shall promote such shared values and principles in international forums. The Parties shall cooperate in promoting those values and principles, including with or in third countries.

### Article COMPROV.5: Fight against climate change

1. The Parties consider that climate change represents an existential threat to humanity and reiterate their commitment to strengthening the global response to this threat. The fight against human-caused climate change as elaborated in the United Nations Framework Convention on Climate Change (UNFCCC) process, and in particular in the Paris Agreement adopted by the Conference of the Parties to the United Nations Framework Convention on Climate Change at its 21st session (the "Paris Agreement"), inspires the domestic and external policies of the Union and the United Kingdom. Accordingly, each Party shall respect the Paris Agreement and the process set up by the UNFCCC and refrain from acts or omissions that would materially defeat the object and purpose of the Paris Agreement.
2. The Parties shall advocate the fight against climate change in international forums, including by engaging with other countries and regions to increase their level of ambition in the reduction of greenhouse emissions.

### Article COMPROV.6: Countering proliferation of weapons of mass destruction

1. The Parties consider that the proliferation of weapons of mass destruction (WMD) and their means of delivery, to both state and non-state actors, represents one of the most serious threats to international stability and security. The Parties therefore agree to cooperate and to contribute to countering the proliferation of weapons of mass destruction and their means of delivery through full compliance with and national implementation of existing obligations under international disarmament and non-proliferation treaties and agreements and other relevant international obligations.
2. The Parties, furthermore, agree to cooperate on and to contribute to countering the proliferation of weapons of mass destruction and their means of delivery by:
  - (a) taking steps to sign, ratify, or accede to, as appropriate, and fully implement all other relevant international instruments; and

- (b) establishing an effective system of national export controls, controlling the export as well as transit of WMD-related goods, including a WMD end-use control on dual use technologies and containing effective sanctions for breaches of export controls.
- 3. The Parties agree to establish a regular dialogue on those matters.

Article COMPROV.7: Small arms and light weapons and other conventional weapons

- 1. The Parties recognise that the illicit manufacture, transfer and circulation of small arms and light weapons (SALW), including their ammunition, their excessive accumulation, their poor management, inadequately secured stockpiles and their uncontrolled spread continue to pose a serious threat to peace and international security.
- 2. The Parties agree to observe and fully implement their respective obligations to deal with the illicit trade in SALW, including their ammunition, under existing international agreements and UN Security Council resolutions, as well as their respective commitments within the framework of other international instruments applicable in this area, such as the UN Programme of Action to prevent, combat and eradicate the illicit trade in SALW in all its aspects.
- 3. The Parties recognise the importance of domestic control systems for the transfer of conventional arms in line with existing international standards. The Parties recognise the importance of applying such controls in a responsible manner, as a contribution to international and regional peace, security and stability, and to the reduction of human suffering, as well as to the prevention of diversion of conventional weapons.
- 4. The Parties undertake, in that regard, to fully implement the Arms Trade Treaty and to cooperate with each other within the framework of that Treaty, including in promoting the universalisation and full implementation of that Treaty by all UN member states.
- 5. The Parties therefore undertake to cooperate in their efforts to regulate or improve the regulation of international trade in conventional arms and to prevent, combat and eradicate the illicit trade in arms.
- 6. The Parties agree to establish a regular dialogue on those matters.

Article COMPROV.8: The most serious crimes of concern to the international community

- 1. The Parties reaffirm that the most serious crimes of concern to the international community as a whole must not go unpunished and that their effective prosecution must be ensured by taking measures at the national level and by enhancing international cooperation, including with the International Criminal Court. The Parties agree to fully support the universality and integrity of the Rome Statute of the International Criminal Court and related instruments.
- 2. The Parties agree to establish a regular dialogue on those matters.

Article COMPROV.9: Counter-terrorism

- 1. The Parties shall cooperate at the bilateral, regional and international levels to prevent and combat acts of terrorism in all its forms and manifestations in accordance with international law, including, where applicable, international counterterrorism-related agreements, international humanitarian law and international human rights law, as well as in accordance with the principles of the Charter of the United Nations.



2. The Parties shall enhance cooperation on counter-terrorism, including preventing and countering violent extremism and the financing of terrorism, with the aim of advancing their common security interests, taking into account the United Nations Global Counter-Terrorism Strategy and relevant United Nations Security Council resolutions, without prejudice to law enforcement and judicial cooperation in criminal matters and intelligence exchanges.

3. The Parties agree to establish a regular dialogue on those matters. This dialogue will, *inter alia*, aim to promote and facilitate:

- (a) the sharing of assessments on the terrorist threat;
- (b) the exchange of best practices and expertise on counter terrorism;
- (c) operational cooperation and exchange of information; and
- (d) exchanges on cooperation in the framework of multilateral organisations.

#### Article COMPROV.10: Personal data protection

1. The Parties affirm their commitment to ensuring a high level of personal data protection. They shall endeavour to work together to promote high international standards.

2. The Parties recognise that individuals have a right to the protection of personal data and privacy and that high standards in this regard contribute to trust in the digital economy and to the development of trade, and are a key enabler for effective law enforcement cooperation. To that end, the Parties shall undertake to respect, each in the framework of their respective laws and regulations, the commitments they have made in this Agreement in connection with that right.

3. The Parties shall cooperate at bilateral and multilateral levels, while respecting their respective laws and regulations. Such cooperation may include dialogue, exchanges of expertise, and cooperation on enforcement, as appropriate, with respect to personal data protection.

4. Where this Agreement or any supplementing agreement provide for the transfer of personal data, such transfer shall take place in accordance with the transferring Party's rules on international transfers of personal data. For greater certainty, this paragraph is without prejudice to the application of any specific provisions in this Agreement relating to the transfer of personal data, in particular Article DIGIT.7 [Protection of personal data and privacy] and Article LAWGEN.4 [Protection of personal data], and to Title I of Part Six [Dispute Settlement]. Where needed, each Party will make best efforts, while respecting its rules on international transfers of personal data, to establish safeguards necessary for the transfer of personal data, taking into account any recommendations of the Partnership Council under point (h) of Article INST.1(4) [Partnership Council].

#### Article COMPROV.11: Global cooperation on issues of shared economic, environmental and social interest

1. The Parties recognise the importance of global cooperation to address issues of shared economic, environmental and social interest. Where it is in their mutual interest, they shall promote multilateral solutions to common problems.

2. While preserving their decision-making autonomy, and without prejudice to other provisions of this Agreement or any supplementing agreement, the Parties shall endeavour to cooperate on current and emerging global issues of common interest such as peace and security, climate change, sustainable development, cross-border pollution, environmental protection, digitalisation, public



health and consumer protection, taxation, financial stability, and free and fair trade and investment. To that end, they shall endeavour to maintain a constant and effective dialogue and to coordinate their positions in multilateral organisations and forums in which the Parties participate, such as the United Nations, the Group of Seven (G-7) and the Group of Twenty (G-20), the Organisation for Economic Co-operation and Development, the International Monetary Fund, the World Bank and the World Trade Organization.

#### Article COMPROV.12: Essential elements

Article COMPROV.4(1) [Democracy, rule of law and human rights], Article COMPROV.5(1) [Fight against climate change] and Article COMPROV.6(1) [Countering proliferation of weapons of mass destruction] constitute essential elements of the partnership established by this Agreement and any supplementing agreement.

#### *TITLE III: FULFILLMENT OF OBLIGATIONS AND SAFEGUARD MEASURES*

#### Article INST.35: Fulfilment of obligations described as essential elements

1. If either Party considers that there has been a serious and substantial failure by the other Party to fulfil any of the obligations that are described as essential elements in Article COMPROV.12 [Essential elements], it may decide to terminate or suspend the operation of this Agreement or any supplementing agreement in whole or in part.
2. Before doing so, the Party invoking the application of this Article shall request that the Partnership Council meet immediately, with a view to seeking a timely and mutually agreeable solution. If no mutually agreeable solution is found within 30 days from the date of the request to the Partnership Council, the Party may take the measures referred to in paragraph 1.
3. The measures referred to in paragraph 1 shall be in full respect of international law and shall be proportionate. Priority shall be given to the measures which least disturb the functioning of this Agreement and of any supplementing agreements.
4. The Parties consider that, for a situation to constitute a serious and substantial failure to fulfil any of the obligations described as essential elements in Article COMPROV.12 [Essential Elements], its gravity and nature would have to be of an exceptional sort that threatens peace and security or that has international repercussions. For greater certainty, an act or omission which materially defeats the object and purpose of the Paris Agreement shall always be considered as a serious and substantial failure for the purposes of this Article.

#### Article INST.36: Safeguard measures

1. If serious economic, societal or environmental difficulties of a sectorial or regional nature, including in relation to fishing activities and their dependent communities, that are liable to persist arise, the Party concerned may unilaterally take appropriate safeguard measures. Such safeguard measures shall be restricted with regard to their scope and duration to what is strictly necessary in order to remedy the situation. Priority shall be given to those measures which will least disturb the functioning of this Agreement.
2. The Party concerned shall, without delay, notify the other Party through the Partnership Council and shall provide all relevant information. The Parties shall immediately enter into consultations in the Partnership Council with a view to finding a mutually agreeable solution.

3. The Party concerned may not take safeguard measures until one month has elapsed after the date of notification referred to in paragraph 2, unless the consultation procedure pursuant to paragraph 2 has been jointly concluded before the expiration of the stated time limit. When exceptional circumstances requiring immediate action exclude prior examination, the Party concerned may apply forthwith the safeguard measures strictly necessary to remedy the situation.

The Party concerned shall, without delay, notify the measures taken to the Partnership Council and shall provide all relevant information.

4. If a safeguard measure taken by the Party concerned creates an imbalance between the rights and obligations under this Agreement or under any supplementing agreement, the other Party may take such proportionate rebalancing measures as are strictly necessary to remedy the imbalance. Priority shall be given to those measures which will least disturb the functioning of this Agreement. Paragraphs 2 to 4 shall apply *mutatis mutandis* to such rebalancing measures.

5. Either Party may, without having prior recourse to consultations pursuant to Article INST.13 [Consultations], initiate the arbitration procedure referred to in Article INST.14 [Arbitration procedure] to challenge a measure taken by the other Party in application of paragraphs 1 to 5 of this Article.

6. The safeguard measures referred to in paragraph 1 and the rebalancing measures referred to in paragraph 5 may also be taken in relation to a supplementing agreement, unless otherwise provided therein.

## **PART SEVEN: FINAL PROVISIONS**

### Article FINPROV.1: Territorial scope

1. This Agreement applies to:
  - (a) the territories to which the Treaty on European Union and the Treaty on the Functioning of the European Union and the Treaty establishing the European Atomic Energy Community are applicable, and under the conditions laid down in those Treaties; and
  - (b) the territory of the United Kingdom.
2. This Agreement also applies to the Bailiwick of Guernsey, the Bailiwick of Jersey and the Isle of Man to the extent set out in Heading Five [Fisheries] and Article OTH.9 [Geographical application] of Heading Six [Other provisions] of Part Two of this Agreement.
3. This Agreement shall neither apply to Gibraltar nor have any effects in that territory.
4. This Agreement does not apply to the overseas territories having special relations with the United Kingdom: Anguilla; Bermuda; British Antarctic Territory; British Indian Ocean Territory; British Virgin Islands; Cayman Islands; Falkland Islands; Montserrat; Pitcairn, Henderson, Ducie and Oeno Islands; Saint Helena, Ascension and Tristan da Cunha; South Georgia and the South Sandwich Islands; and Turks and Caicos Islands.

### Article FINPROV.2: Relationship with other agreements

This Agreement and any supplementing agreement apply without prejudice to any earlier bilateral agreement between the United Kingdom of the one part and the Union and the European Atomic Energy Community of the other part. The Parties reaffirm their obligations to implement any such Agreement.

### Article FINPROV.3: Review

The Parties shall jointly review the implementation of this Agreement and supplementing agreements and any matters related thereto five years after the entry into force of this Agreement and every five years thereafter.

### Article FINPROV.6: Classified information and sensitive non-classified information

Nothing in this Agreement or in any supplementing agreement shall be construed as requiring a Party to make available classified information.

Classified information or material provided by or exchanged between the Parties under this Agreement or any supplementing agreement shall be handled and protected in compliance with the Agreement on security procedures for exchanging and protecting classified information and any implementing arrangement concluded under it.

The Parties shall agree upon handling instructions to ensure the protection of sensitive non-classified information exchanged between them.

## Article FINPROV.7: Integral parts of this Agreement

1. The Protocols, Annexes, Appendices and footnotes to this Agreement shall form an integral part of this Agreement.
2. Each of the Annexes to this Agreement, including its appendices, shall form an integral part of the Section, Chapter, Title, Heading or Protocol that refers to that Annex or to which reference is made in that Annex. For greater certainty:
  - (a) Annex INST-X [RULES OF PROCEDURE OF THE PARTNERSHIP COUNCIL AND COMMITTEES] forms an integral part of Title III [Institutional provisions] of Part One;
  - (b) Annexes ORIG-1 [INTRODUCTORY NOTES TO PRODUCT SPECIFIC RULES OF ORIGIN], ORIG-2 [PRODUCT SPECIFIC RULES OF ORIGIN], ORIG-2A [ORIGIN QUOTAS AND ALTERNATIVES TO THE PRODUCT-SPECIFIC RULES OF ORIGIN IN ANNEX ORIG-2], ORIG-2B [TRANSITIONAL PRODUCT-SPECIFIC RULES FOR ELECTRIC ACCUMULATORS AND ELECTRIFIED VEHICLES], ORIG-3 [SUPPLIER'S DECLARATION], ORIG-4 [TEXT OF THE STATEMENT OF ORIGIN], ORIG-5 [JOINT DECLARATION CONCERNING THE PRINCIPALITY OF ANDORRA] and ORIG-6 [JOINT DECLARATION CONCERNING THE REPUBLIC OF SAN MARINO] form an integral part of Chapter two [Rules of Origin] of Title I of Heading One of Part Two;
  - (c) Annex SPS-1 [CRITERIA REFERRED TO IN ARTICLE SPS.19(d)] forms an integral part of Chapter Three [Sanitary and Phytosanitary Measures] of Title I of Heading One of Part Two;
  - (d) Annex TBT-XX [ARRANGEMENT REFERRED TO IN ARTICLE TBT.9(4) FOR THE REGULAR EXCHANGE OF INFORMATION IN RELATION TO THE SAFETY OF NON-FOOD PRODUCTS AND RELATED PREVENTIVE, RESTRICTIVE AND CORRECTIVE MEASURES], Annex TBT-ZZ [ARRANGEMENT REFERRED TO IN ARTICLE TBT.9(5) FOR THE REGULATORY EXCHANGE OF INFORMATION REGARDING MEASURES TAKEN ON NON-COMPLAINT NON-FOOD PRODUCTS, OTHER THAN THOSE COVERED BY ARTICLE TBT.9(4), Annex TBT-1 [MOTOR VEHICLES AND EQUIPMENT AND PARTS THEREOF], Annex TBT-2 [MEDICINAL PRODUCTS], Annex TBT-3 [CHEMICALS], Annex TBT-4 [ORGANIC PRODUCTS] and Annex TBT-5 [TRADE IN WINE] form an integral part of Chapter Four [Technical Barriers to Trade] of Title I of Heading One of Part Two;
  - (e) Annex CUSTMS-1 [AUTHORISED ECONOMIC OPERATORS] forms an integral part of Chapter Five [Customs and trade facilitation] of Title I of Heading One of Part Two;
  - (f) Annexes SERVIN-1 [EXISTING MEASURES], SERVIN-2 [FUTURE MEASURES], SERVIN-3 [BUSINESS VISITORS FOR ESTABLISHMENT PURPOSES, INTRA-CORPORATE TRANSFEREES AND SHORT-TERM BUSINESS VISITORS], SERVIN-4 [CONTRACTUAL SERVICE SUPPLIERS AND INDEPENDENT PROFESSIONALS], SERVIN-5 [MOVEMENT OF NATURAL PERSONS] and SERVIN-6 [GUIDELINES FOR ARRANGEMENTS ON THE RECOGNITION OF PROFESSIONAL QUALIFICATIONS] form an integral part of Title II [Services and Investment] of Heading One of Part Two;
  - (g) Annex PPROC-1 [PUBLIC PROCUREMENT] forms an integral part of Title VI [Public procurement] of Heading One of Part Two;
  - (h) Annexes ENER-1 [LISTS OF ENERGY GOODS, HYDROCARBONS AND RAW MATERIALS], ENER-2 [ENERGY AND ENVIRONMENTAL SUBSIDIES], ENER-3 [NON-APPLICATION OF THIRD-PARTY ACCESS AND OWNERSHIP UNBUNDLING TO INFRASTRUCTURE] and ENER-4 [ALLOCATION OF

ELECTRICITY INTERCONNECTOR CAPACITY AT THE DAY-AHEAD MARKET TIMEFRAME] form an integral part of Title VIII [Energy] of Heading One of Part Two;

- (i) Annex ENER-2 [ENERGY AND ENVIRONMENTAL SUBSIDIES] forms an integral part of Title XI [LPFOFCSD] of Heading One of Part Two;
- (j) Annex AVSAF-1 [AIRWORTHINESS AND ENVIRONMENT CERTIFICATION] and any annex adopted in accordance with Article AVSAF.12 [Adoption and amendments of Annexes to this Title] form an integral part of Title Two [Aviation safety] of Heading Two of Part Two;
- (k) Annex ROAD-1 [TRANSPORT OF GOODS BY ROAD] forms an integral part of Title I [Transport of goods by road] of Heading Three of Part Two;
- (l) Annexes ROAD-2 [MODEL OF AUTHORISATION FOR AN INTERNATIONAL REGULAR AND SPECIAL REGULAR SERVICE], ROAD-3 [MODEL OF APPLICATION FOR AN AUTHORISATION FOR AN INTERNATIONAL REGULAR AND SPECIAL REGULAR SERVICE] and ROAD-4 [MODEL OF JOURNEY FORM FOR OCCASIONAL SERVICES] form an integral part of Title II [Transport of passengers by road] of Heading Three of Part Two;
- (m) [Annexes FISH.1, FISH.2, FISH.3 and FISH.4 [PROTOCOL ON ACCESS TO WATERS] form an integral part of Heading Five [Fisheries] of Part Two];
- (n) Annex LAW-1 [EXCHANGES OF DNA, FINGERPRINTS AND VEHICLE REGISTRATION DATA] forms an integral part of Title II [Exchanges of DNA, fingerprints and vehicle registration data] of Part Three;
- (o) Annex LAW-2 [PASSENGER NAME RECORD DATA] forms an integral part of Title III [Transfer and processing of passenger name record data] of Part Three;
- (p) Annex LAW-3 [FORMS OF CRIME FOR WHICH EUROPOL IS COMPETENT] forms an integral part of Title V [Cooperation with Europol] of Part Three;
- (q) Annex LAW-4 [FORMS OF SERIOUS CRIME FOR WHICH EUROJUST IS COMPETENT] forms an integral part of Title VI [Cooperation with Eurojust] of Part Three;
- (r) Annex LAW-5 [ARREST WARRANT] forms an integral part of Title VII [Surrender] of Part Three;
- (s) Annex LAW-6 [EXCHANGE OF CRIMINAL RECORD INFORMATION – TECHNICAL AND PROCEDURAL SPECIFICATIONS] forms an integral part of Title IX [Exchange of criminal record information] of Part Three;
- (t) Annex LAW-7 [DEFINITION OF TERRORISM] forms an integral part of Title III [Transfer and processing of passenger name record data], Title VII [Surrender] and Title XI [Freezing and confiscation] of Part Three;
- (u) Annex LAW-8 [FREEZING AND CONFISCATION] forms an integral part of Title XI [Freezing and confiscation] of Part Three;
- (v) Annex UNPRO-1 [IMPLEMENTATION OF THE FINANCIAL CONDITIONS [Article UNPRO.2.1.11]] forms an integral part of Section 2 [Rules for financing the participation in Union programmes and activities] of Chapter one of Part Five [Participation in Union programmes, sound financial management and financial provisions];
- (w) Annex INST-X [RULES OF PROCEDURE FOR DISPUTE SETTLEMENT] and Annex INST-X [CODE OF CONDUCT FOR ARBITRATORS] form an integral part of Title I [Dispute Settlement] of Part Six;

- (x) the ANNEX TO THE PROTOCOL ON ADMINISTRATIVE COOPERATION AND COMBATING FRAUD IN THE FIELD OF VALUE ADDED TAX AND ON MUTUAL ASSISTANCE FOR THE RECOVERY OF CLAIMS RELATING TO TAXES AND DUTIES forms an integral part of the Protocol on administrative cooperation and combating fraud in the field of value added tax and on mutual assistance for the recovery of claims relating to taxes and duties;
- (y) Annexes SSC-1 [CERTAIN BENEFITS IN CASH TO WHICH THE PROTOCOL SHALL NOT APPLY], SSC-2 [RESTRICTION OF RIGHTS TO BENEFITS IN KIND FOR MEMBERS OF THE FAMILY OF A FRONTIER WORKER], SSC-3 [MORE RIGHTS FOR PENSIONERS RETURNING TO THE COMPETENT STATE], SSC-4 [CASES IN WHICH THE PRO RATA CALCULATION SHALL BE WAIVED OR SHALL NOT APPLY], SSC-5 [BENEFITS AND AGREEMENTS WHICH ALLOW THE APPLICATION OF ARTICLE SSC.49 [Overlapping of benefits of the same kind]], SSC-6 [SPECIAL PROVISIONS FOR THE APPLICATION OF THE LEGISLATION OF THE MEMBER STATES AND OF THE UNITED KINGDOM], SSC-7 [IMPLEMENTING PART] and SSC-8 [TRANSITIONAL PROVISIONS REGARDING THE APPLICATION OF ARTICLE SSC.11 [DETACHED WORKERS]] and their Appendices form an integral part of the Protocol on Social Security Coordination.

#### Article FINPROV.8: Termination

Either Party may terminate this Agreement by written notification through diplomatic channels. This Agreement and any supplementing agreement shall cease to be in force on the first day of the twelfth month following the date of notification.

#### Article FINPROV.9: Authentic texts

This Agreement shall be drawn up in duplicate in the Bulgarian, Croatian, Czech, Danish, Dutch, English, Estonian, Finnish, French, German, Greek, Hungarian, Irish, Italian, Latvian, Lithuanian, Maltese, Polish, Portuguese, Romanian, Slovak, Slovenian, Spanish and Swedish languages. By 30 April 2021, all language versions of the Agreement shall be subject to a process of final legal revision. Notwithstanding the previous sentence, the process of final legal revision for the English version of the Agreement shall be finalised at the latest by the day referred to in Article FINPROV.11(1) [Entry into force and provisional application] if that day is earlier than 30 April 2021.

The language versions resulting from the above process of final legal revision shall replace *ab initio* the signed versions of the Agreement and shall be established as authentic and definitive by exchange of diplomatic notes between the Parties.

#### Article FINPROV.10: Future accessions to the Union

1. The Union shall notify the United Kingdom of any new request for accession of a third country to the Union.

2. During the negotiations between the Union and a third country regarding the accession of that country to the Union<sup>86</sup>, the Union shall endeavour to:

(a) on request of the United Kingdom and, to the extent possible, provide any information regarding any matter covered by this Agreement and any supplementing agreement; and

---

<sup>86</sup> For greater certainty, paragraphs 2 to 9 apply in respect of negotiations between the Union and a third country for accession to the Union taking place after the entry into force of this Agreement, notwithstanding the fact a request for accession took place before the entry into force of this Agreement.

(b) take into account any concerns expressed by the United Kingdom.

3. The Partnership Council shall examine any effects of accession of a third country to the Union on this Agreement and any supplementing agreement sufficiently in advance of the date of such accession.

4. To the extent necessary, the United Kingdom and the Union shall, before the entry into force of the agreement on the accession of a third country to the Union:

(a) amend this Agreement or any supplementing agreement,

(b) put in place by decision of the Partnership Council any other necessary adjustments or transitional arrangements regarding this Agreement or any supplementing agreement;

(c) decide within the Partnership Council whether:

(i) to apply Article VSTV.1 [Visas for short visits] to the nationals of that third country; or

(ii) to establish transitional arrangements as regards Article VSTV.1 [Visas for short visits] in relation to that third country and its nationals once it accedes to the Union.

5. In the absence of a decision under point (c)(i) or (ii) of paragraph 4 by the entry into force of the agreement on the accession of the relevant third country to the Union, Article VSTV.1 [Visas for short visits] shall not apply to nationals of that third country.

6. In the event that the Partnership Council establishes transitional arrangements as referred to in point (c)(ii) of paragraph 4, it shall specify their duration. The Partnership Council may extend the duration of those transitional arrangements.

7. Before the expiry of the transitional arrangements referred to in point (c)(ii) of paragraph 4, the Partnership Council shall decide whether to apply Article VSTV.1 [Visas for short visits] to the nationals of that third country from the end of the transitional arrangements. In the absence of such a decision Article VSTV.1 [Visas for short visits] shall not apply in relation to the nationals of that third country from the end of the transitional arrangements.

8. Point (c) of paragraph 4, and paragraphs 5 to 7 are without prejudice to the Union's prerogatives under its domestic legislation.

9. For greater certainty, without prejudice to point (c) of paragraph 4 and paragraphs 5 to 7, this Agreement shall apply in relation to a new Member State of the Union from the date of accession of that new Member State to the Union.

#### Article FINPROV.10A: Interim provision for transmission of personal data to the United Kingdom

1. For the duration of the specified period, transmission of personal data from the Union to the United Kingdom shall not be considered as transfer to a third country under Union law, provided that the data protection legislation of the United Kingdom on 31 December 2020, as it is saved and incorporated into United Kingdom law by the European Union (Withdrawal) Act 2018 and as



modified by the Data Protection, Privacy and Electronic Communications (Amendments etc) (EU Exit) Regulations 2019<sup>87</sup> (“the applicable data protection regime”), applies and provided that the United Kingdom does not exercise the designated powers without the agreement of the Union within the Partnership Council.

2. Subject to paragraphs 3 to 11, paragraph 1 shall also apply in respect of transfers of personal data from Iceland, the Principality of Liechtenstein and the Kingdom of Norway to the United Kingdom during the specified period made under Union law as applied in those states by the Agreement on the European Economic Area done at Porto on 2 May 1992, for so long as paragraph 1 applies to transfers of personal data from the Union to the United Kingdom, provided that those states notify both Parties in writing of their express acceptance to apply this provision.

3. In this Article, the “designated powers” means the powers:

- (a) to make regulations pursuant to sections 17A, 17C and 74A of the UK Data Protection Act 2018;
- (b) to issue a new document specifying standard data protection clauses pursuant to section 119A of the UK Data Protection Act 2018;
- (c) to approve a new draft code of conduct pursuant to Article 40(5) of the UK GDPR, other than a code of conduct which cannot be relied on to provide appropriate safeguards for transfers of personal data to a third country under Article 46(2)(e) of the UK GDPR;
- (d) to approve new certification mechanisms pursuant to Article 42(5) of the UK GDPR, other than certification mechanisms which cannot be relied on to provide appropriate safeguards for transfers of personal data to a third country under Article 46(2)(f) of the UK GDPR;
- (e) to approve new binding corporate rules pursuant to Article 47 of the UK GDPR;
- (f) to authorise new contractual clauses referred to in Article 46(3)(a) of the UK GDPR; or
- (g) to authorise new administrative arrangements referred to in Article 46(3)(b) of the UK GDPR.

4. The “specified period” begins on the date of entry into force of this Agreement and, subject to paragraph 5, ends:

- (a) on the date on which adequacy decisions in relation to the UK are adopted by the European Commission under Article 36(3) of Directive (EU) 2016/680 and under Article 45(3) of Regulation (EU) 2016/679, or
- (b) on the date four months after the specified period begins, which period shall be extended by two further months unless one of the Parties objects;

whichever is earlier.

5. Subject to paragraphs 6 and 7, if, during the specified period, the United Kingdom amends the applicable data protection regime or exercises the designated powers without the agreement of the Union within the Partnership Council, the specified period shall end on the date on which the powers are exercised or the amendment comes into force.

6. The references to exercising the designated powers in paragraphs 1 and 5 do not include the exercise of such powers the effect of which is limited to alignment with the relevant Union data protection law.

---

<sup>87</sup> As amended by the Data Protection, Privacy and Electronic Communications (Amendments etc) (EU Exit) Regulations 2020.



7. Anything that would otherwise be an amendment to the applicable data protection regime which is:

- (a) made with the agreement of the Union within the Partnership Council; or
- (b) limited to alignment with the relevant Union data protection law;

shall not be treated as an amendment to the applicable data protection regime for the purposes of paragraph 5 and instead should be treated as being part of the applicable data protection regime for the purposes of paragraph 1.

8. For the purposes of paragraphs 1, 5 and 7, “the agreement of the Union within the Partnership Council” means:

- (a) a decision of the Partnership Council as described in paragraph 11; or
- (b) deemed agreement as described in paragraph 10.

9. Where the United Kingdom notifies the Union that it proposes to exercise the designated powers or proposes to amend the applicable data protection regime, either party may request, within five working days, a meeting of the Partnership Council which must take place within two weeks of such request.

10. If no such meeting is requested, the Union is deemed to have given agreement to such exercise or amendment during the specified period.

11. If such a meeting is requested, at that meeting the Partnership Council shall consider the proposed exercise or amendment and may adopt a decision stating that it agrees to the exercise or amendment during the specified period.

12. The United Kingdom shall, as far as is reasonably possible, notify the Union when, during the specified period, it enters into a new instrument which can be relied on to transfer personal data to a third country under Article 46(2)(a) of the UK GDPR or section 75(1)(a) of the UK Data Protection Act 2018 during the specified period. Following a notification by the United Kingdom under this paragraph, the Union may request a meeting of the Partnership Council to discuss the relevant instrument.

13. Title I [Dispute Settlement] of Part Six does not apply in respect of disputes regarding the interpretation and application of this Article.

#### Article FINPROV.11: Entry into force and provisional application

1. This Agreement shall enter into force on the first day of the month following that in which both Parties have notified each other that they have completed their respective internal requirements and procedures for establishing their consent to be bound.

2. The Parties agree to provisionally apply this Agreement from 1 January 2021 provided that prior to that date they have notified each other that their respective internal requirements and procedures necessary for provisional application have been completed. Provisional application shall cease on one of the following dates, whichever is the earliest:

- (a) 28 February 2021 or another date as decided by the Partnership Council; or
- (b) the day referred to in paragraph 1.

3. As from the date from which this Agreement is provisionally applied, the Parties shall understand references in this Agreement to “the date of entry into force of this Agreement” or to “the entry into force of this Agreement” as references to the date from which this Agreement is provisionally applied.

## ANNEXES

### *ANNEX INST: RULES OF PROCEDURE OF THE PARTNERSHIP COUNCIL AND COMMITTEES*

#### Rule 1

##### Chair

1. The Union and the United Kingdom shall notify each other of the name, position and contact details of their respective designated co-chairs. A co-chair is deemed to have the authorisation for representing, respectively, the Union or the United Kingdom until the date a new co-chair has been notified to the other Party.
2. The decisions of the co-chairs provided for by these Rules of Procedure shall be taken by mutual consent.
3. A co-chair may be replaced for a particular meeting by a designee. The co-chair, or his or her designee, shall notify the other co-chair and the Secretariat of the Partnership Council of the designation as early as possible. Any reference in these Rules of Procedure to the co-chairs shall be understood to include a designee.

#### Rule 2

##### Secretariat

The Secretariat of the Partnership Council (the "Secretariat") shall be composed of an official of the Union and an official of the Government of the United Kingdom. The Secretariat shall perform the tasks conferred on it by these Rules of Procedure.

The Union and the United Kingdom shall notify each other of the name, position and contact details of the official who is the member of the Secretariat of the Partnership Council for the Union and the United Kingdom respectively. This official is deemed to continue acting as member of the Secretariat for the Union or for the United Kingdom until the date either the Union or the United Kingdom has notified a new member.

#### Rule 3

##### Meetings

1. Each meeting of the Partnership Council shall be convened by the Secretariat at a date and time agreed by the co-chairs. Where the Union or the United Kingdom has transmitted a request for a meeting through the Secretariat, the Partnership Council shall endeavour to meet within 30 days of such request, or sooner in cases provided for in this Agreement.
2. The Partnership Council shall hold its meetings alternately in Brussels and London, unless the co-chairs decide otherwise.
3. By way of derogation from paragraph 2, the co-chairs may agree that a meeting of the Partnership Council be held by videoconference or teleconference.

## Rule 4

### Participation in meetings

1. A reasonable period of time in advance of each meeting, the Union and the United Kingdom shall inform each other through the Secretariat of the intended composition of their respective delegations and shall specify the name and function of each member of the delegation.
2. Where appropriate the co-chairs may, by mutual consent, invite experts (i.e. non-government officials) to attend meetings of the Partnership Council in order to provide information on a specific subject and only for the parts of the meeting where such specific subjects are discussed.

## Rule 5

### Documents

Written documents on which the deliberations of the Partnership Council are based shall be numbered and circulated to the Union and the United Kingdom by the Secretariat.

## Rule 6

### Correspondence

1. The Union and the United Kingdom shall send their correspondence addressed to the Partnership Council via the Secretariat. Such correspondence may be sent in any form of written communication, including by electronic mail.
2. The Secretariat shall ensure that correspondence addressed to the Partnership Council is delivered to the co-chairs and is circulated, where appropriate, in accordance with Rule 5.
3. All correspondence from, or addressed directly to, the co-chairs shall be forwarded to the Secretariat and shall be circulated, where appropriate, in accordance with Rule 5.

## Rule 7

### Agenda for the meetings

1. For each meeting, a draft provisional agenda shall be drawn up by the Secretariat. It shall be transmitted, together with the relevant documents, to the co-chairs no later than 10 days before the date of the meeting.
2. The provisional agenda shall include items requested by the Union or the United Kingdom. Any such request, together with any relevant document, shall be submitted to the Secretariat no later than 15 days before the beginning of the meeting.
3. No later than 5 days before the date of the meeting, the co-chairs shall decide on the provisional agenda for a meeting.

4. The agenda shall be adopted by the Partnership Council at the beginning of each meeting. On request by the Union or the United Kingdom, an item other than those included in the provisional agenda may be included in the agenda by consensus.

5. The co-chairs may, by mutual consent, reduce or increase the time periods specified in paragraphs 1 to 3 in order to take account of the requirements of a particular case.

## Rule 8

### Minutes

1. Draft minutes of each meeting shall be drawn up by the official acting as member of the Secretariat of the Party hosting the meeting, within 15 days from the end of the meeting, unless otherwise decided by the co-chairs. The draft minutes shall be transmitted for comments to the member of the Secretariat of the other Party. The latter may submit comments within 7 days from the date of receipt of the draft minutes.

2. The minutes shall, as a rule, summarise each item on the agenda, specifying where applicable:

- (a) the documents submitted to the Partnership Council;
- (b) any statement that one of the co-chairs requested to be entered in the minutes; and
- (c) the decisions taken, recommendations made, statements agreed upon and conclusions adopted on specific items.

3. The minutes shall include as an annex a list of participants setting out for each of the delegations the names and functions of all individuals who attended the meeting.

4. The Secretariat shall adjust the draft minutes on the basis of comments received and the draft minutes, as revised, shall be approved by the co-chairs within 28 days of the date of the meeting, or by any other date agreed by the co-chairs. Once approved, two versions of the minutes shall be authenticated by signature of the members of the Secretariat. The Union and the United Kingdom shall each receive one of these authentic versions. The co-chairs may agree that signing and exchanging electronic copies satisfies this requirement.

## Rule 9

### Decisions and Recommendations

1. In the period between meetings, the Partnership Council may adopt decisions or recommendations by written procedure. The text of a draft decision or recommendation shall be presented in writing by a co-chair to the other co-chair in the working language of the Partnership Council. The other Party shall have one month, or any longer period of time specified by the proposing Party, to express its agreement to the draft decision or recommendation. If the other Party does not express its agreement, the proposed decision or recommendation shall be discussed and may be adopted at the next meeting of the Partnership Council. The draft decisions or recommendations shall be deemed to be adopted once the other Party expresses its agreement and shall be recorded in the minutes of the next meeting of the Partnership Council pursuant to Rule 8.

2. Where the Partnership Council adopts decisions or recommendations, the words "Decision" or "Recommendation", respectively, shall be inserted in the title of such acts. The Secretariat shall

record any decision or recommendation under a serial number and with a reference to the date of its adoption.

3. Decisions adopted by the Partnership Council shall specify the date on which they take effect.

4. Decisions and recommendations adopted by the Partnership Council shall be established in duplicate in the authentic languages and signed by the co-chairs and shall be sent by the Secretariat to the Union and the United Kingdom immediately after signature. The co-chairs may agree that signing and exchanging electronic copies satisfies the requirement for signature.

#### Rule 10

##### Transparency

1. The co-chairs may agree that the Partnership Council shall meet in public.

2. Each Party may decide on the publication of the decisions and recommendations of the Partnership Council in its respective official journal or online.

3. If the Union or the United Kingdom submits information that is confidential or protected from disclosure under its laws and regulations to the Partnership Council, the other party shall treat that information received as confidential.

4. Provisional agendas of the meetings shall be made public before the meeting of the Partnership Council takes place. The minutes of the meetings shall be made public following their approval in accordance with Rule 8.

5. Publication of documents referred to in paragraphs 2 to 4 shall be made in compliance with both Parties' applicable data protection rules.

#### Rule 11

##### Languages

1. The official languages of the Partnership Council shall be the official languages of the Union and the United Kingdom.

2. The working language of the Partnership Council shall be English. Unless otherwise decided by the co-chairs, the Partnership Council shall base its deliberations on documents prepared in English.

3. The Partnership Council shall adopt decisions concerning the amendment or interpretation of the Agreement in the languages of the authentic texts of the Agreement. All other decisions of the Partnership Council, including the ones through which the present rules of procedure are amended, shall be adopted in the working language referred to in paragraph 2.

#### Rule 12

##### Expenses

1. The Union and the United Kingdom shall each meet any expenses they incur as a result of participating in the meetings of the Partnership Council.

2. Expenditure in connection with the organisation of meetings and reproduction of documents shall be borne by the party hosting the meeting.

3. Expenditure in connection with interpretation to and from the working language of the Partnership Council at meetings shall be borne by the party requesting such interpretation.

3. Each Party shall be responsible for the translation of decisions and other documents into its own official language(s), if required pursuant to Rule 11, and it shall meet expenditures associated with such translations.

### Rule 13

#### Committees

1. Without prejudice to paragraph 2 of this Rule, Rules 1 to 12 shall apply *mutatis mutandis* to the Committees.

2. The Committees shall inform the Partnership Council of their meeting schedules and agenda sufficiently in advance of their meetings, and shall report to the Partnership Council on the results and conclusions of each of their meetings.

## *ANNEX ORIG-1: INTRODUCTORY NOTES TO PRODUCT-SPECIFIC RULES OF ORIGIN*

### Note 1

#### General Principles

1. This Annex sets out the general rules for the applicable requirements of Annex ORIG-2 [Product-specific rules of origin] as provided for in point (c) of Article ORIG 3(1) [General requirements] of this Agreement.
2. For the purposes of this Annex and Annex ORIG-2 [Product-specific rules of origin], the requirements for a product to be originating in accordance with point (c) of Article ORIG.3(1) [General Requirements] of this Agreement are a change in tariff classification, a production process, a maximum value or weight of non-originating materials, or any other requirement specified in this Annex and Annex ORIG-2 [Product-specific rules of origin].
3. Reference to weight in a product-specific rule of origin means the net weight, which is the weight of a material or a product, not including the weight of any packaging.
4. This Annex and Annex ORIG-2 [Product-specific rules of origin] are based on the Harmonised System, as amended on 1 January 2017.

### Note 2

#### The Structure of the List of Product-specific Rules of Origin

1. Notes on sections or chapters, where applicable, are read in conjunction with the product-specific rules of origin for the relevant section, chapter, heading or subheading.
2. Each product-specific rule of origin set out in Column 2 of Annex ORIG-2 [Product-specific rules of origin] applies to the corresponding product indicated in Column 1 of Annex ORIG-2 [Product-specific rules of origin].
3. If a product is subject to alternative product-specific rules of origin, the product shall be originating in a Party if it satisfies one of the alternatives.
4. If a product is subject to a product-specific rule of origin that includes multiple requirements, the product shall be originating in a Party only if it satisfies all of the requirements.
5. For the purposes of this Annex and Annex ORIG-2 [Product-specific rules of origin], the following definitions apply:
  - (a) 'section' means a section of the Harmonised System;
  - (b) 'Chapter' means the first two-digits in the tariff classification number under the Harmonised System;
  - (c) 'heading' means the first four-digits in the tariff classification number under the Harmonised System; and
  - (d) 'subheading' means the first six-digits in the tariff classification number under the Harmonised System.



2. For the purposes of the product-specific rules of origin, the following abbreviations apply:

‘CC’ means production from non-originating materials of any Chapter, except that of the product; this means that any non-originating material used in the production of the product must be classified in a Chapter (2-digit level of the Harmonised System) other than that of the product (i.e. a change in Chapter);

‘CTH’ means production from non-originating materials of any heading, except that of the product; this means that any non-originating material used in the production of the product must be classified in a heading (4-digit level of the Harmonised System) other than that of the product (i.e. a change in heading);

‘CTSH’ means production from non-originating materials of any subheading, except that of the product; this means that any non-originating material used in the production of the product must be classified in a subheading (6-digit level of the Harmonised System) other than that of the product (i.e. a change in sub-heading).

#### Note 3

##### Application of the Product-specific Rules of Origin

1. Article ORIG.3(2) [General requirements] of this Agreement, concerning products having acquired originating status which are used in the production of other products, applies whether or not this status has been acquired inside the same factory in a Party where these products are used.

2. If a product-specific rule of origin specifically excludes certain non-originating material or provides that the value or weight of a specified non-originating material shall not exceed a specific threshold, these conditions do not apply to non-originating materials classified elsewhere in the Harmonised System.

3. Example 1: when the rule for bulldozers (HS sub-heading 8429.11) requires: “CTH except from non-originating materials of heading 84.31 parts suitable solely for machinery of heading 84.25 to 84.30”, the use of non-originating materials classified elsewhere than 84.29 and 84.31- such as screws (HS heading 73.18), insulated wires and electric conductors (HS heading 85.44) and various electronics (HS Chapter 85) - is not limited.

Example 2: When the rule for heading 35.05 (dextrins and other modified starches; glues based on starches etc) requires ‘CTH except from non-originating heading 11.08’ then the use of non-originating materials classified elsewhere than 11.08 (starches, inulin), such as materials of Chapter 10 (cereals), is not limited.

4. If a product-specific rule of origin provides that a product shall be produced from a particular material, this does not prevent the use of other materials which are unable to satisfy that rule because of their inherent nature.

#### Note 4

##### Calculation of a maximum value of non-originating materials

For the purposes of the product-specific rules of origin, the following definitions apply:

- (a) "customs value" means the value as determined in accordance with the Agreement on Implementation of Article VII of GATT 1994;
- (b) "EXW" or "ex-works price" means:
- (i) the price of the product paid or payable to the producer in whose undertaking the last working or processing is carried out, provided that the price includes the value of all the materials used and all other costs incurred in the production of the product, minus any internal taxes which are, or may be, repaid when the product obtained is exported; or
  - (ii) if there is no price paid or payable or if the actual price paid does not reflect all costs related to the production of the product which are actually incurred in the production of the product, the value of all the materials used and all other costs incurred in the production of the product in the exporting Party:
    - (A) including selling, general and administrative expenses, as well as profit, that can reasonably be allocated to the product; and
    - (B) excluding the cost of freight, insurance, all other costs incurred in transporting the product and any internal taxes of the exporting Party which are, or may be, repaid when the product obtained is exported.
  - (iii) For the purposes of point (i), where the last production has been contracted to a producer, the term 'producer' in point (i) refers to the person who has employed the subcontractor.
- (c) "MaxNOM" means the maximum value of non-originating materials expressed as a percentage and shall be calculated according to the following formula:

$$\text{MaxNOM (\%)} = \frac{\text{VNM}}{\text{EXW}} \times 100$$

- (d) "VNM" means the value of the non-originating materials used in the production of the product, which is its customs value at the time of importation, including freight, insurance if appropriate, packing and all other costs incurred in transporting the materials to the importation port in the Party where the producer of the product is located; where the value of the non-originating materials is not known and cannot be ascertained, the first ascertainable price paid for the non-originating materials in the Union or in the United Kingdom is used; the value of the non-originating materials used in the production of the product may be calculated on the basis of the weighted average value formula or other inventory valuation method under accounting principles which are generally accepted in the Party.

Note 5

Definitions of processes referred to in Sections V to VII in Annex ORIG-2 [Product-specific rules of origin]

For the purposes of product-specific rules of origin, the following definitions apply:

- (a) 'biotechnological processing' means:
  - (i) biological or biotechnological culturing (including cell culture), hybridisation or genetic modification of micro-organisms (bacteria, viruses (including phages) etc.) or human, animal or plant cells; and
  - (ii) production, isolation or purification of cellular or intercellular structures (such as isolated genes, gene fragments and plasmids), or fermentation;
- (b) 'change in particle size' means the deliberate and controlled modification in particle size of a product, other than by merely crushing or pressing, resulting in a product with a defined particle size, defined particle size distribution or defined surface area, which is relevant to the purposes of the resulting product and with physical or chemical characteristics different from those of the input materials;
- (c) 'chemical reaction' means a process (including a biochemical processing) which results in a molecule with a new structure by breaking intramolecular bonds and by forming new intramolecular bonds, or by altering the spatial arrangement of atoms in a molecule, with the exception of the following, which are not considered to be chemical reactions for the purpose of this definition:
  - (i) dissolving in water or other solvents;
  - (ii) the elimination of solvents including solvent water; or
  - (iii) the addition or elimination of water of crystallisation;
- (d) 'distillation' means:
  - (i) atmospheric distillation: a separation process in which petroleum oils are converted, in a distillation tower, into fractions according to boiling point and the vapour then condensed into different liquefied fractions; products produced from petroleum distillation may include liquefied petroleum gas, naphtha, gasoline, kerosene, diesel or heating oil, light gas oils and lubricating oil; and
  - (ii) vacuum distillation: distillation at a pressure below atmospheric but not so low that it would be classed as molecular distillation; vacuum distillation is used for distilling high-boiling and heat-sensitive materials such as heavy distillates in petroleum oils to produce light to heavy vacuum gas oils and residuum;
- (e) 'isomer separation' means the isolation or separation of isomers from a mixture of isomers;
- (f) 'mixing and blending' means the deliberate and proportionally controlled mixing or blending (including dispersing) of materials, other than the addition of diluents, only to conform to predetermined specifications which results in the production of a product having physical or chemical characteristics that are relevant to the purposes or uses of the product and are different from the input materials;

- (g) 'production of standard materials' (including standard solutions) means a production of a preparation suitable for analytical, calibrating or referencing uses with precise degrees of purity or proportions certified by the producer; and
- (h) 'purification' means a process which results in the elimination of at least 80 % of the content of existing impurities or the reduction or elimination of impurities resulting in a good suitable for one or more of the following applications:
  - (i) pharmaceutical, medical, cosmetic, veterinary or food grade substances;
  - (ii) chemical products and reagents for analytical, diagnostic or laboratory uses;
  - (iii) elements and components for use in micro-electronics;
  - (iv) specialised optical uses;
  - (v) biotechnical use, for example, in cell culturing, in genetic technology or as a catalyst;
  - (vi) carriers used in a separation process; or
  - (vii) nuclear grade uses.

#### Note 6

#### Definitions of terms used in Section XI of Annex ORIG-2 [Product-specific rules of origin]

For the purposes of the product-specific rules of origin, the following definitions apply:

- (a) 'man-made staple fibres' means synthetic or artificial filament tow, staple fibres or waste, of headings 55.01 to 55.07;
- (b) 'natural fibres' means fibres other than synthetic or artificial fibres, the use of which is restricted to the stages before spinning takes place, including waste, and, unless otherwise specified, includes fibres which have been carded, combed or otherwise processed, but not spun; 'natural fibres' includes horsehair of heading 05.11, silk of headings 50.02 and 50.03, wool-fibres and fine or coarse animal hair of headings 51.01 to 51.05, cotton fibres of headings 52.01 to 52.03, and other vegetable fibres of headings 53.01 to 53.05;
- (c) 'printing' means a technique by which an objectively assessed function, such as colour, design, or technical performance, is given to a textile substrate with a permanent character, using screen, roller, digital or transfer techniques; and
- (d) 'printing (as standalone operation)' means a technique by which an objectively assessed function, such as colour, design, or technical performance, is given to a textile substrate with a permanent character, using screen, roller, digital or transfer techniques combined with at least two preparatory or finishing operations (such as scouring, bleaching, mercerizing, heat setting, raising, calendaring, shrink resistance processing, permanent finishing, decatizing, impregnating, mending and burling, shearing, singeing, process of air-tumbler, process of stenter, milling, steam and shrinking, and wet decatizing), provided that the value of all the non-originating materials used does not exceed 50 % of the EXW of the product.

## Note 7

### Tolerances applicable to products containing two or more basic textile materials

1. For the purposes of this Note, basic textile materials are the following:

- (a) silk;
- (b) wool;
- (c) coarse animal hair;
- (d) fine animal hair;
- (e) horsehair;
- (f) cotton;
- (g) paper-making materials and paper;
- (h) flax;
- (i) true hemp;
- (j) jute and other textile bast fibres;
- (k) sisal and other textile fibres of the genus *Agave*;
- (l) coconut, abaca, ramie and other vegetable textile fibres;
- (m) synthetic man-made filaments;
- (n) artificial man-made filaments;
- (o) current-conducting filaments; uth
- (p) synthetic man-made staple fibres of polypropylene;
- (q) synthetic man-made staple fibres of polyester;
- (r) synthetic man-made staple fibres of polyamide;
- (s) synthetic man-made staple fibres of polyacrylonitrile;
- (t) synthetic man-made staple fibres of polyimide;
- (u) synthetic man-made staple fibres of polytetrafluoroethylene;
- (v) synthetic man-made staple fibres of poly (phenylene sulphide);
- (w) synthetic man-made staple fibres of poly (vinyl chloride);

- (x) other synthetic man-made staple fibres;
- (y) artificial man-made staple fibres of viscose;
- (z) other artificial man-made staple fibres;
- (aa) yarn made of polyurethane segmented with flexible segments of polyether, whether or not gimped;
- (bb) yarn made of polyurethane segmented with flexible segments of polyester whether or not gimped;
- (cc) products of heading 56.05 (metallised yarn) incorporating strip consisting of a core of aluminium foil or of a core of plastic film irrespective of whether or not coated with aluminium powder, of a width not exceeding 5 mm, sandwiched by means of a transparent or coloured adhesive between two layers of plastic film;
- (dd) other products of heading 56.05;
- (ee) glass fibres; and
- (ff) metal fibres.

2. Where reference to this Note is made in Annex ORIG-2 [Product-specific rules of origin], the requirements set out in its Column 2 shall not apply, as a tolerance, to non-originating basic textile materials which are used in the production of a product, provided that:

- (a) the product contains two or more basic textile materials; and
- (b) the weight of the non-originating basic textile materials, taken together, does not exceed 10 % of the total weight of all the basic textile materials used.

Example: For a woollen fabric of heading 51.12 containing woollen yarn of heading 51.07, synthetic yarn of staple fibres of heading 55.09 and materials other than basic textile materials, non-originating woollen yarn which does not satisfy the requirement set out in Annex ORIG-2 [Product-specific rules of origin], or non-originating synthetic yarn which does not satisfy the requirement set out in Annex ORIG-2 [Product-specific rules of origin], or a combination of both, may be used, provided that their total weight does not exceed 10 % of the weight of all the basic textile materials.

3. Notwithstanding Note 7.2 (b), for products containing 'yarn made of polyurethane segmented with flexible segments of polyether, whether or not gimped', the maximum tolerance is 20 %. However, the percentage of the other non-originating basic textile materials shall not exceed 10 %.

4. Notwithstanding Note 7.2 (b), for products containing 'strip consisting of a core of aluminium foil or of a core of plastic film irrespective of whether or not coated with aluminium powder, of a width not exceeding 5 mm, sandwiched by means of a transparent or coloured adhesive between two layers of plastic film, the maximum tolerance is 30 %. However, the percentage of the other non-originating basic textile materials shall not exceed 10 %.

Note 8

429

## Other tolerances applicable to certain textile products

1. Where reference to this Note is made in Annex ORIG-2 [Product-specific rules of Origin], non-originating textile materials (with the exception of linings and interlinings) which do not satisfy the requirements set out in its Column 2 for a made-up textile product may be used, provided that they are classified in a heading other than that of the product and that their value does not exceed 8 % of the EXW of the product.

2. Non-originating materials which are not classified in Chapters 50 to 63 may be used without restriction in the production of textile products classified in Chapters 50 to 63, whether or not they contain textiles.

Example: If a requirement set out in Annex ORIG-2 [Product-specific rules of origin] provides that yarn shall be used, for a certain textile item (such as trousers), this does not prevent the use of non-originating metal items (such as buttons), because metal items are not classified in Chapters 50 to 63. For the same reasons, it does not prevent the use of non-originating slide fasteners, even though slide-fasteners normally contain textiles.

3. Where a requirement set out in Annex ORIG-2 [Product-specific rules of origin] consists in a maximum value of non-originating materials, the value of the non-originating materials which are not classified in Chapters 50 to 63 shall be taken into account in the calculation of the value of the non-originating materials.

### Note 9

#### Agricultural Products

Agricultural products classified under Section II of the Harmonised System and heading 24.01, which are grown or harvested in the territory of a Party, shall be treated as originating in the territory of that Party, even if grown from seeds, bulbs, rootstock, cuttings, slips, grafts, shoots, buds, or other live parts of plants imported from a third country.

ANNEX ORIG-2: PRODUCT SPECIFIC RULES OF ORIGIN

<b>Column 1</b>	<b>Column 2</b>
<b>Harmonised System classification (2017) including specific description</b>	<b>Product-specific rule of origin</b>
<b>SECTION I</b>	<b>LIVE ANIMALS; ANIMAL PRODUCTS</b>
<b>Chapter 1</b>	<b>Live animals</b>
01.01-01.06	All animals of Chapter 1 are wholly obtained.
<b>Chapter 2</b>	<b>Meat and edible meat offal</b>
02.01-02.10	Production in which all the materials of Chapters 1 and 2 used are wholly obtained.
<b>Chapter 3</b>	<b>Fish and crustaceans, molluscs and other aquatic invertebrates</b>
03.01-03.08	Production in which all the materials of Chapter 3 used are wholly obtained.
<b>Chapter 4</b>	<b>Dairy produce; birds' eggs; natural honey; edible products of animal origin, not elsewhere specified or included</b>
04.01-04.10	Production in which:  - all the materials of Chapter 4 used are wholly obtained; and  - the total weight of non-originating materials of headings 17.01 and 17.02 does not exceed 20 % of the weight of the product.
<b>Chapter 5</b>	<b>Products of animal origin, not elsewhere specified or included</b>
05.01-05.11	Production from non-originating materials of any heading.
<b>SECTION II</b>	<b>VEGETABLE PRODUCTS</b>
<b>Chapter 6</b>	<b>Live trees and other plants; bulbs, roots and the like; cut flowers and ornamental foliage</b>
06.01-06.04	Production in which all the materials of Chapter 6 used are wholly obtained.
<b>Chapter 7</b>	<b>Edible vegetables and certain roots and tubers</b>
07.01-07.14	Production in which all the materials of Chapter 7 used are wholly obtained.
<b>Chapter 8</b>	<b>Edible fruit and nuts; peel of citrus fruit or melons</b>



08.01-08.14	Production in which:  - all the materials of Chapter 8 used are wholly obtained; and  - the total weight of non-originating materials of headings 17.01 and 17.02 does not exceed 20 % of the weight of the product.
<b>Chapter 9</b>	<b>Coffee, tea, maté and spices</b>
09.01-09.10	Production from non-originating materials of any heading.
<b>Chapter 10</b>	<b>Cereals</b>
10.01-10.08	Production in which all the materials of Chapter 10 used are wholly obtained.
<b>Chapter 11</b>	<b>Products of the milling industry; malt; starches; inulin; wheat gluten</b>
11.01-11.09	Production in which all materials of Chapters 10 and 11, headings 07.01, 07.14, 23.02 to 23.03 or subheading 0710.10 used are wholly obtained.
<b>Chapter 12</b>	<b>Oil seeds and oleaginous fruits; miscellaneous grains, seeds and fruit; industrial or medicinal plants; straw and fodder</b>
12.01-12.14	CTH
<b>Chapter 13</b>	<b>Lac; gums, resins and other vegetable saps and extracts</b>
13.01-13.02	Production from non-originating materials of any heading in which the total weight of non-originating materials of headings 17.01 and 17.02 does not exceed 20 % of the weight of the product.
<b>Chapter 14</b>	<b>Vegetable plaiting materials; vegetable products not elsewhere specified or included</b>
14.01-14.04	Production from non-originating materials of any heading.
<b>SECTION III</b>	<b>ANIMAL OR VEGETABLE FATS AND OILS AND THEIR CLEAVAGE PRODUCTS; PREPARED EDIBLE FATS; ANIMAL OR VEGETABLE WAXES</b>
<b>Chapter 15</b>	<b>Animal or vegetable fats and oils and their cleavage products; prepared edible fats; animal or vegetable waxes</b>
15.01-15.04	CTH
15.05-15.06	Production from non-originating materials of any heading.
15.07-15.08	CTSH
15.09-15.10	Production in which all the vegetable materials used are wholly obtained.
15.11-15.15	CTSH

15.16-15.17	CTH
15.18-15.19	CTSH
15.20	Production from non-originating materials of any heading.
15.21-15.22	CTSH
<b>SECTION IV</b>	<b>PREPARED FOODSTUFFS; BEVERAGES, SPIRITS AND VINEGAR; TOBACCO AND MANUFACTURED TOBACCO SUBSTITUTES</b>
<b>Chapter 16</b>	<b>Preparations of meat, of fish or of crustaceans, molluscs or other aquatic invertebrates</b>
1601.00-1604.18	Production in which all the materials of Chapters 1, 2, 3 and 16 used are wholly obtained <sup>88</sup> .
1604.19	CC
1604.20	
- Preparations of surimi:	CC
- Others:	Production in which all the materials of Chapters 3 and 16 used are wholly obtained <sup>89</sup> .
1604.31-1605.69	Production in which all the materials of Chapters 3 and 16 used are wholly obtained.
<b>Chapter 17</b>	<b>Sugars and sugar confectionery</b>
17.01	CTH
17.02	CTH, provided that the total weight of non-originating materials of headings 11.01 to 11.08, 17.01 and 17.03 used does not exceed 20 % of the weight of the product.
17.03	CTH

---

88 Prepared or preserved tunas, skipjack and bonito (*Sarda spp.*), whole or in pieces (excl. minced) classified in subheading 1604.14 may qualify as originating under alternative product-specific rules of origin within annual quotas as specified in Annex ORIG-2A [Origin quotas and alternatives to the product-specific rules of origin in Annex ORIG-2].

89 Prepared or preserved tunas, skipjack or other fish of genus *Euthynnus* (excl. whole or in pieces) classified in subheading 1604.20 may qualify as originating under alternative product-specific rules of origin within annual quotas as specified in Annex ORIG-2A [Origin quotas and alternatives to the product-specific rules of origin in Annex ORIG-2].

17.04	
- White chocolate:	<p>CTH, provided that:</p> <p>(a) all the materials of Chapter 4 used are wholly obtained; and</p> <p>(b) (i) the total weight of non-originating materials of headings 17.01 and 17.02 used does not exceed 40 % of the weight of the product; or</p> <p>(ii) the value of non-originating materials of headings 17.01 and 17.02 used does not exceed 30 % of the ex-works price of the product.</p>
- Others:	<p>CTH, provided that:</p> <p>- all the materials of Chapter 4 used are wholly obtained; and</p> <p>- the total weight of non-originating materials of headings 17.01 and 17.02 used does not exceed 40 % of the weight of the product.</p>
<b>Chapter 18</b>	<b>Cocoa and cocoa preparations</b>
18.01-18.05	CTH
1806.10	<p>CTH, provided that:</p> <p>- all the materials of Chapter 4 used are wholly obtained; and</p> <p>- the total weight of non-originating materials of headings 17.01 and 17.02 used does not exceed 40 % of the weight of the product.</p>
1806.20-1806.90	<p>CTH, provided that:</p> <p>(a) all the materials of Chapter 4 used are wholly obtained; and</p> <p>(b) (i) the total weight of non-originating materials of headings 17.01 and 17.02 used does not exceed 40 % of the weight of the product; or</p> <p>(ii) the value of non-originating materials of headings 17.01 and 17.02 used does not exceed 30 % of the ex-works price of the product.</p>
<b>Chapter 19</b>	<b>Preparations of cereals, flour, starch or milk; pastrycooks' products</b>
19.01-19.05	<p>CTH, provided that:</p> <p>- all the materials of Chapter 4 used are wholly obtained;</p> <p>- the total weight of non-originating materials of Chapters 2, 3 and 16 used does not exceed 20 % of the weight of the product;</p> <p>- the total weight of non-originating materials of headings 10.06 and 11.08 used</p>

	<p>does not exceed 20 % of the weight of the product; and</p> <p>- the total weight of non-originating materials of headings 17.01 and 17.02 used does not exceed 40 % of the weight of the product.</p>
<b>Chapter 20</b>	<b>Preparations of vegetables, fruit, nuts or other parts of plants</b>
20.01	CTH
20.02-20.03	Production in which all the materials of Chapter 7 used are wholly obtained.
20.04-20.09	CTH, provided that the total weight of non-originating materials of headings 17.01 and 17.02 used does not exceed 40 % of the weight of the product.
<b>Chapter 21</b>	<b>Miscellaneous edible preparations</b>
21.01-21.02	<p>CTH, provided that:</p> <p>- all the materials of Chapter 4 used are wholly obtained; and</p> <p>- the total weight of non-originating materials of headings 17.01 and 17.02 used does not exceed 20 % of the weight of the product.</p>
2103.10 2103.20 2103.90	CTH; however, non-originating mustard flour or meal or prepared mustard may be used.
2103.30	Production from non-originating materials of any heading.
21.04-21.06	<p>CTH, provided that:</p> <p>- all the materials of Chapter 4 used are wholly obtained; and</p> <p>- the total weight of non-originating materials of headings 17.01 and 17.02 used does not exceed 20 % of the weight of the product.</p>
<b>Chapter 22</b>	<b>Beverages, spirits and vinegar</b>
22.01-22.06	<p>CTH except from non-originating materials of headings 22.07 and 22.08, provided that:</p> <p>- all the materials of subheadings 0806.10, 2009.61, 2009.69 used are wholly obtained;</p> <p>- all the materials of Chapter 4 used are wholly obtained; and</p> <p>- the total weight of non-originating materials of headings 17.01 and 17.02 used does not exceed 20 % of the weight of the product.</p>
22.07	CTH except from non-originating materials of heading 22.08, provided that all the

	materials of Chapter 10, subheadings 0806.10, 2009.61 and 2009.69 used are wholly obtained.
22.08-22.09	CTH except from non-originating materials of headings 22.07 and 22.08, provided that all the materials of subheadings 0806.10, 2009.61 and 2009.69 used are wholly obtained.
<b>Chapter 23</b>	<b>Residues and waste from the food industries; prepared animal fodder</b>
23.01	CTH
2302.10-2303.10	CTH, provided that the total weight of non-originating materials of Chapter 10 used does not exceed 20 % of the weight of the product.
2303.20-2308.00	CTH
23.09	CTH, provided that: <ul style="list-style-type: none"> <li>- all the materials of Chapters 2 and 4 used are wholly obtained;</li> <li>- the total weight of non-originating materials of headings 10.01 to 10.04, 10.07 to 10.08, Chapter 11, and headings 23.02 and 23.03 used does not exceed 20 % of the weight of the product; and</li> <li>- the total weight of non-originating materials of headings 17.01 and 17.02 used does not exceed 20 % of the weight of the product.</li> </ul>
<b>Chapter 24</b>	<b>Tobacco and manufactured tobacco substitutes</b>
24.01	Production in which all materials of heading 24.01 are wholly obtained.
2402.10	Production from non-originating materials of any heading, provided that the total weight of non-originating materials of heading 24.01 used does not exceed 30 % of the weight of materials of Chapter 24 used.
2402.20	Production from non-originating materials of any heading, except that of the product and of smoking tobacco of subheading 2403.19, and in which at least 10 % by weight of all materials of heading 24.01 used is wholly obtained.
2402.90	Production from non-originating materials of any heading, provided that the total weight of non-originating materials of heading 24.01 used does not exceed 30 % of the weight of materials of Chapter 24 used.
24.03	CTH, in which at least 10 % by weight of all materials of heading 24.01 used are wholly obtained.
<b>SECTION V</b>	<b>MINERAL PRODUCTS</b>  <b>Section note: For definitions of horizontal processing rules within this Section, see Note 5 of Annex ORIG-1</b>

<b>Chapter 25</b>	<b>Salt; sulphur; earths and stone; plastering materials, lime and cement</b>
25.01-25.30	CTH;  or  MaxNOM 70 % (EXW).
<b>Chapter 26</b>	<b>Ores, slag and ash</b>
26.01-26.21	CTH
<b>Chapter 27</b>	<b>Mineral fuels, mineral oils and products of their distillation; bituminous substances; mineral waxes</b>
27.01-27.09	Production from non-originating materials of any heading.
27.10	CTH except from non-originating biodiesel of subheading 3824.99 or 3826.00;  or  Distillation or a chemical reaction is undergone, provided that biodiesel (including hydrotreated vegetable oil) of heading 27.10 and subheadings 3824.99 and 3826.00 used is obtained by esterification, transesterification or hydrotreatment.
27.11-27.15	Production from non-originating materials of any heading.
<b>SECTION VI</b>	<b>PRODUCTS OF THE CHEMICAL OR ALLIED INDUSTRIES</b>  <b>Section note: For definitions of horizontal processing rules within this Section, see Note 5 of Annex ORIG-1</b>
<b>Chapter 28</b>	<b>Inorganic chemicals; organic or inorganic compounds of precious metals, of rare-earth metals, of radioactive elements or of isotopes</b>
28.01-28.53	CTSH;  A chemical reaction, purification, mixing and blending, production of standard materials, a change in particle size, isomer separation, or biotechnological processing is undergone;  or  MaxNOM 50 % (EXW).
<b>Chapter 29</b>	<b>Organic chemicals</b>
2901.10-2905.42	CTSH;  A chemical reaction, purification, mixing and blending, production of standard materials, a change in particle size, isomer separation, or biotechnological

	<p>processing is undergone;</p> <p>or</p> <p>MaxNOM 50 % (EXW).</p>
2905.43-2905.44	CTH except from non-originating materials of heading 17.02 and subheading 3824.60.
2905.45	<p>CTSH, however, non-originating materials of the same sub-heading as the product may be used, provided that their total value does not exceed 20 % of the ex-works price of the product;</p> <p>or</p> <p>MaxNOM 50 % (EXW).</p>
2905.49-2942	<p>CTSH;</p> <p>A chemical reaction, purification, mixing and blending, production of standard materials, a change in particle size, isomer separation, or biotechnological processing is undergone;</p> <p>or</p> <p>MaxNOM 50 % (EXW).</p>
<b>Chapter 30</b>	<b>Pharmaceutical products</b>
30.01-30.06	<p>CTSH;</p> <p>A chemical reaction, purification, mixing and blending, production of standard materials, a change in particle size, isomer separation, or biotechnological processing is undergone;</p> <p>or</p> <p>MaxNOM 50 % (EXW).</p>
<b>Chapter 31</b>	<b>Fertilisers</b>
31.01-31.04	<p>CTH, however, non-originating materials of the same heading as the product may be used, provided that their total value does not exceed 20 % of the EXW of the product;</p> <p>or</p> <p>MaxNOM 40 % (EXW).</p>
31.05	
-Sodium nitrate	CTH, however, non-originating materials of the same heading as the product may

-Calcium cyanamide  -Potassium sulphate  -Magnesium potassium sulphate	be used, provided that their total value does not exceed 20 % of the EXW of the product;  or  MaxNOM 40 % (EXW).
-Others	CTH, however, non-originating materials of the same heading as the product may be used, provided that their total value does not exceed 20 % of the EXW of the product, and in which the value of all non-originating materials used does not exceed 50% of the EXW of the product;  or  MaxNOM 40 % (EXW).
<b>Chapter 32</b>	<b>Tanning or dyeing extracts; tannins and their derivatives; dyes, pigments and other colouring matter; paints and varnishes; putty and other mastics; inks</b>
32.01-32.15	CTSH;  A chemical reaction, purification, mixing and blending, production of standard materials, a change in particle size, isomer separation, or biotechnological processing is undergone;  or  MaxNOM 50 % (EXW).
<b>Chapter 33</b>	<b>Essential oils and resinoids; perfumery, cosmetic or toilet preparations</b>
33.01	CTSH;  A chemical reaction, purification, mixing and blending, production of standard materials, a change in particle size, isomer separation, or biotechnological processing is undergone;  or  MaxNOM 50 % (EXW).
3302.10	CTH, however, non-originating materials of subheading 3302.10 may be used, provided that their total value does not exceed 20 % of the EXW of the product.
3302.90	CTSH;  A chemical reaction, purification, mixing and blending, production of standard materials, a change in particle size, isomer separation, or biotechnological processing is undergone;



	or MaxNOM 50 % (EXW).
33.03	Production from non-originating materials of any heading.
33.04 -33.07	CTSH;  A chemical reaction, purification, mixing and blending, production of standard materials, a change in particle size, isomer separation, or biotechnological processing is undergone;  or  MaxNOM 50 % (EXW).
<b>Chapter 34</b>	<b>Soap, organic surface-active agents, washing preparations, lubricating preparations, artificial waxes, prepared waxes, polishing or scouring preparations, candles and similar articles, modelling pastes, "dental waxes" and dental preparations with a basis of plaster</b>
34.01-34.07	CTSH;  A chemical reaction, purification, mixing and blending, production of standard materials, a change in particle size, isomer separation, or biotechnological processing is undergone;  or  MaxNOM 50 % (EXW).
<b>Chapter 35</b>	<b>Albuminoidal substances; modified starches; glues; enzymes</b>
35.01-35.04	CTH except from non-originating materials of Chapter 4.
35.05	CTH except from non-originating materials of heading 11.08.
35.06-35.07	CTSH;  A chemical reaction, purification, mixing and blending, production of standard materials, a change in particle size, isomer separation, or biotechnological processing is undergone;  or  MaxNOM 50 % (EXW).
<b>Chapter 36</b>	<b>Explosives; pyrotechnic products; matches; pyrophoric alloys; certain combustible preparations</b>
36.01-36.06	CTSH;

	<p>A chemical reaction, purification, mixing and blending, production of standard materials, a change in particle size, isomer separation, or biotechnological processing is undergone;</p> <p>or</p> <p>MaxNOM 50 % (EXW).</p>
<b>Chapter 37</b>	<b>Photographic or cinematographic goods</b>
37.01-37.07	<p>CTSH;</p> <p>A chemical reaction, purification, mixing and blending, production of standard materials, a change in particle size, isomer separation, or biotechnological processing is undergone;</p> <p>or</p> <p>MaxNOM 50 % (EXW).</p>
<b>Chapter 38</b>	<b>Miscellaneous chemical products</b>
38.01-38.08	<p>CTSH;</p> <p>A chemical reaction, purification, mixing and blending, production of standard materials, a change in particle size, isomer separation, or biotechnological processing is undergone;</p> <p>or</p> <p>MaxNOM 50 % (EXW).</p>
3809.10	CTH except from non-originating materials of headings 11.08 and 35.05.
3809.91-3822.00	<p>CTSH;</p> <p>A chemical reaction, purification, mixing and blending, production of standard materials, a change in particle size, isomer separation, or biotechnological processing is undergone;</p> <p>or</p> <p>MaxNOM 50 % (EXW).</p>
38.23	Production from non-originating material of any heading.
3824.10-3824.50	<p>CTSH;</p> <p>A chemical reaction, purification, mixing and blending, production of standard materials, a change in particle size, isomer separation, or biotechnological processing is undergone;</p>

	<p>or</p> <p>MaxNOM 50 % (EXW).</p>
3824.60	CTH except from non-originating materials of subheadings 2905.43 and 2905.44.
3824.71-3825.90	<p>CTSH;</p> <p>A chemical reaction, purification, mixing and blending, production of standard materials, a change in particle size, isomer separation, or biotechnological processing is undergone;</p> <p>or</p> <p>MaxNOM 50 % (EXW).</p>
38.26	Production in which biodiesel is obtained through transesterification, esterification or hydro-treatment.
<b>SECTION VII</b>	<p><b>PLASTICS AND ARTICLES THEREOF; RUBBER AND ARTICLES THEREOF</b></p> <p><b>Section note: For definitions of horizontal processing rules within this Section, see Note 5 of Annex ORIG-1</b></p>
<b>Chapter 39</b>	<b>Plastics and articles thereof</b>
39.01-39.15	<p>CTSH;</p> <p>A chemical reaction, purification, mixing and blending, production of standard materials, a change in particle size, isomer separation, or biotechnological processing is undergone;</p> <p>or</p> <p>MaxNOM 50 % (EXW).</p>
39.16-39.19	<p>CTH;</p> <p>or</p> <p>MaxNOM 50 % (EXW).</p>
39.20	<p>CTSH;</p> <p>or</p> <p>MaxNOM 50 % (EXW).</p>
39.21-39.22	<p>CTH;</p> <p>or</p>

	MaxNOM 50 % (EXW).
3923.10-3923.50	CTSH;  or  MaxNOM 50 % (EXW).
3923.90-3925.90	CTH;  or  MaxNOM 50 % (EXW).
39.26	CTSH;  or  MaxNOM 50 % (EXW).
<b>Chapter 40</b>	<b>Rubber and articles thereof</b>
40.01 - 40.11	CTH;  or  MaxNOM 50 % (EXW).
4012.11-4012.19	CTSH;  or  Retreading of used tyres.
4012.20-4017.00	CTH;  or  MaxNOM 50 % (EXW).
<b>SECTION VIII</b>	<b>RAW HIDES AND SKINS, LEATHER, FURSKINS AND ARTICLES THEREOF; SADDLERY AND HARNESS; TRAVEL GOODS, HANDBAGS AND SIMILAR CONTAINERS; ARTICLE OF ANIMAL GUT (OTHER THAN SILK-WORM GUT)</b>
<b>Chapter 41</b>	<b>Raw hides and skins (other than furskins) and leather</b>
41.01-4104.19	CTH
4104.41-4104.49	CTSH except from non-originating materials of subheadings 4104.41 to 4104.49.
4105.10	CTH

4105.30	CTSH
4106.21	CTH
4106.22	CTSH
4106.31	CTH
4106.32-4106.40	CTSH
4106.91	CTH
4106.92	CTSH
41.07-41.13	CTH except from non-originating materials of subheadings 4104.41, 4104.49, 4105.30, 4106.22, 4106.32 and 4106.92. However, non-originating materials of subheadings 4104.41, 4104.49, 4105.30, 4106.22, 4106.32 or 4106.92 may be used provided that they undergo a retanning operation.
4114.10	CTH
4114.20	CTH except from non-originating materials of subheadings 4104.41, 4104.49, 4105.30, 4106.22, 4106.32, 4106.92 and 4107. However, non-originating materials of subheadings 4104.41, 4104.49, 4105.30, 4106.22, 4106.32, 4106.92 and heading 41.07 may be used provided that they undergo a retanning operation.
41.15	CTH
<b>Chapter 42</b>	<b>Articles of leather; saddlery and harness; travel goods, handbags and similar containers; articles of animal gut (other than silk-worm gut)</b>
42.01-42.06	CTH; or MaxNOM 50 % (EXW).
<b>Chapter 43</b>	<b>Furskins and artificial fur; manufactures thereof</b>
4301.10-4302.20	CTH; or MaxNOM 50 % (EXW).
4302.30	CTSH
43.03-43.04	CTH; or

	MaxNOM 50 % (EXW).
<b>SECTION IX</b>	<b>WOOD AND ARTICLES OF WOOD; WOOD CHARCOAL; CORK AND ARTICLES OF CORK; MANUFACTURES OF STRAW, OF ESPARTO OR OTHER PLAITING MATERIALS; BASKETWARE AND WICKERWORK</b>
<b>Chapter 44</b>	<b>Wood and articles of wood; wood charcoal</b>
44.01-44.21	CTH;  or  MaxNOM 50 % (EXW).
<b>Chapter 45</b>	<b>Cork and articles of cork</b>
45.01-45.04	CTH;  or  MaxNOM 50 % (EXW).
<b>Chapter 46</b>	<b>Manufactures of straw, of esparto or of other plaiting materials; basketware and wickerwork</b>
46.01-46.02	CTH;  or  MaxNOM 50 % (EXW).
<b>SECTION X</b>	<b>PULP OF WOOD OR OF OTHER FIBROUS CELLULOSIC MATERIAL; RECOVERED (WASTE AND SCRAP) PAPER OR PAPERBOARD; PAPER AND PAPERBOARD AND ARTICLES THEREOF</b>
<b>Chapter 47</b>	<b>Pulp of wood or of other fibrous cellulosic material; recovered (waste and scrap) paper or paperboard</b>
47.01-47.07	CTH;  or  MaxNOM 50 % (EXW).
<b>Chapter 48</b>	<b>Paper and paperboard; articles of paper pulp, of paper or of paperboard</b>
48.01-48.23	CTH;  or  MaxNOM 50 % (EXW).

<b>Chapter 49</b>	<b>Printed books, newspapers, pictures and other products of the printing industry; manuscripts, typescripts and plans</b>
49.01-49.11	CTH;  or  MaxNOM 50 % (EXW).
<b>SECTION XI</b>	<b>TEXTILES AND TEXTILE ARTICLES</b>  <b>Section note: For definitions of terms used for tolerances applicable to certain products made of textile materials, see Notes 6,7 and 8 of Annex ORIG-1</b>
<b>Chapter 50</b>	<b>Silk</b>
50.01-50.02	CTH
50.03	
- Carded or combed:	Carding or combing of silk waste.
- Others:	CTH
50.04-50.05	Spinning of natural fibres;  Extrusion of man-made continuous filament combined with spinning;  Extrusion of man-made continuous filament combined with twisting;  or  Twisting combined with any mechanical operation.
50.06	
- Silk yarn and yarn spun from silk waste:	Spinning of natural fibres;  Extrusion of man-made continuous filament combined with spinning;  Extrusion of man-made continuous filament combined with twisting;

	<p>or</p> <p>Twisting combined with any mechanical operation.</p>
- Silk-worm gut:	CTH
50.07	<p>Spinning of natural or man-made staple fibres combined with weaving;</p> <p>Extrusion of man-made filament yarn combined with weaving;</p> <p>Twisting or any mechanical operation combined with weaving;</p> <p>Weaving combined with dyeing;</p> <p>Yarn dyeing combined with weaving;</p> <p>Weaving combined with printing;</p> <p>or</p> <p>Printing (as standalone operation).</p>
<b>Chapter 51</b>	<b>Wool, fine or coarse animal hair; horsehair yarn and woven fabric</b>
51.01-51.05	CTH
51.06-51.10	<p>Spinning of natural fibres;</p> <p>Extrusion of man-made fibres combined with spinning;</p> <p>or</p> <p>Twisting combined with any mechanical operation.</p>
51.11-51.13	<p>Spinning of natural or man-made staple fibres combined with weaving;</p> <p>Extrusion of man-made filament yarn combined with weaving;</p> <p>Weaving combined with dyeing;</p> <p>Yarn dyeing combined with weaving;</p> <p>Weaving combined with printing;</p> <p>or</p> <p>Printing (as standalone operation).</p>



<b>Chapter 52</b>	<b>Cotton</b>
52.01-52.03	CTH
52.04-52.07	Spinning of natural fibres; Extrusion of man-made fibres combined with spinning; or Twisting combined with any mechanical operation.
52.08-52.12	Spinning of natural or man-made staple fibres combined with weaving; Extrusion of man-made filament yarn combined with weaving; Twisting or any mechanical operation combined with weaving; Weaving combined with dyeing or with coating or with laminating; Yarn dyeing combined with weaving; Weaving combined with printing; or Printing (as standalone operation).
<b>Chapter 53</b>	<b>Other vegetable textile fibres; paper yarn and woven fabrics of paper yarn</b>
53.01-53.05	CTH
53.06-53.08	Spinning of natural fibres; Extrusion of man-made fibres combined with spinning; or Twisting combined with any mechanical operation.
53.09-53.11	Spinning of natural or man-made staple fibres combined with weaving; Extrusion of man-made filament yarn combined with weaving; Weaving combined with dyeing or with coating or with laminating; Yarn dyeing combined with weaving;

	Weaving combined with printing; or Printing (as standalone operation).
<b>Chapter 54</b>	<b>Man-made filaments; strip and the like of man-made textile materials</b>
54.01-54.06	Spinning of natural fibres; Extrusion of man-made fibres combined with spinning; or Twisting combined with any mechanical operation.
54.07-54.08	Spinning of natural or man-made staple fibres combined with weaving; Extrusion of man-made filament yarn combined with weaving; Yarn dyeing combined with weaving; Weaving combined with dyeing or with coating or with laminating; Twisting or any mechanical operation combined with weaving; Weaving combined with printing; or Printing (as standalone operation).
<b>Chapter 55</b>	<b>Man-made staple fibres</b>
55.01-55.07	Extrusion of man-made fibres.
55.08-55.11	Spinning of natural fibres; Extrusion of man-made fibres combined with spinning; or Twisting combined with any mechanical operation.
55.12-55.16	Spinning of natural or man-made staple fibres combined with weaving; Extrusion of man-made filament yarn combined with weaving; Twisting or any mechanical operation combined with weaving;

	<p>Weaving combined with dyeing or with coating or with laminating;</p> <p>Yarn dyeing combined with weaving;</p> <p>Weaving combined with printing;</p> <p>or</p> <p>Printing (as standalone operation).</p>
<b>Chapter 56</b>	<b>Wadding, felt and nonwovens; special yarns; twine, cordage, ropes and cables and articles thereof</b>
56.01	<p>Spinning of natural fibres;</p> <p>Extrusion of man-made fibres combined with spinning;</p> <p>Flocking combined with dyeing or with printing;</p> <p>or</p> <p>Coating, flocking, laminating, or metalizing combined with at least two other main preparatory or finishing operations (such as calendering, shrink-resistance processes, heat setting, permanent finishing), provided that the value of non-originating materials used does not exceed 50 % of the EXW of the product.</p>
56.02	
- Needleloom Felt:	<p>Extrusion of man-made fibres combined with fabric formation; however:</p> <ul style="list-style-type: none"> <li>- non-originating polypropylene filament of heading 54.02;</li> <li>- non-originating polypropylene fibres of heading 55.03 or 55.06; or</li> <li>- non-originating polypropylene filament tow of heading 55.01;</li> </ul> <p>of which the denomination in all cases of a single filament or fibre is less than 9 decitex, may be used, provided that their total value does not exceed 40 % of the EXW of the product;</p> <p>or</p> <p>Non-woven fabric formation alone in the case of felt made from natural fibres.</p>
- Others:	<p>Extrusion of man-made fibres combined with fabric formation;</p> <p>or</p> <p>Non-woven fabric formation alone in the case of other felt made from natural fibres.</p>

5603.11-5603.14	<p>Production from</p> <ul style="list-style-type: none"> <li>- directionally or randomly oriented filaments; or</li> <li>- substances or polymers of natural or man-made origin;</li> </ul> <p>followed in both cases by bonding into a nonwoven.</p>
5603.91-5603.94	<p>Production from</p> <ul style="list-style-type: none"> <li>- directionally or randomly oriented staple fibres; or</li> <li>- chopped yarns, of natural or man-made origin;</li> </ul> <p>followed in both cases by bonding into a nonwoven.</p>
5604.10	Production from rubber thread or cord, not textile covered.
5604.90	<p>Spinning of natural fibres;</p> <p>Extrusion of man-made fibres combined with spinning;</p> <p>or</p> <p>Twisting combined with any mechanical operation.</p>
56.05	<p>Spinning of natural or man-made staple fibres;</p> <p>Extrusion of man-made fibres combined with spinning;</p> <p>or</p> <p>Twisting combined with any mechanical operation.</p>
56.06	<p>Extrusion of man-made fibres combined with spinning;</p> <p>Twisting combined with gimping;</p> <p>Spinning of natural or man-made staple fibres;</p> <p>or</p> <p>Flocking combined with dyeing.</p>
56.07-56.09	<p>Spinning of natural fibres;</p> <p>or</p>

	Extrusion of man-made fibres combined with spinning.
<b>Chapter 57</b>	<b>Carpets and other textile floor coverings</b>  <b>Chapter note: For products of this Chapter non-originating jute fabric may be used as a backing.</b>
57.01-57.05	Spinning of natural or man-made staple fibres combined with weaving or with tufting;  Extrusion of man-made filament yarn combined with weaving or with tufting;  Production from coir yarn or sisal yarn or jute yarn or classical ring spun viscose yarn;  Tufting combined with dyeing or with printing;  Tufting or weaving of man-made filament yarn combined with coating or with laminating;  Flocking combined with dyeing or with printing;  or  Extrusion of man-made fibres combined with nonwoven techniques including needle punching.
<b>Chapter 58</b>	<b>Special woven fabrics; tufted textile fabrics; lace; tapestries; trimmings; embroidery</b>
58.01-58.04	Spinning of natural or man-made staple fibres combined with weaving or with tufting;  Extrusion of man-made filament yarn combined with weaving or with tufting;  Weaving combined with dyeing or with flocking or with coating or with laminating or with metalizing;  Tufting combined with dyeing or with printing;  Flocking combined with dyeing or with printing;  Yarn dyeing combined with weaving;  Weaving combined with printing;  or  Printing (as standalone operation).

58.05	CTH
58.06-58.09	<p>Spinning of natural or man-made staple fibres combined with weaving or with tufting;</p> <p>Extrusion of man-made filament yarn combined with weaving or with tufting;</p> <p>Weaving combined with dyeing or with flocking or with coating or with laminating or with metalizing;</p> <p>Tufting combined with dyeing or with printing;</p> <p>Flocking combined with dyeing or with printing;</p> <p>Yarn dyeing combined with weaving;</p> <p>Weaving combined with printing;</p> <p>or</p> <p>Printing (as standalone operation).</p>
58.10	Embroidering in which the value of non-originating materials of any heading, except that of the product, used does not exceed 50 % of the EXW of the product.
58.11	<p>Spinning of natural or man-made staple fibres combined with weaving or with tufting;</p> <p>Extrusion of man-made filament yarn combined with weaving or with tufting;</p> <p>Weaving combined with dyeing or with flocking or with coating or with laminating or with metalizing;</p> <p>Tufting combined with dyeing or with printing;</p> <p>Flocking combined with dyeing or with printing;</p> <p>Yarn dyeing combined with weaving;</p> <p>Weaving combined with printing;</p> <p>or</p> <p>Printing (as standalone operation).</p>
<b>Chapter 59</b>	<b>Impregnated, coated, covered or laminated textile fabrics; textile articles of a kind suitable for industrial use</b>

59.01	Weaving combined with dyeing or with flocking or with coating or with laminating or with metalising;  or  Flocking combined with dyeing or with printing.
59.02	
- Containing not more than 90 % by weight of textile materials:	Weaving.
- Others:	Extrusion of man-made fibres combined with weaving.
59.03	Weaving, knitting or crocheting combined with impregnating or with coating or with covering or with laminating or with metalising;  Weaving combined with printing; or  Printing (as standalone operation).
59.04	Calendaring combined with dyeing, coating, laminating or metalizing. Non-originating jute fabric may be used as a backing;  or  Weaving combined with dyeing or with coating or with laminating or with metalising. Non-originating jute fabric may be used as a backing.
59.05	
- Impregnated, coated, covered or laminated with rubber, plastics or other materials:	Weaving, knitting or non-woven fabric formation combined with impregnating or with coating or with covering or with laminating or with metalising.
- Others:	Spinning of natural or man-made staple fibres combined with weaving;  Extrusion of man-made filament yarn combined with weaving;  Weaving, knitting or nonwoven fabric formation combined with dyeing or with

	<p>coating or with laminating;</p> <p>Weaving combined with printing;</p> <p>or</p> <p>Printing (as standalone operation).</p>
59.06	
- Knitted or crocheted fabrics:	<p>Spinning of natural or man-made staple fibres combined with knitting or with crocheting;</p> <p>Extrusion of man-made filament yarn combined with knitting or with crocheting;</p> <p>Knitting or crocheting combined with rubberising; or</p> <p>Rubberising combined with at least two other main preparatory or finishing operations (such as calendering, shrink-resistance processes, heat setting, permanent finishing) provided that the value of non-originating materials used does not exceed 50 % of the EXW of the product.</p>
- Other fabrics made of synthetic filament yarn, containing more than 90 % by weight of textile materials:	<p>Extrusion of man-made fibres combined with weaving.</p>
- Others:	<p>Weaving, knitting or nonwoven process combined with dyeing or with coating or with rubberising;</p> <p>Yarn dyeing combined with weaving, knitting or nonwoven process;</p> <p>or</p> <p>Rubberising combined with at least two other main preparatory or finishing operations (such as calendering, shrink-resistance processes, heat setting, permanent finishing) provided that the value of non-originating materials used does not exceed 50 % of the EXW of the product.</p>
59.07	<p>Weaving, knitting or nonwoven fabric formation combined with dyeing or with printing or with coating or with impregnating or with covering;</p> <p>Flocking combined with dyeing or with printing;</p>



	<p>or</p> <p>Printing (as standalone operation).</p>
59.08	
- Incandescent gas mantles, impregnated:	Production from tubular knitted or crocheted gas-mantle fabric.
- Others:	CTH
59.09-59.11	<p>Spinning of natural or of man-made staple fibres combined with weaving;</p> <p>Extrusion of man-made fibres combined with weaving;</p> <p>Weaving combined with dyeing or with coating or with laminating;</p> <p>or</p> <p>Coating, flocking, laminating or metalizing combined with at least two other main preparatory or finishing operations (such as calendering, shrink-resistance processes, heat setting, permanent finishing) provided that the value of non-originating materials used does not exceed 50 % of the EXW of the product.</p>
<b>Chapter 60</b>	<b>Knitted or crocheted fabrics</b>
60.01-60.06	<p>Spinning of natural or man-made staple fibres combined with knitting or with crocheting;</p> <p>Extrusion of man-made filament yarn combined with knitting or with crocheting;</p> <p>Knitting or crocheting combined with dyeing or with flocking or with coating or with laminating or with printing;</p> <p>Flocking combined with dyeing or with printing;</p> <p>Yarn dyeing combined with knitting or with crocheting; or</p> <p>Twisting or texturing combined with knitting or with crocheting provided that the value of non-originating non-twisted or non-textured yarns used does not exceed 50 % of the EXW of the product.</p>
<b>Chapter 61</b>	<b>Articles of apparel and clothing accessories, knitted or crocheted</b>

61.01-61.17	
- Obtained by sewing together or otherwise assembling, two or more pieces of knitted or crocheted fabric which have been either cut to form or obtained directly to form:	Knitting or crocheting combined with making-up including cutting of fabric.
- Others:	Spinning of natural or man-made staple fibres combined with knitting or with crocheting;  Extrusion of man-made filament yarn combined with knitting or with crocheting; or  Knitting and making-up in one operation.
<b>Chapter 62</b>	<b>Articles of apparel and clothing accessories, not knitted or crocheted</b>
62.01	Weaving combined with making-up including cutting of fabric;  or  Making-up including cutting of fabric preceded by printing (as standalone operation).
62.02	
- Embroidered:	Weaving combined with making-up including cutting of fabric;  or  Production from unembroidered fabric, provided that the value of non-originating unembroidered fabric used does not exceed 40 % of the EXW of the product.
- Others:	Weaving combined with making-up including cutting of fabric;  or  Making-up including cutting of fabric preceded by printing (as standalone

	operation).
62.03	Weaving combined with making-up including cutting of fabric;  or  Making-up including cutting of fabric preceded by printing (as standalone operation).
62.04	
- Embroidered:	Weaving combined with making-up including cutting of fabric;  or  Production from unembroidered fabric, provided that the value of non-originating unembroidered fabric used does not exceed 40 % of the EXW of the product.
- Others:	Weaving combined with making-up including cutting of fabric;  or  Making-up including cutting of fabric preceded by printing (as standalone operation).
62.05	Weaving combined with making-up including cutting of fabric;  or  Making-up including cutting of fabric preceded by printing (as standalone operation).
62.06	
- Embroidered:	Weaving combined with making-up including cutting of fabric;  or  Production from unembroidered fabric, provided that the value of non-originating unembroidered fabric used does not exceed 40 % of the EXW of the product.
- Others:	Weaving combined with making-up including cutting of fabric;  or  Making-up including cutting of fabric preceded by printing (as standalone

	operation).
62.07-62.08	Weaving combined with making-up including cutting of fabric;  or  Making-up including cutting of fabric preceded by printing (as standalone operation).
62.09	
- Embroidered:	Weaving combined with making-up including cutting of fabric;  or  Production from unembroidered fabric, provided that the value of non-originating unembroidered fabric used does not exceed 40 % of the EXW of the product.
- Others:	Weaving combined with making-up including cutting of fabric;  or  Making-up including cutting of fabric preceded by printing (as standalone operation).
62.10	
- Fire-resistant equipment of fabric covered with foil of aluminised polyester:	Weaving combined with making-up including cutting of fabric;  or  Coating or laminating combined with making-up including cutting of fabric, provided that the value of non-originating uncoated or unlaminated fabric used does not exceed 40 % of the EXW of the product.
- Others:	Weaving combined with making-up including cutting of fabric;  or  Making-up including cutting of fabric preceded by printing (as standalone operation).
62.11	

- Women's, or girls' garments, embroidered:	Weaving combined with making-up including cutting of fabric; or Production from unembroidered fabric, provided that the value of non-originating unembroidered fabric used does not exceed 40 % of the EXW of the product.
- Others:	Weaving combined with making-up including cutting of fabric; or Making-up including cutting of fabric preceded by printing (as standalone operation).
62.12	
- Knitted or crocheted obtained by sewing together or otherwise assembling, two or more pieces of knitted or crocheted fabric which have been either cut to form or obtained directly to form:	Knitting combined with making-up including cutting of fabric; or Making-up including cutting of fabric preceded by printing (as standalone operation).
- Others:	Weaving combined with making-up including cutting of fabric; or Making-up including cutting of fabric preceded by printing (as standalone operation).
62.13-62.14	
- Embroidered:	Weaving combined with making-up including cutting of fabric; Production from unembroidered fabric, provided that the value of non-originating unembroidered fabric used does not exceed 40 % of the EXW of the

	<p>product;</p> <p>or</p> <p>Making-up including cutting of fabric preceded by printing (as standalone operation).</p>
- Others:	<p>Weaving combined with making-up including cutting of fabric;</p> <p>or</p> <p>Making-up including cutting of fabric preceded by printing (as standalone operation).</p>
62.15	<p>Weaving combined with making-up including cutting of fabric;</p> <p>or</p> <p>Making-up including cutting of fabric preceded by printing (as standalone operation).</p>
62.16	
- Fire-resistant equipment of fabric covered with foil of aluminised polyester:	<p>Weaving combined with making-up including cutting of fabric;</p> <p>or</p> <p>Coating or laminating combined with making-up including cutting of fabric, provided that the value of non-originating uncoated or unlaminated fabric used does not exceed 40 % of the EXW of the product.</p>
- Others:	<p>Weaving combined with making-up including cutting of fabric;</p> <p>or</p> <p>Making-up including cutting of fabric preceded by printing (as standalone operation).</p>
62.17	
- Embroidered:	<p>Weaving combined with making-up including cutting of fabric;</p> <p>Production from unembroidered fabric, provided that the value of non-originating unembroidered fabric used does not exceed 40 % of the EXW of the product;</p>

	<p>or</p> <p>Making-up including cutting of fabric preceded by printing (as standalone operation).</p>
- Fire-resistant equipment of fabric covered with foil of aluminised polyester:	<p>Weaving combined with making-up including cutting of fabric;</p> <p>or</p> <p>Coating or laminating combined with making-up including cutting of fabric, provided that the value of non-originating uncoated or unlaminated fabric used does not exceed 40 % of the EXW of the product.</p>
- Interlinings for collars and cuffs, cut out:	<p>CTH, provided that the value of all the non-originating materials used does not exceed 40 % of the EXW of the product.</p>
- Others:	<p>Weaving combined with making-up including cutting of fabric.</p>
<b>Chapter 63</b>	<b>Other made up textile articles; sets; worn clothing and worn textile articles; rags</b>
63.01-63.04	
- Of felt, of nonwovens:	<p>Nonwoven fabric formation combined with making-up including cutting of fabric.</p>
- Others:	
-- Embroidered:	<p>Weaving or knitting or crocheting combined with making-up including cutting of fabric;</p> <p>or</p> <p>Production from unembroidered fabric (other than knitted or crocheted), provided that the value of non-originating unembroidered fabric used does not exceed 40 % of the EXW of the product.</p>
-- Others:	<p>Weaving, knitting or crocheting combined with making-up including cutting of fabric.</p>

63.05	Extrusion of man-made fibres or spinning of natural or man-made staple fibres, combined with weaving or with knitting and making-up including cutting of fabric.
63.06	
- Of nonwovens:	Nonwoven fabric formation combined with making-up including cutting of fabric.
- Others:	Weaving combined with making-up including cutting of fabric.
63.07	MaxNOM 40 % (EXW).
63.08	Each item in the set must satisfy the rule which would apply to it if it were not included in the set; however, non-originating articles may be incorporated, provided that their total value does not exceed 15 % of the EXW of the set.
63.09-63.10	CTH
<b>SECTION XII</b>	<b>FOOTWEAR, HEADGEAR, UMBRELLAS, SUN UMBRELLAS, WALKING-STICKS, SEAT-STICKS, WHIPS, RIDING-CROPS AND PARTS THEREOF; PREPARED FEATHERS AND ARTICLES MADE THEREWITH; ARTIFICIAL FLOWERS; ARTICLE OF HUMAN HAIR</b>
<b>Chapter 64</b>	<b>Footwear, gaiters and the like; parts of such articles</b>
64.01-64.05	Production from non-originating materials of any heading, except from non-originating assemblies of uppers affixed to inner soles or to other sole components of heading 64.06.
64.06	CTH
<b>Chapter 65</b>	<b>Headgear and parts thereof</b>
65.01-65.07	CTH
<b>Chapter 66</b>	<b>Umbrellas, sun umbrellas, walking-sticks, seat-sticks, whips, riding-crops and parts thereof</b>



66.01-66.03	CTH;  or  MaxNOM 50 % (EXW).
<b>Chapter 67</b>	<b>Prepared feathers and down and articles made of feathers or of down; artificial flowers; articles of human hair</b>
67.01-67.04	CTH
<b>SECTION XIII</b>	<b>ARTICLES OF STONE, PLASTER, CEMENT, ASBESTOS, MICA OR SIMILAR MATERIALS; CERAMIC PRODUCTS; GLASS AND GLASSWARE</b>
<b>Chapter 68</b>	<b>Articles of stone, plaster, cement, asbestos, mica or similar materials</b>
68.01-68.15	CTH;  or  MaxNOM 70 % (EXW).
<b>Chapter 69</b>	<b>Ceramic products</b>
69.01-69.14	CTH
<b>Chapter 70</b>	<b>Glass and glassware</b>
70.01-70.09	CTH;  or  MaxNOM 50 % (EXW).
70.10	CTH
70.11	CTH;  or  MaxNOM 50 % (EXW).
70.13	CTH except from non-originating materials of heading 70.10.
70.14-70.20	CTH;  or  MaxNOM 50 % (EXW).
<b>SECTION XIV</b>	<b>NATURAL OR CULTURED PEARLS, PRECIOUS OR SEMI-PRECIOUS STONES, PRECIOUS METALS, METALS CLAD WITH PRECIOUS METAL, AND ARTICLES</b>

	<b>THEREOF; IMITATION JEWELLERY; COIN</b>
<b>Chapter 71</b>	<b>Natural or cultured pearls, precious or semi-precious stones, precious metals, metals clad with precious metal, and articles thereof; imitation jewellery; coin</b>
71.01-71.05	Production from non-originating materials of any heading.
71.06	
- Unwrought:	CTH except from non-originating materials of headings 71.06, 71.08 and 71.10;  Electrolytic, thermal or chemical separation of non-originating precious metals of headings 71.06, 71.08 and 71.10;  or  Fusion or alloying of non-originating precious metals of headings 71.06, 71.08 and 71.10 with each other or with base metals or purification.
- Semi-manufactured or in powder form:	Production from non-originating unwrought precious metals.
71.07	Production from non-originating materials of any heading.
71.08	
- Unwrought:	CTH except from non-originating materials of headings 71.06, 71.08 and 71.10;  Electrolytic, thermal or chemical separation of non-originating precious metals of headings 71.06, 71.08 and 71.10;  or  Fusion or alloying of non-originating precious metals of headings 71.06, 71.08 and 71.10 with each other or with base metals or purification.
- Semi-manufactured or in powder form:	Production from non-originating unwrought precious metals.
71.09	Production from non-originating materials of any heading.
71.10	
- Unwrought:	CTH except from non-originating materials of headings 71.06, 71.08 and 71.10;  Electrolytic, thermal or chemical separation of non-originating precious metals of headings 71.06, 71.08 and 71.10;  or

	Fusion or alloying of non-originating precious metals of headings 71.06, 71.08 and 71.10 with each other or with base metals or purification.
- Semi-manufactured or in powder form:	Production from non-originating unwrought precious metals.
71.11	Production from non-originating materials of any heading.
71.12-71.18	CTH
SECTION XV	BASE METALS AND ARTICLES OF BASE METAL
Chapter 72	Iron and Steel
72.01-72.06	CTH
72.07	CTH except from non-originating materials of heading 72.06.
72.08-72.17	CTH except from non-originating materials of headings 72.08 to 72.17.
72.18	CTH
72.19-72.23	CTH except from non-originating materials of headings 72.19 to 72.23.
72.24	CTH
72.25-72.29	CTH except from non-originating materials of headings 72.25 to 72.29.
<b>Chapter 73</b>	<b>Articles of iron or steel</b>
7301.10	CC except from non-originating materials of headings 72.08 to 72.17.
7301.20	CTH
73.02	CC except from non-originating materials of headings 72.08 to 72.17.
73.03	CTH

73.04-73.06	CC except from non-originating materials of headings 72.13 to 72.17, 72.21 to 72.23 and 72.25 to 72.29.
73.07	
- Tube or pipe fittings of stainless steel:	CTH except from non-originating forged blanks; however, non-originating forged blanks may be used provided that their value does not exceed 50 % of the EXW of the product.
- Others:	CTH
73.08	CTH except from non-originating materials of subheading 7301.20.
7309.00-7315.19	CTH
7315.20	CTH; or MaxNOM 50 % (EXW).
7315.81-7326.90	CTH
<b>Chapter 74</b>	<b>Copper and articles thereof</b>
74.01-74.02	CTH
74.03	Production from non-originating materials of any heading.
74.04-74.07	CTH
74.08	CTH and MaxNOM 50 % (EXW).
74.09-74.19	CTH
<b>Chapter 75</b>	<b>Nickel and articles thereof</b>
75.01	CTH
75.02	Production from non-originating materials of any heading.
75.03-75.08	CTH
<b>Chapter 76</b>	<b>Aluminium and articles thereof</b>
76.01	CTH and MaxNOM 50 % (EXW). or Thermal or electrolytic treatment from unalloyed aluminium or waste and scrap of aluminium.

76.02	CTH
76.03-76.16	CTH and MaxNOM 50 % (EXW). <sup>90</sup>
<b>Chapter 78</b>	<b>Lead and articles thereof</b>
7801.10	Production from non-originating materials of any heading.
7801.91-7806.00	CTH
<b>Chapter 79</b>	<b>Zinc and articles thereof</b>
79.01-79.07	CTH
<b>Chapter 80</b>	<b>Tin and articles thereof</b>
80.01-80.07	CTH
<b>Chapter 81</b>	<b>Other base metals; cermets; articles thereof</b>
81.01-81.13	Production from non-originating materials of any heading.
<b>Chapter 82</b>	<b>Tools, implements, cutlery, spoons and forks, of base metal; parts thereof of base metal</b>
8201.10-8205.70	CTH;  or  MaxNOM 50 % (EXW).
8205.90	CTH, however, non-originating tools of heading 82.05 may be incorporated into the set, provided that their total value does not exceed 15 % of the EXW of the set.
82.06	CTH except from non-originating materials of headings 82.02 to 82.05; however, non-originating tools of headings 82.02 to 82.05 may be incorporated into the set, provided that their total value does not exceed 15 % of the EXW of the set.
82.07-82.15	CTH;  Or  MaxNOM 50 % (EXW).
<b>Chapter 83</b>	<b>Miscellaneous articles of base metal</b>

---

<sup>90</sup> Certain aluminium products may qualify as originating under alternative product-specific rules of origin with annual quotas as specified in Annex ORIG-2A [Origin quotas and alternatives to the product-specific rules of origin in Annex ORIG-2].

83.01-83.11	CTH;  or  MaxNOM 50 % (EXW).
<b>SECTION XVI</b>	<b>MACHINERY AND MECHANICAL APPLIANCE; ELECTRICAL EQUIPMENT; PARTS THEREOF; SOUND RECORDERS AND REPRODUCERS, TELEVISION IMAGE AND SOUND RECORDERS AND REPRODUCERS, AND PARTS AND ACCESSORIES OF SUCH ARTICLES</b>
<b>Chapter 84</b>	<b>Nuclear reactors, boilers, machinery and mechanical appliances; parts thereof</b>
84.01-84.06	CTH;  or  MaxNOM 50 % (EXW).
84.07-84.08	MaxNOM 50 % (EXW).
84.09-84.12	CTH;  or  MaxNOM 50 % (EXW).
8413.11-8415.10	CTSH;  or  MaxNOM 50 % (EXW).
8415.20	CTH;  or  MaxNOM 50 % (EXW).
8415.81-8415.90	CTSH;  or  MaxNOM 50 % (EXW).
84.16-84.20	CTH;  or  MaxNOM 50 % (EXW).
84.21	CTSH;

	or MaxNOM 50 % (EXW).
84.22-84.24	CTH;  or MaxNOM 50 % (EXW).
84.25-84.30	CTH except from non-originating materials of heading 84.31;  or MaxNOM 50 % (EXW).
84.31-84.43	CTH;  or MaxNOM 50 % (EXW).
84.44-84.47	CTH except from non-originating materials of heading 84.48;  or MaxNOM 50 % (EXW).
84.48-84.55	CTH;  or MaxNOM 50 % (EXW).
84.56-84.65	CTH except from non-originating materials of heading 84.66;  or MaxNOM 50 % (EXW).
84.66-84.68	CTH;  or MaxNOM 50 % (EXW).
84.70-84.72	CTH except from non-originating materials of heading 84.73;  or MaxNOM 50 % (EXW).

84.73-84.78	CTH; or MaxNOM 50 % (EXW).
8479.10-8479.40	CTSH; or MaxNOM 50 % (EXW).
8479.50	CTH; or MaxNOM 50 % (EXW).
8479.60-8479.82	CTSH; or MaxNOM 50 % (EXW).
8479.89	CTH; or MaxNOM 50 % (EXW).
8479.90	CTSH; or MaxNOM 50 % (EXW).
84.80	CTH; or MaxNOM 50 % (EXW).
84.81	CTSH; or MaxNOM 50 % (EXW).
84.82-84.87	CTH; or



	MaxNOM 50 % (EXW).
<b>Chapter 85</b>	<b>Electrical machinery and equipment and parts thereof; sound recorders and reproducers, television image and sound recorders and reproducers, and parts and accessories of such articles</b>
85.01-85.02	CTH except from non-originating materials of heading 85.03; or MaxNOM 50 % (EXW).
85.03-85.06	CTH; or MaxNOM 50 % (EXW).
85.07	
- Accumulators containing one or more battery cells or battery modules and the circuitry to interconnect them amongst themselves,  often referred to as “battery packs”, of a kind used as the primary source of electrical power for propulsion of vehicles of headings 87.02, 87.03 and 87.04	CTH except from non-originating active cathode materials; or MaxNOM 30 % (EXW) <sup>91</sup> .
- Battery cells, battery modules and parts thereof, intended to be incorporated into	CTH except from non-originating active cathode materials; or MaxNOM 35 % (EXW) <sup>92</sup>

---

<sup>91</sup> For the period from the entry into force of this Agreement until 31 December 2026 alternative product-specific rules of origin apply, as specified in Annex ORIG-2B [Transitional Product-Specific Rules for Electric Accumulators and Electrified Vehicles].

an electric accumulator of a kind used as the primary source of electrical power for propulsion of vehicles of headings 87.02, 87.03 and 87.04	
- others	CTH;  or  MaxNOM 50 % (EXW).
85.08-85.18	CTH;  or  MaxNOM 50 % (EXW).
85.19-85.21	CTH except from non-originating materials of heading 85.22;  or  MaxNOM 50 % (EXW).
85.22-85.23	CTH;  or  MaxNOM 50 % (EXW).
85.25-85.27	CTH except from non-originating materials of heading 85.29;  or  MaxNOM 50 % (EXW).
85.28-85.34	CTH;  or  MaxNOM 50 % (EXW).

---

<sup>92</sup> For the period from the entry into force of this Agreement until 31 December 2026 alternative product-specific rules of origin apply, as specified in Annex ORIG-2B [Transitional Product-Specific Rules for Electric Accumulators and Electrified Vehicles].

85.35-85.37	CTH except from non-originating materials of heading 85.38; or MaxNOM 50 % (EXW).
8538.10-8541.90	CTH; or MaxNOM 50 % (EXW).
8542.31-8542.39	CTH; Non-originating materials undergo a diffusion; or MaxNOM 50 % (EXW).
8542.90-8543.90	CTH; or MaxNOM 50 % (EXW).
85.44-85.48	MaxNOM 50 % (EXW).
<b>SECTION XVII</b>	<b>VEHICLES, AIRCRAFT, VESSELS AND ASSOCIATED TRANSPORT EQUIPMENT</b>
<b>Chapter 86</b>	<b>Railway or tramway locomotives, rolling-stock and parts thereof; railway or tramway track fixtures and fittings and parts thereof; mechanical (including electro-mechanical) traffic signalling equipment of all kinds</b>
86.01-86.09	CTH except from non-originating materials of heading 86.07; or MaxNOM 50 % (EXW).
<b>Chapter 87</b>	<b>Vehicles other than railway or tramway rolling-stock, and parts and accessories thereof</b>
87.01	MaxNOM 45 % (EXW).
87.02-87.04	

- vehicles with both internal combustion piston engine and electric motor as motors for propulsion capable of being charged by plugging to external source of electric power ('plug-in hybrid');  - vehicles with only electric motor for propulsion	MaxNOM 45 % (EXW) and battery packs of heading 85.07 of a kind used as the primary source of electrical power for propulsion of the vehicle must be originating <sup>93</sup> .
- others	MaxNOM 45 % (EXW) <sup>94</sup> .
87.05-87.07	MaxNOM 45 % (EXW).
87.08-87.11	CTH;  or  MaxNOM 50 % (EXW).
87.12	MaxNOM 45 % (EXW).
87.13-87.16	CTH;  or  MaxNOM 50 % (EXW).
<b>Chapter 88</b>	<b>Aircraft, spacecraft, and parts thereof</b>
88.01-88.05	CTH;  or

---

<sup>93</sup> For the period from the entry into force of this Agreement until 31 December 2026 alternative product-specific rules of origin apply, as specified in Annex ORIG-2B [Transitional Product-Specific Rules for Electric Accumulators and Electrified Vehicles].

<sup>94</sup> For hybrid vehicles with both internal combustion engine and electric motor as motors for propulsion, other than those capable of being charged by plugging to external source of electric power, alternative product-specific rules of origin apply for the period from the entry into force of this Agreement until 31 December 2026, as specified in Annex ORIG-2B [Transitional Product-Specific Rules for Electric Accumulators and Electrified Vehicles].

	MaxNOM 50 % (EXW).
<b>Chapter 89</b>	<b>Ships, boats and floating structures</b>
89.01-89.08	CC;  or  MaxNOM 40 % (EXW).
<b>SECTION XVIII</b>	<b>OPTICAL, PHOTOGRAPHIC, CINEMATOGRAPHIC, MEASURING, CHECKING, PRECISION, MEDICAL OR SURGICAL INSTRUMENTS AND APPARATUS; CLOCKS AND WATCHES; MUSICAL INSTRUMENTS; PARTS AND ACCESSORIES THEREOF</b>
<b>Chapter 90</b>	<b>Optical, photographic, cinematographic, measuring, checking, precision, medical or surgical instruments and apparatus; parts and accessories thereof</b>
9001.10-9001.40	CTH;  or  MaxNOM 50 % (EXW).
9001.50	CTH;  Surfacing of the semi-finished lens into a finished ophthalmic lens with optical corrective power meant to be mounted on a pair of spectacles;  Coating of the lens through appropriated treatments to improve vision and ensure protection of the wearer;  or  MaxNOM 50 % (EXW).
9001.90-9033.00	CTH;  or  MaxNOM 50 % (EXW).
<b>Chapter 91</b>	<b>Clocks and watches and parts thereof</b>
91.01-91.14	CTH;  or  MaxNOM 50 % (EXW).
<b>Chapter 92</b>	<b>Musical instruments; parts and accessories of such articles</b>
92.01-92.09	MaxNOM 50 % (EXW).

<b>SECTION XIX</b>	<b>ARMS AND AMMUNITION; PARTS AND ACCESSORIES THEREOF</b>
<b>Chapter 93</b>	<b>Arms and ammunition; parts and accessories thereof</b>
93.01-93.07	MaxNOM 50 % (EXW).
<b>SECTION XX</b>	<b>MISCELLANEOUS MANUFACTURED ARTICLES</b>
<b>Chapter 94</b>	<b>Furniture; bedding, mattresses, mattress supports, cushions and similar stuffed furnishings; lamps and lighting fittings, not elsewhere specified or included; illuminated signs, illuminated name-plates and the like; prefabricated buildings</b>
94.01-94.06	CTH;  or  MaxNOM 50 % (EXW).
<b>Chapter 95</b>	<b>Toys, games and sports requisites; parts and accessories thereof</b>
95.03-95.08	CTH;  or  MaxNOM 50 % (EXW).
<b>Chapter 96</b>	<b>Miscellaneous manufactured articles</b>
96.01-96.04	CTH;  or  MaxNOM 50 % (EXW).
96.05	Each item in the set shall satisfy the rule which would apply to it if it were not included in the set, provided that non-originating articles may be incorporated, provided that their total value does not exceed 15 % of the EXW of the set.
96.06-9608.40	CTH;  or  MaxNOM 50 % (EXW).
9608.50	Each item in the set shall satisfy the rule which would apply to it if it were not included in the set, provided that non-originating articles may be incorporated, provided that their total value does not exceed 15 % of the EXW of the set.
9608.60-96.20	CTH;  or

	MaxNOM 50 % (EXW).
<b>SECTION XXI</b>	<b>WORKS OF ART, COLLECTORS' PIECES AND ANTIQUES</b>
<b>Chapter 97</b>	<b>Works of Art, Collectors' Pieces and Antiques</b>
97.01-97.06	CTH

**ANNEX ORIG-2A: ORIGIN QUOTAS AND ALTERNATIVES TO THE PRODUCT-SPECIFIC RULES OF ORIGIN  
IN ANNEX ORIG-2 [PRODUCT-SPECIFIC RULES OF ORIGIN]**

Common provisions

1. For the products listed in the tables below, the corresponding rules of origin are alternatives to those set out in Annex ORIG-2 [Product-specific rules of origin], within the limits of the applicable annual quota.
2. A statement on origin made out pursuant to this Annex shall contain the following statement: "Origin quotas - Product originating in accordance with Annex ORIG-2A".
3. In the Union, any quantities referred to in this Annex shall be managed by the European Commission, which shall take all administrative actions it deems advisable for their efficient management in respect of the applicable legislation of the Union.
4. In the United Kingdom, any quantities referred to in this Annex shall be managed by its customs authority, which shall take all administrative actions it deems advisable for their efficient management in respect of the applicable legislation in the United Kingdom.
5. The importing Party shall manage the origin quotas on a first-come first-served basis and shall calculate the quantity of products entered under these origin quotas on the basis of that Party's imports.

**Section 1 - Annual quota allocation for canned tuna**

<b>Harmonised system classification (2017)</b>	<b>Product description</b>	<b>Alternative product-specific rule</b>	<b>Annual quota for exports from the Union to the United Kingdom  (net weight)</b>	<b>Annual quota for exports from the United Kingdom to the Union  (net weight)</b>
<b>1604.14</b>	Prepared or preserved tunas, skipjack and bonito ( <i>Sarda spp.</i> ), whole or in pieces (excl. minced)	CC	3 000 tonnes	3 000 tonnes
<b>1604.20</b>	Other prepared or preserved fish			
	Of tuna, skipjack or other fish of the genus <i>Euthynnus</i> (excl. whole or in pieces)	CC	4 000 tonnes	4 000 tonnes
	Of other fish	-	-	-



Section 2 – Annual quota allocation for aluminium products<sup>95</sup>

Table 1 – Quotas applicable from 1 January 2021 until 31 December 2023

Harmonised system classification (2017)	Product description	Alternative product-specific rule	Annual quota for exports from the Union to the United Kingdom (net weight)	Annual quota for exports from the United Kingdom to the Union (net weight)
<b>76.03, 76.04, 76.06, 76.08-76.16</b>	Aluminium products and articles of aluminium (excluding aluminium wire and aluminium foil)	CTH	95 000 tonnes	95 000 tonnes
<b>76.05</b>	Aluminium wire	CTH except from non-originating materials of heading 76.04		
<b>76.07</b>	Aluminium foil	CTH except from non-originating materials of heading 76.06		

Table 2 – Quotas applicable from 1 January 2024 until 31 December 2026

Harmonised system classification (2017)	Product description	Alternative product-specific rule	Annual quota for exports from the Union to the United Kingdom (net weight)	Annual quota for exports from the United Kingdom to the Union (net weight)
<b>76.03, 76.04, 76.06, 76.08-76.16</b>	Aluminium products and articles of aluminium (excluding aluminium wire and aluminium foil)	CTH	72 000 tonnes	72 000 tonnes
<b>76.05</b>	Aluminium wire	CTH except from non-originating materials of heading 76.04		
<b>76.07</b>	Aluminium foil	CTH except from non-originating materials of heading 76.06		

<sup>95</sup> The quantities listed in each table in Section 2 are the entire quota quantities available (for exports from the Union to the United Kingdom, and for exports from the United Kingdom to the Union, respectively) for all the products listed in that table.

**Table 3 - Quotas applicable from 1 January 2027 onwards**

<b>Harmonised system classification (2017)</b>	<b>Product description</b>	<b>Alternative product-specific rule</b>	<b>Annual quota for exports from the Union to the United Kingdom (net weight)</b>	<b>Annual quota for exports from the United Kingdom to the Union (net weight)</b>
<b>76.04</b>	Aluminium bars, rods and profiles	CTH	57 500 tonnes	57 500 tonnes
<b>76.06</b>	Aluminium plates, sheets and strip, of a thickness exceeding 0,2 mm	CTH		
<b>76.07</b>	Aluminium foil	CTH except from non-originating materials of heading 76.06		

**Review of quotas for aluminium products in Table 3 in Section 2**

1. Not earlier than 5 years from the entry into force of this Agreement and not earlier than 5 years from the completion of any review referred to in this paragraph, the Trade Partnership Committee, at the request of either Party and assisted by the Trade Specialised Committee on Customs Cooperation and Rules of Origin, shall review the quotas for aluminium contained in Table 3 in Section 2.
2. The review referred to in paragraph 1 shall be made on the basis of available information about the market conditions in both Parties and information about their imports and exports of relevant products.
3. On the basis of the result of a review carried out pursuant to paragraph 1, the Partnership Council may adopt a decision to increase or maintain the quantity, to change the scope, or to apportion or change any apportionment between products, of the quotas for aluminium contained in Table 3 in Section 2.

ANNEX ORIG-2B: TRANSITIONAL PRODUCT-SPECIFIC RULES FOR ELECTRIC ACCUMULATORS AND ELECTRIFIED VEHICLES

**Section 1 - Interim product specific rules applicable from the entry into force of this Agreement until 31 December 2023.**

1. For the products listed in column 1 below, the product-specific rule listed in column 2 shall apply for the period from the entry into force of this Agreement until 31 December 2023.

<b>Column 1</b>  <b>Harmonised classification including description</b>	<b>Column 2</b>  <b>Product-specific rule of origin applicable from the entry into force of this Agreement until 31 December 2023</b>
85.07	
- Accumulators containing one or more battery cells or battery modules and the circuitry to interconnect them amongst themselves, often referred to as “battery packs”, of a kind used as the primary source of electrical power for propulsion of vehicles of headings 87.02, 87.03 and 87.04	CTSH;  Assembly of battery packs from non-originating battery cells or battery modules;  or  MaxNOM 70 % (EXW)
- Battery cells, battery modules, and parts thereof, intended to be incorporated into an electric accumulator of a kind used as the primary source of electrical power for propulsion of vehicles of headings 87.02, 87.03 and 87.04	CTH;  or  MaxNOM 70 % (EXW)
87.02-87.04	
- vehicles with both internal combustion engine and electric motor as motors for propulsion other than those capable	MaxNOM 60 % (EXW)

<p>of being charged by plugging to external source of electric power ('hybrid');</p> <p>- vehicles with both internal combustion piston engine and electric motor as motors for propulsion capable of being charged by plugging to external source of electric power ('plug-in hybrid');</p> <p>- vehicles with only electric motor for propulsion</p>	
--	--

**Section 2 - Interim product specific rules applicable from 1 January 2024 until 31 December 2026.**

1. For the products listed in column 1 below, the product specific rule listed in column 2 shall apply for the period from 1 January 2024 until 31 December 2026.

<b>Column 1</b>	<b>Column 2</b>
<b>Harmonised classification including description</b>	<b>System (2017) specific</b>
	<b>Product-specific rule of origin applicable from 1 January 2024 until 31 December 2026</b>
85.07	
- Accumulators containing one or more battery cells or battery modules and the circuitry to interconnect them amongst themselves, often referred to as "battery packs", of a kind used as the primary source of electrical power for propulsion of vehicles of headings 87.02, 87.03 and 87.04	CTH except from non-originating active cathode materials;  or  MaxNOM 40 % (EXW)

<p>- Battery cells, battery modules, and parts thereof, intended to be incorporated into an electric accumulator of a kind used as the primary source of electrical power for propulsion of vehicles of headings 87.02, 87.03 and 87.04</p>	<p>CTH except from non-originating active cathode materials; or MaxNOM 50 % (EXW)</p>
<p>87.02-87.04</p>	
<p>- vehicles with both internal combustion engine and electric motor as motors for propulsion other than those capable of being charged by plugging to external source of electric power ('hybrid');</p> <p>- vehicles with both internal combustion piston engine and electric motor as motors for propulsion capable of being charged by plugging to external source of electric power ('plug-in hybrid');</p> <p>- vehicles with only electric motor for propulsion</p>	<p>MaxNOM 55 % (EXW)</p>

### Section 3 – Review of Product-Specific rules for Heading 8507

1. Not earlier than 4 years from the entry into force of this Agreement, the Trade Partnership Committee shall, on request of either Party and assisted by the Trade Specialised Committee on Customs Cooperation and Rules of Origin, review the product-specific rules for heading 8507 applicable as from 1 January 2027, contained in Annex ORIG-2 [[Product-Specific Rules of Origin](#)].

2. The review referred to in paragraph 1, shall be made on the basis of available information about the markets within the Parties, such as the availability of sufficient and suitable originating materials, the balance between supply and demand and other relevant information.

3. On the basis of the results of the review carried out pursuant to paragraph 1, the Partnership Council may adopt a decision to amend the product-specific rules for heading 8507 applicable as from 1 January 2027, contained in Annex ORIG-2 [Product-Specific Rules of Origin].

### *ANNEX ORIG-3: SUPPLIER'S DECLARATION*

1. A supplier's declaration shall have the content set out in this Annex.
2. Except in the cases referred to in point 3, a supplier's declaration shall be made out by the supplier for each consignment of products in the form provided for in Appendix 1 and annexed to the invoice, or to any other document describing the products concerned in sufficient detail to enable them to be identified.
3. Where a supplier regularly supplies a particular customer with products for which the production carried out in a Party is expected to remain constant for a period of time, that supplier may provide a single supplier's declaration to cover subsequent consignments of those products (the 'long-term supplier's declaration'). A long-term supplier's declaration is normally valid for a period of up to two years from the date of making out the declaration. The customs authorities of the Party where the declaration is made out may lay down the conditions under which longer periods may be used. The long-term supplier's declaration shall be made out by the supplier in the form provided for in Appendix 2 and shall describe the products concerned in sufficient detail to enable them to be identified. The supplier shall inform the customer immediately if the long-term supplier's declaration ceases to apply to the products supplied.
4. The supplier making out a declaration shall be prepared to submit at any time, at the request of the customs authorities of the Party where the declaration is made out, all appropriate documents proving that the information given on that declaration is correct.

**Appendix 1**

**SUPPLIER'S DECLARATION**

The supplier's declaration, the text of which is provided below, must be made out in accordance with the footnotes. However, the footnotes do not have to be reproduced.

**SUPPLIER'S DECLARATION**

I, the undersigned, the supplier of the products covered by the annexed document, declare that:

1. The following materials which do not originate in [indicate the name of the relevant Party] have been used in [indicate the name of the relevant Party] to produce these products:

Description of the products supplied <sup>(1)</sup>	Description of non-originating materials used	HS heading of non-originating materials used <sup>(2)</sup>	Value of non-originating materials used <sup>(2)(3)</sup>
Total value			

2. All the other materials used in [indicate the name of the relevant Party] to produce those products originate in [indicate the name of the relevant Party]

I undertake to make available any further supporting documents required.  
..... (Place and Date)  
.....(Name and position of the undersigned, name and  
address of company)  
..... (Signature)(6)  
\_\_\_\_\_



**Appendix 2**

**LONG-TERM SUPPLIER'S DECLARATION**

The long-term supplier's declaration, the text of which is given below, must be made out in accordance with the footnotes. However, the footnotes do not have to be reproduced.

LONG-TERM SUPPLIER'S DECLARATION

I, the undersigned, the supplier of the products covered by the annexed document, which are regularly supplied to<sup>(4)</sup> ....., declare that:

1. The following materials which do not originate in [indicate the name of the relevant Party] have been used in [indicate the name of the relevant Party] to produce these products:

Description of the products supplied <sup>(1)</sup>	Description of non-originating materials used	HS heading of non-originating materials used <sup>(2)</sup>	Value of non-originating materials used <sup>(2)(3)</sup>
Total value			

2. All the other materials used in [indicate the name of the relevant Party] to produce those products originate in a Party [indicate the name of the relevant Party];

This declaration is valid for all subsequent consignments of these products dispatched

from ..... to  
 ..... ( 5 )

I undertake to inform ..... ( 4 )  
 immediately if this declaration ceases to be valid.

..... (Place and Date)  
 .....(Name and position of the undersigned, name and  
 address of company)  
 ..... (Signature)  
 (6)

**Footnotes**

(1) Where the invoice or other document to which the declaration is annexed relates to different kinds of products, or to products which do not incorporate non-originating materials to the same extent, the supplier must clearly differentiate them.

(2) The information requested does not have to be given unless it is necessary.

Examples:

One of the rules for garments of Chapter 62 provides “Weaving combined with making-up including cutting of fabric”. If a manufacturer of such garments in a Party uses fabric imported from the other Party which has been obtained there by weaving non-originating yarn, it is sufficient for the supplier in the latter Party to describe in his declaration the non-originating material used as yarn, without it being necessary to indicate the HS heading and the value of such yarn.

A producer of wire of iron of HS heading 7217 who has produced it from non-originating iron bars should indicate in the second column 'bars of iron'. Where that wire is to be used in the production of a machine for which the rule contains a limitation for all non-originating materials used to a certain percentage value, it is necessary to indicate in the third column the value of non-originating bars.

(3) ‘Value of non-originating materials used’ means the value of the non-originating materials used in the production of the product, which is its customs value at the time of importation, including freight, insurance if appropriate, packing and all other costs incurred in transporting the materials to the importation port in the Party where the producer of the product is located; where the value of the non-originating materials is not known and cannot be ascertained, the first ascertainable price paid for the non-originating materials in the Union or in the United Kingdom is used.

(4) Name and address of the customer

(5) Insert dates

(6) This field may contain an electronic signature, a scanned image or other visual representation of the signer’s handwritten signature instead of original signatures, where appropriate.

ANNEX ORIG-4: TEXT OF THE STATEMENT ON ORIGIN

The statement on origin referred to in Article ORIG.19 [Statement on origin] of this Agreement shall be made out using the text set out below in one of the following language versions and in accordance with the laws and regulations of the exporting Party. If the statement on origin is handwritten, it shall be written in ink in printed characters. The statement on origin shall be made out in accordance with the respective footnotes. The footnotes do not have to be reproduced.

- Bulgarian version
- Croatian version
- Czech version
- Danish version
- Dutch version
- English version
- Estonian version
- Finnish version
- French version
- German version
- Greek version
- Hungarian version
- Italian version
- Latvian version
- Lithuanian version
- Maltese version
- Polish version
- Portuguese version
- Romanian version
- Slovak version
- Slovenian version
- Spanish version
- Swedish version

(Period: from \_\_\_\_\_ to \_\_\_\_\_ <sup>(1)</sup>)

The exporter of the products covered by this document (Exporter Reference No ... <sup>(2)</sup>) declares that, except where otherwise clearly indicated, these products are of ... <sup>(3)</sup> preferential origin.

..... <sup>(4)</sup>

(Place and date)

.....

(Name of the exporter)

---

<sup>1</sup> If the statement on origin is completed for multiple shipments of identical originating products within the meaning of point (b) of Article ORIG.19(4) [Statement on Origin] of this Agreement, indicate the period for which the statement on origin is to apply. That period shall not exceed 12

months. All importations of the product must occur within the period indicated. If a period is not applicable, the field may be left blank.

<sup>2</sup> Indicate the reference number by which the exporter is identified. For the Union exporter, this will be the number assigned in accordance with the laws and regulations of the Union. For the United Kingdom exporter, this will be the number assigned in accordance with the laws and regulations applicable within the United Kingdom. Where the exporter has not been assigned a number, this field may be left blank.

<sup>3</sup> Indicate the origin of the product: the United Kingdom or the Union.

<sup>4</sup> Place and date may be omitted if the information is contained on the document itself.

*ANNEX ORIG-5: JOINT DECLARATION CONCERNING THE PRINCIPALITY OF ANDORRA*

1. Products originating in the Principality of Andorra that fall within Chapters 25 to 97 of the Harmonised System shall be accepted by the United Kingdom as originating in the Union within the meaning of this Agreement.
2. Paragraph 1 only applies if, by virtue of the customs union established by Council Decision 90/680/EEC of 26 November 1990 on the conclusion of an agreement in the form of an exchange of letters between the European Economic Community and the Principality of Andorra, the Principality of Andorra applies to products originating in the United Kingdom the same preferential tariff treatment as the Union applies to such products.
3. Part Two, Heading One [Trade], Title I, Chapter two of this Agreement applies mutatis mutandis for the purpose of defining the originating status of products referred to in paragraph 1 of this Joint Declaration.

*ANNEX ORIG-6: JOINT DECLARATION CONCERNING THE REPUBLIC OF SAN MARINO*

1. Products originating in the Republic of San Marino shall be accepted by the United Kingdom as originating in the Union within the meaning of this Agreement.
2. Paragraph 1 only applies if, by virtue of the Agreement on Cooperation and Customs Union between the European Economic Community and the Republic of San Marino, done at Brussels on 16 December 1991, the Republic of San Marino applies to products originating in the United Kingdom the same preferential tariff treatment as the Union applies to such products.
3. Part Two, Heading One [Trade], Title I, Chapter two of this Agreement applies mutatis mutandis for the purposes of defining the originating status of products referred to in paragraph 1 of this Joint Declaration.

*ANNEX SPS-1: CRITERIA REFERRED TO IN ARTICLE SPS.19(d)*

The criteria referred to in Article SPS.19(d) are:

- a) the information made available by the exporting Party for the purposes of obtaining import authorisation for a given product into the importing party according to Article SPS.7(3) [Import conditions and procedures] of this Agreement;
- b) the outcome of audits and verifications by the importing party in accordance with Article SPS.11 [Audits and verifications] of this Agreement;
- c) the frequency and severity of non-compliance detected by the importing party on products from the exporting party;
- d) the exporting operators' past record as regards compliance with the requirements of the importing party; and
- e) available scientific assessments and any other pertinent information regarding the risk associated with the products.

## ANNEX TBT-1: MOTOR VEHICLES AND EQUIPMENT AND PARTS THEREOF

### Article 1: Definitions

1. For the purposes of this Annex:
  - (a) “WP.29” means the World Forum for Harmonisation of Vehicle Regulations within the framework of the United Nations Economic Commission for Europe (“UNECE”);
  - (b) “1958 Agreement” means the Agreement Concerning the Adoption of Harmonized Technical United Nations Regulations for Wheeled Vehicles, Equipment and Parts which can be Fitted and/or be Used on Wheeled Vehicles and the Conditions for Reciprocal Recognition of Approvals Granted on the Basis of these United Nations Regulations, done at Geneva on 20 March 1958, administered by the WP.29, and all subsequent amendments and revisions thereof;
  - (c) “1998 Agreement” means the Agreement concerning the Establishing of Global Technical Regulations for Wheeled Vehicles, Equipment and Parts which can be Fitted and/or be Used on Wheeled Vehicles, done at Geneva on 25 June 1998, administered by the WP.29, and all subsequent amendments and revisions thereof;
  - (d) “UN Regulations” means Regulations adopted in accordance with the 1958 Agreement;
  - (e) “GTR” means a Global Technical Regulation established and placed on the Global Registry in accordance with the 1998 Agreement;
  - (f) “HS 2017” means the 2017 edition of the Harmonised System Nomenclature issued by the World Customs Organization;
  - (g) “type approval” means the procedure whereby an approval authority certifies that a type of vehicle, system, component or separate technical unit satisfies the relevant administrative provisions and technical requirements;
  - (h) “type-approval certificate” means the document whereby an approval authority officially certifies that a type of vehicle, system, component or separate technical unit is type-approved.
2. Terms referred to in this Annex shall have the same meaning as they have in the 1958 Agreement or in Annex 1 to the TBT Agreement.

### Article 2: Product scope

This Annex applies to the trade between the Parties of all categories of motor vehicles, equipment and parts thereof, as defined in Paragraph 1.1. of UNECE Consolidated Resolution on the Construction of Vehicles (R.E.3)<sup>96</sup>, falling under, inter alia, Chapters 40, 84, 85, 87 and 94 of the HS 2017 (hereinafter referred to as “products covered”).

---

<sup>96</sup> ECE/TRANS/WP.29/78/Rev.6 of 11 July 2017.



### Article 3: Objectives

With regard to the products covered, the objectives of this Annex are to:

- (a) eliminate and prevent any unnecessary technical barriers to bilateral trade;
- (b) promote the compatibility and convergence of regulations based on international standards;
- (c) promote the recognition of approvals based on approval schemes applied under the agreements administered by WP.29;
- (d) reinforce competitive market conditions based on principles of openness, non-discrimination and transparency;
- (e) promote high levels of protection of human health, safety and the environment; and
- (f) maintain cooperation on issues of mutual interest to foster continued mutually beneficial development in trade.

### Article 4: Relevant international standards

The Parties recognise that the WP.29 is the relevant international standardising body and that UN Regulations and GTRs under the 1958 Agreement and 1998 Agreement are relevant international standards for the products covered by this Annex.

### Article 5: Regulatory convergence based on relevant international standards

1. The Parties shall refrain from introducing or maintaining any domestic technical regulation, marking, or conformity assessment procedure diverging from UN Regulations or GTRs in areas covered by such Regulations or GTRs, including where the relevant UN Regulations or GTRs have not been completed but their completion is imminent, unless there are substantiated reasons why a specific UN Regulation or GTR is an ineffective or inappropriate means for the fulfilment of legitimate objectives pursued, for example, in the areas of road safety or the protection of the environment or human health.

2. A Party which introduces a divergent domestic technical regulation, marking, or conformity assessment procedure as referred to in paragraph 1, at the request of the other Party, shall identify the parts of the domestic technical regulation, marking, or conformity assessment procedure which substantially diverge from the relevant UN Regulations or GTRs and provide justification for the divergence.

3. Each Party shall systematically consider applying UN Regulations adopted after the entry into force of this Agreement, and shall inform each other of any changes regarding the implementation of those UN Regulations in its respective domestic legal system following the protocol established under the 1958 Agreement and in line with Articles 8 and 9.

4. Insofar as a Party has introduced or maintains domestic technical regulations, markings or conformity assessment procedures that diverge from UN Regulations or GTRs as permitted by paragraph 1, that Party shall review those domestic technical regulations, markings or conformity assessment procedures at regular intervals, preferably not exceeding five years, with a view to

increasing their convergence with the relevant UN Regulations or GTRs. When reviewing their domestic technical regulations, markings and conformity assessment procedures, each Party shall consider whether the justification for the divergence still exists. The outcome of these reviews, including any scientific and technical information used, shall be notified to the other Party upon request.

5. Each Party shall refrain from introducing or maintaining domestic technical regulations, markings, or conformity assessment procedures which have the effect of prohibiting, restricting or increasing the burden for the importation and putting into service on their domestic market of products type-approved under UN Regulations for the areas covered by those UN Regulations unless such domestic technical regulations, markings or conformity assessment procedures are explicitly provided for by those UN Regulations.

#### Article 6: Type approval and market surveillance

1 Each Party shall accept on its market products which are covered by a valid UN type-approval certificate as compliant with its domestic technical regulations, markings and conformity assessment procedures, without requiring any further testing or marking to verify or attest compliance with any requirement covered by the UN type approval certificate concerned. In the case of vehicle approvals, the UN Universal International Whole Vehicle Type Approval (U-IWVTA) shall be considered valid in respect of the requirements covered by the U-IWVTA. UN type-approval certificates issued by a Party can only be considered valid if that Party has acceded to the relevant UN Regulations.

2 Each Party shall only be required to accept valid UN type-approval certificates issued pursuant to the latest version of the UN Regulations it has acceded to.

3. For the purpose of paragraph 1, the following shall be considered sufficient proof of the existence of a valid UN type-approval:

- (a) for whole vehicles, a valid UN Declaration of Conformance certifying compliance with a U-IWVTA;
- (b) for equipment and parts, a valid UN type-approval mark affixed to the product; or
- (c) for equipment and parts to which a UN type-approval mark cannot be affixed, a valid UN type-approval certificate.

4. For the purpose of conducting market surveillance, the competent authorities of a Party may verify that the products covered comply, as appropriate, with

- (a) all the domestic technical regulations of that Party; or
- (b) the UN Regulations with which compliance has been attested, in accordance with this Article, by a valid UN Declaration of Conformance certifying compliance with a U-IWVTA in the case of whole vehicles, or by a valid UN type-approval mark affixed to the product or a valid UN type-approval certificate in the case of equipment and parts.

Such verifications shall be carried out by random sampling in the market and in accordance with the technical regulations referred to in point (a) or (b) of this paragraph, as the case may be.

5. The Parties shall endeavour to cooperate in the field of market surveillance to support the identification and addressing of non-conformities of vehicles, systems, components or separate technical units.

6. A Party may take any appropriate measures with respect to vehicles, systems, components or separate technical units that present a serious risk to the health or safety of persons or with regard to other aspects of the protection of public interests, or that otherwise do not comply with applicable requirements. Such measures may include prohibiting or restricting the making available on the market, the registration or the entry into service of the vehicles, systems, components or separate technical units concerned, or withdrawing them from the market or recalling them. A Party that adopts or maintains such measures shall promptly inform the other Party of those measures and, at the request of the other Party, shall provide its reasons for adopting those measures.

#### Article 7: Products with new technologies or new features

1. Neither Party shall refuse or restrict the access to its market of a product that is covered by this Annex and that has been approved by the exporting Party on the grounds that the product incorporates a new technology or a new feature that the importing Party has not yet regulated, unless it can demonstrate that it has reasonable grounds for believing that the new technology or new feature creates a risk for human health, safety or the environment.

2. If a Party decides to refuse the access to its market or requires the withdrawal from its market of a product of the other Party covered by this Annex on the grounds that it incorporates a new technology or a new feature creating a risk for human health, safety or the environment, it shall promptly notify that decision to the other Party and to the economic operator or operators concerned. The notification shall include all relevant scientific or technical information taken into account in the decision.

#### Article 8: Cooperation

1. In order to further facilitate trade in motor vehicles, their parts and equipment, and to prevent market access problems, while ensuring human health, safety and environmental protection, the Parties shall endeavour to cooperate and to exchange information as appropriate.

2. Areas of cooperation under this Article may include in particular:

- (a) the development and establishment of technical regulations or related standards;
- (b) the exchange, to the extent possible, of research, information and results linked to the development of new vehicle safety regulations or related standards, advanced emission reduction, and emerging vehicle technologies;
- (c) the exchange of available information on the identification of safety-related or emission-related defects and non-compliance with technical regulations; and
- (d) the promotion of greater international harmonisation of technical requirements through multilateral fora, such as the 1958 Agreement and the 1998 Agreement, including through cooperation in the planning of initiatives in support of such harmonisation.

## Article 9: Working Group on Motor Vehicles and Parts

1. A Working Group on Motor Vehicles and Parts shall assist the Trade Specialised Committee on Technical Barriers to Trade in monitoring and reviewing the implementation and ensuring the proper functioning of this Annex.
2. The functions of the Working Group on Motor Vehicles and Parts shall be the following:
  - (a) discussing any matter arising under this Annex, on request of a Party;
  - (b) facilitating cooperation and exchange of information in accordance with Article 8;
  - (c) carrying out technical discussions in accordance with Article TBT.10 [Technical discussions] of this Agreement on matters falling within the scope of this Annex; and
  - (d) maintaining a list of contact points responsible for matters arising under this Annex.

## ANNEX TBT-2: MEDICINAL PRODUCTS

### Article 1: Definitions

1. For the purposes of this Annex:
  - (a) "authority" means an authority of a Party as listed in Appendix A;
  - (b) "Good Manufacturing Practice" or "GMP" means that part of quality assurance which ensures that products are consistently produced and controlled in accordance with the quality standards appropriate for their intended use and as required by the applicable marketing authorisation or product specifications, as listed in Appendix B;
  - (c) "inspection" means an evaluation of a manufacturing facility to determine whether such manufacturing facility is operating in compliance with Good Manufacturing Practice and/or commitments made as part of the approval to market a product, which is conducted in accordance with the laws, regulations and administrative provisions of the relevant Party, and includes pre-marketing and post-marketing inspection;
  - (d) "official GMP document" means a document issued by an authority of a Party following the inspection of a manufacturing facility, including, for example, inspection reports, certificates attesting the compliance of a manufacturing facility with GMP, or a GMP non-compliance statement.

### Article 2: Scope

The provisions of this Annex apply to medicinal products as listed in Appendix C.

### Article 3: Objectives

With regard to the products covered the objectives of this Annex are:

- (a) to facilitate the availability of medicines in each Party's territory;
- (b) to set out the conditions for the recognition of inspections and for the exchange and acceptance of official GMP documents between the Parties;
- (c) to promote public health by safeguarding patient safety and animal health and welfare, as well as to protect high levels of consumer and environmental protection, where relevant, by promoting regulatory approaches in line with the relevant international standards.

### Article 4: International standards

The relevant standards for the products covered by this Annex shall ensure a high level of protection of public health in line with standards, practices and guidelines developed by the World Health Organization (WHO), the Organization for Economic Cooperation and Development (OECD), the International Council for Harmonisation of Technical Requirements for Pharmaceuticals for Human Use (ICH), and the International Cooperation on Harmonisation of Technical Requirements for Registration of Veterinary Medicinal Products (VICH).

### Article 5: Recognition of inspections and acceptance of official GMP documents

1. A Party shall recognise inspections carried out by the other Party and shall accept official GMP documents issued by the other Party in accordance with the laws, regulations and technical guidelines listed in Appendix B.

2. An authority of a Party may in specific circumstances opt not to accept an official GMP document issued by an authority of the other Party for manufacturing facilities located in the territory of the issuing authority. Examples of such circumstances include the indication of material inconsistencies or inadequacies in an inspection report, quality defects identified in post-market surveillance or other specific evidence of serious concern in relation to product quality or patient safety. Each Party shall ensure that where an authority of a Party opts not to accept an official GMP document issued by an authority of the other Party, that authority notifies the relevant authority of the other Party of the reasons for not accepting the document and may request clarification from the authority of the other Party. The relevant Party shall ensure that its authority endeavours to respond to the request for clarification in a timely manner.

3. A Party may accept official GMP documents issued by an authority of the other Party for manufacturing facilities located outside the territory of the issuing authority.

4. Each Party may determine the terms and conditions under which it accepts official GMP documents issued under paragraph 3.

#### Article 6: Exchange of official GMP documents

1. Each Party shall ensure that if an authority of a Party requests an official GMP document from the authority of the other Party, the authority of the other Party shall endeavour to transmit the document within 30 calendar days of the date of the request.

2. Each Party shall treat the information in a document obtained pursuant to paragraph 1 as confidential.

#### Article 7: Safeguards

1. Each Party has the right to conduct its own inspection of manufacturing facilities that have been certified as compliant by the other Party.

2. Each Party shall ensure that, prior to conducting an inspection under paragraph 1, the authority of the Party that intends to conduct the inspection notifies the relevant authority of the other Party of the inspection in writing, stating the reasons for conducting its own inspection. The authority of the Party that intends to conduct the inspection shall endeavour to notify the authority of the other Party in writing at least 30 days before a proposed inspection, but may provide a shorter notice in urgent situations. The authority of the other Party may join the inspection.

#### Article 8 – Changes to applicable laws and regulations

1. Each Party shall notify the other Party at least 60 days before adopting any new measures or changes relating to Good Manufacturing Practice concerning any of the relevant laws, regulations and technical guidelines listed in Appendix B.

2. The Parties shall exchange all the necessary information, including changes to their respective laws, regulations, technical guidelines or inspection procedures relating to Good Manufacturing Practice so that each Party can consider whether the conditions for the recognition of inspections and acceptance of official GMP documents pursuant to Article 5(1) continue to exist.

3. If as a result of any of the new measures or changes referred to in paragraph 1 of this Article, a Party considers that it can no longer recognise inspections or accept official GMP documents issued by the other Party, it shall notify the other Party of its intention to apply Article 9 and the Parties shall enter into consultations within the Working Group on Medicinal Products.

4. Any notification under this Article shall be done via the designated contact points in the Working Group on Medicinal Products.

#### Article 9: Suspension

1. Without prejudice to Article 5(2), each Party has the right to suspend totally or partially the recognition of inspections and acceptance of official GMP documents of the other Party pursuant to Article 5(1) for all or some of the products listed in Appendix C. That right shall be exercised in an objective and reasoned manner. The Party exercising such right shall notify the other Party and provide a written justification. A Party shall continue to accept official GMP documents of the other Party issued prior to such suspension, unless the Party decides otherwise on the basis of health or safety considerations.

2. Where, following consultations referred to in Article 8(3), a Party nevertheless suspends the recognition of inspections and acceptance of official GMP documents pursuant to Article 5(1), it may do so in accordance with paragraph 1 of this Article not earlier than 60 days after the commencement of the consultations. During that 60-day period, both Parties shall continue to recognise inspections and accept official GMP documents issued by an authority of the other Party.

3. Where recognition of inspections and acceptance of official GMP documents pursuant to Article 5(1) is suspended, at the request of a Party, the Parties shall discuss the matter within the Working Group on Medicinal Products and they shall make every effort to consider possible measures that would enable the recognition of inspections and acceptance of official GMP documents to be restored.

#### Article 10: Regulatory cooperation

1. The Parties shall endeavour to consult one another, as permitted by their respective law, on proposals to introduce significant changes to technical regulations or inspection procedures, including those that affect how documents from the other Party are recognised in accordance with Article 5 and, where appropriate, to provide the opportunity to comment on such proposals, without prejudice to Article 8.

2. The Parties shall endeavour to cooperate with a view to strengthening, developing and promoting the adoption and implementation of internationally agreed scientific or technical guidelines including, where feasible, through the presentation of joint initiatives, proposals and approaches in the relevant international organisations and bodies referred to in Article 4.

#### Article 11: Amendments to appendices

The Partnership Council shall have the power to amend Appendix A in order to update the list of authorities, Appendix B in order to update list of applicable laws and regulations and technical guidelines, and Appendix C in order to update the list of covered products.

#### Article 12: Working Group on Medicinal Products

1. The Working Group on Medicinal Products shall assist the Trade Specialised Committee on Technical Barriers to Trade in monitoring and reviewing the implementation and ensuring the proper functioning of this Annex.
2. The functions of this Working Group shall be the following:
  - (a) discussing any matter arising under this Annex at the request of a Party;
  - (b) facilitating cooperation and exchanges of information for the purposes of Articles 8 and 10;
  - (c) functioning as the forum for consultations and discussions for the purposes of Articles 8 (3) and 9(3)
  - (d) carrying out technical discussions in accordance with Article TBT.10 [Technical discussions] of this Agreement on matters falling within the scope of this Annex; and
  - (e) maintaining a list of contact points responsible for matters arising under this Annex.

#### Article 13 : Non-application of dispute settlement

Title I [Dispute settlement] of Part Six of this Agreement does not apply in respect of disputes regarding the interpretation and application of this Annex.



## APPENDIX A – AUTHORITIES of the Parties

### 1) European Union:

Country	For medicinal products for human use	For medicinal products for veterinary use
<b>Belgium</b>	Federal agency for medicines and health products /  Federaal Agentschap voor geneesmiddelen en gezondheidsproducten/ Agence fédérale des médicaments et produits de santé	See authority for medicinal products for human use
<b>Bulgaria</b>	Bulgarian Drug Agency /  ИЗПЪЛНИТЕЛНА АГЕНЦИЯ ПО ЛЕКАРСТВАТА	Bulgarian Food Safety Agency/  Българска агенция по безопасност на храните
<b>Czechia</b>	State Institute for Drug Control/  Státní ústav pro kontrolu léčiv (SÚKL)	Institute for State Control of Veterinary Biologicals and Medicaments /  Ústav pro státní kontrolu veterinárních biopreparátů a léčiv (ÚSKVBL)
<b>Denmark</b>	Danish Medicines Agency/  Laegemiddelstyrelsen	See authority for medicinal products for human use

<b>Germany</b>	Federal Institute for Drugs and Medical Devices /	Federal Office for Consumer Protection and Food Safety /
	Bundesinstitut für Arzneimittel und Medizinprodukte (BfArM)	Bundesamt für Verbraucherschutz und Lebensmittelsicherheit (BVL)
	Paul-Ehrlich-Institute (PEI), Federal Institute for Vaccines and Biomedicines / Paul-Ehrlich-Institut (PEI) Bundesinstitut für Impfstoffe und biomedizinische Arzneimittel	Federal Ministry of Food and Agriculture, Bundesministerium für Ernährung und Landwirtschaft
	Federal Ministry of Health / Bundesministerium für Gesundheit (BMG)/ Zentralstelle der Länder für Gesundheitsschutz bei Arzneimitteln und Medizinprodukten (ZLG) <sup>97</sup>	
<b>Estonia</b>	State Agency of Medicines / Ravimiamet	See authority for medicinal products for human use
<b>Ireland</b>	Health Products Regulatory Authority (HPRA)	See authority for medicinal products for human use
<b>Greece</b>	National Organisation for Medicines /  Ethnikos Organismos Farmakon (EOF) - (ΕΘΝΙΚΟΣ ΟΡΓΑΝΙΣΜΟΣ ΦΑΡΜΑΚΩΝ)	See authority for medicinal products for human use
<b>Spain</b>	Spanish Agency of Medicines and Medical Devices /  Agencia Española de Medicamentos y Productos Sanitarios <sup>98</sup>	See authority for medicinal products for human use

---

<sup>97</sup> For the purpose of this Annex, and without prejudice to the internal division of competence in Germany on matters falling within the scope of this Annex, ZLG shall be understood as covering all the competent Länder authorities issuing GMP documents and conducting pharmaceutical inspections.

<sup>98</sup> For the purpose of this Annex, and without prejudice to the internal division of competence in Spain on matters falling within the scope of this Annex, Agencia Española de Medicamentos y Productos Sanitarios shall be understood as covering all the competent regional authorities issuing official GMP documents and conducting pharmaceutical inspections.

<b>France</b>	French National Agency for Medicines and Health Products Safety Agence nationale de sécurité du médicament et des produits de santé (ANSM)	French agency for food, environmental and occupational health safety- <i>National Agency for Veterinary Medicinal Products/</i>  Agence Nationale de Sécurité Sanitaire de l'alimentation, de l'environnement et du travail-Agence Nationale du Médicament Vétérinaire (Anses-ANMV)
<b>Croatia</b>	Agency for Medicinal Products and Medical Devices /  Agencija za lijekove i medicinske proizvode (HALMED)	Ministry of Agriculture, Veterinary and Food Safety Directorate /  Ministarstvo Poljoprivrede, Uprava za veterinarstvo i sigurnost hrane
<b>Italy</b>	<i>Italian Medicines Agency / Agenzia Italiana del Farmaco</i>	<i>Direction General for Animal Health and Veterinary Medicinal Products</i>  Ministero della Salute, Direzione Generale della Sanità Animale e dei Farmaci Veterinari
<b>Cyprus</b>	Ministry of Health - Pharmaceutical Services /  Φαρμακευτικές Υπηρεσίες, Υπουργείο Υγείας	Ministry of Agriculture, Rural Development and Environment-  Veterinary Services /  Κτηνιατρικές Υπηρεσίες- Υπουργείο Γεωργίας, Αγροτικής Ανάπτυξης και Περιβάλλοντος
<b>Latvia</b>	State Agency of Medicines /  Zāļu valsts aģentūra	Assessment and Registration Department of the Food and Veterinary Service/Pārtikas un veterinārā dienesta Novērtēšanas un reģistrācijas departaments
<b>Lithuania</b>	State Medicines Control Agency /  Valstybinė vaistų kontrolės tarnyba	State Food and Veterinary Service /  Valstybinės maisto ir veterinarijos tarnyba
<b>Luxembourg</b>	Ministère de la Santé, Division de la	See authority for medicinal products

	Pharmacie et des Médicaments	for human use
<b>Hungary</b>	Országos Gyógyszerészeti és Élelmezés-egészségügyi Intézet / National Institute of Pharmacy and Nutrition	National Food Chain Safety Office, Directorate of Veterinary Medicinal Products / Nemzeti Élelmiszerlánc- biztonsági Hivatal,  Állatgyógyászati Termékek Igazgatósága (ÁTI)
<b>Malta</b>	Medicines Regulatory Authority	Veterinary Medicines Section of the National Veterinary Laboratory (NVL) within  The Animal Health and Welfare Department (AHWD)
<b>Netherlands</b>	Healthcare and Youth Inspectorate / Inspectie Gezondheidszorg en Youth (IGJ)	Medicines Evaluation Board /  Bureau Diergeneesmiddelen, College ter Beoordeling van Geneesmiddelen (CBG)
<b>Austria</b>	Austrian Agency for Health and Food Safety /  Österreichische Agentur für Gesundheit und Ernährungssicherheit GmbH	See authority for medicinal products for human use
<b>Poland</b>	The Main Pharmaceutical Inspectorate /  Główny Inspektorat Farmaceutyczny (GIF) /	See authority medicinal products for human use
<b>Portugal</b>	National Authority of Medicines and Health Products /  INFARMED, I.P  Autoridade Nacional do Medicamento e Produtos de Saúde, I.P	General Directorate of Food and Veterinary / DGAV - Direção Geral de Alimentação e Veterinária (PT)
<b>Romania</b>	National Agency for Medicines and Medical Devices /	National Sanitary Veterinary and Food Safety Authority / Autoritatea Națională Sanitară Veterinară și

Agenția Națională a Medicamentului și a Dispozitivelor Medicale pentru Siguranța Alimentelor

<b>Slovenia</b>	Agency for Medicinal Products and Medical Devices of the Republic of Slovenia / Javna agencija Republike Slovenije za zdravila in medicinske pripomočke (JAZMP)	See authority for medicinal products for human use
<b>Slovakia</b>	State Institute for Drug Control / Štátny ústav pre kontrolu liečiv (ŠÚKL)	Institute for State Control of Veterinary Biologicals and Medicaments / Ústav štátnej kontroly veterinárnych biopreparátov a liečiv (USKVBL)
<b>Finland</b>	Finnish Medicines Agency / Lääkealan turvallisuus- ja kehittämiskeskus (FIMEA)	See authority for medicinal products for human use
<b>Sweden</b>	Medical Products Agency / Läkemedelsverket	See authority for medicinal products for human use

## 2) United Kingdom

Medicines and Healthcare Products Regulatory Agency

Veterinary Medicines Directorate

## APPENDIX B – List of applicable laws, regulations and technical guidelines relating to Good Manufacturing Practice

(1) For the European Union:

Directive 2001/83/EC of the European Parliament and of the Council of 6 November 2001 on the Community code relating to medicinal products for human use;<sup>99</sup>

Directive 2001/82/EC of the European Parliament and of the Council of 6 November 2001 on the Community code relating to veterinary medicinal products;<sup>100</sup>

Directive 2001/20/EC of European Parliament and of the Council of 4 April 2001 on the approximation of the laws, regulations and administrative provisions of the Member States relating to the implementation of good clinical practice in the conduct of clinical trials on medicinal products for human use;<sup>101</sup>

Regulation (EU) 536/2014 of 16 April 2014 on clinical trials on medicinal products for human use, and repealing Directive 2001/20/EC;<sup>102</sup>

Regulation (EC) No 726/2004 of the European Parliament and of the Council of 31 March 2004 laying down Community procedures for the authorisation and supervision of medicinal products for human and veterinary use and establishing a European Medicines Agency;<sup>103</sup>

Regulation (EC) No 1394/2007 of the European Parliament and of the Council of 13 November 2007 on advanced therapy medicinal products and amending Directive 2001/83/EC and Regulation (EC) No 726/2004;<sup>104</sup>

Commission Directive 2003/94/EC of 8 October 2003 laying down the principles and guidelines of good manufacturing practice in respect of medicinal products for human use and investigational medicinal products for human use;<sup>105</sup>

Commission Directive 91/412/EEC of 23 July 1991 laying down the principles and guidelines of good manufacturing practice for veterinary medicinal products;<sup>106</sup>

Commission Directive (EU) 2017/1572 of 15 September 2017 supplementing Directive 2001/83/EC of the European Parliament and of the Council as regards the principles and guidelines of good manufacturing practice for medicinal products for human use;<sup>107</sup>

Commission Delegated Regulation (EU) 1252/2014 of 28 May 2014 of the European Parliament and of the Council with regard to principles and guidelines of good manufacturing practice for active substances for medicinal products for human use;<sup>108</sup>

---

<sup>99</sup> OJ L 311, 28.11.2001, p. 67.

<sup>100</sup> OJ L 311, 28.11.2001, p. 1.

<sup>101</sup> OJ L 121, 1.5.2001, p. 34.

<sup>102</sup> OJ L 158, 27.5.2014, p. 1.

<sup>103</sup> OJ L 136, 30.4.2004, p. 1

<sup>104</sup> OJ L 324, 10.12.2007, p. 121.

<sup>105</sup> OJ L 262, 14.10.2003, p. 22.

<sup>106</sup> OJ L 228, 17.8.1991, p. 70.

<sup>107</sup> OJ L 238, 16.9.2017, p. 44.

Commission Delegated Regulation (EU) 2017/1569 of 23 May 2017 supplementing Regulation (EU) No 536/2014 of the European Parliament and of the Council by specifying principles of and guidelines for good manufacturing practice for investigational medicinal products for human use and arrangements for inspections;<sup>109</sup>

Current version of the Guide to good manufacturing practice contained in volume IV of Rules governing medicinal products in the European Union and compilation of the community procedures on inspections and exchange of information.

(2) For the United Kingdom:

The Human Medicines Regulations 2012 (SI 2012/1916)

The Medicines for Human Use (Clinical Trials) Regulations 2004 (SI 2004/1031)

The Veterinary Medicines Regulations 2013 (SI 2013/2033)

Regulations on good manufacturing practice made under regulation B17, and guidelines on good manufacturing practice published pursuant to regulation C17, of the Human Medicines Regulations 2012

The principles and guidelines on good manufacturing practice applicable for the purposes of Schedule 2 to the Veterinary Medicines Regulations 2013

---

<sup>108</sup> OJ L 337, 25.11.2014, p. 1.

<sup>109</sup> OJ L 238, 16.9.2017, p. 12.

## **APPENDIX C – COVERED PRODUCTS**

Medicinal products for human use and veterinary use:

- marketed medicinal products for human or veterinary use, including marketed biological and immunological products for human and veterinary use,
- advanced therapy medicinal products,
- active pharmaceutical ingredients for human or veterinary use,
- investigational medicinal products.



## ANNEX TBT-3: CHEMICALS

### Article 1: Definitions

For the purposes of this Annex:

- (a) “responsible authorities” means
  - (i) For the Union: the European Commission;
  - (ii) For the United Kingdom: the government of the United Kingdom.
- (b) “UN GHS” means the United Nations Globally Harmonized System of Classification and Labelling of Chemicals.

### Article 2: Scope

This Annex applies to the trade, regulation, import and export of chemicals between the Union and the United Kingdom in respect of their registration, evaluation, authorisation, restriction, approval, classification, labelling and packaging.

### Article 3: Objectives

1. The objectives of this Annex are to:
  - (a) facilitate the trade of chemicals and related products between the Parties;
  - (b) ensure high levels of protection for the environment, and human and animal health; and
  - (c) provide for cooperation between Union and United Kingdom responsible authorities.
2. The Parties acknowledge that the commitments made under this Annex do not prevent either Party from setting its own priorities on chemicals regulation, including establishing its own levels of protection in respect of the environment, and human and animal health.

### Article 4: Relevant international organisations and bodies

The Parties recognise that international organisations and bodies, in particular the OECD and the Sub-Committee of Experts on the Globally Harmonized System of Classification and Labelling of Chemicals (SCEGHS) of the United Nations Economic and Social Council (ECOSOC), are relevant for developing scientific and technical guidelines with respect to chemicals.

### Article 5: Participation in relevant international organisations and bodies and regulatory developments

1. The Parties shall actively contribute to the development of the scientific or technical guidelines referred to in Article 4 with respect to the assessment of hazards and risks of chemicals and the formats for documenting the results of such assessments.
2. Each Party shall implement any guidelines issued by the international organisations and bodies referred to in Article 4, unless those guidelines would be ineffective or inappropriate for the achievement of that Party’s legitimate objectives.

## Article 6: Classification and labelling of chemicals

1. Each Party shall implement the UN GHS as comprehensively as it considers feasible within its respective system, including for chemicals that are not within the scope of this Annex, except where there are specific reasons to apply a different labelling system for particular chemical products in their finished state intended for the final user. Each Party shall periodically update its implementation based on the regularly issued revisions of the UN GHS.
2. Where the responsible authority of a Party intends to classify individual substances in accordance with its respective rules and procedures, it shall give the responsible authority of the other Party the possibility of expressing its views in accordance with those respective rules and procedures within the applicable timelines.
3. Each Party shall make information about its procedures related to the classification of substances publicly available in accordance with its respective rules and procedures. Each Party shall endeavour to respond to comments received from the other Party pursuant to paragraph 2.
4. Nothing in this Article shall oblige either Party to achieve any particular outcome regarding the implementation of the UN GHS in its territory or regarding the classification of a given substance, or to advance, suspend or delay its respective procedures and decision-making processes.

## Article 7: Cooperation

1. The Parties recognise that voluntary cooperation on chemicals regulation can facilitate trade in ways that benefit consumers, businesses and the environment and that contribute to enhancing the protection of human and animal health.
2. The Parties commit to facilitating the exchange of non-confidential information between their responsible authorities, including through cooperation on electronic formats and tools used to store data.
3. The Parties shall cooperate where appropriate with a view to strengthening, developing and promoting the adoption and implementation of internationally agreed scientific or technical guidelines, including, where feasible, through the presentation of joint initiatives, proposals and approaches in the relevant international organisations and bodies, in particular those referred to in Article 4.
4. The Parties shall cooperate, if considered beneficial by both Parties, with regard to the dissemination of data related to chemicals safety, and shall make such information available to the public with the objective of ensuring easy access to and the comprehensibility of that information by different target groups. Upon request of either Party, the other Party shall provide available non-confidential information on chemicals safety to the requesting Party.
5. If a Party so requests and the other Party agrees to do so, the Parties shall enter into consultations on scientific information and data in the context of new and emerging issues related to the hazards or risks posed by chemicals to human health or the environment, with a view to creating a common pool of knowledge and, if feasible, and to the extent possible, promoting a common understanding of the science related to such issues.

## Article 8: Information exchange

- The Parties shall cooperate and exchange information with respect to any issue relevant for the implementation of this Annex within the Trade Specialised Committee on Technical Barriers to Trade.

## ANNEX TBT-4: ORGANIC PRODUCTS

### Article 1: Objective and scope

1. The objective of this Annex is to set out the provisions and procedures for fostering trade in organic products in accordance with the principles of non-discrimination and reciprocity, by means of the recognition of equivalence by the Parties of their respective laws.
2. This Annex applies to the organic products listed in Appendices A and B which comply with the laws and regulations listed in Appendix C or D. The Partnership Council shall have the power to amend Appendices A, B, C and D.

### Article 2: Definitions

For the purposes of this Annex:

“competent authority” means an official agency that has jurisdiction over the laws and regulations listed in Appendix C or D and is responsible for the implementation of this Annex;

“control authority” means an authority on which the competent authority has conferred, in whole or in part, its competence for inspections and certifications in the field of organic production in accordance with the laws and regulations listed in Appendix C or D;

“control body” means an entity recognised by the competent authority to carry out inspections and certifications in the field of organic production in accordance with the laws and regulations listed in Appendix C or D; and

"equivalence" means the capability of different laws, regulations and requirements, as well as inspection and certification systems, of meeting the same objectives.

### Article 3: Recognition of equivalence

1. With respect to products listed in Appendix A, the Union shall recognise the laws and regulations of the United Kingdom listed in Appendix C as equivalent to the Union's laws and regulations listed in Appendix D.
2. With respect to products listed in Appendix B, the United Kingdom shall recognise the laws and regulations of the Union listed in Appendix D as equivalent to the United Kingdom's laws and regulations listed in Appendix C.
3. In view of the date of application of 1 January 2022 of Regulation (EU) 2018/848 of the European Parliament and of the Council of 30 May 2018 on organic production and labelling of organic products and repealing Council Regulation (EC) No 834/2007, the recognition of equivalence referred to in paragraphs 1 and 2 shall be reassessed by each Party by 31 December 2023. If, as a result of that reassessment, equivalence is not confirmed by a Party, recognition of equivalence shall be suspended.
4. Without prejudice to paragraph 3, in the event of the modification, revocation or replacement of the laws and regulations listed in Appendix C or D, the new rules shall be considered equivalent to the other Party's rules unless a Party objects in accordance with the procedure set out in paragraphs 5 and 6.

5. If, following the receipt of further information from the other Party that it has requested, a Party considers that the laws, regulations or administrative procedures or practices of the other Party no longer meet the requirements for equivalence, that Party shall issue a reasoned request to the other Party to amend the relevant laws, regulations or administrative procedures or practices, and shall provide the other Party with an adequate period, which shall not be less than three months, for ensuring equivalence.

6. If, following the expiry of the period in paragraph 5, the Party concerned still considers that the requirements for equivalence are not met, it may take a decision to unilaterally suspend the recognition of equivalence of the relevant laws and regulations listed in Appendix C or D, as regards the relevant organic products listed in Appendix A or B.

7. A decision to unilaterally suspend the recognition of equivalence of the laws and regulations listed in Appendix C or D, as regards the relevant organic products listed in Appendix A or B may also be taken, following the expiry of a notice period of three months, where a Party has not provided the information required under Article 6 or does not agree to a peer review under Article 7.

8. Where recognition of equivalence is suspended in accordance with this Article, at the request of a Party, the Parties shall discuss the matter within the Working Group on Organic Products and they shall make every effort to consider possible measures that would enable recognition of equivalence to be restored.

9. With respect to products not listed in Appendix A or B, equivalence shall be discussed by the Working Group on Organic Products at the request of a Party.

#### Article 4: Import and placing on the market

1. The Union shall accept the import into its territory of the products listed in Appendix A, and the placing of those products on the market as organic products, provided that those products comply with the laws and regulations of the United Kingdom listed in Appendix C and are accompanied by a certificate of inspection issued by a control body recognised by the United Kingdom and indicated to the Union as referred to in paragraph 3.

2. The United Kingdom shall accept the import into its territory of the products listed in Appendix B, and the placing of those products on the market as organic products, provided that those products comply with the laws and regulations of the Union listed in Appendix D and are accompanied by a certificate of inspection issued by a control body recognised by the Union and indicated to the United Kingdom as referred to in paragraph 3.

3. Each Party recognises the control authorities or control bodies indicated by the other Party as responsible for performing the relevant controls as regards organic products covered by the recognition of equivalence as referred to in Article 3 and for issuing the certificate of inspection as referred to in paragraphs 1 and 2 of this Article with a view to their import into and placing on the market in the territory of the other Party.

4. The importing Party, in cooperation with the other Party, shall assign code numbers to each relevant control authority and control body indicated by the other Party.

## Article 5: Labelling

1. Products imported into the territory of a Party in accordance with this Annex shall meet the requirements for labelling set out in the laws and regulations of the importing Party listed in Appendices C and D. Those products may bear the Union's organic logo, any United Kingdom organic logo or both logos, as set out in the relevant laws and regulations, provided that those products comply with the labelling requirements for the respective logo or both logos.
2. The Parties undertake to avoid any misuse of the terms referring to organic production in relation to organic products that are covered by the recognition of equivalence under this Annex.
3. The Parties undertake to protect the Union's organic logo and any United Kingdom organic logo set out in the relevant laws and regulations against any misuse or imitation. The Parties shall ensure that the Union's organic logo and any United Kingdom organic logo are used only for the labelling, advertising or commercial documents of organic products that comply with the laws and regulations listed in Appendices C and -D.

## Article 6: Exchange of information

1. The Parties shall exchange all relevant information with respect to the implementation and application of this Annex. In particular, by 31 March of the second year following the entry into force of this Agreement, and by 31 March of each following year, each Party shall send to the other:
  - (a) a report that contains information with respect to the types and quantities of organic products exported under this Annex, covering the period from January to December of the previous year;
  - (b) a report on the monitoring and supervisory activities carried out by its competent authorities, the results obtained, and the corrective measures taken, covering the period from January to December of the previous year; and
  - (c) details of observed irregularities and infringements of the laws and regulations listed in Appendix C or D, as relevant.
2. Each Party shall inform the other Party without delay of:
  - (a) any update to the list of its competent authorities, control authorities and control bodies, including the relevant contact details (in particular the address and the internet address);
  - (b) any changes or repeals it intends to make in respect of laws or regulations listed in Appendix C or Appendix D, any proposals for new laws or regulations or any relevant proposed changes to administrative procedures and practices related to organic products covered by this Annex; and
  - (c) any changes or repeals it has adopted in respect of laws or regulations listed in Appendix C or Appendix D, any new legislation or relevant changes to administrative procedures and practices related to organic products covered by this Annex.

## Article 7: Peer reviews

1. Following advance notice of at least six months, each Party shall permit officials or experts designated by the other Party to conduct peer reviews in its territory to verify that the relevant control authorities and control bodies are carrying out the controls required to implement this Annex.
2. Each Party shall cooperate with and assist the other Party, to the extent permitted under the applicable law, in carrying out the peer reviews referred to in paragraph 1, which may include visits to offices of relevant control authorities and control bodies, processing facilities and certified operators.

## Article 8: Working Group on Organic Products

1. The Working Group on Organic Products shall assist the Trade Specialised Committee on Technical Barriers to Trade in monitoring and reviewing the implementation and ensuring the proper functioning of this Annex.
2. The functions of the Working Group on Organic Products shall be the following:
  - (a) discussing any matter arising under this Annex at the request of a Party, including any possible need for amendments to this Annex or any of its Appendices;
  - (b) facilitating cooperation regarding laws, regulations, standards and procedures concerning the organic products covered by this Annex, including discussions on any technical or regulatory issue related to rules and control systems; and
  - (c) carrying out technical discussions in accordance with Article TBT.10 [Technical discussions] of this Agreement on matters falling within the scope of this Annex.

## APPENDIX A

### ORGANIC PRODUCTS FROM THE UNITED KINGDOM FOR WHICH THE UNION RECOGNISES EQUIVALENCE

<b>Description</b>	<b>Comments</b>
Unprocessed plant products	
Live animals or unprocessed animal products	Includes Honey
Aquaculture products and seaweeds	
Processed agricultural products for use as food	
Processed agricultural products for use as feed	
Seeds and propagating material	

The organic products listed in this Appendix shall be unprocessed agricultural or aquaculture products produced in the United Kingdom or processed agricultural products for use as food or feed that have been processed in the United Kingdom with ingredients that have been grown in the United Kingdom or that have been imported into the United Kingdom in accordance with United Kingdom laws and regulations.



## APPENDIX B

### ORGANIC PRODUCTS FROM THE UNION FOR WHICH THE UNITED KINGDOM RECOGNISES EQUIVALENCE

<b>Description</b>	<b>Comments</b>
Unprocessed plant products	
Live animals or unprocessed animal products	Includes Honey
Aquaculture products and seaweeds	
Processed agricultural products for use as food	
Processed agricultural products for use as feed	
Seeds and propagating material	

The organic products listed in this Appendix shall be unprocessed agricultural or aquaculture products produced in the Union or processed agricultural products for use as food or feed that have been processed in the Union with ingredients that have been grown in the Union or that have been imported into the Union in accordance with the Union laws and regulations.

## APPENDIX C

### LAWS AND REGULATIONS ON ORGANIC PRODUCTS APPLICABLE IN THE UNITED KINGDOM<sup>110</sup>

The following laws and regulations applicable in the United Kingdom:

1. Retained REGULATION (EC) No 834/2007
2. Retained REGULATION (EC) No 889/2008
3. Retained REGULATION (EC) No 1235/2008
4. The Organic Products Regulations 2009

---

<sup>110</sup> References in this list to Retained Union law are deemed to be references to such legislation, as amended by the United Kingdom to apply to the United Kingdom.

## APPENDIX D

### LAWS AND REGULATIONS ON ORGANIC PRODUCTS APPLICABLE IN THE UNION

The following laws and regulations applicable in the Union:

1. Council Regulation (EC) No 834/2007 of 28 June 2007 on organic production and labelling of organic products and repealing Regulation (EEC) No 2092/91<sup>111</sup>
2. Commission Regulation (EC) No 889/2008 of 5 September 2008 laying down detailed rules for the implementation of Council Regulation (EC) No 834/2007 on organic production and labelling of organic products with regard to organic production, labelling and control<sup>112</sup>
3. Commission Regulation (EC) No 1235/2008 of 8 December 2008 laying down detailed rules for implementation of Council Regulation (EC) No 834/2007 as regards the arrangements for imports of organic products from third countries<sup>113</sup>

---

<sup>111</sup> OJ L 189, 20.7.2007, p. 1.

<sup>112</sup> OJ L 250, 18.9.2008, p. 1.

<sup>113</sup> OJ L 334, 12.12.2008, p. 25.

## *ANNEX-TBT-5: TRADE IN WINE*

### Article 1: Scope and definitions

1. This Annex applies to wine falling under Heading 22.04 of the Harmonised System.
2. For the purposes of this Annex, “wine produced in” means fresh grapes, grape must and grape must in fermentation that have been turned into wine or added to wine in the territory of the exporting Party.

### Article 2: Product definitions, oenological practices and processes

1. Oenological practices for wine recommended and published by the International Organisation of the Vine and Wine (“OIV”) shall be considered relevant international standards for the purposes of this Annex.
2. Each Party shall authorise the importation and sale for consumption of wine produced in the other Party, if that wine has been produced in accordance with:
  - (a) product definitions authorised in each Party under the laws and regulations referred to in Appendix A;
  - (b) the oenological practices established in each Party under the laws and regulations referred to in Appendix A that are in accordance with the relevant OIV standards; and
  - (c) Oenological practices and restrictions established in each Party that are not in accordance with the relevant OIV standards, listed in Appendix B.
3. The Partnership Council shall have the power to amend the Appendices referred to in paragraph 2.

### Article 3: Certification requirements on import in the respective territories of the Parties

1. For wine produced in a Party and placed on the market in the other Party, the documentation and certification that may be required by either Party shall be limited to a certificate, as set out in Appendix C, authenticated in conformity with the exporting Party’s laws and regulations.
2. A certificate required under paragraph 1 may take the form of an electronic document. Access to the electronic document or to the data necessary for its establishment shall be given by each Party on request of the competent authorities of the other Party where the goods are to be released into free circulation. If access to the relevant electronic systems is not available, the necessary data may also be requested in the form of a paper document.
3. The Partnership Council shall have the power to amend Appendix C.
4. The methods of analysis recognised as reference methods by the OIV and published by the OIV shall be the reference methods for the determination of the analytical composition of the wine in the context of control operations.

#### Article 4: Food information and lot codes

1. Unless otherwise specified in this Article, labelling of wine imported and marketed under this Agreement shall be conducted in compliance with the laws and regulations that apply in the territory of the importing Party.
2. A Party shall not require any of the following dates or their equivalent to appear on the container, label, or packaging of wine:
  - (a) the date of packaging;
  - (b) the date of bottling;
  - (c) the date of production or manufacture;
  - (d) the date of expiration, use by date, use or consume by date, expire by date;
  - (e) the date of minimum durability, best-by-date, best quality before date; or
  - (f) the sell-by-date.

By way of derogation from point (e) of the first subparagraph, a Party may require the display of a date of minimum durability on products that on account of the addition of perishable ingredients could have a shorter date of minimum durability than would normally be expected by the consumer.

3. Each Party shall ensure that a code is indicated on the label of packaged products that allows for the identification of the lot to which the product belongs, in accordance with the legislation of the Party exporting the packaged product. The lot code shall be easily visible, clearly legible and indelible. A Party shall not allow the marketing of packaged products which do not comply with the requirements set out in this paragraph.
4. Each Party shall permit mandatory information, including translations or an indication of the number of standard drinks or alcohol units whenever required, to be displayed on a supplementary label affixed to a wine container. Supplementary labels may be affixed to a wine container after importation but prior to the product being placed on the market in the Party's territory, provided that the mandatory information is fully and accurately displayed.
5. The importing Party shall not require the display on the label of allergens which have been used in the production of wine but are not present in the final product.

#### Article 5: Transitional measures

Wine which, at the date of entry into force of this Agreement, has been produced, described and labelled in accordance with the laws and regulations of a Party but in a manner that does not comply with this Annex, may continue to be labelled and placed on the market as follows:

- (a) by wholesalers or producers, for a period of two years from the entry into force of this Agreement; and
- (b) by retailers, until stocks are exhausted.

#### Article 6: Information exchange

The Parties shall cooperate and exchange information on any issue relevant for the implementation of this Annex within the Trade Specialised Committee on Technical Barriers to Trade.

#### Article 7: Review

No later than three years from the entry into force of this Agreement, the Parties shall consider further steps to facilitate trade in wine between the Parties.

## APPENDIX A – LAWS AND REGULATIONS OF THE PARTIES

### ***Laws and regulations of the United Kingdom***<sup>114</sup>

#### Laws and regulations referred to in Article 2(2) concerning:

- a) product definitions:
  - (i) Retained Regulation (EU) No 1308/2013, in particular production rules in the wine sector, in accordance with Articles 75, 81 and 91, Part IV of Annex II and Part II of Annex VII to that Regulation and its implementing rules, including subsequent modifications;
  - (ii) Retained Commission Delegated Regulation (EU) 2019/33, in particular Articles 47, 52 to 54 and Annexes III, V and VI to that Regulation, including subsequent modifications;
  - (iii) Retained Regulation (EU) No 1169/2011 and its implementing rules, including subsequent modifications;
- b) oenological practices and restrictions:
  - (i) Retained Regulation (EU) No 1308/2013, in particular oenological practices and restrictions in accordance with Articles 80 and 83 and Annex VIII to that Regulation and its implementing rules, including subsequent modifications;
  - (ii) Retained Commission Delegated Regulation (EU) 2019/934, including subsequent modifications.

### ***Laws and regulations of the Union:***

#### Laws and regulations referred to in Article 2(2) concerning:

- a) product definitions:
  - (i) Regulation (EU) No 1308/2013 of the European Parliament and of the Council<sup>115</sup>, in particular production rules in the wine sector, in accordance with Articles 75, 81 and 91, Part IV of Annex II and Part II of Annex VII to that Regulation and its implementing rules, including subsequent modifications;
  - (ii) Commission Delegated Regulation (EU) 2019/33<sup>116</sup>, in particular Articles 47, 52 to 54 and Annexes III, V and VI to that Regulation, including subsequent modifications;

---

<sup>114</sup> References in this list to Retained Union law are deemed to be references to such legislation, as amended by the United Kingdom to apply to the United Kingdom.

<sup>115</sup> Regulation (EU) No 1308/2013 of the European Parliament and of the Council of 17 December 2013 establishing a common organisation of the markets in agricultural products and repealing Council Regulations (EEC) No 922/72, (EEC) No 234/79, (EC) No 1037/2001 and (EC) No 1234/2007 (OJ L 347, 20.12.2013, p. 671).

<sup>116</sup> Commission Delegated Regulation (EU) 2019/33 of 17 October 2018 supplementing Regulation (EU) No 1308/2013 of the European Parliament and of the Council as regards applications for protection of designations of origin, geographical indications and traditional terms in the wine sector, the objection procedure, restrictions of use, amendments to product specifications, cancellation of protection, and labelling and presentation (OJ L 9, 11.1.2019, p. 2).

(iii) Regulation (EU) No 1169/2011 of the European Parliament and of the Council<sup>117</sup>, including subsequent modifications.

a) oenological practices and restrictions:

- (i) Regulation (EU) No 1308/2013, in particular oenological practices and restrictions in accordance with Articles 80 and 83 and Annex VIII to that Regulation and its implementing rules, including subsequent modifications;
- (ii) Commission Delegated Regulation (EU) 2019/934<sup>118</sup>, including subsequent modifications.

---

<sup>117</sup> Regulation (EU) No 1169/2011 of the European Parliament and of the Council of 25 October 2011 on the provision of food information to consumers, amending Regulations (EC) No 1924/2006 and (EC) No 1925/2006 of the European Parliament and of the Council, and repealing Commission Directive 87/250/EEC, Council Directive 90/496/EEC, Commission Directive 1999/10/EC, Directive 2000/13/EC of the European Parliament and of the Council, Commission Directives 2002/67/EC and 2008/5/EC and Commission Regulation (EC) No 608/2004 (OJ L 304, 22.11.2011, p. 18).

<sup>118</sup> Commission Delegated Regulation (EU) 2019/934 of 12 March 2019 supplementing Regulation (EU) No 1308/2013 of the European Parliament and of the Council as regards wine-growing areas where the alcoholic strength may be increased, authorised oenological practices and restrictions applicable to the production and conservation of grapevine products, the minimum percentage of alcohol for by-products and their disposal, and publication of OIV files (OJ L 149, 7.6.2019, p. 1).



APPENDIX B – ADDITIONAL OENOLOGICAL PRACTICES AND RESTRICTIONS JOINTLY ACCEPTED BY THE PARTIES

- (1) Concentrated grape must, rectified concentrated grape must and sucrose may be used for enrichment and sweetening under the specific and limited conditions set out in Part I of Annex VIII to Regulation (EU) No 1308/2013 and in Part I of Annex VIII to Retained Regulation (EU) No 1308/2013, subject to the exclusion of use of these products in a reconstituted form in wines covered by this Agreement.
- (2) The addition of water in winemaking is not allowed, except where required on account of a specific technical necessity.
- (3) Fresh lees may be used under the specific and limited conditions set out in line item 11.2 of Table 2 of Part A of Annex I to Commission Delegated Regulation (EU) 2019/934 and in line item 11.2 of Table 2 of Part A of Annex I to Retained Commission Delegated Regulation (EU) 2019/934.

APPENDIX C – TEMPLATE FOR SELF-CERTIFICATE FOR WINE IMPORTED FROM THE [EUROPEAN UNION / UNITED KINGDOM] INTO THE [UNITED KINGDOM / EUROPEAN UNION] (1)

1. Exporter (name and address)	2. Serial No (2)
3. Importer (name and address)	4. Competent authority at the place of dispatch in the [European Union / United Kingdom] (3)
5. Customs stamp (for official [European Union / United Kingdom] use only)	
6. Means of transport and transport details (4)	7. Place of unloading (if different from 3)
8. Description of the imported product (5)	9. Quantity in l/hl/kg
	10. Number of containers (6)
<p>11. Certificate</p> <p>‘The product described above is intended for direct human consumption and complies with the definitions and oenological practices authorised under Annex TBT-5: Trade in Wine to the Trade and Cooperation Agreement between the European Union and the European Atomic Energy Community, of the one part, and the United Kingdom of Great Britain and Northern Ireland, of the other part. It has been produced by a producer who is subject to inspection and supervision by the following competent authority (7):</p> <p>Consignor certifying the above information (8)</p> <p>Identification of the consignor (9)</p> <p>Place, date and signature of the consignor</p>	

- (1) In accordance with Article 3(1) of Annex TBT-5: Trade in Wine to the Trade and Cooperation Agreement between the European Union and the European Atomic Energy Community, of the one part, and the United Kingdom of Great Britain and Northern Ireland, of the other part.
- (2) Indicate the traceability number of the consignment, i.e. a serial number that identifies the consignment in the records of the exporter.
- (3) Indicate full name, address and contact details of the competent authority in one of the Member States of the European Union or in the United Kingdom from which the consignment is exported that is responsible for verifying the information referred to in this certificate.
- (4) Indicate transport used for delivery to the point of entry into the European Union or the United Kingdom; specify transport mode (ship, airplane, etc.), give name of the mean of transport (name of ship, number of flight, etc.)
- (5) Indicate the following information:
  - sale designation, as it appears on the label,
  - name of producer,
  - wine-growing region,
  - name of the country of production (one of the Member States of the European Union, or the United Kingdom),
  - name of the GI, if relevant,
  - total alcoholic strength by volume,
  - colour of the product (state 'red', 'rosé', 'pink' or 'white' only),
  - Combined Nomenclature code (CN code).
- (6) A container means a receptacle for wine of less than 60 litres. The number of containers may be the number of bottles.
- (7) Indicate full name, address and contact details of relevant competent authority in one of the Member States of the European Union or in the United Kingdom.
- (8) Indicate full name, address and contact details of the consignor.
- (9) Indicate:
  - For the European Union: the System of Exchange of Excise Data (SEED) excise number, or VAT number in case the consignor has no SEED number, or reference to the number in the list or register provided for in Article 8(3) of Commission Delegated Regulation (EU) 2018/273<sup>119</sup>;
  - For the United Kingdom: the System of Exchange of Excise Data (SEED) excise number, or VAT number in case the consignor has no SEED number, or reference to the WSB number.

---

<sup>119</sup> Commission Delegated Regulation (EU) 2018/273 of 11 December 2017 supplementing Regulation (EU) No 1308/2013 of the European Parliament and of the Council as regards the scheme of authorisations for vine plantings, the vineyard register, accompanying documents and certification, the inward and outward register, compulsory declarations, notifications and publication of notified information, and supplementing Regulation (EU) No 1306/2013 of the European Parliament and of the Council as regards the relevant checks and penalties, amending Commission Regulations (EC) No 555/2008, (EC) No 606/2009 and (EC) No 607/2009 and repealing Commission Regulation (EC) No 436/2009 and Commission Delegated Regulation (EU) 2015/560 (OJ L 58, 28.2.2018, p. 1).

**ANNEX TBT-XX – ARRANGEMENT REFERRED TO IN ARTICLE TBT.9(4) FOR THE REGULAR EXCHANGE  
OF INFORMATION IN RELATION TO THE SAFETY OF NON-FOOD PRODUCTS AND RELATED  
PREVENTIVE, RESTRICTIVE AND CORRECTIVE MEASURES**

*[This Annex shall establish an arrangement for the regular exchange of information between the Union's Rapid Alert System for non-food products (RAPEX), or its successor, and the United Kingdom's database relating to market surveillance and product safety established under the General Product Safety Regulations 2005, or its successor.]*

*In accordance with Article TBT.9(8), the arrangement shall specify the type of information to be exchanged, the modalities for the exchange and the application of confidentiality and personal data protection rules.]*

*ANNEX TBT-ZZ – ARRANGEMENT REFERRED TO IN ARTICLE TBT.9(5) FOR THE REGULAR EXCHANGE OF INFORMATION REGARDING MEASURES TAKEN ON NON-COMPLIANT NON-FOOD PRODUCTS, OTHER THAN THOSE COVERED BY ARTICLE TBT.9(4)*

*[This Annex shall establish an arrangement for the regular exchange of information, including the exchange of information by electronic means, regarding measures taken on non-compliant non-food products, other than those covered by Article TBT.9(4).*

*In accordance with Article TBT.9(8), the arrangement shall specify the type of information to be exchanged, the modalities for the exchange and the application of confidentiality and personal data protection rules.]*

## *ANNEX CUSTMS-1: AUTHORISED ECONOMIC OPERATORS*

### Article 1 Criteria for and treatment of Authorised Economic Operators

1. The specified criteria for qualification as an Authorised Economic Operator ("AEO") referred to in Article CUSTMS.9 [Authorised Economic Operators] of this Agreement, shall be established by the Parties' laws, regulations or procedures. The specified criteria, which shall be published, shall include:

(a) the absence of any serious infringement or repeated infringements of customs legislation and taxation rules, including no record of serious criminal offences relating to the economic activity of the applicant;

(b) the demonstration by the applicant of a high level of control of his or her operations and of the flow of goods, by means of a system of managing commercial and, where appropriate, transport records, which allows appropriate customs controls;

(c) financial solvency which shall be deemed to be proven where the applicant has good financial standing, which enables him or her to fulfil his or her commitments, with due regard to the characteristics of the type of business activity concerned; and

(d) appropriate security and safety standards which shall be considered as fulfilled where the applicant demonstrates that he or she maintains appropriate measures to ensure the security and safety of the international supply chain including in the areas of physical integrity and access controls, logistical processes and handling of specific types of goods, personnel and identification of his or her business partners.

2. The specified criteria for qualification as an AEO shall not be designed or applied so as to afford or create arbitrary or unjustifiable discrimination between operators where the same conditions prevail. Those criteria shall allow small and medium-sized enterprises to qualify as AEOs.

3. The trade partnership programme referred to in Article CUSTMS.9 [Authorised Economic Operators] of this Agreement shall include the following treatment:

(a) taking the AEO status granted by the other Party favourably into account in its risk assessment to reduce inspections or controls and in other security and safety-related measures;

(b) giving priority to the inspection of consignments covered by exit or entry summary declarations lodged by an AEO, if the customs authority decides to proceed with an inspection;

(c) taking the AEO status granted by the other Party into account with a view to treating the AEO as a secure and safe partner when assessing requirements concerning business partners for applicants under its own Programme; and

(d) endeavouring to establish a joint business continuity mechanism to respond to disruptions in trade flows due to increases in security alerts levels, border closures and/or natural disasters, hazardous emergencies or other major incidents where priority cargos related to AEOs could be facilitated and expedited to the extent possible by the customs authorities of the Parties.

## Article 2 Mutual recognition and responsibility for implementation

1. AEO Status under the trade partnership programmes of the Union and the United Kingdom are recognised to be compatible, and holders of the AEO status granted under each programme shall be treated in a manner consistent with Article 4.

2. The trade partnership programmes concerned are:

a) The European Union Authorised Economic operator (security and safety). (point (b) of Article 38(2) UCC); and

b) The United Kingdom Authorised Economic Operator programme (safety and security) (sub-paragraph (b) of Article 38(2) UCC, as retained in United Kingdom domestic law.)

3. The customs authorities, as defined in Article OTH.1(b) [Definitions] ("customs authorities"), are responsible for the implementation of the provisions in this Annex.

## Article 3 Compatibility

1. The Parties shall cooperate to maintain compatibility of the standards applied to each of their trade partnership programmes with respect to the following matters:

(a) the application process for granting the AEO status to operators;

(b) the assessment of AEO status applications;

(c) the granting of the AEO status; and

(d) the managing, monitoring, suspension and re-assessment, and revocation of the AEO status.

The Parties shall ensure that their customs authorities monitor AEOs' compliance with the relevant conditions and criteria.

2. The Parties shall complete a joint work programme setting out a minimum number of joint validations of holders of the AEO status granted under each trade partnership programme that must be completed by the end of 2021, at the latest.

3. The Parties shall ensure that their trade partnership programmes operate within the relevant standards of the SAFE Framework.

## Article 4 Treatment of status holders

1. Each Party shall provide comparable treatment to that given to AEOs under the other Party's trade partnership programme. This treatment shall include in particular the treatment set out in paragraph 3 of Article 1.

2. Each Party may suspend the treatment referred to in paragraph 3 of Article 1 to an AEO under the other Party's trade partnership programme under this Agreement if that AEO ceases to comply with the legal requirements. Such suspension shall be promptly communicated to the other customs authority together with any additional information regarding the basis for suspension, as appropriate.

3. Each Party shall promptly inform the other Party in cases where it identifies any irregularity committed by an AEO authorised by the other customs authority to allow it to take an informed decision on the possible revocation or suspension of the membership of the operator concerned.

#### Article 5 Exchange of information and communication

1. The Parties shall endeavour to communicate effectively with each other in the implementation of this Agreement. They shall exchange information and foster communication regarding their trade partnership programmes, in particular by:

(a) providing updates on the operation and development of their trade partnership programmes in a timely manner;

(b) engaging in mutually beneficial exchanges of information regarding supply chain security;

(c) designating the contact points for their respective trade partnership programmes and providing the contact details for those contact points to the other Party; and

(d) facilitating effective inter-agency communication between the European Commission's Directorate-General for Taxation and Customs Union and Her Majesty's Revenue and Customs to enhance risk management practices under their respective trade partnership programmes with respect to supply chain security on the part of AEOs.

2. Information and related data shall be exchanged in a systematic manner by electronic means.

3. The data to be exchanged regarding AEOs shall include:

(a) name;

(b) address;

(c) status of membership;

(d) validation or authorisation date;

(e) suspensions and revocations;

(f) the unique authorisation or identification number (in a form mutually determined by the customs authorities); and

(g) other details that may be mutually determined between the customs authorities, subject, where applicable, to any necessary safeguards.

The exchange of data shall commence with the entry into force of this Agreement.

4. The Parties shall use their best endeavours to establish, within six months of entry into force of this Agreement, an arrangement for fully automated exchange of the data referred to in paragraph 3, and in any event shall implement such an arrangement no later than one year after the entry into force of this Agreement.



## Article 6 Treatment of data

Any exchange of information between the Parties under this Annex shall be *mutatis mutandis* subject to the confidentiality and protection of information set out in Article 12 [Information exchange and confidentiality] of the Protocol on Mutual Administrative Assistance in Customs matters.

## Article 7 Consultation and Review

The Trade Specialised Committee on Customs Cooperation and Rules of Origin shall review the implementation of the provisions of this Annex regularly. That review shall include:

- (a) joint validations of AEOs granted status by each Party to identify strengths and weaknesses in implementing this Annex;
- (b) exchanges of views on data to be shared and treatment of operators.

## Article 8 Suspension and discontinuation

1. A Party may pursue the procedure set out in paragraph 2 in the event that either of the following circumstances arise:
  - a) Before or within three months of entry into force of this Agreement the other Party has made material changes to the legal provisions referred to in paragraph 2 of Article 2 that were assessed in order to establish that the trade partnership programmes are compatible, such that the compatibility required for recognition under paragraph 1 of Article 2 has ceased to exist;
  - b) The provisions under paragraph 2 of Article 5 [Exchange of information and communication] are not operational.
2. In the event that either of the circumstances set out in points (a) or (b) of paragraph 1 arise, a Party may suspend the recognition provided for in paragraph 1 of Article 2 [Mutual recognition and responsibility for implementation] 60 days after notifying the other Party of their intention.
3. Where a party gives notice of its intention to suspend the recognition provided for in paragraph 1 of Article 2 [Mutual recognition and responsibility for implementation] in accordance with paragraph 2 of this Article, the other Party may request consultations in the Trade Specialised Committee on Customs Cooperation and Rules of Origin. These consultations shall be held within 60 days of the request.
4. A Party may pursue the procedure set out in paragraph 5 in the event that either of the following circumstances arise:
  - a) The other Party changes its AEO programme or its implementation of this programme such that the compatibility required for recognition under paragraph 1 of Article 2 [Mutual recognition and responsibility for implementation] has ceased to exist;
  - b) The joint validations provided for in paragraph 2 of Article 3 [Compatibility] do not confirm the compatibility of the Parties' respective AEO programmes.

5. In the event that either of the circumstances set out in points (a) or (b) of paragraph 4 arise, a Party may request consultations with the other Party in the framework of the Trade Specialised Committee on Customs Cooperation and Rules of Origin. These consultations shall be held within 60 days from the request. If 90 days after the request a Party still considers that the compatibility required for recognition under paragraph 1 of Article 2 [Mutual recognition and responsibility for implementation] has ceased to exist, it may notify the other Party of its intention to suspend recognition of its programme. Suspension shall take effect 30 days after notification.

## ANNEX SERVIN-1: EXISTING MEASURES

### Headnotes

1. The Schedules of the United Kingdom and the Union set out, under Article SERVIN 2.7 [Non-conforming measures – Investment liberalisation], Article SERVIN.3.6 [Non-conforming measures – Cross-border trade in services], and Article SERVIN 5.50 [Non-conforming measures – Legal services] the reservations taken by the United Kingdom and the Union with respect to existing measures that do not conform with obligations imposed by:

- (a) Articles SERVIN.2.2 [Market access– Investment liberalisation] or SERVIN.3.2 [Market access - Cross-border trade in services];
- (b) Article SERVIN.3.3 [Local presence – Cross-border trade in services];
- (c) Articles SERVIN.2.3 [National treatment– Investment liberalisation] or SERVIN.3.4 [National treatment - Cross-border trade in services];
- (d) Articles SERVIN.2.4 [Most-favoured-nation treatment– Investment liberalisation], or SERVIN.3.5 [Most-favoured-nation treatment - Cross-border trade in services];
- (e) Article SERVIN.2.5 [Senior management and boards of directors];
- (f) Article SERVIN.2.6 [Performance requirements]; or
- (g) Article SERVIN.5.49 [Obligations – Legal services].

2. The reservations of a Party are without prejudice to the rights and obligations of the Parties under GATS.

3. Each reservation sets out the following elements:

- (a) "sector" refers to the general sector in which the reservation is taken;
- (b) "sub-sector" refers to the specific sector in which the reservation is taken;
- (c) "industry classification" refers, where applicable, to the activity covered by the reservation according to the CPC, ISIC Rev. 3.1, or as expressly otherwise described in that reservation;
- (d) "type of reservation" specifies the obligation referred to in paragraph 1 for which a reservation is taken;
- (e) "level of government" indicates the level of government maintaining the measure for which a reservation is taken;
- (f) "measures" identifies the laws or other measures as qualified, where indicated, by the "description" element for which the reservation is taken. A "measure" cited in the "measures" element:
  - (i) means the measure as amended, continued or renewed as of the date of entry into force of this Agreement;
  - (ii) includes any subordinate measure adopted or maintained under the authority of and consistent with the measure; and

(iii) in respect of the schedule of the European Union, includes any laws or other measures which implement a directive at Member State level; and

(g) "description" sets out the non-conforming aspects of the existing measure for which the reservation is taken.

4. For greater certainty, if a Party adopts a new measure at a level of government different to that at which the reservation was originally taken, and this new measure effectively replaces – within the territory to which it applies – the non-conforming aspect of the original measure cited in the ‘measures’ element, the new measure shall be deemed to constitute ‘modification’ to the original measure within the meaning of Article SERVIN.2.7(1)(c) [Non-conforming measures – Investment liberalisation]; Article SERVIN.3.6(1)(c) [Non-conforming measures – Cross-border trade in services]; Article 4.5(c) [Non-conforming measures – Entry and temporary stay of natural persons for business purposes] and Article SERVIN.5.50 [Non-conforming measures – Legal services].

5. In the interpretation of a reservation, all elements of the reservation shall be considered. A reservation shall be interpreted in the light of the relevant obligations of the Chapters or Sections against which the reservation is taken. The "measures" element shall prevail over all other elements.

6. For the purposes of the Schedules of the United Kingdom and the Union:

(a) “ISIC Rev. 3.1” means the International Standard Industrial Classification of All Economic Activities as set out in Statistical Office of the United Nations, Statistical Papers, Series M, No.4, ISIC Rev. 3.1, 2002;

(b) “CPC” means the Provisional Central Product Classification (Statistical Papers, Series M No. 77, Department of International Economic and Social Affairs, Statistical Office of the United Nations, New York, 1991).

7. For the purposes of the Schedules of the United Kingdom and the Union, a reservation for a requirement to have a local presence in the territory of the Union or the United Kingdom is taken against Article SERVIN 3.3 [Local presence], and not against Article SERVIN 3.2 [Market access] or SERVIN 3.4 [National treatment]. Furthermore, such a requirement is not taken as a reservation against Article SERVIN 2.3 [National treatment].

8. A reservation taken at the level of the Union applies to a measure of the Union, to a measure of a Member State at the central level or to a measure of a government within a Member State, unless the reservation excludes a Member State. A reservation taken by a Member State applies to a measure of a government at the central, regional or local level within that Member State. For the purposes of the reservations of Belgium, the central level of government covers the federal government and the governments of the regions and the communities as each of them holds equipollent legislative powers. For the purposes of the reservations of the Union and its Member States, a regional level of government in Finland means the Åland Islands. A reservation taken at the level of the United Kingdom applies to a measure of the central government, a regional government or a local government.

9. The list of reservations below does not include measures relating to qualification requirements and procedures, technical standards and licensing requirements and procedures where they do not constitute a limitation within the meaning of Article SERVIN.2.2 [Market access – Investment liberalisation], Article SERVIN.2.3 [National treatment – Investment liberalisation], Article SERVIN.3.2 [Market access – Cross-border trade in services], Article SERVIN.3.3 [Local presence – Cross-border trade in services], Article SERVIN.3.4 [National treatment – Cross-border

trade in services] or Article SERVIN 5.49 [Obligations – Legal services]. These measures may include, in particular, the need to obtain a licence, to satisfy universal service obligations, to have recognised qualifications in regulated sectors, to pass specific examinations, including language examinations, to fulfil a membership requirement of a particular profession, such as membership in a professional organisation, to have a local agent for service, or to maintain a local address, or any other non-discriminatory requirements that certain activities may not be carried out in protected zones or areas. While not listed, such measures continue to apply.

10. For greater certainty, for the Union, the obligation to grant national treatment does not entail the requirement to extend to natural or legal persons of the United Kingdom the treatment granted in a Member State, pursuant to the Treaty on the Functioning of the European Union, or any measure adopted pursuant to that Treaty, including their implementation in the Member States, to:

- (i) natural persons or residents of another Member State; or
- (ii) legal persons constituted or organised under the law of another Member State or of the Union and having their registered office, central administration or principal place of business in the Union.

11. Treatment granted to legal persons established by investors of a Party in accordance with the law of the other Party (including, in the case of the Union, the law of a Member State) and having their registered office, central administration or principal place of business within that other Party, is without prejudice to any condition or obligation, consistent with Chapter 2 [Investment liberalisation] of Title II [Services and investment] of Heading One [Trade] of Part Two [Trade, transport and fisheries], which may have been imposed on such legal person when it was established in that other Party, and which shall continue to apply.

12. The schedules apply only to the territories of the United Kingdom and the Union in accordance with Article FINPROV.1[Territorial scope] and Article OTH.9(2) [Geographical scope] and are only relevant in the context of trade relations between the Union and its Member States with the United Kingdom. They do not affect the rights and obligations of the Member States under Union law.

13. For greater certainty, non-discriminatory measures do not constitute a market access limitation within the meaning of Articles SERVIN. 2.2 [Market access – Investment liberalisation], SERVIN.3.2 [Market access – Cross-border trade in services], or Article SERVIN.5.49 [Obligations – Legal services] for any measure:

- (a) requiring the separation of the ownership of infrastructure from the ownership of the goods or services provided through that infrastructure to ensure fair competition, for example in the fields of energy, transportation and telecommunications;
- (b) restricting the concentration of ownership to ensure fair competition;
- (c) seeking to ensure the conservation and protection of natural resources and the environment, including a limitation on the availability, number and scope of concessions granted, and the imposition of a moratorium or ban;
- (d) limiting the number of authorisations granted because of technical or physical constraints, for example telecommunications spectra and frequencies; or

- (e) requiring that a certain percentage of the shareholders, owners, partners, or directors of an enterprise be qualified or practice a certain profession such as lawyers or accountants.

14. With respect to financial services: Unlike foreign subsidiaries, branches established directly in a Member State by a non-European Union financial institution are not, with certain limited exceptions, subject to prudential regulations harmonised at Union level which enable such subsidiaries to benefit from enhanced facilities to set up new establishments and to provide cross-border services throughout the Union. Therefore, such branches receive an authorisation to operate in the territory of a Member State under conditions equivalent to those applied to domestic financial institutions of that Member State, and may be required to satisfy a number of specific prudential requirements such as, in the case of banking and securities, separate capitalisation and other solvency requirements and reporting and publication of accounts requirements or, in the case of insurance, specific guarantee and deposit requirements, a separate capitalisation, and the localisation in the Member State concerned of the assets representing the technical reserves and at least one third of the solvency margin.

The following abbreviations are used in the list of reservations below:

UK United Kingdom

EU European Union, including all its Member States

AT Austria

IE Ireland

BE Belgium

IT Italy

BG Bulgaria

LT Lithuania

CY Cyprus

LU Luxembourg

CZ Czech Republic

LV Latvia

DE Germany

MT Malta

DK Denmark

NL The Netherlands

EE Estonia

PL Poland

EL Greece

PT Portugal

ES Spain

RO Romania

FI Finland

SE Sweden

FR France

SI Slovenia

HR Croatia

SK Slovak Republic

HU Hungary

## **Schedule of the Union**

**Reservation No. 1 - All sectors**

**Reservation No. 2 - Professional services (except health-related professions)**

**Reservation No. 3 - Professional services (health related and retail of pharmaceuticals)**

**Reservation No. 4 - Research and development services**

**Reservation No. 5 - Real estate services**

**Reservation No. 6 - Business services**

**Reservation No. 7 - Communication services**

**Reservation No. 8 - Construction Services**

**Reservation No. 9 - Distribution services**

**Reservation No. 10 - Education services**

**Reservation No. 11 - Environmental services**

**Reservation No. 12 – Financial Services**

**Reservation No. 13 - Health services and social services**

**Reservation No. 14 - Tourism and travel related services**

**Reservation No. 15 - Recreational, cultural and sporting services**

**Reservation No. 16 - Transport services and services auxiliary to transport services**

**Reservation No. 17 - Energy related activities**

**Reservation No. 18 - Agriculture, fishing and manufacturing**

## Reservation No. 1 - All sectors

**Sector:** *All sectors*

**Type of reservation:** Market access  
National treatment  
Most-favoured-nation treatment  
Performance requirements  
Senior management and boards of directors  
Obligations for Legal services

**Chapter / Section:** Investment liberalisation; Cross-border trade in services and Regulatory framework for Legal services

**Level of government:** EU/ Member State (unless otherwise specified)

### **Description:**

#### **(a) Type of establishment**

With respect to Investment liberalisation – National treatment and Regulatory framework for Legal services – Obligations:

The **EU**: Treatment granted pursuant to the Treaty on the Functioning of the European Union to legal persons formed in accordance with the law of the Union or of a Member State and having their registered office, central administration or principal place of business within the Union, including those established in the Union by investors of the United Kingdom, is not accorded to legal persons established outside the Union, nor to branches or representative offices of such legal persons, including to branches or representative offices of legal persons of the United Kingdom.

Treatment less favourable may be accorded to legal persons formed in accordance with the law of the European Union or of a Member State which have only their registered office in the Union, unless it can be shown that they possess an effective and continuous link with the economy of one of the Member States.

### **Measures:**

**EU:** *Treaty on the Functioning of the European Union.*

With respect to Investment liberalisation – Market access, National treatment, Senior management and boards of directors:

*This reservation applies only to health, social or education services:*

The **EU** (applies also to the regional level of government): Any Member State, when selling or disposing of its equity interests in, or the assets of, an existing state enterprise or an existing governmental entity providing health, social or education services (CPC 93, 92), may prohibit or impose limitations on the ownership of such interests or assets, and/or restrict the ability of owners of such interests and assets to control any resulting enterprise, with respect to investors of the United Kingdom or their enterprises. With respect to such a sale or other disposition, any Member



State may adopt or maintain any measure relating to the nationality of senior management or members of the boards of directors, as well as any measure limiting the number of suppliers.

For the purposes of this reservation:

(i) any measure maintained or adopted after the date of entry into force of this Agreement that, at the time of the sale or other disposition, prohibits or imposes limitations on the ownership of equity interests or assets or imposes nationality requirements or imposes limitations on the numbers of suppliers as described in this reservation shall be deemed to be an existing measure; and

(ii) "state enterprise" means an enterprise owned or controlled through ownership interests by any Member State and includes an enterprise established after the date of entry into force of this Agreement solely for the purposes of selling or disposing of equity interests in, or the assets of, an existing state enterprise or governmental entity.

**Measures:**

**EU:** *As set out in the description element as indicated above.*

With respect to Investment liberalisation – National Treatment and Regulatory framework for Legal services – Obligations

In **AT:** For the operation of a branch, non-European Economic Area (non-EEA) corporations must appoint at least one person responsible for its representation who is resident in Austria.

Executives (managing directors, natural persons) responsible for the observance of the Austrian Trade Act (Gewerbeordnung) must be domiciled in Austria.

In **BG:** Foreign legal persons, unless established under the legislation of a Member State of the European Economic Area (EEA), may conduct business and pursue activities if established in the Republic of Bulgaria in the form of a company registered in the Commercial Register. Establishment of branches is subject to authorisation.

Representative offices of foreign enterprises are to be registered with Bulgarian Chamber of Commerce and Industry and may not engage in economic activity but are only entitled to advertise their owner and act as representatives or agents.

In **EE:** If the residence of at least half of the members of the management board of a private limited company, a public limited company or a branch is not in Estonia, in another Member State of the EEA or in the Swiss Confederation, the private limited company, the public limited company or the foreign company shall appoint a point of contact whose Estonian address can be used for the delivery of the procedural documents of the undertaking and the declarations of intent addressed to the undertaking (i.e. the branch of a foreign company).

With respect to Investment liberalisation – National treatment; Cross-border trade in services – Market access and Regulatory framework for Legal services – Obligations:

In **FI:** At least one of the partners in a general partnership or of general partners in a limited partnership needs to have residency in the EEA or, if the partner is a legal person, be domiciled (no branches allowed) in the EEA. Exemptions may be granted by the registration authority.

To carry on trade as a private entrepreneur, residency in the EEA is required.

If a foreign organisation from a country outside the EEA intends to carry on a business or trade by establishing a branch in Finland, a trade permit is required.

Residency in the EEA is required for at least one of the ordinary and one of the deputy members of the board of directors and for the managing director. Company exemptions may be granted by the registration authority.

In **SE**: A foreign company, which has not established a legal entity in Sweden or is conducting its business through a commercial agent, shall conduct its commercial operations through a branch, registered in Sweden, with independent management and separate accounts. The managing director and the vice-managing director, if appointed, of the branch, must reside in the EEA. A natural person not resident in the EEA, who conducts commercial operations in Sweden, shall appoint and register a resident representative responsible for the operations in Sweden. Separate accounts shall be kept for the operations in Sweden. The competent authority may in individual cases grant exemptions from the branch and residency requirements. Building projects with duration of less than a year, conducted by a company located or a natural person residing outside the EEA, are exempted from the requirements of establishing a branch or appointing a resident representative.

For limited liability companies and co-operative economic associations, at least 50 per cent of the members of the board of directors, at least 50 per cent of the deputy board members, the managing director, the vice-managing director, and at least one of the persons authorised to sign for the company, if any, must reside within the EEA. The competent authority may grant exemptions from this requirement. If none of the company's or society's representatives reside in Sweden, the board must appoint and register a person resident in Sweden, who has been authorised to receive servings on behalf of the company or society.

Corresponding conditions prevail for establishment of all other types of legal entities.

In **SK**: A foreign natural person whose name is to be registered in the appropriate register (Commercial register, Entrepreneurial or other professional register) as a person authorised to act on behalf of an entrepreneur is required to submit a residence permit for Slovakia.

**Measures:**

**AT:** *Aktiengesetz, BGBl. Nr. 98/1965, § 254 (2);*

*GmbH-Gesetz, RGBL. Nr. 58/1906, § 107 (2); and Gewerbeordnung, BGBl. Nr. 194/1994, § 39 (2a).*

**BG:** *Commercial Law, Article 17a; and*

*Law for Encouragement of Investments, Article 24.*

**EE:** *Ärisedustik (Commercial Code) § 63<sup>1</sup> (1, 2 and 4).*

**FI:** *Laki elinkeinon harjoittamisen oikeudesta (Act on the Right to Carry on a Trade) (122/1919), s. 1;*

*Osuuskuntalaki (Co-Operatives Act) 1488/2001;*

*Osakeyhtiölaki (Limited Liabilities Company Act) (624/2006); and*

*Laki luottolaitostoiminnasta (Act on Credit Institutions) (121/2007).*

**SE:** *Lag om utländska filialer m.m (Foreign Branch Offices Act) (1992:160);*

*Aktiebolagslagen (Companies Act) (2005:551);*

*The Co-operative Economic Associations Act (2018:672); and Act on European Economic Interest Groupings (1994:1927).*

**SK:** *Act 513/1991 on Commercial Code (Article 21); Act 455/1991 on Trade Licensing; and*

*Act no 404/2011 on Residence of Aliens (Articles 22 and 32).*

With respect to Investment liberalisation – Market Access, National Treatment, Performance requirements and Regulatory framework for Legal services – Obligations:

In **BG:** Established enterprises may employ third country nationals only for positions for which there is no requirement for Bulgarian nationality. The total number of third country nationals employed by an established enterprise over a period of the preceding 12 months must not exceed 20 percent (35 percent for small and medium-sized enterprises) of the average number of Bulgarian nationals, nationals of other Member States, of states parties to the Agreement on the EEA or of the Swiss Confederation hired on an employment contract. In addition, the employer must demonstrate that there is no suitable Bulgarian, EU, EEA or Swiss worker for the respective position by conducting a labour market test before employing a third country national.

For highly qualified, seasonal and posted workers, as well as for intra-corporate transferees, researchers and students there is no limitation on the number of third country nationals working for a single enterprise. For the employment of third country nationals in these categories, no labour market test is required.

**Measures:**

**BG:** *Labour Migration and Labour Mobility Act.*

With respect to Investment liberalisation – Market access, National treatment:

In **PL:** The scope of operations of a representative office may only encompass advertising and promotion of the foreign parent company represented by the office. For all sectors except legal services, establishment by non-European Union investors and their enterprises may only be in the form of a limited partnership, limited joint-stock partnership, limited liability company, and joint-stock company, while domestic investors and enterprises have access also to the forms of non-commercial partnership companies (general partnership and unlimited liability partnership).

**Measures:**

**PL:** *Act of 6 March 2018 on rules regarding economic activity of foreign entrepreneurs and other foreign persons in the territory of the Republic of Poland.*

**(b) Acquisition of real estate**

With respect to Investment liberalisation – National treatment:

In **AT** (applies to the regional level of government): The acquisition, purchase and rental or leasing of real estate by non-European Union natural persons and enterprises requires authorisation by the competent regional authorities (Länder). Authorisation will only be granted if the acquisition is considered to be in the public (in particular economic, social and cultural) interest.

In **CY**: Cypriots or persons of Cypriot origin, as well as nationals of a Member State, are allowed to acquire any property in Cyprus without restrictions. A foreigner shall not acquire, otherwise than *mortis causa*, any immovable property without obtaining a permit from the Council of Ministers. For foreigners, where the acquisition of immovable property exceeds the extent necessary for the erection of a premises for a house or professional roof, or otherwise exceeds the extent of two donums (2,676 square meter), any permit granted by the Council of Ministers shall be subject to such terms, limitations, conditions and criteria which are set by Regulations made by the Council of Ministers and approved by the House of Representatives. A foreigner is any person who is not a citizen of the Republic of Cyprus, including a foreign controlled company. The term does not include foreigners of Cypriot origin or non-Cypriot spouses of citizens of the Republic of Cyprus.

In **CZ**: Specific rules apply to agricultural land under state ownership. State agricultural land can be acquired only by Czech nationals, nationals of another Member State, or states parties to the Agreement on the EEA or the Swiss Confederation. Legal persons can acquire state agriculture land from the state only if they are agricultural entrepreneurs in the Czech Republic or persons with similar status in other Member State of the European Union, or states parties to the Agreement on the EEA or the Swiss Confederation.

In **DK**: Natural persons who are not resident in Denmark, and who have not previously been resident in Denmark for a total period of five years, must in accordance with the Danish Acquisition Act obtain permission from the Ministry of Justice to acquire title to real property in Denmark. This also applies for legal persons that are not registered in Denmark. For natural persons, acquisition of real property will be permitted if the applicant is going to use the real property as his or her primary residence.

For legal persons that are not registered in Denmark, acquisition of real property will in general be permitted, if the acquisition is a prerequisite for the business activities of the purchaser. Permission is also required if the applicant is going to use the real property as a secondary dwelling. Such permission will only be granted if the applicant through an overall and concrete assessment is regarded to have particular strong ties to Denmark.

Permission under the Acquisition Act is only granted for the acquisition of a specific real property. The acquisition of agricultural land by natural or legal persons is in addition governed by the Danish Agricultural Holdings Act, which imposes restrictions on all persons, Danish or foreign, when acquiring agricultural property. Accordingly, any natural or legal person, who wishes to acquire agricultural real property, must fulfil the requirements in this Act. This generally means a limited residence requirement on the agricultural holding applies. The residence requirement is not personal. Legal entities must be of the types listed in §20 and §21 of the act and must be registered in the Union (or EEA).

In **EE**: A legal person from an OECD Member State has the right to acquire an immovable which contains:

- i. less than ten hectares of agricultural land, forest land or agricultural and forest land in total without restrictions.

- ii. ten hectares or more of agricultural land if the legal person has been engaged, for three years immediately preceding the year of making the transaction of acquisition of the immovable, in production of agricultural products listed in Annex I to the Treaty on the Functioning of the European Union, except fishery products and cotton (hereinafter agricultural product).
- iii. ten hectares or more of forest land if the legal person has been engaged, for three years immediately preceding the year of making the transaction of acquisition of the immovable, in forest management within the meaning of the Forest Act (hereinafter forest management) or production of agricultural products.
- iv. less than ten hectares of agricultural land and less than ten hectares of forest land, but ten hectares or more of agricultural and forest land in total, if the legal person has been engaged, for three years immediately preceding the year of making the transaction of acquisition of the immovable, in production of agricultural products or forest management.

If a legal person does not meet the requirements provided for in (ii)–(iv), the legal person may acquire an immovable which contains ten hectares or more of agricultural land, forest land or agricultural and forest land in total only with the authorisation of the council of the local government of the location of the immovable to be acquired.

Restrictions on acquiring immovable property apply in certain geographical areas for non-EEA nationals.

In **EL**: Real estate acquisition or tenancy in the border regions is prohibited to natural or legal persons whose nationality or base is outside the Member States and the European Free Trade Association. The ban may be lifted with a discretionary decision taken by a committee of the appropriate Decentralized Administration (or the Minister of National Defense in case the properties to be exploited belong to the Fund for the Exploitation of Private Public Property).

In **HR**: Foreign companies are only allowed to acquire real estate for the supply of services if they are established and incorporated in Croatia as legal persons. Acquisition of real estate necessary for the supply of services by branches requires the approval of the Ministry of Justice. Agricultural land cannot be acquired by foreigners.

In **MT**: Non-nationals of a Member State may not acquire immovable property for commercial purposes. Companies with 25 per cent (or more) of non-European Union shareholding must obtain an authorisation from the competent authority (Minister responsible for Finance) to buy immovable property for commercial or business purposes. The competent authority will determine whether the proposed acquisition represents a net benefit to the Maltese economy.

In **PL**: The acquisition of real estate, direct and indirect, by foreigners requires a permit. A permit is issued through an administrative decision by a minister competent in internal affairs, with the consent of the Minister of National Defence, and in the case of agricultural real estate, also with the consent of the Minister of Agriculture and Rural Development.

**Measures:**

**AT:** *Burgenländisches Grundverkehrsgesetz, LGBL. Nr. 25/2007;*

*Kärntner Grundverkehrsgesetz, LGBL. Nr. 9/2004;*

*NÖ- Grundverkehrsgesetz, LGBL. 6800;*

*OÖ- Grundverkehrsgesetz, LGBL. Nr. 88/1994;*

*Salzburger Grundverkehrsgesetz, LGBL. Nr. 9/2002;*

*Steiermärkisches Grundverkehrsgesetz, LGBL. Nr. 134/1993;*

*Tiroler Grundverkehrsgesetz, LGBL. Nr. 61/1996; Voralberger Grundverkehrsgesetz, LGBL. Nr. 42/2004; and*

*Wiener Ausländergrundverkehrsgesetz, LGBL. Nr. 11/1998.*

**CY:** *Immovable Property Acquisition (Aliens) Law (Chapter 109), as amended.*

**CZ:** *Act No. 503/2012, Coll. on State Land Office as amended.*

**DK:** *Danish Act on Acquisition of Real Property (Consolidation Act No. 265 of 21 March 2014 on Acquisition of Real Property);*

*Acquisition Executive Order (Executive Order No. 764 of 18 September 1995); and The Agricultural Holdings Act (Consolidation Act No. 27 of 4 January 2017).*

**EE:** *Kinnisasja omandamise kitsendamise seadus (Restrictions on Acquisition of Immovables Act) Chapter 2 § 4, Chapter 3§ 10, 2017.*

**EL:** *Law 1892/1990, as it stands today, in combination, as far as the application is concerned, with the ministerial decision F.110/3/330340/S.120/7-4-14 of the Minister of National Defense and the Minister of Citizen Protection.*

**HR:** *Ownership and other Proprietary Rights Act (OG 91/96, 68/98, 137/99, 22/00, 73/00, 129/00, 114/01, 79/06, 141/06, 146/08, 38/09, 143/12, 152/14), Articles 354 to 358.b; Agricultural Land Act (OG 20/18, 115/18, 98/19) Article 2; General Administrative Procedure Act.*

**MT:** *Immovable Property (Acquisition by Non-Residents) Act (Cap. 246); and Protocol No 6 of the EU Accession Treaty on the acquisition of secondary residences in Malta.*

**PL:** *Law of 24th March 1920 on the Acquisition of Real Estate by Foreigners (Journal of Laws of 2016, item 1061 as amended).*

With respect to Investment liberalisation – Market access, National treatment:

In **HU:** The purchase of real estate by non-residents is subject to obtaining authorisation from the appropriate administrative authority responsible for the geographical location of the property.

**Measures:**

**HU:** *Government Decree No. 251/2014 (X. 2.) on the Acquisition by Foreign Nationals of*

*Real Estate other than Land Used for Agricultural or Forestry Purposes; and Act LXXVIII of 1993 (Paragraph 1/A).*

With respect to Investment liberalisation – Market access, National treatment, Most-favoured nation treatment:

In **LV**: Acquisition of urban land by nationals of the United Kingdom is permitted through legal persons registered in Latvia or other Member States:

- (i) if more than 50 per cent of their equity capital is owned by nationals of Member States, the Latvian Government or a municipality, separately or in total;
- (ii) if more than 50 per cent of their equity capital is owned by natural persons and companies of third country with whom Latvia has concluded bilateral agreements on promotion and reciprocal protection of investments and which have been approved by the Latvian Parliament before 31 December 1996;
- (iii) if more than 50 per cent of their equity capital is possessed by natural persons and companies of third country with whom Latvia has concluded bilateral agreements on promotion and reciprocal protection of investments after 31 December 1996, if in those agreements the rights of Latvian natural persons and companies on acquisition of land in the respective third country have been determined;
- (iv) if more than 50 per cent of their equity capital is possessed jointly by persons referred to in points (i) to (iii); or
- (v) which are public joint stock companies, if their shares thereof are quoted in the stock exchange.

Where the United Kingdom allows Latvian nationals and enterprises to purchase urban real estate in their territories, Latvia will allow nationals and enterprises of the United Kingdom to purchase urban real estate in Latvia under the same conditions as Latvian nationals.

**Measures:**

*LV: Law on land reform in the cities of the Republic of Latvia, Section 20 and 21.*

With respect to Investment liberalisation - National treatment, Most-favoured-nation treatment:

In **DE**: Certain conditions of reciprocity may apply for the acquisition of real estate.

In **ES**: Foreign investment in activities directly relating to real estate investments for diplomatic missions by states that are not Member States requires an administrative authorisation from the Spanish Council of Ministers, unless there is a reciprocal liberalisation agreement in place.

In **RO**: Foreign nationals, stateless persons and legal persons (other than nationals and legal persons of a Member State of the EEA) may acquire property rights over lands, under the conditions regulated by international treaties, based on reciprocity. Foreign nationals, stateless persons and legal persons may not acquire the property right over lands under more favourable conditions than those applicable to natural or legal persons of the European Union.

**Measures:**

*DE: Einführungsgesetz zum Bürgerlichen Gesetzbuche (EGBGB; Introductory Law to the Civil Code).*

*ES: Royal Decree 664/1999 of 23 April 1999 relating to foreign investment.*

**RO:** *Law 17/2014 on some measures regulating the selling-buying agricultural land situated outside town and amending; and*

*Law No 268/2001 on the privatization of companies that own land in public ownership and private management of the state for agricultural and establishing the State Domains Agency, with subsequent amendments.*



## Reservation No. 2 - Professional services (except health-related professions)

<b>Sector – sub-sector:</b>	Professional services – legal services; patent agent, industrial property agent, intellectual property attorney; accounting and bookkeeping services; auditing services, taxation advisory services; architecture and urban planning services, engineering services and integrated engineering services
<b>Industry classification:</b>	CPC 861, 862, 863, 8671, 8672, 8673, 8674, part of 879
<b>Type of reservation:</b>	Market access National treatment Most-favoured-nation treatment Senior management and boards of directors Local presence Obligations for Legal services
<b>Chapter / Section:</b>	Investment liberalisation; Cross-border trade in services and Regulatory framework for Legal services
<b>Level of government:</b>	EU/ Member State (unless otherwise specified)

### Description:

#### **(a) Legal services (part of CPC 861)<sup>120</sup>**

---

<sup>120</sup> For the purposes of this reservation:

(a) "host-jurisdiction law" means the law of the specific Member State and European Union law;

"home-jurisdiction law" means the law of the United Kingdom;

(b) "international law" means public international law with the exception of European Union law, and includes law established by international treaties and conventions, as well as international customary law;

(c) "legal advisory services" includes provision of advice to and consultation with clients in matters, including transactions, relationships and disputes, involving the application or interpretation of law; participation with or on behalf of clients in negotiations and other dealings with third parties in such matters; and preparation of documents governed in whole or in part by law, and the verification of documents of any kind for purposes of and in accordance with the requirements of law;

(d) "legal representational services" includes preparation of documents intended to be submitted to administrative agencies, the courts or other duly constituted official tribunals; and appearance before administrative agencies, the courts or other duly constituted official tribunals;

(e) "Legal arbitration, conciliation and mediation services" means the preparation of documents to be submitted to, the preparation for and appearance before, an arbitrator, conciliator or mediator in any dispute involving the application and interpretation of law. It does not include arbitration, conciliation and mediation services in disputes not involving the application and interpretation of law, which fall under services incidental to management consulting. It also does not include acting as an arbitrator, conciliator or mediator. As a sub-

With respect to Investment liberalisation – Market access – and Regulatory framework for LegalsServices – Obligations

In **EU**: Specific non-discriminatory legal form requirements apply in each Member State.

*(i) Designated legal services supplied under the home professional title (part of CPC 861 – legal advisory, arbitration, conciliation and mediation services with regard to home-jurisdiction and international law governed by Section 7 [Legal services] of Chapter 5 [Regulatory framework] of Title II of Heading One [Trade] of Part Two [Trade, transport and fisheries])*

For greater certainty, consistent with the Headnotes, in particular paragraph 9, requirements to register with a Bar may include a requirement to have completed some training under the supervision of a licensed lawyer, or to have an office or a postal address within the jurisdiction of a specific Bar in order to be eligible to apply for membership in that Bar. Some Member States may impose the requirement of having the right to practise host-jurisdiction law on those natural persons holding certain positions within a law firm/company/enterprise or for shareholders.

With respect to Investment liberalisation – Market access, National treatment and Cross-border trade in services – National treatment, Market access and Regulatory framework for Legal services – Obligations:

In **AT**:

EEA or Swiss nationality as well as residency (commercial presence) is required for the practice of legal services in respect of host jurisdiction (Union and Member State) law, including representation before courts. Only lawyers of EEA or Swiss nationality are allowed to provide legal services through commercial presence. The practice of legal services in respect of public international law and home-jurisdiction law is only allowed on a cross-border basis.

Equity participation and shares in the operating result of any law firm by foreign lawyers (who must be fully qualified in their home-jurisdiction) is allowed up to 25 per cent; the rest must be held by fully qualified EEA or Swiss lawyers and only the latter may exercise decisive influence in the decision making of the law firm.

In **BE**: (with respect also to Most-favoured-nation treatment) Foreign lawyers may practise as legal consultants. Lawyers who are members of foreign (non-EU) Bars and want to establish in Belgium but do not meet the conditions for registration on the Tableau of fully qualified lawyers, on the EU-list or on the List of Trainee Lawyers, may request registration on the so-called "B-List". Only at the Brussels Bar there exists such a "B-List". A lawyer on the B-list is allowed to supply designated legal services.

In **BG**: (with respect also to Most-favoured-nation treatment): Permanent residency is required for legal mediation services. A mediator may be only a person who has been entered in the Uniform Register of Mediators with the Minister of Justice.

---

category, international legal arbitration, conciliation or mediation services refers to the same services when the dispute involves parties from two or more countries.

In Bulgaria, full national treatment on the establishment and operation of companies, as well as on the supply of services, may be extended only to companies established in, and citizens of, countries with whom bilateral agreements on mutual legal assistance have been or will be concluded.

In **CY**: EEA or Swiss nationality as well as residency (commercial presence) is required. Only advocates enrolled in the Bar may be partners or shareholders or members of the board of directors in a law company in Cyprus.

In **CZ**: For foreign lawyers residence (commercial presence) is required.

In **DE**: For foreign lawyers (with other than EEA and Swiss qualification) there may be restrictions for holding shares of a lawyers company which provides legal services in host-jurisdiction law.

In **DK**: Without prejudice to the EU reservation above, shares of a law firm can only be owned by advocates who actively practise law in the firm, its parent company or its subsidiary company, other employees in the firm, or another law firm registered in Denmark. Other employees in the firm may collectively only own less than 10 per cent of the shares and of the voting rights, and in order to be shareholders they must pass an exam on the rules of particular importance for the practice of law.

Only advocates who actively practise law in the firm, its parent company or its subsidiary company, other shareholders, and representatives of employees, may be members of the board. The majority of the members of the board must be advocates who actively practise law in the firm, its parent company or its subsidiary company. Only advocates who actively practise law in the firm, its parent company or its subsidiary company, and other shareholders having passed the exam mentioned above, may be a director of the law firm.

In **ES**: Professional address is required in order to provide designated legal services.

In **FR**, Residency or establishment in the EEA is required to practise on a permanent basis. Without prejudice to the EU reservation above: For all lawyers, company must take one of the following legal forms authorised under French law on a non-discriminatory basis: SCP (société civile professionnelle), SEL (société d'exercice libéral), SEP (société en participation), SARL (société à responsabilité limitée), SAS (société par actions simplifiée), SA (société anonyme), SPE (société pluriprofessionnelle d'exercice) and "association", under certain conditions. Shareholders, directors and partners may be subject to specific restrictions related to their professional activity.

In **HR**: Only a lawyer who has the Croatian title of lawyer can establish a law firm (UK firms can establish branches, which may not employ Croatian lawyers).

In **HU**: A cooperation contract concluded with a Hungarian attorney (ügyvéd) or law firm (ügyvédi iroda) is required. A foreign legal adviser cannot be a member of a Hungarian law firm. A foreign lawyer is not authorized for the preparation of documents to be submitted to, or act as the client's legal representative before an arbitrator, conciliator or mediator in any dispute.

In **PT** (with respect also to Most-favoured-nation treatment): Foreigners holding a diploma awarded by any Faculty of Law in Portugal, may register with the Portuguese Bar (Ordem dos Advogados), under the same terms as Portuguese nationals, if their respective country grants Portuguese nationals reciprocal treatment.

Other foreigners holding a Degree in Law which has been acknowledged by a Faculty of Law in Portugal may register as members of the Bar Association provided they undergo the required training and pass the final assessment and admission exam.

Legal consultation is allowed by jurists, provided they have their professional residence (“domiciliação”) in PT, pass an admission exam and are registered in the Bar.

In **RO**: A foreign lawyer may not make oral or written conclusions before the courts and other judicial bodies, except for international arbitration.

In **SE**: (with respect also to Most-favoured-nation treatment) Without prejudice to the EU reservation above: A member of the Swedish Bar Association may not be employed by anyone other than a Bar member or a company conducting the business of a Bar member. However, a Bar member may be employed by a foreign company conducting the business of an advocate, provided that the company in question is domiciled in a country within the Union, the EEA or the Swiss Confederation. Subject to an exemption from the Board of the Swedish Bar Association, a member of the Swedish Bar Association may also be employed by a non-European Union law firm.

Bar members conducting their practice in the form of a company or a partnership may not have any other objective and may not carry out any other business than the practice of an advocate. Collaboration with other advocate businesses is permitted, however, collaboration with foreign businesses requires permission by the Board of the Swedish Bar Association. Only a Bar member may directly or indirectly, or through a company, practise as an advocate, own shares in the company or be a partner. Only a member may be a member or deputy member of the Board or deputy managing director, or an authorised signatory or secretary of the company or the partnership.

In **SI**: (with respect also to Most-favoured-nation treatment) A foreign lawyer who has the right to practise law in a foreign country may supply legal services or practise law under the conditions laid down in Article 34a of the Attorneys Act, provided the condition of actual reciprocity is fulfilled. Without prejudice to the EU reservation on non-discriminatory legal form requirements, commercial presence for appointed attorneys by the Slovene Bar Association is restricted to sole proprietorship, law firm with limited liability (partnership) or to a law firm with unlimited liability (partnership) only. The activities of a law firm shall be restricted to the practice of law. Only attorneys may be partners in a law firm.

In **SK**: For non-EU lawyers actual reciprocity is required.

**(ii) Other legal services (host-jurisdiction law including legal advisory, arbitration, conciliation and mediation services and legal representational services).**

For greater certainty, consistent with the Headnotes, in particular paragraph 9, requirements to register with a Bar may include a requirement to have obtained a law degree in the host jurisdiction or its equivalent, or to have completed some training under the supervision of a licensed lawyer, or to have an office or a postal address within the jurisdiction of a specific Bar in order to be eligible to apply for membership in that Bar.

With respect to Investment liberalisation – Market access, National treatment and Cross-border trade in services – National treatment, Local presence:

In **EU**: Representation of natural or legal persons before the European Union Intellectual Property Office (EUIPO) may only be undertaken by a legal practitioner qualified in one of the Member States of the EEA and having their place of business within the EEA, to the extent that they are entitled, within the said Member State, to act as a representative in trade mark matters or in industrial property matters and by professional representatives whose names appear on the list maintained for this purpose by the EUIPO. (Part of CPC 861)

In **AT**: EEA or Swiss nationality as well as residency (commercial presence) is required for the practice of legal services in respect of host jurisdiction (Union and Member State) law, including representation before courts. Only lawyers of EEA or Swiss nationality are allowed to provide legal services through commercial presence. The practice of legal services in respect of public international law and home-jurisdiction law is only allowed on a cross-border basis.

Equity participation and shares in the operating result of any law firm by foreign lawyers (who must be fully qualified in their home-jurisdiction) is allowed up to 25 per cent; the rest must be held by fully qualified EEA or Swiss lawyers and only the latter may exercise decisive influence in the decision making of the law firm.

In **BE**: (*with respect also to Most-favoured-nation treatment*) Residency is required for full admission to the Bar, including for representation before courts. The residency requirement for a foreign lawyer to obtain full admission to the Bar is at least six years from the date of application for registration, three years under certain conditions. Requirement to have a certificate issued by the Belgian Minister of Foreign Affairs under which the national law or international convention allows reciprocity (reciprocity condition).

Foreign lawyers may practise as legal consultants. Lawyers who are members of foreign (non-EU) Bars and want to establish in Belgium but do not meet the conditions for registration on the Tableau of fully qualified lawyers, on the EU-list or on the List of Trainee Lawyers, may request registration on the so-called "B-List". Only at the Brussels Bar there exists such a "B-List". A lawyer on the B-list is allowed to give advice. Representation before "the Cour de Cassation" is subject to nomination on a specific list.

In **BG**: (*with respect also to Most-favoured-nation treatment*) Reserved to nationals of a Member State, of another State which is a party to the Agreement on the EEA, or of the Swiss Confederation who has been granted authorisation to pursue the profession of lawyer according to the legislation of any of the aforementioned countries. A foreign national (except for the above mentioned) who has been authorised to pursue the profession of lawyer in accordance with the legislation of his or her own country, may appeal before judicial bodies of the Republic of Bulgaria as defence-counsel or mandatary of a national of his or her own country, acting on a specific case, together with a Bulgarian attorney-at-law, in cases where this has been envisaged in an agreement between the Bulgarian and the respective foreign state, or on the basis of mutuality, making a preliminary request to this effect to the Chairperson of the Supreme Bar Council. Countries, in respect of which mutuality exists, shall be designated by the Minister of Justice, upon request of the Chairperson of the Supreme Bar Council. In order to provide legal mediation services, a foreign national must have a permit for long-term or permanent residence in the Republic of Bulgaria and has been entered in the Uniform Register of Mediators with the Minister of Justice

In **CY**: EEA or Swiss nationality as well as residency (commercial presence) is required. Only advocates enrolled in the Bar may be partners or shareholders or members of the board of directors in a law company in Cyprus.

In **CZ**: For foreign lawyers full admission to the Czech Bar Association and residence (commercial presence) is required.

In **DE**: Only lawyers with EEA or Swiss qualification may be admitted to the Bar and are thus entitled to provide legal services. Commercial presence is required in order to obtain full admission to the Bar. Exemptions may be granted by the competent bar association. For foreign lawyers (with other

than EEA and Swiss qualification) there may be restrictions for holding shares of a lawyers company which provides legal services in domestic law.

In **DK**: Legal services provided under the title “advokat” (advocate) or any similar title, as well as representation before the courts, is reserved for advocates with a Danish license to practise. EU, EEA and Swiss advocates may practise under the title of their country of origin.

Without prejudice to the EU reservation on non-discriminatory legal form requirements, shares of a law firm can only be owned by advocates who actively practise law in the firm, its parent company or its subsidiary company, other employees in the firm, or another law firm registered in Denmark. Other employees in the firm may collectively only own less than 10 per cent of the shares and of the voting rights, and in order to be shareholders they must pass an exam on the rules of particular importance for the practice of law.

Only advocates who actively practise law in the firm, its parent company or its subsidiary company, other shareholders, and representatives of employees, may be members of the board. The majority of the members of the board must be advocates who actively practise law in the firm, its parent company or its subsidiary company. Only advocates who actively practise law in the firm, its parent company or its subsidiary company, and other shareholders having passed the exam mentioned above, may be a director of the law firm.

In **EE**: Residency (commercial presence) is required.

In **EL**: EEA or Swiss nationality and residency (commercial presence) is required

In **ES**: EEA or Swiss nationality is required. The competent authorities may grant nationality waivers.

In **FI**: EEA or Swiss residency and Bar membership is required for the use of the professional title of "advocate" (in Finnish "asianajaja" or in Swedish "advokat"). Legal services may also be provided by non-Bar members.

In **FR**: Without prejudice to the EU reservation on non-discriminatory legal form requirements, residency or establishment in the EEA is required for full admission to the Bar, necessary for the practice of legal services In a law firm, shareholding and voting rights may be subject to quantitative restrictions related to the professional activity of the partners. Representation before "the Cour de Cassation" and "Conseil d'Etat" is subject to quotas and reserved for FR and EU nationals.

For all lawyers, company must take one of the following legal forms authorised under French law on a non-discriminatory basis: SCP (société civile professionnelle), SEL (société d'exercice libéral), SEP (société en participation), SARL (société à responsabilité limitée), SAS (société par actions simplifiée), SA (société anonyme), SPE (société pluriprofessionnelle d'exercice) and “association”, under certain conditions. Residency or establishment in the EEA is required to practise on a permanent basis

In **HR**: European Union nationality is required.

In **HU**: EEA or Swiss nationality and residency (commercial presence) is required

In **LT**: (With respect also to Most-favoured-nation treatment) EEA or Swiss nationality and residency (commercial presence) is required.



Attorneys from foreign countries can practise as advocates in court only in accordance with international agreements, including specific provisions regarding representation before courts. Full admission to the Bar is required.

In **LU** (*with respect also to Most-favoured-nation treatment*): EEA or Swiss nationality and residency (commercial presence) is required. The Council of the Order may, on the basis of reciprocity, agree to waive the nationality requirement for a foreign national.

In **LV** (*with respect also to Most-favoured-nation treatment*): EEA or Swiss nationality is required. Attorneys from foreign countries can practise as advocates in court only in accordance with bilateral agreements on mutual legal assistance.

For European Union or foreign advocates, special requirements exist. For example, participation in court proceedings in criminal cases is only permitted in association with an advocate of the Latvian Collegium of Sworn Advocates.

In **MT**: EEA or Swiss nationality as well as residency (commercial presence) is required.

In **NL**: Only locally-licensed lawyers registered in the Dutch registry can use the title "advocate". Instead of using the full term "advocate", (non-registered) foreign lawyers are obliged to mention their home-jurisdiction professional organisation for the purposes of their activities in the Netherlands.

In **PT** (with respect also to Most-favoured-nation treatment): residency (commercial presence) is required. For representation before courts, full admission to the Bar is required. Foreigners holding a diploma awarded by any Faculty of Law in Portugal, may register with the Portuguese Bar (Ordem dos Advogados), under the same terms as Portuguese nationals, if their respective country grants Portuguese nationals reciprocal treatment.

Other foreigners holding a Degree in Law which has been acknowledged by a Faculty of Law in Portugal may register as members of the Bar Association provided they undergo the required training and pass the final assessment and admission exam. Only law firms where the shares belong exclusively to lawyers admitted to the Portuguese Bar can practise in Portugal.

In **RO**: A foreign lawyer may not make oral or written conclusions before the courts and other judicial bodies, except for international arbitration.

In **SE**: (with respect also to Most-favoured-nation treatment) EEA or Swiss residency is required for admission to the Bar and use of the title of "advokat". Exemptions may be granted by the board of the Swedish Bar Association. Admission to the Bar is not necessary for the practice of Swedish law.

Without prejudice to the EU reservation on non-discriminatory legal form requirements, a member of the Swedish Bar Association may not be employed by anyone other than a Bar member or a company conducting the business of a Bar member. However, a Bar member may be employed by a foreign company conducting the business of an advocate, provided that the company in question is domiciled in a country within the EEA or the Swiss Confederation. Subject to an exemption from the Board of the Swedish Bar Association, a member of the Swedish Bar Association may also be employed by a non-European Union law firm.

Bar members conducting their practice in the form of a company or a partnership may not have any other objective and may not carry out any other business than the practice of an advocate. Collaboration with other advocate businesses is permitted, however, collaboration with foreign

businesses requires permission by the Board of the Swedish Bar Association. Only a Bar member may directly or indirectly, or through a company, practise as an advocate, own shares in the company or be a partner. Only a member may be a member or deputy member of the Board or deputy managing director, or an authorised signatory or secretary of the company or the partnership.

In **SI**: (with respect also to Most-favoured-nation treatment) Representing clients before the court against payment is conditioned by commercial presence in Republic of Slovenia. A foreign lawyer who has the right to practise home-jurisdiction law may perform legal services or practise law under the conditions laid down in Article 34a of the Attorneys Act, provided the condition of actual reciprocity is fulfilled.

Without prejudice to the EU reservation on non-discriminatory legal form requirements, commercial presence for appointed attorneys by the Slovene Bar Association is restricted to sole proprietorship, law firm with limited liability (partnership) or to a law firm with unlimited liability (partnership) only. The activities of a law firm shall be restricted to the practice of law. Only attorneys may be partners in a law firm.

In **SK**: (with respect also to Most-favoured-nation treatment) EEA nationality as well as residency (commercial presence) is required for the practice of legal services in respect of host-jurisdiction law, including representation before courts. For non-EU lawyers actual reciprocity is required.

**Measures:**

**EU**: Regulation (EU) 2017/1001 OF THE EUROPEAN PARLIAMENT AND OF THE COUNCIL of 14 June 2017 on the European Union trademark, Article 120; COUNCIL REGULATION (EC) No 6/2002 of 12 December 2001 on Community designs, Article 78 .

**AT**: Rechtsanwaltsordnung (Lawyers Act) - RAO, RGBl. Nr. 96/1868, Articles 1 and 21c.

**BE**: Belgian Judicial Code (Articles 428-508); Royal Decree of 24 August 1970.

**BG**: Attorney Law; Law for Mediation; and Law for the Notaries and Notarial Activity.

**CY**: Advocates Law (Chapter 2), as amended.

**CZ**: Act No. 85/1996 Coll., the Legal Profession Act.

**DE**: § 59e, § 59f, § 206 Bundesrechtsanwaltsordnung (BRAO; Federal Lawyers Act);

Gesetz über die Tätigkeit europäischer Rechtsanwälte in Deutschland (EuRAG); and § 10 Rechtsdienstleistungsgesetz (RDG).

**DK**: Retsplejeloven (Administration of Justice Act) chapters 12 and 13 (Consolidated Act No. 1284 of 14 November 2018).

**EE**: Advokatuuriseadus (Bar Association Act); Tsiviilkohtumenetluse seadustik (Code of Civil Procedure); halduskohtumenetluse seadustik (Code of Administrative Court Procedure); kriminaalmenetluse seadustik (Code of Criminal Procedure); and väärteomenetluse seadustik (Code of Misdemeanour Procedure).

**EL**: New Lawyers' Code n. 4194/2013.



**ES:** *Estatuto General de la Abogacía Española, aprobado por Real Decreto 658/2001, Article 13.1ª.*

**FI:** *Laki asianajajista (Advocates Act) (496/1958), ss. 1 and 3; and Oikeudenkäymiskaari (4/1734) (Code of Judicial Procedure).*

**FR:** *Loi 71-1130 du 31 décembre 1971, Loi 90- 1259 du 31 décembre 1990, décret 91-1197 du 27 novembre 1991, and Ordonnance du 10 septembre 1817 modifiée.*

**HR:** *Legal Profession Act (OG 9/94, 117/08, 75/09, 18/11).*

**HU:** *ACT LXXVIII of 2017 on the professional activities of Attorneys at Law.*

**LT:** *Law on the Bar of the Republic of Lithuania of 18 March 2004 No. IX-2066 as last amended on 12 December 2017 by law No XIII-571.*

**LU:** *Loi du 16 décembre 2011 modifiant la loi du 10 août 1991 sur la profession d'avocat.*

**LV:** *Criminal Procedure Law, s. 79; and Advocacy Law of the Republic of Latvia, s. 4.*

**MT:** *Code of Organisation and Civil Procedure (Cap. 12).*

**NL:** *Advocatenwet (Act on Advocates).*

**PT:** *Law 145/2015, 9 set., alterada p/ Lei 23/2020, 6 jul. (art.º 194 substituído p/ art.º 201.º; e art.º 203.º substituído p/ art.º 213.º).*

*Portuguese Bar Statute (Estatuto da Ordem dos Advogados) and Decree-Law 229/2004, Articles 5, 7 – 9;*

*Decree-law 88/2003, Articles 77 and 102;*

*Solicitadores Public Professional Association Statute (Estatuto da Câmara dos Solicitadores), as amended by Law 49/2004, mas alterada p/ Lei 154/2015, 14 set; by Law 14/2006 and by Decree-Law n.º 226/2008 alterado p/ Lei 41/2013, 26 jun;*

*Law 78/2001, Articles 31, 4 Alterada p/ Lei 54/2013, 31 jul.;*

*Regulation of family and labour mediation (Ordinance 282/2010), alterada p/ Portaria 283/2018, 19 out;*

*Law 21/2007 on criminal mediation, Article 12;*

*Law 22/2013, 26 fev., alterada p/ Lei 17/2017, 16 maio, alterada pelo Decreto-Lei 52/2019, 17 abril.*

**RO:** *Attorney Law;*

*Law for Mediation; and*

*Law for the Notaries and the Notarial Activity.*

**SE:** *Rättegångsbalken (The Swedish Code of Judicial Procedure) (1942:740); and Swedish Bar Association Code of Conduct adopted 29 August 2008.*

*SI: Zakon o odvetništvu (Neuradno prečiščeno besedilo-ZOdv-NPB2 Državnega Zbora RS z dne 21.5.2009 (Attorneys Act) unofficial consolidated text prepared by the Slovenian parliament from 21 5.2009).*

*SK: Act 586/2003 on Advocacy, Articles 2 and 12.*

With respect to Investment liberalisation - Market access, National treatment:

In **PL**: Foreign lawyers may establish only in the form of a registered partnership, a limited partnership or a limited joint-stock partnership.

**Measures:**

*PL: Act of 5 July 2002 on the provision by foreign lawyers of legal assistance in the Republic of Poland, Article 19.*

With respect to Cross-Border Trade in Services – Market access

In **IE, IT**: Residency (commercial presence) is required for the practice of legal services in respect of host-jurisdiction law, including representation before courts.

**Measures:**

*IE: Solicitors Acts 1954-2011.*

*IT: Royal Decree 1578/1933, Article 17 law on the legal profession.*

**(b) Patent agents, industrial property agents, intellectual property attorneys (part of CPC 879, 861, 8613)**

With respect to Investment liberalisation – Market access, National treatment and Cross-border trade in services – Local presence:

In **BG**, and **CY**: EEA or Swiss nationality is required for the practice of patent agency services. In **CY**, residency is required.

In **DE**: Only patent lawyers having German qualifications may be admitted to the Bar and are thus entitled to provide patent agent services in Germany in domestic law. Foreign patent lawyers can offer legal services in foreign law when they prove expert knowledge, registration is required for legal services in Germany. Foreign (other than EEA and Swiss qualification) patent lawyers may not establish a firm together with national patent lawyers.

Foreign (other than EEA and Swiss) patent lawyers may have their commercial presence only in the form of a Patentanwalts-GmbH or Patentanwalt-AG and may only acquire a minority share.

In **EE**: Estonian or EU nationality as well as permanent residency is required for the practice of patent agency services.

In **ES** and **PT**: EEA nationality is required for the practice of industrial property agent services.

In **FR**: To be registered on the industrial property agent services list, establishment or residency in the EEA is required. EEA nationality is required for natural persons. To represent a client in front of the national intellectual property office, establishment in the EEA is required. Provision only through

SCP (société civile professionnelle), SEL (société d'exercice libéral) or any other legal form, under certain conditions. Irrespective of the legal form, more than half of shares and voting rights must be held by EEA professionals. Law firms may be entitled to provide industrial property agent services (see reservation for legal services).

With respect to Cross-border trade in services – Local presence:

In **FI** and **HU**: EEA residency is required for the practice of patent agency services.

In **SI**: Residency in Slovenia is required for a holder/applicant of registered rights (patents, trademarks, design protection). Alternatively, a patent agent or a trademark and design agent registered in Slovenia is required for the main purpose of services of process, notification, etc.

**Measures:**

**BG**: Article 4 of the Ordinance for Representatives regarding Intellectual Property.

**CY**: Advocates Law (Chapter 2), as amended.

**DE**: Patentanwaltsordnung (PAO).

**EE**: Patendivoliniku seadus (Patent Agents Act) § 2, § 14.

**ES**: Ley 11/1986, de 20 de marzo, de Patentes de Invención y Modelos de utilidad, Articles 155-157.

**FI**: Tavaramerkkilaki (Trademarks Act) (7/1964);

Laki auktorisoiduista teollisoikeusasiamehistä (Act on Authorised Industrial Property Attorneys) (22/2014); and

Laki kasvinjalostajanoikeudesta (Plant Breeder's Right Act) 1279/2009; and Mallioikeuslaki (Registered Designs Act) 221/1971.

**FR**: Code de la propriété intellectuelle

**HU**: Act XXXII of 1995 on Patent Attorneys.

**PT**: Decree-Law 15/95, as modified by Law 17/2010, by Portaria 1200/2010, Article 5, and by Portaria 239/2013; and Law 9/2009.

**SI**: Zakon o industrijski lastnini (Industrial Property Act), Uradni list RS, št. 51/06 – uradno prečiščeno besedilo in 100/13 (Official Gazette of the Republic of Slovenia, No. 51/06 – official consolidated text and 100/13).

With respect to Investment liberalisation – National treatment and Cross-border trade in services – National Treatment, Local presence:

In **IE**: For establishment, at least one of the directors, partners, managers or employees of a company to be registered as a patent or intellectual property attorney in Ireland. Cross-border basis requires EEA nationality and commercial presence, principal place of business in an EEA Member State, qualification under the law of an EEA Member State.

**Measures:**

**IE:** Section 85 and 86 of the Trade Marks Act 1996, as amended;

Rule 51, Rule 51A and Rule 51B of the Trade Marks Rules 1996, as amended; Section 106 and 107 of the Patent Act 1992, as amended; and Register of Patent Agent Rules S.I. 580 of 2015.

**(c) Accounting and bookkeeping services (CPC 8621 other than auditing services, 86213, 86219, 86220)**

With respect to Investment liberalisation – Market access, National treatment and Cross-border trade in services – Local presence:

In **AT:** The capital interests and voting rights of foreign accountants, bookkeepers, qualified according to the law of their home country, in an Austrian enterprise may not exceed 25 per cent. The service supplier must have an office or professional seat in the EEA (CPC 862).

In **FR:** Establishment or residency is required. Provision through any company form except SNC (Société en nom collectif) and SCS (Société en commandite simple). Specific conditions apply to SEL (sociétés d'exercice libéral), AGC (Association de gestion et comptabilité) and SPE (Société pluri-professionnelle d'exercice). (CPC 86213, 86219, 86220).

In **IT:** Residence or business domicile is required for enrolment in the professional register, which is necessary for the provision of accounting and bookkeeping services (CPC 86213, 86219, 86220).

In **PT:** (with respect also to Most-favoured-nation treatment): Residence or business domicile is required for enrolment in the professional register by the Chamber of Certified Accountants (Ordem dos Contabilistas Certificados), which is necessary for the provision of accounting services, provided that there is reciprocal treatment for Portuguese nationals.

**Measures:**

**AT:** *Wirtschaftstreuhandberufsgesetz (Public Accountant and Auditing Profession Act, BGBl.*

*I Nr. 58/1999), § 12, § 65, § 67, § 68 (1) 4; and*

*Bilanzbuchhaltungsgesetz (BibuG), BGBl. I Nr. 191/2013, §§ 7, 11, 28.*

**FR:** *Ordonnance 45-2138 du 19 septembre 1945.*

**IT:** *Legislative Decree 139/2005; and Law 248/2006.*

**PT:** *Decree-Law n.º452/99, changed by Law n.º 139/2015, september 7th.*

With respect to Investment liberalisation – Market access and Cross-border trade in services – Market access:

In **CY:** Access is restricted to natural persons. Authorisation is required, subject to an economic needs test. Main criteria: the employment situation in the sub-sector. Professional associations (partnerships) between natural persons are permitted.

**Measures:**

**CY:** *Auditors Law of 2017 (Law 53(I)/2017).*

With respect to Cross-border trade in services – Local presence:

In **SI**: Establishment in the European Union is required in order to provide accounting and bookkeeping services (CPC 86213, 86219, 86220).

**Measures:**

**SI**: Act on services in the internal market, Official Gazette RS No 21/10.

**(d) Auditing services (CPC – 86211, 86212 other than accounting and bookkeeping services)**

With respect to Investment liberalisation – National treatment, Most-favoured nation treatment and Cross-border trade in services – National treatment, Most-favoured nation treatment:

In **EU**: Supply of statutory auditing services requires approval by the competent authorities of a Member State that may recognise the equivalence of the qualifications of an auditor who is a national of the United Kingdom or of any third country subject to reciprocity (CPC 8621).

**Measures:**

**EU**: Directive 2013/34/EU of the European Parliament and of the Council of 26 June 2013 on the annual financial statements, consolidated financial statements and related reports of certain types of undertakings, amending Directive 2006/43/EC of the European Parliament and of the Council and repealing Council Directives 78/660/EEC and 83/349/EEC; and Directive 2006/43/EC on statutory audits of annual accounts and consolidated accounts.

With respect to Investment liberalisation – Market access:

In **BG**: Non-discriminatory legal form requirements may apply.

**Measures:**

**BG**: Independent Financial Audit Act.

With respect to Investment liberalisation – Market access, National treatment, and Cross-border trade in services – Local presence:

In **AT**: The capital interests and voting rights of foreign auditors, qualified according to the law of their home country, in an Austrian enterprise may not exceed 25 per cent. The service supplier must have an office or professional seat in the EEA.

**Measures:**

**AT**: Wirtschaftstreuhandberufsgesetz (Public Accountant and Auditing Profession Act, BGBl.

I Nr. 58/1999), § 12, § 65, § 67, § 68 (1) 4.

With respect to Investment liberalisation – Market access and Cross-border trade in services – Local presence:

In **DK**: Provision of statutory auditing services requires Danish approval as an auditor. Approval requires residency in a Member State of the EEA. Voting rights in approved audit firms of auditors and audit firms not approved in accordance with regulation implementing the Directive 2006/43/EC

of the European Parliament and of the Council of 17 May 2006 on statutory audits of annual accounts and consolidated accounts based on Article 54(3)(g) of the Treaty on statutory audit must not exceed 10 per cent of the voting rights.

In **FR**: (with respect also to Most-favoured-nation treatment) For statutory audits: establishment or residency is required. British nationals may provide statutory auditing services in France, subject to reciprocity. Provision through any company form except those in which partners are considered to be traders ("commerçants"), such as SNC (Société en nom collectif) and SCS (Société en commandite simple).

In **PL**: Establishment in the European Union is required in order to provide auditing services.

Legal form requirements apply.

**Measures:**

**DK**: *Revisorloven (The Danish Act on Approved Auditors and Audit Firms), Act No. 1287 of 20/11/2018.*

**FR**: *Code de commerce*

**PL**: *Act of 11 May 2017 on statutory auditors, audit firms and public oversight - Journal of Laws of 2017, item 1089.*

With respect to Investment liberalisation – Market access, National treatment and Cross-border trade in services – Market access, National treatment:

In **CY**: Access is restricted to natural persons. Authorisation is required, subject to an economic needs test. Main criteria: the employment situation in the sub-sector. Professional associations (partnerships) between natural persons are permitted.

In **SK**: Only an enterprise in which at least 60 per cent of capital interests or voting rights are reserved to Slovak nationals or nationals of a Member State may be authorised to carry out audits in the Slovak Republic.

**Measures:**

**CY**: *Auditors Law of 2017 (Law 53(I)/2017).*

**SK**: *Act No. 423/2015 on Statutory audit.*

With respect to Investment liberalisation – Market access and Cross-border trade in services – National treatment, Local presence:

In **DE**: Auditing companies ("Wirtschaftsprüfungsgesellschaften") may only adopt legal forms admissible within the EEA. General partnerships and limited commercial partnerships may be recognised as 'Wirtschaftsprüfungsgesellschaften' if they are listed as trading partnerships in the commercial register on the basis of their fiduciary activities, Article 27 WPO. However, auditors from third countries registered in accordance with Article 134 WPO may carry out the statutory audit of annual fiscal statements or provide the consolidated financial statements of a company with its headquarters outside the Union, whose transferable securities are offered for trading in a regulated market.

**Measures:**

**DE:** *Handelsgesetzbuch (HGB; Code of Commercial Law);*

*Gesetz über eine Berufsordnung der Wirtschaftsprüfer (Wirtschaftsprüferordnung - WPO; Public Accountant Act).*

With respect to Investment liberalisation – National treatment and Cross-border trade in services – National treatment:

In **ES:** statutory auditors must be a national of a Member State. This reservation does not apply to the auditing of non-European Union companies listed in a Spanish regulated market.

**Measures:**

**ES:** *Ley 22/2015, de 20 de julio, de Auditoría de Cuentas (new Auditing Law: Law 22/2015 on Auditing services).*

With respect to Investment liberalisation – Market access, National treatment:

In **EE:** Legal form requirements apply. The majority of the votes represented by the shares of an audit firm shall belong to sworn auditors subject to supervision of a competent authority of a EEA Member State, who have acquired their qualification in an EEA Member state, or to audit firms. At least three-fourths of the persons representing an audit firm on the basis of law shall have acquired their qualifications in an EEA Member State.

**Measures:**

**EE:** *Auditors Activities Act (Audiitortegevuse seadus) § 76-77*

With respect to Investment liberalisation – National treatment, Most-favoured nation treatment and Cross-border trade in services – Local presence:

In **SI:** Commercial presence is required. A third country audit entity may hold shares or form partnerships in Slovenian audit company provided that, under the law of the country in which the third-country audit entity is incorporated, Slovenian audit companies may hold shares or form partnership in an audit entity in that country (reciprocity requirement).

**Measures:**

**SI:** *Auditing Act (ZRev-2), Official Gazette RS No 65/2008 (as last amended No 84/18); and Companies Act (ZGD-1), Official Gazette RS No 42/2006 (as last amended No 22/19 - ZPosS).*

With respect to Cross-border trade in services – Local presence:

In **BE:** An establishment in Belgium is required where the professional activity will take place and where acts, documents and correspondence relating to it will be maintained, and to have at least one administrator or manager of the establishment approved as auditor.

In **FI:** EEA residency required for at least one of the auditors of a Finnish Limited Liability company and of companies which are under the obligation to carry out an audit. An auditor must be a locally-licensed auditor or a locally-licensed audit firm.



In **HR**: Auditing services may be provided only by legal persons established in Croatia or by natural persons resident in Croatia.

In **IT**: Residency is required for the provision of auditing services by natural persons.

In **LT**: Establishment in the EEA is required for the provision of auditing services.

In **SE**: Only auditors approved in Sweden and auditing firms registered in Sweden may perform statutory auditing services. EEA residency is required. The titles of "approved auditor" and "authorised auditor" may only be used by auditors approved or authorised in Sweden. Auditors of co-operative economic associations and certain other enterprises who are not certified or approved accountants must be resident within the EEA, unless the Government, or a Government authority appointed by the Government, in a particular case allows otherwise.

**Measures:**

**BE**: *Law of July 22nd, 1953 creating an Institute of the Auditors of Firms and organising the public supervision of the occupation of auditor of firms, coordinated on April 30th, 2007.*

*(Public Accountant Act).*

**FI**: *Tilintarkastuslaki (Auditing Act) (459/2007), Sectoral laws requiring the use of locally licensed auditors.*

**HR**: *Audit Act (OG 146/05, 139/08, 144/12), Article 3.*

**IT**: *Legislative Decree 58/1998, Articles 155, 158 and 161;*

*Decree of the President of the Republic 99/1998; and Legislative Decree 39/2010, Article 2.*

**LT**: *Law on Audit of 15 June 1999 No. VIII -1227 (a new version of 3 July 2008 No. X1676).*

**SE**: *Revisorslagen (Auditors Act) (2001:883);*

*Revisionslag (Auditing Act) (1999:1079);*

*Aktiebolagslagen (Companies Act) (2005:551);*

*Lag om ekonomiska föreningar (The Co-operative Economic Associations Act) (2018:672); and*

*Others, regulating the requirements to make use of approved auditors.*

**(e) Taxation advisory services (CPC 863, not including legal advisory and legal representational services on tax matters, which are to be found legal services)**

With respect to Investment liberalisation – Market access, National treatment and Cross-border trade in services – Local presence:

In **AT**: The capital interests and voting rights of foreign tax advisors, qualified according to the law of their home country, in an Austrian enterprise may not exceed 25 per cent. The service supplier must have an office or professional seat in the EEA.

**Measures:**



**AT:** *Wirtschaftstreuhänderberufsgesetz (Public Accountant and Auditing Profession Act, BGBl.*

*I Nr. 58/1999), § 12, § 65, § 67, § 68 (1) 4.*

With respect to Investment liberalisation – Market access and Cross-border trade in services – Local presence:

In **FR:** Establishment or residency is required. Provision through any company form except SNC (Société en nom collectif) and SCS (Société en commandite simple). Specific conditions apply to SEL (sociétés d'exercice libéral), AGC (Association de gestion et comptabilité) and SPE (Société pluri-professionnelle d'exercice).

**Measures:**

**FR:** *Ordonnance 45-2138 du 19 septembre 1945.*

With respect to Investment liberalisation – National treatment and Cross-border trade in services – National treatment:

In **BG:** Nationality of a Member State is required for tax advisors.

**Measures:**

**BG:** *Accountancy Act;*

*Independent Financial Audit Act; Income Taxes on Natural Persons Act; and Corporate Income Tax Act.*

*With respect to Investment liberalisation – Market access, National treatment and Cross-border trade in services – Market access, National treatment:*

In **CY:** Access is restricted to natural persons. Authorisation is required, subject to an economic needs test. Main criteria: the employment situation in the sub-sector. Professional associations (partnerships) between natural persons are permitted.

**Measures:**

**CY:** *Auditors Law of 2017 (Law 53(I)/2017).*

With respect to Cross-border trade in services – Local presence:

In **HU:** EEA residency is required for the supply of taxation advisory services, insofar as they are being supplied by a natural person present in the territory of Hungary.

In **IT:** Residency is required.

**Measures:**

**HU:** *Act XCII of 2003 on the Rules of Taxation; and*

*Decree of the Ministry of Finance no. 26/2008 on the licensing and registration of taxation advisory activities.*

*IT: Legislative Decree 139/2005; and Law 248/2006.*

**(f) Architecture and urban planning services, engineering and integrated engineering services (CPC 8671, 8672, 8673, 8674)**

With respect to Investment liberalisation – Market access:

In **FR**: An architect may only establish in France in order to provide architectural services using one of the following legal forms (on a non-discriminatory basis): SA et SARL (sociétés anonymes, à responsabilité limitée), EURL (Entreprise unipersonnelle à responsabilité limitée), SCP (en commandite par actions), SCOP (Société coopérative et participative), SELARL (société d'exercice libéral à responsabilité limitée), SELAFA (société d'exercice libéral à forme anonyme), SELAS (société d'exercice libéral ) or SAS (Société par actions simplifiée), or as individual or as a partner in an architectural firm (CPC 8671).

**Measures:**

*FR: Loi 90-1258 relative à l'exercice sous forme de société des professions libérales; Décret 95-129 du 2 février 1995 relatif à l'exercice en commun de la profession d'architecte sous forme de société en participation;*

*Décret 92-619 du 6 juillet 1992 relatif à l'exercice en commun de la profession d'architecte sous forme de société d'exercice libéral à responsabilité limitée SELARL, société d'exercice libéral à forme anonyme SELAFA, société d'exercice libéral en commandite par actions SELCA; and Loi 77-2 du 3 janvier 1977.*

With respect to Investment liberalisation – Market access, National treatment and Cross-border trade in services – Market access, National treatment:

In **BG**: Residency in the EEA or the Swiss Confederation is required for architecture, urban planning and engineering services provided by natural persons.

**Measures:**

*BG: Spatial Development Act;*

*Chamber of Builders Act; and*

*Chambers of Architects and Engineers in Project Development Design Act.*

With respect to Investment liberalisation – National treatment and Cross-border trade in services – National treatment:

In **HR**: A design or project created by a foreign architect, engineer or urban planner must be validated by an authorised natural or legal person in Croatia with regard to its compliance with Croatian Law (CPC 8671, 8672, 8673, 8674).

**Measures:**

*HR: Act on Physical Planning and Building Activities (OG 118/18, 110/19)*

*Physical Planning Act (OG 153/13, 39/19).*

With respect to Investment liberalisation – Market access, National treatment and Cross-border trade in services – National treatment, Local presence:

In **CY**: Nationality and residency condition applies for the provision of architecture and urban planning services, engineering and integrated engineering services (CPC 8671, 8672, 8673, 8674).

**Measures:**

**CY**: *Law 41/1962 as amended; Law 224/1990 as amended; and Law 29(I)2001 as amended.*

With respect to Cross-border trade in services – Local presence:

In **CZ**: Residency in the EEA is required.

In **HU**: EEA residency is required for the supply of the following services, insofar as they are being supplied by a natural person present in the territory of Hungary: architectural services, engineering services (only applicable to graduate trainees), integrated Engineering services and landscape architectural services (CPC 8671, 8672, 8673, 8674).

In **IT**: residency or professional domicile/business address in Italy is required for enrolment in the professional register, which is necessary for the exercise of architectural and engineering services (CPC 8671, 8672, 8673, 8674).

In **SK**: Residency in the EEA is required for registration in the professional chamber, which is necessary for the exercise of architectural and engineering services (CPC 8671, 8672, 8673, 8674).

**Measures:**

**CZ**: *Act no. 360/1992 Coll. on practice of profession of authorised architects and authorised engineers and technicians working in the field of building constructions.*

**HU**: *Act LVIII of 1996 on the Professional Chambers of Architects and Engineers.*

**IT**: *Royal Decree 2537/1925 regulation on the profession of architect and engineer; Law 1395/1923; and*

*Decree of the President of the Republic (D.P.R.) 328/2001.*

**SK**: *Act 138/1992 on Architects and Engineers, Articles 3, 15, 15a, 17a and 18a.*

With respect to Cross-border trade in services – Market access, National treatment:

In **BE**: the provision of architectural services includes control over the execution of the works (CPC 8671, 8674). Foreign architects authorised in their host countries and wishing to practice their profession on an occasional basis in Belgium are required to obtain prior authorisation from the Council of Order in the geographical area where they intend to practice their activity.

**Measures:**

**BE**: *Law of February 20, 1939 on the protection of the title of the architect's profession; and*

*Law of 26th June 1963, which creates the Order of Architects Regulations of December 16th,*

*1983 of ethics established by national Council in the Order of Architects (Approved by Article 1st of A.R. of April 18th, 1985, M.B., May 8th, 1985).*

**Reservation No. 3 - Professional services (health related and retail of pharmaceuticals)**

**Sector – sub-sector:** Professional services – medical (including psychologists) and dental services; midwives, nurses, physiotherapists and paramedical personnel; veterinary services; retail sales of pharmaceutical, medical and orthopaedic goods and other services provided by pharmacists

**Industry classification:** CPC 9312, 93191, 932, 63211

**Type of reservation:** Market access  
National treatment  
Most-favoured-nation treatment  
Senior management and boards of directors  
Local presence

**Chapter:** Investment Liberalisation and Cross-Border Trade in Services

**Description:**

**(a) *Medical, dental, midwives, nurses, physiotherapists and para-medical services (CPC 852, 9312, 93191)***

With respect to Investment liberalisation – National treatment, Most favoured nation treatment and Cross-border trade in services – National treatment, Most favoured nation treatment:

In **IT**: European Union nationality is required for the services provided by psychologists, foreign professionals may be allowed to practice based on reciprocity (part of CPC 9312).

**Measures:**

*IT: Law 56/1989 on the psychologist profession.*

With respect to Investment liberalisation – Market access, National treatment and Cross-border trade in services – Market Access, National treatment, Local presence:

In **CY**: Cypriot nationality and residency condition applies for the provision of medical (including psychologists), dental, midwives, nurses, physiotherapists and para-medical services.

**Measures:**

*CY: Registration of Doctors Law (Chapter 250) as amended;*

*Registration of Dentists Law (Chapter 249) as amended;*

*Law 75(I)/2013 - Podologists;*

*Law 33(I)/2008 as amended- Medical Physics;*

*Law 34(I)/2006 as amended - Occupational Therapists;*

*Law 9(I)/1996 as amended - Dental Technicians;*

*Law 68(I)/1995 as amended - Psychologists;*

*Law 16(I)/1992 as amended - Opticians;*

*Law 23(I)/2011 as amended - Radiologists/Radiotherapists;*

*Law 31(I)/1996 as amended - Dieticians/Nutritionists;*

*Law 140/1989 as amended - Physiotherapists; and*

*Law 214/1988 as amended - Nurses.*

With respect to Investment liberalisation – Market Access and Cross-border trade in services – Market Access, Local presence:

In **DE** (applies also to the regional level of government): Geographical restrictions may be imposed on professional registration, which apply to nationals and non-nationals alike.

Doctors (including psychologists, psychotherapists, and dentists) need to register with the regional associations of statutory health insurance physicians or dentists (kassenärztliche or kassenzahnärztliche Vereinigungen), if they wish to treat patients insured by the statutory sickness funds. This registration can be subject to quantitative restrictions based on the regional distribution of doctors. For dentists this restriction does not apply. Registration is necessary only for doctors participating in the public health scheme. Non-discriminatory restrictions on the legal form of establishment required to provide these services may exist (§ 95 SGB V).

For midwives services, access is restricted to natural persons only. For medical and dental services, access is possible for natural persons, licensed medical care centres and mandated bodies. Establishment requirements may apply.

Regarding telemedicine, the number of ICT (information and communications technology) - service suppliers may be limited to guarantee interoperability, compatibility and necessary safety standards. This is applied in a non-discriminatory way (CPC 9312, 93191).

**Measures:**

*Bundesärztleordnung (BÄO; Federal Medical Regulation);*

*Gesetz über die Ausübung der Zahnheilkunde (ZHG);*

*Gesetz über den Beruf der Psychotherapeutin und des Psychotherapeuten (PsychThG; Act on the Provision of Psychotherapy Services);*

*Gesetz über die berufsmäßige Ausübung der Heilkunde ohne Bestallung (Heilpraktikergesetz);*

*Gesetz über das Studium und den Beruf von Hebammen(HebG);*

*Gesetz über die Pflegeberufe (PflBG);*

*Sozialgesetzbuch Fünftes Buch (SGB V; Social Code, Book Five) - Statutory Health Insurance.*

*Regional level:*

*Heilberufekammergesetz des Landes Baden-Württemberg ;*

*Gesetz über die Berufsausübung, die Berufsvertretungen und die Berufsgerichtsbarkeit der Ärzte, Zahnärzte, Tierärzte, Apotheker sowie der Psychologischen Psychotherapeuten und der Kinder- und Jugendlichenpsychotherapeuten (Heilberufe-Kammergesetz - HKaG) in Bayern;*

*Berliner Heilberufekammergesetz (BlHKG);*

*Heilberufsgesetz Brandenburg (HeilBerG);*

*Bremisches Gesetz über die Berufsvertretung, die Berufsausübung, die Weiterbildung und die Berufsgerichtsbarkeit der Ärzte, Zahnärzte, Psychotherapeuten, Tierärzte und Apotheker (Heilberufsgesetz - HeilBerG);*

*Heilberufsgesetz Mecklenburg-Vorpommern (Heilberufsgesetz M-V – HeilBerG);*

*Heilberufsgesetz (HeilBG NRW);*

*Heilberufsgesetz (HeilBG Rheinland-Pfalz);*

*Gesetz über die öffentliche Berufsvertretung, die Berufspflichten, die Weiterbildung und die Berufsgerichtsbarkeit der Ärzte/ Ärztinnen, Zahnärzte/ Zahnärztinnen, psychologischen Psychotherapeuten/ Psychotherapeutinnen und Kinder- und Jugendlichenpsychotherapeuten/psychotherapeutinnen, Tierärzte/Tierärztinnen und Apotheker/Apothekerinnen im Saarland (Saarländisches Heilberufekammergesetz - SHKG);*

*Gesetz über Berufsausübung, Berufsvertretungen und Berufsgerichtsbarkeit der Ärzte, Zahnärzte, Tierärzte, Apotheker sowie der Psychologischen Psychotherapeuten und der Kinder und Jugendlichenpsychotherapeuten im Freistaat (Sächsisches Heilberufekammergesetz – SächsHKaG)and Thüringer Heilberufegesetz.*

With respect to Investment liberalisation – Market access, National treatment and Cross-border trade in services – Market Access, Local presence:

In **FR**: While other types of legal form are also available for Union investors, foreign investors only have access to the legal forms of "société d'exercice libéral"(SEL) and "société civile professionnelle" (SCP). For medical, dental and midwives services, French nationality is required. However, access by foreigners is possible within annually established quotas. For medical, dental and midwives services and services by nurses, provision through SEL à forme anonyme, à responsabilité limitée par actions simplifiée ou en commandite par actions SCP, société coopérative (for independent general and specialised practitioners only) or société interprofessionnelle de soins ambulatoires (SISA) for multidisciplinary health home (MSP) only.

**Measures:**

**FR:** *Loi 90-1258 relative à l'exercice sous forme de société des professions libérales, Loi n°2011-940 du 10 août 2011 modifiant certaines dispositions de la loi n°2009-879 dite HPST, Loi n°47-1775 portant statut de la coopération; and Code de la santé publique.*

With respect to Investment liberalisation – Market access:

In **AT:** Cooperation of physicians for the purpose of ambulatory public healthcare, so-called group practices, can take place only under the legal form of Offene Gesellschaft/OG or Gesellschaft mit beschränkter Haftung/GmbH. Only physicians may act as associates of such a group practice. They must be entitled to independent medical practice, registered with the Austrian Medical Chamber and actively pursue the medical profession in the practice. Other natural or legal persons may not act as associates of the group practice and may not take share in its revenues or profits (part of CPC 9312).

**Measures:**

**AT:** *Medical Act, BGBl. I Nr. 169/1998, §§ 52a - 52c;*

*Federal Act Regulating High Level Allied Health Professions, BGBl. Nr. 460/1992; and Federal Act regulating Medical Masseurs lower and upper level, BGBl. Nr. 169/2002.*

**(b) Veterinary services (CPC 932)**

With respect to Investment liberalisation – Market access, National treatment, Most-favoured nation treatment and Cross-border trade in services – Market access, National treatment, Most-favoured nation treatment:

In **AT:** Only nationals of a Member State of the EEA may provide veterinary services. The nationality requirement is waived for nationals of a non-Member State of the EEA where there is a Union agreement with that non-Member State of the EEA providing for national treatment with respect to investment and cross-border trade of veterinary services.

In **ES:** Membership in the professional association is required for the practice of the profession and requires Union nationality, which may be waived through a bilateral professional agreement. The provision of veterinary services is restricted to natural persons.

In **FR:** EEA nationality is required for the supply of veterinary services, but the nationality requirement may be waived subject to reciprocity. The legal forms available to a company providing veterinary services are limited to SCP (Société civile professionnelle) and SEL (Société d'exercice libéral).

Other legal forms of company provided for by French domestic law or the law of another Member State of the EEA and having their registered office, central administration or principal place of business therein may be authorised, under certain conditions.

**Measures:**

**AT:** *Tierärztegesetz (Veterinary Act), BGBl. Nr. 16/1975, §3 (2) (3).*

**ES:** *Real Decreto 126/2013, de 22 de febrero, por el que se aprueban los Estatutos Generales de la Organización Colegial Veterinaria Española; Articles 62 and 64.*

**FR:** *Code rural et de la pêche maritime.*

With respect to Investment liberalisation – Market access, National treatment and Cross-border trade in services – National treatment, Local presence:

In **CY:** Nationality and residency condition applies for the provision of veterinary services.

In **EL:** EEA or Swiss nationality is required for the supply of veterinary services.

In **HR:** Only legal and natural persons established in a Member State for the purpose of conducting veterinary activities can supply cross border veterinary services in the Republic of Croatia. Only Union nationals can establish a veterinary practice in the Republic of Croatia.

In **HU:** EEA nationality is required for membership of the Hungarian Veterinary Chamber, necessary for supplying veterinary services. Authorisation for establishment is subject to an economic needs test. Main criteria: labour market conditions in the sector.

**Measures:**

**CY:** *Law 169/1990 as amended.*

**EL:** *Presidential Degree 38/2010, Ministerial Decision 165261/IA/2010 (Gov. Gazette 2157/B).*

**HR:** *Veterinary Act (OG 83/13, 148/13, 115/18), Articles 3 (67), Articles 105 and 121.*

**HU:** *Act CXXVII of 2012 on the Hungarian Veterinary Chamber and on the conditions how to supply Veterinary services.*

With respect to Cross-border trade in services – Local presence:

In **CZ:** Physical presence in the territory is required for the supply of veterinary services.

In **IT** and **PT:** Residency is required for the supply of veterinary services.

In **PL:** Physical presence in the territory is required for the supply of veterinary services to pursue the profession of veterinary surgeon present in the territory of Poland, non-European Union nationals have to pass an exam in Polish language organized by the Polish Chambers of Veterinary Surgeons.

In **SI:** Only legal and natural persons established in a Member State for the purpose of conducting veterinary activities can supply cross border veterinary services in to the Republic of Slovenia.

With respect to Investment liberalisation – Market acces, and Cross-border trade in services – Market Access:

In **SK:** Residency in the EEA is required for registration in the professional chamber, which is necessary for the exercise of the profession. The provision of veterinary services is restricted to natural persons.

**Measures:**

**CZ:** *Act No. 166/1999 Coll. (Veterinary Act), §58-63, 39; and*

*Act No. 381/1991 Coll. (on the Chamber of Veterinary Surgeons of the Czech Republic), paragraph 4.*



*IT: Legislative Decree C.P.S. 233/1946, Articles 7-9; and*

*Decree of the President of the Republic (DPR) 221/1950, paragraph 7.*

*PL: Law of 21st December 1990 on the Profession of Veterinary Surgeon and Chambers of Veterinary Surgeons.*

*PT: Decree-Law 368/91 (Statute of the Veterinary Professional Association) alterado p/ Lei 125/2015, 3 set.*

*SI: Pravilnik o priznavanju poklicnih kvalifikacij veterinarjev (Rules on recognition of professional qualifications for veterinarians), Uradni list RS, št. (Official Gazette No) 71/2008, 7/2011, 59/2014 in 21/2016, Act on services in the internal market, Official Gazette RS No 21/2010.*

*SK: Act 442/2004 on Private Veterinary Doctors and the Chamber of Veterinary Doctors, Article 2.*

With respect to Investment liberalisation – Market access and Cross-border trade in services – Market access:

In **DE** (applies also to the regional level of government): The supply of veterinary services is restricted to natural persons. Telemedicine may only be provided in the context of a primary treatment involving the prior physical presence of a veterinary.

In **DK** and **NL**: The supply of veterinary services is restricted to natural persons.

In **IE**: The supply of veterinary services is restricted to natural persons or partnerships.

In **LV**: The supply of veterinary services is restricted to natural persons.

**Measures:**

*DE: Bundes-Tierärzteordnung (BTÄO; Federal Code for the Veterinary Profession).*

*Regional level:*

*Acts on the Councils for the Medical Profession of the Länder (Heilberufs- und*

*Kammergesetze der Länder) and (based on these)*

*Baden-Württemberg, Gesetz über das Berufsrecht und die Kammern der Ärzte, Zahnärzte, Tierärzte Apotheker, Psychologischen Psychotherapeuten sowie der Kinder- und Jugendlichenpsychotherapeuten (Heilberufe-Kammergesetz - HBKG);*

*Bayern, Gesetz über die Berufsausübung, die Berufsvertretungen und die Berufsgerichtsbarkeit der Ärzte, Zahnärzte, Tierärzte, Apotheker sowie der Psychologischen Psychotherapeuten und der Kinder- und Jugendlichenpsychotherapeuten (Heilberufe-Kammergesetz - HKaG);*

*Berliner Heilberufekammergesetz (BlHKKG);*

*Brandenburg, Heilberufsgesetz (HeilBerG);*

*Bremen, Gesetz über die Berufsvertretung, die Berufsausübung, die Weiterbildung und die Berufsgerichtsbarkeit der Ärzte, Zahnärzte, Psychotherapeuten, Tierärzte und Apotheker (Heilberufsgesetz - HeilBerG);*

*Hamburg, Hamburgisches Kammergesetz für die Heilberufe (HmbKGGH);*

*Hessen, Gesetz über die Berufsvertretungen, die Berufsausübung, die Weiterbildung und die Berufsgerichtsbarkeit der Ärzte, Zahnärzte, Tierärzte, Apotheker, Psychologischen Psychotherapeuten und Kinder- und Jugendlichenpsychotherapeuten (Heilberufsgesetz);*

*Mecklenburg-Vorpommern, Heilberufsgesetz (HeilBerG);*

*Niedersachsen, Kammergesetz für die Heilberufe (HKG);*

*Nordrhein-Westfalen, Heilberufsgesetz NRW (HeilBerG);*

*Rheinland-Pfalz, Heilberufsgesetz (HeilBG);*

*Saarland, Gesetz Nr. 1405 über die öffentliche Berufsvertretung, die Berufspflichten, die Weiterbildung und die Berufsgerichtsbarkeit der Ärzte/Ärztinnen, Zahnärzte/Zahnärztinnen, Tierärzte/Tierärztinnen und Apotheker/Apothekerinnen im Saarland (Saarländisches Heilberufekammergesetz - SHKG);*

*Sachsen, Gesetz über Berufsausübung, Berufsvertretungen und Berufsgerichtsbarkeit der Ärzte, Zahnärzte, Tierärzte, Apotheker sowie der Psychologischen Psychotherapeuten und der Kinder- und Jugendlichenpsychotherapeuten im Freistaat Sachsen (Sächsisches Heilberufekammergesetz – SächsHKaG);*

*Sachsen-Anhalt, Gesetz über die Kammern für Heilberufe Sachsen-Anhalt (KGHB-LSA);*

*Schleswig-Holstein, Gesetz über die Kammern und die Berufsgerichtsbarkeit für die Heilberufe (Heilberufekammergesetz - HBKG);*

*Thüringen, Thüringer Heilberufegesetz (ThürHeilBG); and*

*Berufsordnungen der Kammern (Codes of Professional Conduct of the Veterinary Practitioners' Councils).*

*DK: Lovbekendtgørelse nr. 40 af lov om dyrlæger af 15. januar 2020 (Consolidated act no. 40 of January 15th, 2020, on veterinary surgeons).*

*IE: Veterinary Practice Act 2005.*

*LV: Veterinary Medicine Law.*

*NL: Wet op de uitoefening van de diergeneeskunde 1990 (WUD).*

**(c) Retail sales of pharmaceuticals, medical and orthopaedic goods and other services provided by pharmacists (CPC 63211)**

With respect to Investment liberalisation – Market access, National treatment, Senior management and boards of directors:

In **AT**: The retail of pharmaceuticals and specific medical goods to the public may only be carried out through a pharmacy. Nationality of a Member State of the EEA or the Swiss Confederation is required in order to operate a pharmacy. Nationality of a Member State of the EEA or the Swiss Confederation is required for leaseholders and persons in charge of managing a pharmacy.

**Measures:**

**AT**: *Apothekengesetz (Pharmacy Law), RGBl. Nr. 5/1907 as amended, §§ 3, 4, 12; Arzneimittelgesetz (Medication Act), BGBl. Nr. 185/1983 as amended, §§ 57, 59, 59a; and Medizinproduktegesetz (Medical Products Law), BGBl. Nr. 657/1996 as amended, § 99.*

With respect to Investment liberalisation – Market Access, National Treatment:

In **DE**: Only natural persons (pharmacists) are permitted to operate a pharmacy. Nationals of other countries or persons who have not passed the German pharmacy exam may only obtain a licence to take over a pharmacy which has already existed during the preceding three years. The total number of pharmacies per person is restricted to one pharmacy and up to three branch pharmacies.

In **FR**: EEA or Swiss nationality is required in order to operate a pharmacy.

Foreign pharmacists may be permitted to establish within annually established quotas. Pharmacy opening must be authorised and commercial presence including sale at a distance of medicinal products to the public by means of information society services, must take one of the legal forms which are allowed under national law on a non-discriminatory basis: société d'exercice libéral (SEL) anonyme, par actions simplifiée, à responsabilité limitée unipersonnelle or pluripersonnelle, en commandite par actions, société en noms collectifs (SNC) or société à responsabilité limitée (SARL) unipersonnelle or pluripersonnelle only.

**Measures:**

**DE**: *Gesetz über das Apothekenwesen (ApoG; German Pharmacy Act);*

*Gesetz über den Verkehr mit Arzneimitteln (AMG);*

*Gesetz über Medizinprodukte (MPG);*

*Verordnung zur Regelung der Abgabe von Medizinprodukten (MPAV)*

**FR**: *Code de la santé publique; and*

*Loi 90-1258 du 31 décembre 1990 relative à l'exercice sous forme de société des professions libérales and Loi 2015-990 du 6 août 2015.*

With respect to Investment liberalisation – National Treatment:

In **EL**: European Union nationality is required in order to operate a pharmacy.

In **HU**: EEA nationality is required in order to operate a pharmacy.

In **LV**: In order to commence independent practice in a pharmacy, a foreign pharmacist or pharmacist's assistant, educated in a state which is not a Member State or a Member State of the

EEA, must work for at least one year in a pharmacy in a Member State of the EEA under the supervision of a pharmacist.

**Measures:**

**EL:** Law 5607/1932 as amended by Laws 1963/1991 and 3918/2011.

**HU:** Act XCVIII of 2006 on the General Provisions Relating to the Reliable and Economically Feasible Supply of Medicinal Products and Medical Aids and on the Distribution of Medicinal Products.

**LV:** Pharmaceutical Law, s. 38.

With respect to Investment liberalisation – Market access:

In **BG:** Managers of pharmacies must be qualified pharmacists and may only manage one pharmacy in which they themselves work. A quota (not more than 4) exists for the number of pharmacies which may be owned per person in the Republic of Bulgaria.

In **DK:** Only natural persons, who have been granted a pharmacist licence from the Danish Health and Medicines Authority, are permitted to provide retail services of pharmaceuticals and specific medical goods to the public.

In **ES, HR, HU, and PT:** Establishment authorisation is subject to an economic needs test.

Main criteria: population and density conditions in the area.

In **IE:** The mail order of pharmaceuticals is prohibited, with the exception of non-prescription medicines.

In **MT:** Issuance of Pharmacy licences under specific restrictions. No person shall have more than one licence in his name in any town or village (Regulation 5(1) of the Pharmacy Licence Regulations (LN279/07)), except in the case where there are no further applications for that town or village (Regulation 5(2) of the Pharmacy Licence Regulations (LN279/07)).

In **PT:** In commercial companies where the capital is represented by shares, these shall be nominative. A person shall not hold or exercise, at the same time, directly or indirectly, ownership, operation or management of more than four pharmacies.

In **SI:** The network of pharmacies in Slovenia consists of public pharmacy institutions, owned by municipalities, and of private pharmacists with concession where the majority owner must be a pharmacist by profession. Mail order of pharmaceuticals requiring a prescription is prohibited.

**Measures:**

**BG:** Law on Medicinal Products in Human Medicine, arts. 222, 224, 228.

**DK:** Apotekerloven (Danish Pharmacy Act) LBK nr. 801 12/06/2018.

**ES:** Ley 16/1997, de 25 de abril, de regulación de servicios de las oficinas de farmacia (Law 16/1997, of 25 April, regulating services in pharmacies), Articles 2, 3.1; and

*Real Decreto Legislativo 1/2015, de 24 de julio por el que se aprueba el Texto refundido de la Ley de garantías y uso racional de los medicamentos y productos sanitarios (Ley 29/2006).*

**HR:** *Health Care Act (OG 100/18, 125/19).*

**HU:** *Act XCVIII of 2006 on the General Provisions Relating to the Reliable and Economically Feasible Supply of Medicinal Products and Medical Aids and on the Distribution of Medicinal Products.*

**IE:** *Irish Medicines Boards Acts 1995 and 2006 (No. 29 of 1995 and No. 3 of 2006); Medicinal Products (Prescription and Control of Supply) Regulations 2003, as amended (S.I. 540 of 2003); Medicinal Products (Control of Placing on the Market) Regulations 2007, as amended (S.I. 540 of 2007); Pharmacy Act 2007 (No. 20 of 2007); Regulation of Retail Pharmacy Businesses Regulations 2008, as amended, (S.I. No 488 of 2008)*

**MT:** *Pharmacy Licence Regulations (LN279/07) issued under the Medicines Act (Cap. 458).*

**PT:** *Decree-Law 307/2007, Articles 9, 14 and 15 Alterado p/ Lei 26/2011, 16 jun., alterada:*

- *p/ Acórdão TC 612/2011, 24/01/2012,*

- *p/ Decreto-Lei 171/2012, 1 ago.,*

- *p/ Lei 16/2013, 8 fev.,*

- *p/ Decreto-Lei 128/2013, 5 set.,*

- *p/ Decreto-Lei 109/2014, 10 jul.,*

- *p/ Lei 51/2014, 25 ago.,*

- *p/ Decreto-Lei 75/2016, 8 nov.; and Ordinance 1430/2007 revogada p/ Portaria 352/2012, 30 out.*

**SI:** *Pharmacy Services Act (Official Gazette of the RS No. 85/2016); and Medicinal Products Act (Official Gazette of the RS, No. 17/2014).*

With respect to Investment liberalisation – Market Access, National treatment, Most-Favoured Nation treatment and Cross-border trade in services – Market access, National treatment:

In **IT:** The practice of the profession is possible only for natural persons enrolled in the register, as well as for legal persons in the form of partnerships, where every partner of the company must be an enrolled pharmacist. Enrolment in the pharmacist professional register requires nationality of a Member State of the European Union or residency and the practice of the profession in Italy. Foreign nationals having the necessary qualifications may enrol if they are citizens of a country with whom Italy has a special agreement, authorising the exercise of the profession, under condition of reciprocity (D. Lgs. CPS 233/1946 Articles 7-9 and D.P.R. 221/1950 paragraphs 3 and 7). New or vacant pharmacies are authorised following a public competition. Only nationals of a Member State of the European Union enrolled in the Register of pharmacists ("albo") are able to participate in a public competition.

Establishment authorisation is subject to an economic needs test. Main criteria: population and density conditions in the area.

**Measures:**

*IT: Law 362/1991, Articles 1, 4, 7 and 9;*

*Legislative Decree CPS 233/1946, Articles 7-9; and*

*Decree of the President of the Republic (D.P.R. 221/1950, paragraphs 3 and 7).*

With respect to Investment liberalisation – Market Access, National treatment and Cross-border trade in services – Market access, National treatment:

In **CY**: Nationality requirement applies for the provision of retail sales of pharmaceuticals, medical and orthopaedic goods and other services provided by pharmacists (CPC 63211).

**Measures:**

*CY: Pharmacy and Poisons Law (Chapter 254) as amended.*

With respect to Investment liberalisation – Market Access and Cross-border services – Market access:

In **BG**: The retail of pharmaceuticals and specific medical goods to the public may only be carried out through a pharmacy. The mail order of pharmaceuticals is prohibited, with the exception of non-prescription medicines.

In **EE**: The retail of pharmaceuticals and specific medical goods to the public may only be carried out through a pharmacy. Mail order sale of medicinal products as well as delivery by post or express service of medicinal products ordered through the Internet is prohibited. Establishment authorisation is subject to an economic needs test. Main criteria: density conditions in the area.

In **EL**: Only natural persons, who are licenced pharmacists, and companies founded by licenced pharmacists, are permitted to provide retail services of pharmaceuticals and specific medical goods to the public.

In **ES**: Only natural persons, who are licenced pharmacists, are permitted to provide retail services of pharmaceuticals and specific medical goods to the public. Each pharmacist cannot obtain more than one licence.

In **LU**: Only natural persons are permitted to provide retail services of pharmaceuticals and specific medical goods to the public.

In **NL**: Mail order of medicine is subject to requirements.

**Measures:**

*BG: Law on Medicinal Products in Human Medicine, arts.219, 222, 228, 234(5).*

*EE: Ravimiseadus (Medicinal Products Act), RT I 2005, 2, 4; § 29 (2) and § 41 (3); and Tervishoiuteenuse korraldamise seadus (Health Services Organisation Act, RT I 2001, 50, 284).*

*EL: Law 5607/1932 as amended by Laws 1963/1991 and 3918/2011.*

*ES: Ley 16/1997, de 25 de abril, de regulación de servicios de las oficinas de farmacia (Law*

16/1997, of 25 April, regulating services in pharmacies), Articles 2, 3.1; and

Real Decreto Legislativo 1/2015, de 24 de julio por el que se aprueba el Texto refundido de la Ley de garantías y uso racional de los medicamentos y productos sanitarios (Ley 29/2006).

**LU:** Loi du 4 juillet 1973 concernant le régime de la pharmacie (annex a043);

Règlement grand-ducal du 27 mai 1997 relatif à l'octroi des concessions de pharmacie (annex a041);  
and

Règlement grand-ducal du 11 février 2002 modifiant le règlement grand-ducal du 27 mai 1997 relatif à l'octroi des concessions de pharmacie (annex a017).

**NL:** Geneesmiddelenwet, article 67.

With respect to Investment liberalisation – National treatment and Cross-border services – Local presence:

In **BG:** Permanent residency is required for pharmacists.

**Measures:**

**BG:** Law on Medicinal Products in Human Medicine, arts. 146, 161, 195, 222, 228.

With respect to Cross-border trade in services – Local presence:

In **DE, SK:** Residency is required in order to obtain a licence as a pharmacist or to open a pharmacy for the retail of pharmaceuticals and certain medical goods to the public.

**Measures:**

**DE:** Gesetz über das Apothekenwesen (ApoG; German Pharmacy Act);

Gesetz über den Verkehr mit Arzneimitteln (AMG);

Gesetz über Medizinprodukte (MPG);

Verordnung zur Regelung der Abgabe von Medizinprodukten (MPAV).

**SK:** Act 362/2011 on pharmaceuticals and medical devices, Article 6; and

Act 578/2004 on healthcare providers, medical employees, professional organisation in healthcare.

#### **Reservation No. 4 - Research and development services**

<b>Sector – sub-sector:</b>	Research and development (R&D) services
<b>Industry classification:</b>	CPC 851, 853
<b>Type of reservation:</b>	Market access National treatment
<b>Chapter:</b>	Investment liberalisation and Cross-border trade in services
<b>Level of government:</b>	EU/ Member State (unless otherwise specified)

#### **Description:**

The **EU**: For publicly funded research and development (R&D) services benefitting from funding provided by the European Union at the European Union level, exclusive rights or authorisations may only be granted to nationals of the Member States of the European Union and to legal persons of the European Union having their registered office, central administration or principal place of business in the European Union (CPC 851, 853).

For publicly funded R&D services benefitting from funding provided by a Member State exclusive rights or authorisations may only be granted to nationals of the Member State of the European Union concerned and to legal persons of the Member State concerned having their headquarters in that Member State (CPC 851, 853).

This reservation is without prejudice to Part Five [Participation in Union Programmes, Sound Financial Management and Financial Provisions] and to the exclusion of procurement by a Party or subsidies, in paragraphs 6 and 7 of Article SERVIN.1.1 [Objective and scope].

#### **Measures:**

**EU**: All currently existing and all future Union research or innovation framework programmes, including the Horizon 2020 Rules for Participation and regulations pertaining to Joint Technology Initiatives (JTIs), Article 185 Decisions, and the European Institute for Innovation and Technology (EIT), as well as existing and future national, regional or local research programmes.



## Reservation No. 5 - Real estate services

<b>Sector – sub-sector:</b>	Real estate services
<b>Industry classification:</b>	CPC 821, 822
<b>Type of reservation:</b>	Market access National treatment Most-favoured-nation treatment Local presence
<b>Chapter:</b>	Investment liberalisation and Cross-border trade in services
<b>Level of government:</b>	EU/ Member State (unless otherwise specified)

### Description:

With respect to Investment liberalisation – Market Access, National treatment and Cross-border trade in services – National treatment, Local presence:

In **CY**: For the supply of real estate services, nationality and residency condition applies.

### Measures:

**CY**: *The Real Estate Agents Law 71(1)/2010 as amended.*

With respect to Cross-border trade in services – Local presence:

In **CZ**: Residency for natural persons and establishment for legal persons in the Czech Republic are required to obtain the licence necessary for the provision of real estate services.

In **HR**: Commercial presence in EEA is required to supply real estate services.

In **PT**: EEA residency is required for natural persons. EEA incorporation is required for legal persons.

### Measures:

**CZ**: *Trade Licensing Act.*

**HR**: *Real Estate Brokerage Act (OG 107/07 and 144/12), Article 2.*

**PT**: *Decree-Law 211/2004 (Articles 3 and 25), as amended and republished by Decree-Law 69/2011.*

With respect to Investment liberalisation – National treatment and Cross-border trade in services – Local presence:

In **DK**: For the supply of real estate services by a natural person present in the territory of

Denmark, only authorised real estate agent who are natural persons that have been admitted to the Danish Business Authority's real estate agent register may use the title of "real estate agent". The act

requires that the applicant be a Danish resident or a resident of the Union, EEA or the Swiss Confederation.

The Act on the sale of real estate is only applicable when providing real estate services to consumers. The Act on the sale of real estate does not apply to the leasing of real estate (CPC 822).

**Measures:**

**DK:** *Lov om formidling af fast ejendom m.v. lov. nr. 526 af 28.05.2014 (The Act on the sale of real estate).*

With respect to Cross-border trade in services – Market access, National treatment, Most-favoured-nation treatment:

In **SI:** In so far as the United Kingdom allows Slovenian nationals and enterprises to supply real estate agent services, Slovenia will allow nationals of the United Kingdom and enterprises to supply real estate agent services under the same conditions, in addition to the fulfilment of the following requirements: entitlement to act as a real estate agent in the country of origin, submission of the relevant document on impunity in criminal procedures, and inscription into the registry of real estate agents at the competent (Slovenian) ministry.

**Measures:**

**SI:** *Real Estate Agencies Act.*

## Reservation No. 6 - Business services

<b>Sector – sub-sector:</b>	Business services - rental or leasing services without operators; services related to management consulting; technical testing and analyses; related scientific and technical consulting services; services incidental to agriculture; security services; placement services; translation and interpretation services and other business services
<b>Industry classification:</b>	ISIC Rev. 37, part of CPC 612, part of 621, part of 625, 831, part of 85990, 86602, 8675, 8676, 87201, 87202, 87203, 87204, 87205, 87206, 87209, 87901, 87902, 87909, 88, part of 893
<b>Type of reservation:</b>	Market access National treatment Most-favoured-nation treatment Senior management and boards of directors Local presence
<b>Chapter:</b>	Investment liberalisation and Cross-border trade in services
<b>Level of government:</b>	EU/ Member State (unless otherwise specified)

### Description:

#### **(a) Rental or leasing services without operators (CPC 83103, CPC 831)**

##### With respect to Investment liberalisation – Market access, National treatment:

In **SE**: To fly the Swedish flag, proof of dominating Swedish operating influence must be shown in case of foreign ownership interests in ships. Dominating Swedish operating influence means that the operation of the ship is located in Sweden and that the ship also has a more than half of the shares of either Swedish ownership or ownership of persons in another EEA country. Other foreign ships may under certain conditions be granted an exemption from this rule where they are rented or leased by Swedish legal persons through bareboat charter contracts (CPC 83103).

##### **Measures:**

**SE**: *Sjölagen (Maritime Law) (1994:1009), Chapter 1, § 1.*

##### With respect to Cross-border trade in services – Local presence:

In **SE**: Suppliers of rental or leasing services of cars and certain off-road vehicles (terrängmotorfordon) without a driver, rented or leased for a period of less than one year, are obliged to appoint someone to be responsible for ensuring, among other things, that the business is conducted in accordance with applicable rules and regulations and that the road traffic safety rules are followed. The responsible person must reside in the EEA (CPC 831).

##### **Measures:**

**SE**: *Lag (1998: 424) om biluthyrning (Act on renting and leasing cars).*

**(b) Rental or leasing services and other business services related to aviation**

With respect to Investment liberalisation - Market access, National treatment, Most-favoured nation treatment, and Cross-border trade in services - Market access, National treatment, Most-favoured-nation treatment:

The **EU**: For rental or leasing of aircraft without crew (dry lease), aircraft used by an air carrier of the European Union are subject to applicable aircraft registration requirements. A dry lease agreement to which a Union carrier is a party shall be subject to requirements in the Union or national law on aviation safety, such as prior approval and other conditions applicable to the use of third countries' registered aircraft. To be registered, aircraft may be required to be owned either by natural persons meeting specific nationality criteria or by enterprises meeting specific criteria regarding ownership of capital and control (CPC 83104).

With respect to computer reservation system (CRS) services, where Union air carriers are not accorded, by CRS services suppliers operating outside the Union, equivalent (meaning non-discriminatory) treatment to the treatment provided by Union CRS service suppliers to air carriers of a third country in the Union, or where Union CRS services suppliers are not accorded, by non-European Union air carriers, equivalent treatment to the treatment provided by air carriers in the Union to CRS service suppliers of a third country, measures may be taken to accord the equivalent discriminatory treatment, respectively, to the non- Union air carriers by the CRS services suppliers operating in the Union, or to the non-European Union CRS services suppliers by Union air carriers.

**Measures:**

**EU**: Regulation (EC) No 1008/2008 of the European Parliament and of the Council of 24 September 2008 on common rules for the operation of air services in the Community (Recast); and Regulation (EC) No 80/2009 of the European Parliament and of the Council of 14 January 2009 on a Code of Conduct for computerised reservation systems and repealing Council Regulation (EEC) No 2299/89.

With respect to Investment liberalisation - National treatment and Cross-border trade in services - Market access, National treatment

In **BE**: Private (civil) aircraft belonging to natural persons who are not nationals of a member state of the EEA may only be registered if they are domiciled or resident in Belgium without interruption for at least one year. Private (civil) aircraft belonging to foreign legal entities not formed in accordance with the law of a member state of the EEA may only be registered if they have a seat of operations, an agency or an office in Belgium without interruption for at least one year (CPC 83104).

Authorisation procedures for aerial fire-fighting, flight training, spraying, surveying, mapping, photography, and other airborne agricultural, industrial and inspection services.

**Measures:**

**BE**: Arrêté Royal du 15 mars 1954 réglementant la navigation aérienne.

**(c) Services related to management consulting – arbitration and conciliation services (CPC 86602)**

With respect to Cross-border trade in services –National treatment, Local presence:

In **BG**: For mediation services, permanent or long-term residency in the republic of Bulgaria is required for citizens of countries other than a member state of the EEA or the Swiss Confederation.

In **HU**: An authorisation, by means of admission into the register, by the minister in charge of the juridical system is required for the pursuit of mediation (such as arbitration and conciliation) activities which may only be granted to legal or natural persons that are established in or resident in Hungary.

**Measures:**

**BG:** *Mediation Act, Art. 8."*

**HU:** *Act LV of 2002 on Mediation.*

**(d) Technical testing and analysis services (CPC 8676)**

With respect to Investment liberalisation – Market access, National treatment and Cross-border trade in services – Market access, National treatment:

In **CY**: The provision of services by chemists and biologists requires nationality of a Member State.

In **FR**: The professions of biologist are reserved for natural persons, EEA nationality required.

**Measures:**

**CY:** *Registration of Chemists Law of 1988 (Law 157/1988), as amended.*

**FR:** *Code de la Santé Publique.*

With respect to Investment liberalisation – Market Access, National treatment and Cross-border trade in services – Local presence:

In **BG**: Establishment in Bulgaria according to the Bulgarian Commercial Act and registration in the Commercial register is required for provision of technical testing and analysis services.

For the periodical inspection for proof of technical condition of road transport vehicles, the person should be registered in accordance with the Bulgarian Commercial Act or the Non-Profit Legal Persons Act, or else be registered in another Member State of the EEA.

The testing and analysis of the composition and purity of air and water may be conducted only by the Ministry of Environment and Water of Bulgaria, or its agencies in co-operation with the Bulgarian Academy of Sciences.

**Measures:**

**BG:** *Technical Requirements towards Products Act;*

*Measurement Act;*

*Clean Ambient Air Act; and*

*Water Act, Ordinance N-32 for the periodical inspection for proof of technical condition of road transport vehicles.*

With respect to Investment liberalisation – National treatment, Most-favoured-nation treatment and Cross-border trade in services –National treatment, Most-favoured-nation treatment, Local presence:

In **IT**: For biologists, chemical analysts, agronomists and "periti agrari", residency and enrolment in the professional register are required. Third country nationals can enrol under condition of reciprocity.

**Measures:**

*IT: Biologists, chemical analysts: Law 396/1967 on the profession of biologists; and Royal Decree 842/1928 on the profession of chemical analysts.*

**(e) Related scientific and technical consulting services (CPC 8675)**

With respect to Investment liberalisation – National treatment, Most-favoured nation treatment and Cross-border trade in services –National treatment, Most-favoured-nation treatment, Local presence:

In **IT**: Residency or professional domicile in Italy is required for enrolment in the geologists' register, which is necessary for the practice of the professions of surveyor or geologist in order to provide services relating to the exploration and the operation of mines, etc. Nationality of a Member State is required; however, foreigners may enrol under condition of reciprocity.

**Measures:**

*IT: Geologists: Law 112/1963, Articles 2 and 5; D.P.R. 1403/1965, Article 1.*

With respect to Investment liberalisation – Market access, National treatment and Cross-border trade in services – National treatment, Local presence:

In **BG**: For natural persons, nationality and residency of a Member State of the EEA or the Swiss Confederation is required in order to execute functions pertinent to geodesy, cartography and cadastral surveying. For legal entities, trade registration under the legislation of a Member State of the EEA or the Swiss Confederation is required.

**Measures:**

*BG: Cadastre and Property Register Act; and Geodesy and Cartography Act.*

With respect to Investment liberalisation – National Treatment and Cross-border trade in services – National treatment:

In **CY**: Nationality requirement applies for the provision of relevant services.

**Measures:**

*CY: Law 224/1990 as amended.*

With respect to Investment liberalisation – Market Access, National Treatment and Cross-border trade in services – Market Access:

In **FR**: For surveying, access through SEL (anonyme, à responsabilité limitée ou en commandite par actions), SCP (Société civile professionnelle), SA and SARL (sociétés anonymes, à responsabilité limitée) only. For exploration and prospecting services establishment is required. This requirement may be waived for scientific researchers, by decision of the Minister of scientific research, in agreement with the Minister of Foreign affairs.

**Measures:**

**FR:** *Loi 46-942 du 7 mai 1946 and décret n°71-360 du 6 mai 1971.*

With respect to Investment liberalisation – Market Access, National Treatment and Cross-border trade in services –National Treatment, Local presence:

In **HR**: Services of basic geological, geodetic and mining consulting as well as related environmental protection consulting services in the territory of Croatia can be carried out only jointly with or through domestic legal persons.

**Measures:**

**HR:** *Ordinance on requirements for issuing approvals to legal persons for performing professional environmental protection activities (OG No.57/10), Arts. 32-35.*

**(f) Services incidental to agriculture (part of CPC 88)**

With respect to Investment liberalisation –National Treatment and Cross-border trade in services – National treatment, Most-favoured-nation treatment, Local presence:

In **IT**: For biologists, chemical analysts, agronomists and "periti agrari", residency and enrolment in the professional register are required. Third country nationals can enrol under condition of reciprocity.

**Measures:**

**IT:** *Biologists, chemical analysts: Law 396/1967 on the profession of biologists; and Royal Decree 842/1928 on the profession of chemical analysts.*

With respect to Investment liberalisation – Market Access, Most-favoured-nation treatment and Cross-border trade in services – Market access Most-favoured-nation treatment:

In **PT**: The professions of biologist, chemical analyst and agronomist are reserved for natural persons. For third-country nationals, reciprocity regime applies in the case of engineers and technical engineers (and not a citizenship requirement). For biologists, there is not a citizenship requirement nor a reciprocity requirement.

**Measures:**

**PT:** *Decree Law 119/92 alterado p/ Lei 123/2015, 2 set. (Ordem Engenheiros);*

*Law 47/2011 alterado p/ Lei 157/2015, 17 set. (Ordem dos Engenheiros Técnicos); and*

*Decree Law 183/98 alterado p/ Lei 159/2015, 18 set. (Ordem dos Biólogos).*

**(g) Security Services (CPC 87302, 87303, 87304, 87305, 87309)**

With respect to Investment liberalisation – Market access, National treatment and Cross-border trade in services – Market access, National treatment, Local presence:

In **IT**: Nationality of a Member State of the European Union and residency is required in order to obtain the necessary authorisation to supply security guard services and the transport of valuables.

In **PT**: The provision of security services by a foreign supplier on a cross-border basis is not allowed.

A nationality requirement exists for specialised personnel.

**Measures:**

*IT: Law on public security (TULPS) 773/1931, Articles 133-141; Royal Decree 635/1940, Article 257.*

*PT: Law 34/2013 alterada p/ Lei 46/2019, 16 maio; and Ordinance 273/2013 alterada p/ Portaria 106/2015, 13 abril.*

With respect to Investment liberalisation – National treatment, Most-Favoured Nation treatment and Cross-border trade in services – Local presence:

In **DK**: Residence requirement for individuals applying for an authorisation to provide security services.

Residence is also required for managers and the majority of members of the board of a legal entity applying for an authorisation to conduct security services. However, residence for management and boards of directors is not required to the extent it follows from international agreements or orders issued by the Minister for Justice.

**Measures:**

*DK: Lovbekendtgørelse 2016-01-11 nr. 112 om vagtvirksomhed.*

With respect to Cross-border trade in services – Local presence:

In **EE**: Residency is required for security guards.

**Measures:**

**EE**: Turvaseadus (Security Act) § 21, § 22.

**(h) Placement Services (CPC 87201, 87202, 87203, 87204, 87205, 87206, 87209)**

With respect to Investment liberalisation – Market access, National treatment and Cross-border trade in services – Market access, National treatment (applies to the regional level of government):

In **BE**: In all Regions in Belgium, a company having its head office outside the EEA has to demonstrate that it supplies placement services in its country of origin. In the Walloon Region, a specific type of legal entity (régulièrement constituée sous la forme d'une personne morale ayant une forme commerciale, soit au sens du droit belge, soit en vertu du droit d'un Etat membre ou régie par celui-ci, quelle que soit sa forme juridique) is required to supply placement services. A company having its head office outside the EEA has to demonstrate that it fulfils the conditions as set out in the Decree (for instance on the type of legal entity). In the German-speaking community, a company having its



head office outside the EEA has to fulfil the admission criteria established by the mentioned Decree (CPC 87202).

**Measures:**

**BE:** *Flemish Region: Article 8, § 3, Besluit van de Vlaamse Regering van 10 december 2010 tot uitvoering van het decreet betreffende de private arbeidsbemiddeling.*

*Walloon Region: Décret du 3 avril 2009 relatif à l'enregistrement ou à l'agrément des agences de placement (Decree of 3 April 2009 on registration of placement agencies), Article 7; and Arrêté du Gouvernement wallon du 10 décembre 2009 portant exécution du décret du 3 avril*

*2009 relatif à l'enregistrement ou à l'agrément des agences de placement (Decision of the Walloon Government of 10 December 2009 implementing the Decree of 3 April 2009 on registration of placement agencies), Article 4.*

*German-speaking community: Dekret über die Zulassung der Leiharbeitsvermittler und die Überwachung der privaten Arbeitsvermittler / Décret du 11 mai 2009 relatif à l'agrément des agences de travail intérimaire et à la surveillance des agences de placement privées, Article 6.*

With respect to Investment liberalisation – National treatment and Cross-border trade in services – National treatment, Local presence:

In **DE:** Nationality of a Member State of the European Union or a commercial presence in the European Union is required in order to obtain a licence to operate as a temporary employment agency (pursuant to s. 3 paragraphs 3 to 5 of this Act on temporary agency work

(Arbeitnehmerüberlassungsgesetz). The Federal Ministry of Labour and Social Affairs may issue a regulation concerning the placement and recruitment of non-EEA personnel for specified professions e.g. for health and care related professions. The licence or its extension shall be refused if establishments, parts of establishments or ancillary establishments which are not located in the EEA are intended to execute the temporary employment (pursuant to Sec. 3 paragraph 2 of the Act on temporary agency work (Arbeitnehmerüberlassungsgesetz).

**Measures:**

**DE:** *Gesetz zur Regelung der Arbeitnehmerüberlassung (AÜG);*

*Sozialgesetzbuch Drittes Buch (SGB III; Social Code, Book Three) - Employment Promotion;*

*Verordnung über die Beschäftigung von Ausländerinnen und Ausländern (BeschV; Ordinance on the Employment of Foreigners).*

With respect to Investment liberalisation – Market access:

In **ES:** Prior to the start of the activity, placement agencies are required to submit a sworn statement certifying the fulfilment of the requirements stated by the current legislation (CPC 87201, 87202).

**Measures:**

**ES:** *Real Decreto-ley 8/2014, de 4 de julio, de aprobación de medidas urgentes para el crecimiento, la competitividad y la eficiencia (tramitado como Ley 18/2014, de 15 de octubre).*

**(i) Translation and interpretation services (CPC 87905)**

With respect to Investment liberalisation – Market access, National treatment and Cross-border trade in services – Market access:

In **BG**: To carry out official translation activities foreign natural persons are required to hold a permit for long-term or permanent residency in the Republic of Bulgaria.

**Measures:**

**BG**: *Regulation for the legalisation, certification and translation of documents.*

With respect to Investment liberalisation – Market access and Cross-border trade in services – Market access:

In **HU**: Official translations, official certifications of translations, and certified copies of official documents in foreign languages may only be provided by the Hungarian Office for Translation and Attestation (OFFI).

In **PL**: Only natural persons may be sworn translators.

**Measures:**

**HU**: *Decree of the Council of Ministers No. 24/1986 on Official translation and interpretation.*

**PL**: *Act of 25 November 2004 on the profession of sworn translator or interpreter (Journal of Laws from 2019 item 1326).*

With respect to Cross-border trade in services –Market Access:

In **FI**: Residency in the EEA is required for certified translators.

**Measures:**

**FI**: *Laki auktorisoiduista kääntäjistä (Act on Authorised Translators) (1231/2007), s. 2(1)).*

With respect to Investment liberalisation – National treatment and Cross-border trade in services – National treatment:

In **CY**: Registration to registry of translators is necessary for the provision of official translation and certification services. Nationality requirement applies.

In **HR**: EEA nationality is required for certified translators.

**Measures:**

**CY**: *The Establishment, Registration and Regulation of the Certified Translator Services in the Republic of Cyprus Law.*

**HR**: *Ordinance on permanent court interpreters (OG 88/2008), Article 2.*

**(j) Other business services (part of CPC 612, part of 621, part of 625, 87901, 87902, 88493, part of 893, part of 85990, 87909, ISIC 37)**

With respect to Investment liberalisation – Market access:

In **SE**: Pawn-shops must be established as a limited liability company or as a branch (part of CPC 87909).

With respect to Investment liberalisation – Market Access, and Cross-border trade in services – Local presence:

In **CZ**: Only an authorised package company is allowed to supply services relating to packaging take-back and recovery and must be a legal person established as a joint-stock company (CPC 88493, ISIC 37).

With respect to Investment liberalisation – Market Access, and Cross-border trade in services – Market Access:

In **NL**: To provide hallmarking services, commercial presence in the Netherlands is required. The hallmarking of precious metal Articles is currently exclusively granted to two Dutch public monopolies (part of CPC 893).

**Measures:**

**CZ**: Act. 477/2001 Coll. (Packaging Act) paragraph 16.

**SE**: Pawn shop act (1995:1000).

**NL**: Waarborgwet 1986.

With respect to Investment liberalisation – Market Access, National Treatment:

In **PT**: Nationality of a Member State is required for the provision of collection agency services and credit reporting services (CPC 87901, 87902).

**Measures:**

**PT**: Law 49/2004.

With respect to Investment liberalisation – Market Access, National Treatment and Cross-border trade in services – Local presence:

In **CZ**: Auction services are subject to licence. To obtain a licence (for the supply of voluntary public auctions), a company must be incorporated in the Czech Republic and a natural person is required to obtain a residency permit, and the company, or natural person must be registered in the Commercial Register of the Czech Republic (part of CPC 612, part of 621, part of 625, part of 85990).

**Measures:**

**CZ**: Act no.455/1991 Coll.;

Trade Licence Act; and

Act no. 26/2000 Coll., on public auctions.

With respect to Cross-border trade in services –Market access:

In **SE**: The economic plan for a building society must be certified by two persons. These persons must be publicly approved by authorities in the EEA (CPC 87909).

**Measures:**

**SE:** *Cooperative building societies law (1991:614).*

## **Reservation No. 7 - Communication services**

<b>Sector – sub-sector:</b>	Communication services - postal and courier services
<b>Industry classification:</b>	Part of CPC 71235, part of 73210, part of 751
<b>Type of reservation:</b>	Market access
<b>Chapter:</b>	Investment liberalisation; Cross-border trade in services
<b>Level of government:</b>	EU/ Member State (unless otherwise specified)

### **Description:**

With respect to Investment liberalisation - Market access and Cross-border trade in services - Market access:

The **EU**: The organisation of the siting of letter boxes on the public highway, the issuing of postage stamps and the provision of the registered mail service used in the course of judicial or administrative procedures may be restricted in accordance with national legislation. Licensing systems may be established for those services for which a general universal service obligation exists. These licences may be subject to particular universal service obligations or a financial contribution to a compensation fund.

### **Measures:**

**EU**: Directive 97/67/EC of the European Parliament and of the Council of 15 December 1997 on common rules for the development of the internal market of Community postal services and the improvement of quality of service.

## **Reservation No. 8 - Construction Services**

<b>Sector – sub-sector:</b>	Construction and related engineering services
<b>Industry classification:</b>	CPC 51
<b>Type of reservation:</b>	National treatment
<b>Chapter:</b>	Investment liberalisation; Cross-border trade in services
<b>Level of government:</b>	EU/ Member State (unless otherwise specified)

### **Description:**

In **CY**: Nationality requirement.

### **Measure:**

*The Registration and Control of Contractors of Building and Technical Works Law of 2001 (29 (I) / 2001), Articles 15 and 52.*

## Reservation No. 9 - Distribution services

<b>Sector – sub-sector:</b>	Distribution services – general, distribution of tobacco
<b>Industry classification:</b>	C CPC 3546, part of 621, 6222, 631, part of 632
<b>Type of reservation:</b>	Market access National treatment Local presence
<b>Chapter:</b>	Investment liberalisation; Cross-border trade in services
<b>Level of government:</b>	EU/ Member State (unless otherwise specified)

### Description:

**(a) Distribution services (CPC 3546, 631, 632 except 63211, 63297, 62276, part of 621)**

#### With respect to Investment liberalisation – Market access:

In **PT**: A specific authorisation scheme exists for the installation of certain retail establishments and shopping centres. This relates to shopping centres that have a gross leasable area equal or greater than 8,000m<sup>2</sup>, and retail establishments having a sales area equal or exceeding 2,000m<sup>2</sup>, when located outside shopping centres. Main criteria: Contribution to a multiplicity of commercial offers; assessment of services to consumer; quality of employment and corporate social responsibility; integration in urban environment; contribution to eco-efficiency (CPC 631, 632 except 63211, 63297).

#### **Measures:**

**PT**: Decree-Law No. 10/2015, 16 January.

#### With respect to Investment liberalisation – Market access, National treatment and Cross-border trade in services – Market access, National treatment:

In **CY**: Nationality requirement exists for distribution services provided by pharmaceutical representatives (CPC 62117).

#### **Measures:**

**CY**: Law 74(I) 2020 as amended.

#### With respect to Investment liberalisation – Market Access and Cross-border trade in services – Local presence:

In **LT**: The distribution of pyrotechnics is subject to licensing. Only legal persons of the Union may obtain a licence (CPC 3546).

#### **Measures:**

**LT**: Law on Supervision of Civil Pyrotechnics Circulation (23 March 2004. No. IX-2074).

**(b) Distribution of tobacco (part of CPC 6222, 62228, part of 6310, 63108)**

With respect to Investment liberalisation – Market access, National treatment and Cross-border trade in services – Market access, National treatment:

In **ES**: There is a state monopoly on retail sales of tobacco. Establishment is subject to a Member State nationality requirement. Only natural persons may operate as a tobacconist. Each tobacconist cannot obtain more than one license (CPC 63108).

In **FR**: State monopoly on wholesale and retail sales of tobacco. Nationality requirement for tobacconists (buraliste) (part of CPC 6222, part of 6310).

**Measures:**

*ES: Law 14/2013 of 27 September 2014.*

*FR: Code général des impôts.*

With respect to Investment liberalisation – Market access, National treatment and Cross-border trade in services – Market access, National treatment:

In **AT**: Only natural persons may apply for an authorisation to operate as a tobacconist.

Priority is given to nationals of a Member State of the EEA (CPC 63108).

**Measures:**

*AT: Tobacco Monopoly Act 1996, § 5 and § 27.*

With respect to Investment liberalisation – Market Access and Cross-border trade in services – Market access, National treatment:

In **IT**: In order to distribute and sell tobacco, a licence is needed. The licence is granted through public procedures. The granting of licences is subject to an economic needs test. Main criteria: population and geographical density of existing selling points (part of CPC 6222, part of 6310).

**Measures:**

*IT: Legislative Decree 184/2003;*

*Law 165/1962;*

*Law 3/2003;*

*Law 1293/1957;*

*Law 907/1942; and*

*Decree of the President of the Republic (D.P.R.) 1074/1958.*



## Reservation No. 10 - Education services

<b>Sector – sub-sector:</b>	Education services (privately funded)
<b>Industry classification:</b>	CPC 921, 922, 923, 924
<b>Type of reservation:</b>	Market access National treatment Senior management and boards of directors Local presence
<b>Chapter:</b>	Investment liberalisation; Cross-border trade in services
<b>Level of government:</b>	EU/ Member State (unless otherwise specified)

### Description:

With respect to Investment liberalisation – Market access, National treatment, Senior management and boards of directors and Cross-border trade in services – Market access:

In **CY**: Nationality of a Member State is required for owners and majority shareholders in a privately funded school. Nationals of the United Kingdom may obtain authorisation from the Minister (of Education) in accordance with the specified form and conditions.

### Measures:

*CY: Private Schools Law of 2019 (N. 147(I)/2019)*

With respect to Investment liberalisation – Market access, National treatment and Cross-border trade in services – Market Access, National Treatment:

In **BG**: Privately funded primary and secondary education services may only be supplied by authorised Bulgarian enterprises (commercial presence is required). Bulgarian kindergartens and schools having foreign participation may be established or transformed at the request of associations, or corporations, or enterprises of Bulgarian and foreign natural or legal entities, duly registered in Bulgaria, by decision of the Council of Ministers on a motion by the Minister of Education and Science. Foreign owned kindergartens and schools may be established or transformed at the request of foreign legal entities in accordance with international agreements and conventions and under the provisions above. Foreign higher education institutions cannot establish subsidiaries in the territory of Bulgaria. Foreign higher education institutions may open faculties, departments, institutes and colleges in Bulgaria only within the structure of Bulgarian high schools and in cooperation with them (CPC 921, 922).

### Measures:

*BG: Pre-school and School Education Act; and*

*Law for the Higher Education, paragraph 4 of the additional provisions.*

With respect to Investment liberalisation – Market access, National treatment

In **SI**: Privately funded elementary schools may be founded by Slovenian natural or legal persons only. The service supplier must establish a registered office or branch office (CPC 921).

**Measures:**

**SI**: *Organisation and Financing of Education Act (Official Gazette of Republic of Slovenia, no. 12/1996) and its revisions, Article 40.*

With respect to Cross-border services – Local presence:

In **CZ** and **SK**: Establishment in a Member State is required to apply for state approval to operate as a privately funded higher education institution. This reservation does not apply to post-secondary technical and vocational education services (CPC 92310).

**Measures:**

**CZ**: *Act No. 111/1998, Coll. (Higher Education Act), § 39; and*

*Act No. 561/2004 Coll. on Pre-school, Basic, Secondary, Tertiary Professional and Other Education (the Education Act).*

**SK**: *Law No. 131 of 21 February 2002 on Universities.*

With respect to Investment liberalisation – Market Access and Cross-border services: Market access:

In **ES** and **IT**: An authorisation is required in order to open a privately funded university which issues recognised diplomas or degrees. An economic needs test is applied. Main criteria: population and density of existing establishments.

In **ES**: The procedure involves obtaining the advice of the Parliament.

In **IT**: This is based on a three-year programme and only Italian legal persons may be authorised to issue state-recognised diplomas (CPC 923).

**Measures:**

**ES**: *Ley Orgánica 6/2001, de 21 de Diciembre, de Universidades (Law 6 / 2001 of 21 December, on Universities), Article 4.*

**IT**: *Royal Decree 1592/1933 (Law on secondary education);*

*Law 243/1991 (Occasional public contribution for private universities);*

*Resolution 20/2003 of CNVSU (Comitato nazionale per la valutazione del sistema universitario); and*

*Decree of the President of the Republic (DPR) 25/1998.*

With respect to Investment liberalisation – Market access, National treatment, Senior management and boards of directors and Cross-border trade in services – Market access:

In **EL**: Nationality of a Member State is required for owners and a majority of the members of the board of directors in privately funded primary and secondary schools, and for teachers in privately

funded primary and secondary education (CPC 921, 922). Education at university level shall be provided exclusively by institutions which are fully self-governed public law legal persons. However, Law 3696/2008 permits the establishment by Union residents (natural or legal persons) of private tertiary education institutions granting certificates which are not recognised as being equivalent to university degrees (CPC 923).

**Measures:**

*EL: Laws 682/1977, 284/1968, 2545/1940, Presidential Degree 211/1994 as amended by*

*Presidential Degree 394/1997, Constitution of Hellas, Article 16, paragraph 5 and Law 3549/2007.*

With respect to Investment liberalisation – Market access and Cross-border trade in services – Market access:

In **AT**: The provision of privately funded university level education services in the area of applied sciences requires an authorisation from the competent authority, the AQ Austria (Agency for Quality Assurance and Accreditation Austria). An investor seeking to provide an applied science study programme must have his primary business being the supply of such programmes, and must submit a needs assessment and a market survey for the acceptance of the proposed study programme. The competent Ministry may deny an authorisation where the programme is determined to be incompatible with national educational interests. The applicant for a private university requires an authorisation from the competent authority (AQ Austria - Agency for Quality Assurance and Accreditation Austria). The competent Ministry may deny the approval if the decision of the accreditation authority does not comply with national educational interests (CPC 923).

**Measures:**

*AT: University of Applied Sciences Studies Act, BGBl. I Nr. 340/1993 as amended, § 2; Private*

*University Act, BGBl. I Nr. 74/2011 as amended, § 2; and*

*Act on Quality Assurance in Higher Education, BGBl. Nr. 74/2011 as amended, § 25 (3).*

With respect to Investment liberalisation – Market access, National treatment, Most-favoured nation treatment and Cross-border trade in services – Market access, National treatment:

In **FR**: Nationality of a Member State is required in order to teach in a privately funded educational institution (CPC 921, 922, 923). However, nationals of the United Kingdom may obtain an authorisation from the relevant competent authorities in order to teach in primary, secondary and higher level educational institutions. Nationals of the United Kingdom may also obtain an authorisation from the relevant competent authorities in order to establish and operate or manage primary, secondary or higher level educational institutions. Such authorisation is granted on a discretionary basis.

**Measures:**

*FR: Code de l'éducation.*

With respect to Investment – Market access, National treatment and Cross-border trade in services – Market access, National treatment:

In **MT**: Service suppliers seeking to provide privately funded higher or adult education services must obtain a licence from the Ministry of Education and Employment. The decision on whether to issue a licence may be discretionary (CPC 923, 924).

**Measures:**

**MT**: *Legal Notice 296 of 2012.*

## **Reservation No. 11 - Environmental services**

**Sector – sub-sector:** Environmental services – processing and recycling of used batteries and accumulators, old cars and waste from electrical and electronic equipment; protection of ambient air and climate cleaning services of exhaust gases

**Industry classification:** Part of CPC 9402, 9404

**Type of reservation:** Local presence

**Chapter:** Cross-border trade in services

**Level of government:** EU/ Member State (unless otherwise specified)

### **Description:**

In **SE**: Only entities established in Sweden or having their principal seat in Sweden are eligible for accreditation to perform control services of exhaust gas (CPC 9404).

In **SK**: For processing and recycling of used batteries and accumulators, waste oils, old cars and waste from electrical and electronic equipment, incorporation in the EEA is required (residency requirement) (part of CPC 9402).

### **Measures:**

**SE:** *The Vehicles Act (2002:574).*

**SK:** *Act 79/2015 on Waste.*

## Reservation No. 12 – Financial Services

<b>Sector – sub-sector:</b>	Financial services – insurance and banking
<b>Industry classification:</b>	<b>Not applicable</b>
<b>Type of reservation:</b>	Market access National treatment Most-favoured-nation treatment Senior management and boards of directors Local presence
<b>Chapter:</b>	Investment liberalisation; Cross-border trade in services
<b>Level of government:</b>	EU/ Member State (unless otherwise specified)

### Description:

#### **(a) Insurance and Insurance-related Services**

With respect to Investment liberalisation – Market access, National treatment and Cross-border trade in services – Market access, National treatment:

In **IT**: Access to the actuarial profession through natural persons only. Professional associations (no incorporation) among natural persons permitted. European Union nationality is required for the practice of the actuarial profession, except for foreign professionals who may be allowed to practice based on reciprocity.

#### **Measures:**

*IT*: Article 29 of the code of private insurance (Legislative decree no. 209 of 7 September 2005); and Law 194/1942, Article 4, Law 4/1999 on the register.

With respect to Investment liberalisation – Market access, National treatment and Cross-border trade in services – Local presence:

In **BG**: Pension insurance shall be carried out as a joint-stock company licensed in accordance with the Code of Social Insurance and registered under the Commerce Act or under the legislation of another Member State of the EU (no branches).

In **BG, ES, PL** and **PT**: Direct branching is not permitted for insurance intermediation, which is reserved to companies formed in accordance with the law of a Member State (local incorporation is required). For **PL**, residency requirement for insurance intermediaries

#### **Measures:**

*BG*: Insurance Code, articles 12, 56-63, 65, 66 and 80 paragraph 4, Social Insurance Code Art. 120a–162, Art. 209–253, Art. 260–310

**ES:** *Reglamento de Ordenación, Supervisión y Solvencia de Entidades Aseguradoras y Reaseguradoras (RD 1060/2015, de 20 de noviembre de 2015), article 36.*

**PL:** *Act on insurance and reinsurance activity of September 11, 2015 (Journal of Laws of 2020, item 895 and 1180); Act on insurance distribution of December 15, 2017 (Journal of Laws 2019, item 1881); Act on the organization and operation of pension funds of August 28, 1997 (Journal of Laws of 2020, item 105); Act of 6 March 2018 on rules regarding economic activity of foreign entrepreneurs and other foreign persons in the territory of the Republic of Poland*

**PT:** *Article 7 of Decree-Law 94-B/98 revoked by Decree-Law 2/2009, January 5th; and chapter I, Section VI of Decree-Law 94-B/98, articles 34, nr. 6, 7, and article 7 of Decree-Law 144/2006, revoked by Law 7/2019, January 16th. Article 8 of the legal regime governing the business of insurance and reinsurance distribution, approved by Law 7/2019, of January 16<sup>th</sup>.*

With respect to Investment liberalisation – National treatment:

In **AT:** The management of a branch office must consist of at least two natural persons resident in AT.

In **BG:** Residency requirement for the members of managing and supervisory body of (re)insurance undertakings and every person authorised to manage or represent the (re)insurance undertaking.

The Chairperson of the Management Board, the Chairperson of the Board of Directors, the Executive Director and the Managerial Agent of pension insurance companies must have a permanent address or hold a durable residence permit in Bulgaria.

**Measures:**

**AT:** *Insurance Supervision Act 2016, Article 14 para. 1 no. 3, Federal Law Gazette I No. 34/2015 (Versicherungsaufsichtsgesetz 2016, § 14 Abs. 1 Z 3, BGBl. I Nr. 34/2015)*

**BG:** *Insurance Code, articles 12, 56-63, 65, 66 and 80 paragraph 4,*

*Social Insurance Code, Art. 120a–162, Art. 209–253, Art. 260–310*

With respect to Investment liberalisation – Market access, National treatment:

In **BG:** Before establishing a branch or agency to provide insurance, a foreign insurer or reinsurer must have been authorised to operate in its country of origin in the same classes of insurance as those it wishes to provide in BG.

The income of the supplementary voluntary pension funds, as well as similar income directly connected with voluntary pension insurance, carried out by persons who are registered under the legislation of another Member State and who may, in compliance with the legislation concerned, perform voluntary pension insurance operations, shall not be taxable according to the procedure established by the Corporate Income Tax Act.

In **ES:** Before establishing a branch or agency in Spain in order to provide certain classes of insurance, a foreign insurer must have been authorised to operate in the same classes of insurance in its country of origin for at least five years.

In **PT**: In order to establish a branch or agency, foreign insurance undertakings must have been authorised to carry out the business of insurance or reinsurance, according to the relevant national law for at least five years.

**Measures:**

**BG**: Insurance Code, articles 12, 56-63, 65, 66 and 80 paragraph 4,

Social Insurance Code, Art. 120a–162, Art. 209–253, Art. 260–310

**ES**: Reglamento de Ordenación, Supervisión y Solvencia de Entidades Aseguradoras y Reaseguradoras (RD 1060/2015, de 20 de noviembre de 2015), article 36.

**PT**: Article 7 of Decree-Law 94-B/98 and chapter I, Section VI of Decree-Law 94-B/98, articles 34, nr. 6, 7, and article 7 of Decree-Law 144/2006; Article 215 of legal regime governing the taking up and pursuit of the business of insurance and reinsurance, approved by Law 147/2005, of September 9th.

With respect to Investment liberalisation – Market access:

In **AT**: In order to obtain a licence to open a branch office, foreign insurers must have a legal form corresponding or comparable to a joint stock company or a mutual insurance association in their home country.

In **EL**: Insurance and reinsurance undertakings with head offices in third countries may operate in Greece via establishing a subsidiary or a branch, where branch in this case does not take any specific legal form, as it means a permanent presence in the territory of a Member State (ie. Greece) of an undertaking with head office outside EU, which receives authorisation in that Member State (Greece) and which pursues insurance business.

**Measures:**

**AT**: Insurance Supervision Act 2016, Article 14 para. 1 no. 1, Federal Law Gazette I No. 34/2015 (Versicherungsaufsichtsgesetz 2016, § 14 Abs. 1 Z 1, BGBl. I Nr. 34/2015)

**EL**: Art. 130 of the Law 4364/ 2016 (Gov. Gazette 13/ A/ 05.02.2016)

With respect to Cross-border trade in services – National treatment, Local presence:

In **AT**: Promotional activity and intermediation on behalf of a subsidiary not established in the Union or of a branch not established in AT (except for reinsurance and retrocession) are prohibited.

In **DK**: No persons or companies (including insurance companies) may, for business purposes, assist in effecting direct insurance for persons resident in DK, for Danish ships or for property in DK, other than insurance companies licensed by Danish law or by Danish competent authorities.

In **SE**: The supply of direct insurance by a foreign insurer is allowed only through the mediation of an insurance service supplier authorised in Sweden, provided that the foreign insurer and the Swedish insurance company belong to the same group of companies or have an agreement of cooperation between them.

With respect to Cross-border trade in services – Local presence:



In **DE, HU** and **LT**: The supply of direct insurance services by insurance companies not incorporated in the European Union requires the setting up and authorisation of a branch.

In **SE**: The provision of insurance intermediation services by undertakings not incorporated in the EEA requires the establishment of a commercial presence (local presence requirement).

In **SK**: Air and maritime transport insurance, covering the aircraft/vessel and responsibility, can be underwritten only by insurance companies established in the Union or by the branch office of the insurance companies not established in the Union authorised in the Slovak Republic.

### **Measures**

**AT**: Insurance Supervision Act 2016, Article 13 para. 1 and 2, Federal Law Gazette I No. 34/2015 (*Versicherungsaufsichtsgesetz 2016, § 13 Abs. 1 und 2, BGBl. I Nr. 34/2015*) **DE**: §§67-69 *Versicherungsaufsichtsgesetz (VAG)* for all insurance services- implements Solvency 2; in connection with §105 *Luftverkehrs-Zulassungs-Ordnung (LuftVZO)* only for compulsory air liability insurance.

**DE**: *Versicherungsaufsichtsgesetz (VAG)* for all insurance services; in connection with *Luftverkehrs-Zulassungs-Ordnung (LuftVZO)* only for compulsory air liability insurance

**DK**: *Lov om finansiel virksomhed jf. lovbekendtgørelse 182 af 18. februar 2015.*

**HU**: Act LX of 2003 **LT**: Law on Insurance, 18 of September, 2003 m. Nr. IX-1737, last amendment 13 of June 2019 Nr. XIII-2232.

**SE**: *Lag om försäkringsförmedling (Insurance Distribution Mediation Act) (Chapter 3, section 3, 2018:12192005:405); and Foreign Insurers Business in Sweden Act (Chapter 4, section 1 and 10, 1998:293).*

**SK**: Act 39/2015 on insurance

### **(b) Banking and other financial services**

With respect to Investment liberalisation – Market Access, National treatment, and Cross-border trade in services – Local presence:

In **BG**: For pursuing the activities of lending with funds which are not raised through taking of deposits or other repayable funds, acquiring holdings in a credit institution or another financial institution, financial leasing, guarantee transactions, acquisition of claims on loans and other forms of financing (factoring, forfeiting, etc.), non-bank financial institutions are subject to registration regime with the Bulgarian National Bank. The financial institution shall have its main business in the territory of Bulgaria.

In **BG**: Non-EEA banks may pursue banking activity in Bulgaria after obtaining a license from BNB for taking up and pursuing of business activities in the Republic of Bulgaria through a branch.

In **IT**: In order to be authorised to operate the securities settlement system or to provide central securities depository services with an establishment in Italy, a company is required to be incorporated in Italy (no branches).

In the case of collective investment schemes other than undertakings for collective investment in transferable securities ("UCITS") harmonised under EU legislation, the trustee or depository is required to be established in Italy or in another Member State and have a branch in Italy.

Management enterprises of investment funds not harmonised under Union legislation are also required to be incorporated in Italy (no branches).

Only banks, insurance enterprises, investment firms and enterprises managing UCITS harmonised under EU legislation having their legal head office in the Union, as well as UCITS incorporated in Italy, may carry out the activity of pension fund resource management.

In providing the activity of door-to-door selling, intermediaries must utilise authorised financial salesmen resident within the territory of a Member State.

Representative offices of non-European Union intermediaries cannot carry out activities aimed at providing investment services, including trading for own account and for the account of customers, placement and underwriting financial instruments (branch required).

In **PT**: Pension fund management may be provided only by specialised companies incorporated in PT for that purpose and by insurance companies established in PT and authorised to take up life insurance business, or by entities authorised to provide pension fund management in other Member States. Direct branching from non-European Union countries is not permitted.

**Measures:**

**BG:** *Law on Credit Institutions, article 2, paragraph 5, article 3a and article 17*

*Code Of Social Insurance, articles 121, 121b, 121f; and*

*Currency Law, article 3.*

**IT:** *Legislative Decree 58/1998, articles 1, 19, 28, 30-33, 38, 69 and 80;*

*Joint Regulation of Bank of Italy and Consob 22.2.1998, articles 3 and 41;*

*Regulation of Bank of Italy 25.1.2005;*

*Title V, Chapter VII, Section II, Consob Regulation 16190 of 29.10.2007, articles 17-21, 78-81, 91-111; and subject to:*

*Regulation (EU) No 909/2014 of the European Parliament and of the Council of 23 July 2014 on improving securities settlement in the European Union and on central*

**PT:** *Decree-Law 12/2006, as amended by Decree-Law 180/2007 Decree-Law 357-A/2007, Regulation 7/2007-R, as amended by Regulation 2/2008-R, Regulation 19/2008-R, Regulation 8/2009. Article 3 of the legal regime governing the establishment and functioning of pension funds and their management entities approved by Law 27/2020, of July 23rd.*

With respect to Investment liberalisation – Market Access, National treatment:

In **HU**: Branches of non-EEA investment fund management companies may not engage in the management of European investment funds and may not provide asset management services to private pension funds.

**Measures:**

**HU**: Act CCXXXVII of 2013 on Credit Institutions and Financial Enterprises;

Act CCXXXVII of 2013 on Credit Institutions and Financial Enterprises; and

Act CXX of 2001 on the Capital Market.

With respect to Investment liberalisation – National Treatment and Cross-border trade in services – Market Access:

In **BG**: A bank shall be managed and represented jointly by at least two persons. The persons who manage and represent the bank shall be personally present at its management address. Legal persons may not be elected members of the managing board or the board of directors of a bank.

In **SE**: A founder of a savings bank shall be a natural person.

**Measures:**

**BG**: Law on Credit Institutions, article 10;

Code Of Social Insurance, article 121e; and

Currency Law, article 3.

**SE**: Sparbankslagen (Savings Bank Act) (1987:619), Chapter 2, § 1.

With respect to Investment liberalisation – National treatment:

In **HU**: The board of directors of a credit institution shall have at least two members recognised as resident according to foreign exchange regulations and having had prior permanent residence in HU for at least one year.

**Measures:**

**HU**: Act CCXXXVII of 2013 on Credit Institutions and Financial Enterprises;

Act CCXXXVII of 2013 on Credit Institutions and Financial Enterprises; and

Act CXX of 2001 on the Capital Market.

With respect to Investment liberalisation – Market Access:

In **RO**: Market operators are legal persons set up as joint stock companies according to the provisions of the Company law. Alternative trading systems (Multilateral trading facility (MTF) pursuant to MiFID II Directive) can be managed by a system operator set up under the conditions described above or by an investment firm authorised by ASF (Autoritatea de Supraveghere Financiară – Financial Supervisory Authority).

In **SI**: A pension scheme may be provided by a mutual pension fund (which is not a legal entity and is therefore managed by an insurance company, a bank or a pension company), a pension company or an insurance company. Additionally, a pension scheme can also be offered by pension scheme providers established in accordance with the regulations applicable in a Member State of the EU.

**Measures:**

**RO**: Law no. 126 of 11 June 2018 regarding financial instruments and Regulation no. 1/2017 for the amendment and supplement of Regulation no. 2/2006 on regulated markets and alternative trading systems, approved by Order of NSC no. 15/2006 - ASF – Autoritatea de Supraveghere Financiară – Financial Supervisory Authority. **SI**: Pension and Disability Insurance Act, (Official Gazette no. 102/2015 (as last amended No 28/19)).

With respect to Cross-border trade in services – Local presence:

In **HU**: Non-EEA companies may provide financial services or engage in activities auxiliary to financial services solely through a branch in HU.

**Measures:**

**HU**: Act CCXXXVII of 2013 on Credit Institutions and Financial Enterprises;

Act CCXXXVII of 2013 on Credit Institutions and Financial Enterprises; and

Act CXX of 2001 on the Capital Market.

## Reservation No. 13 - Health services and social services

<b>Sector – sub-sector:</b>	Health services and social services
<b>Industry classification:</b>	CPC 931, 933
<b>Type of reservation:</b>	Market access National treatment
<b>Chapter:</b>	Investment liberalisation; Cross-border trade in services
<b>Level of government:</b>	EU/ Member State (unless otherwise specified)

### Description:

#### With respect to Investment liberalisation – Market access:

In **DE** (applies also to the regional level of government): Rescue services and "qualified ambulance services" are organised and regulated by the Länder. Most Länder delegate competences in the field of rescue services to municipalities. Municipalities are allowed to give priority to not-for-profit operators. This applies equally to foreign as well as domestic service suppliers (CPC 931, 933). Ambulance services are subject to planning, permission and accreditation. Regarding telemedicine, the number of ICT (information and communications technology) service suppliers may be limited to guarantee interoperability, compatibility and necessary safety standards. This is applied in a non-discriminatory way.

In **HR**: Establishment of some privately funded social care facilities may be subject to needs based limits in particular geographical areas (CPC 9311, 93192, 93193, 933).

In **SI**: a state monopoly is reserved for the following services: Supply of blood, blood preparations, removal and preservation of human organs for transplant, socio-medical, hygiene, epidemiological and health-ecological services, patho-anatomical services, and biomedically-assisted procreation (CPC 931).

### **Measures:**

**DE:** *Bundesärzteordnung (BÄO; Federal Medical Regulation):*

*Gesetz über die Ausübung der Zahnheilkunde (ZHG);*

*Gesetz über den Beruf der Psychotherapeutin und des Psychotherapeuten (PsychThG; Act on the Provision of Psychotherapy Services);*

*Gesetz über die berufsmäßige Ausübung der Heilkunde ohne Bestallung (Heilpraktikergesetz);*

*Gesetz über das Studium und den Beruf der Hebammen (HebG);*

*Gesetz über den Beruf der Notfallsanitäterin und des Notfallsanitäters (NotSanG);*

*Gesetz über die Pflegeberufe (PfIBG);*

*Gesetz über die Berufe in der Physiotherapie (MPhG);*

*Gesetz über den Beruf des Logopäden (LogopG);*

*Gesetz über den Beruf des Orthoptisten und der Orthoptistin (OrthoptG);*

*Gesetz über den Beruf der Podologin und des Podologen (PodG);*

*Gesetz über den Beruf der Diätassistentin und des Diätassistenten (DiätAssG);*

*Gesetz über den Beruf der Ergotherapeutin und des Ergotherapeuten (ErgThg);  
Bundesapothekerordnung (BapO);*

*Gesetz über den Beruf des pharmazeutisch-technischen Assistenten (PTAG);*

*Gesetz über technische Assistenten in der Medizin (MTAG);*

*Gesetz zur wirtschaftlichen Sicherung der Krankenhäuser und zur Regelung der  
Krankenhauspflegesätze (Krankenhausfinanzierungsgesetz - KHG);*

*Gewerbeordnung (German Trade, Commerce and Industry Regulation Act);*

*Sozialgesetzbuch Fünftes Buch (SGB V; Social Code, Book Five) - Statutory Health Insurance;*

*Sozialgesetzbuch Sechstes Buch (SGB VI; Social Code, Book Six) - Statutory Pension Insurance;*

*Sozialgesetzbuch Siebtes Buch (SGB VII; Social Code, Book Seven) - Statutory Accident Insurance;*

*Sozialgesetzbuch Neuntes Buch (SGB IX; Social Code, Book Nine) - Rehabilitation and Participation of  
Persons with Disabilities;*

*Sozialgesetzbuch Elftes Buch (SGB XI; Social Code, Book Eleven) - Social Assistance.*

*Personenbeförderungsgesetz (PBefG; Act on Public Transport).*

*Regional level:*

*Gesetz über den Rettungsdienst (Rettungsdienstgesetz - RDG) in Baden-Württemberg;*

*Bayerisches Rettungsdienstgesetz (BayRDG);*

*Gesetz über den Rettungsdienst für das Land Berlin (Rettungsdienstgesetz);*

*Gesetz über den Rettungsdienst im Land Brandenburg (BbgRettG);*

*Bremisches Hilfeleistungsgesetz (BremHilfeG);*

*Hamburgisches Rettungsdienstgesetz (HmbRDG);*

*Gesetz über den Rettungsdienst für das Land Mecklenburg-Vorpommern (RDGM-V);*

*Niedersächsisches Rettungsdienstgesetz (NRettDG);*

*Gesetz über den Rettungsdienst sowie die Notfallrettung und den Krankentransport durch Unternehmer (RettG NRW);*

*Landesgesetz über den Rettungsdienst sowie den Notfall- und Krankentransport (RettdG);*

*Saarländisches Rettungsdienstgesetz (SRettG);*

*Sächsisches Gesetz über den Brandschutz, Rettungsdienst und Katastrophenschutz (SächsBRKG);*

*Rettungsdienstgesetz des Landes Sachsen-Anhalt (RettdG LSA);*

*Schleswig-Holsteinisches Rettungsdienstgesetz (SHRDG);*

*Thüringer Rettungsdienstgesetz (ThüRettG).*

*Landespflegegesetze:*

*Gesetz zur Umsetzung der Pflegeversicherung in Baden-Württemberg (Landespflegegesetz - LPfVG);*

*Gesetz zur Ausführung der Sozialgesetze (AGSG);*

*Gesetz zur Planung und Finanzierung von Pflegeeinrichtungen (Landespflegeeinrichtungsgesetz - LPflegEG);*

*Gesetz über die pflegerische Versorgung im Land Brandenburg (Landespflegegesetz - LPflegeG);*

*Gesetz zur Ausführung des Pflege-Versicherungsgesetzes im Lande Bremen und zur Änderung des Bremischen Ausführungsgesetzes zum Bundessozialhilfegesetz (BremAGPflegeVG);*

*Hamburgisches Landespflegegesetz (HmbLPfG);*

*Hessisches Ausführungsgesetz zum Pflege-Versicherungsgesetz;*

*Landespflegegesetz (LPflegeG M-V);*

*Gesetz zur Planung und Förderung von Pflegeeinrichtungen nach dem Elften Buch Sozialgesetzbuch (Niedersächsisches Pflegegesetz - NPflegeG);*

*Gesetz zur Weiterentwicklung des Landespflegerechts und Sicherung einer unterstützenden Infrastruktur für ältere Menschen, pflegebedürftige Menschen und deren Angehörige (Alten- und Pflegegesetz Nordrhein-Westfalen – APG NRW);*

*Landesgesetz zur Sicherstellung und Weiterentwicklung der pflegerischen Angebotsstruktur (LPflegeASG) (Rheinland-Pfalz);*

*Gesetz Nr. 1694 zur Planung und Förderung von Angeboten für hilfe-, betreuungs- oder pflegebedürftige Menschen im Saarland (Saarländisches Pflegegesetz);*

*Sächsisches Pflegegesetz (SächsPflegeG);*

*Schleswig-Holstein: Ausführungsgesetz zum Pflege-Versicherungsgesetz (Landespflegegesetz - LPflegeG);*

*Thüringer Gesetz zur Ausführung des Pflege-Versicherungsgesetzes (ThürAGPflegeVG).*

*Landeskrankenhausgesetz Baden-Württemberg;*

*Bayerisches Krankenhausgesetz (BayKrG);*

*Berliner Gesetz zur Neuregelung des Krankenhausrechts;*

*Krankenhausentwicklungsgesetz Brandenburg (BbgKHEG);*

*Bremisches Krankenhausgesetz (BrmKrHG);*

*Hamburgisches Krankenhausgesetz (HmbKHG);*

*Hessisches Krankenhausgesetz 2011 (HKHG 2011);*

*Krankenhausgesetz für das Land Mecklenburg-Vorpommern (LKHG M-V);*

*Niedersächsisches Krankenhausgesetz (NKHG);*

*Krankenhausgestaltungsgesetz des Landes Nordrhein-Westfalen (KHGG NRW);*

*Landeskrankenhausgesetz Rheinland-Pfalz (LKG Rh-Pf);*

*Saarländisches Krankenhausgesetz (SKHG);*

*Gesetz zur Neuordnung des Krankenhauswesens (Sächsisches Krankenhausgesetz - SächsKHG);*

*Krankenhausgesetz Sachsen-Anhalt (KHG LSA);*

*Gesetz zur Ausführung des Krankenhausfinanzierungsgesetzes (AG-KHG) in Schleswig-Holstein;*

*Thüringisches Krankenhausgesetz (Thür KHG).*

**HR:** Health Care Act (OG 150/08, 71/10, 139/10, 22/11, 84/11, 12/12, 70/12, 144/12).

**SI:** Law of Health Services, Official Gazette of the RS, No. 23/2005, Articles 1, 3 and 62-64; Infertility Treatment and Procedures of the Biomedically-Assisted Procreation Act, Official Gazette of the RS, No. 70/00, Articles 15 and 16; and

Supply of Blood Act (ZPKrv-1), Official Gazette of RS, no. 104/06, Articles 5 and 8.

With respect to Investment liberalisation – Market access, National treatment:



In **FR**: For hospital and ambulance services, residential health facilities (other than hospital services) and social services, an authorisation is necessary in order to exercise management functions. The authorisation process takes into account the availability of local managers. Companies can take any legal forms, except those reserved to liberal professions.

**Measures:**

**FR:** *Loi 90-1258 relative à l'exercice sous forme de société des professions libérales, Loi n°2011-940 du 10 août 2011 modifiant certaines dispositions de la loi n°2009-879 dite HPST, Loi n°47-1775 portant statut de la coopération; and Code de la santé publique.*

## **Reservation No. 14 - Tourism and travel related services**

<b>Sector – sub-sector:</b>	Tourism and travel related services - hotels, restaurants and catering; travel agencies and tour operators services (including tour managers); tourist guides services
<b>Industry classification:</b>	CPC 641, 642, 643, 7471, 7472
<b>Type of reservation:</b>	Market access National treatment Senior management and boards of directors Local presence
<b>Chapter:</b>	Investment liberalisation; Cross-border trade in services
<b>Level of government:</b>	EU/ Member State (unless otherwise specified)

### **Description:**

With respect to Investment liberalisation – Market Access, National Treatment, Senior Management and Boards of Directors and Cross-border trade in services – Market Access, National Treatment:

In **BG**: Incorporation (no branches) is required. Tour operation or travel agency services may be provided by a person established in the EEA if, upon establishment in the territory of Bulgaria, the said person presents a copy of a document certifying the right thereof to practice that activity and a certificate or another document issued by a credit institution or an insurer containing data of the existence of insurance covering the liability of the said person for damage which may ensue as a result of a culpable non-fulfilment of professional duties. The number of foreign managers may not exceed the number of managers who are Bulgarian nationals, in cases where the public (state or municipal) share in the equity capital of a Bulgarian company exceeds 50 per cent. EEA nationality requirement for tourist guides (CPC 641, 642, 643, 7471, 7472).

### **Measures:**

**BG:** *Law for Tourism, Articles 61, 113 and 146.*

With respect to Investment liberalisation – Market access, National treatment and Cross-border trade in services – Market access, National treatment, Local presence:

In **CY**: A licence to establish and operate a tourism and travel company or agency, as well as the renewal of an operating licence of an existing company or agency, shall be granted only to European Union natural or legal persons. No non-resident company except those established in another Member State, can provide in the Republic of Cyprus, on an organised or permanent basis, the activities referred to under Article 3 of the abovementioned Law, unless represented by a resident company. The provision of tourist guide services and travel agencies and tour operators services requires nationality of a Member State (CPC 7471, 7472).

### **Measures:**

**CY:** *The Tourism and Travel Offices and Tourist Guides Law 1995 (Law 41(I)/1995) as amended.*

With respect to Investment liberalisation – Market Access, National Treatment, Most-Favoured Nation Treatment and Cross-border trade in services – Market Access, National Treatment, Most-Favoured Nation Treatment:

In **EL**: Third-country nationals have to obtain a diploma from the Tourist Guide Schools of the Greek Ministry of Tourism, in order to be entitled to the right of practicing the profession. By exception, the right of practicing the profession can be temporarily (up to one year) accorded to third-country nationals under certain explicitly defined conditions, by way of derogation of the above mentioned provisions, in the event of the confirmed absence of a tourist guide for a specific language.

***With respect to Investment liberalisation – Market Access, National Treatment and Cross-border trade in services – Market Access, National Treatment,:***

In **ES** (for ES applies also to the regional level of government): Nationality of a Member State is required for the provision of tourist guide services (CPC 7472).

In **HR**: EEA nationality is required for hospitality and catering services in households and rural homesteads (CPC 641, 642, 643, 7471, 7472).

**Measures:**

**EL**: Presidential Degree 38/2010, Ministerial Decision 165261/IA/2010 (Gov. Gazette 2157/B), Article 50 of the law 4403/2016, Article 47 of the law 4582/2018 (Gov. Gazette 208/A). **ES**: Andalucía: Decreto 8/2015, de 20 de enero, Regulador de guías de turismo de Andalucía;

Aragón: Decreto 21/2015, de 24 de febrero, Reglamento de Guías de turismo de Aragón;

Cantabria: Decreto 51/2001, de 24 de julio, Article 4, por el que se modifica el Decreto 32/1997, de 25 de abril, por el que se aprueba el reglamento para el ejercicio de actividades turísticoinformativas privadas;

Castilla y León: Decreto 25/2000, de 10 de febrero, por el que se modifica el Decreto 101/1995, de 25 de mayo, por el que se regula la profesión de guía de turismo de la Comunidad Autónoma de Castilla y León;

Castilla la Mancha: Decreto 86/2006, de 17 de julio, de Ordenación de las Profesiones Turísticas;

Cataluña: Decreto Legislativo 3/2010, de 5 de octubre, para la adecuación de normas con rango de ley a la Directiva 2006/123/CE, del Parlamento y del Consejo, de 12 de diciembre de 2006, relativa a los servicios en el mercado interior, Article 88;

Comunidad de Madrid: Decreto 84/2006, de 26 de octubre del Consejo de Gobierno, por el que se modifica el Decreto 47/1996, de 28 de marzo;

Comunidad Valenciana: Decreto 90/2010, de 21 de mayo, del Consell, por el que se modifica el reglamento regulador de la profesión de guía de turismo en el ámbito territorial de la Comunitat Valenciana, aprobado por el Decreto 62/1996, de 25 de marzo, del Consell;

Extremadura: Decreto 37/2015, de 17 de marzo;

Galicia: Decreto 42/2001, de 1 de febrero, de Refundición en materia de agencias de viajes, guías de turismo y turismo activo;

*Illes Balears: Decreto 136/2000, de 22 de septiembre, por el cual se modifica el Decreto 112/1996, de 21 de junio, por el que se regula la habilitación de guía turístico en las Islas Baleares; Islas Canarias: Decreto 13/2010, de 11 de febrero, por el que se regula el acceso y ejercicio de la profesión de guía de turismo en la Comunidad Autónoma de Canarias, Article 5;*

*La Rioja: Decreto 14/2001, de 4 de marzo, Reglamento de desarrollo de la Ley de Turismo de La Rioja;*

*Navarra: Decreto Foral 288/2004, de 23 de agosto. Reglamento para actividad de empresas de turismo activo y cultural de Navarra.*

*Principado de Asturias: Decreto 59/2007, de 24 de mayo, por el que se aprueba el Reglamento regulador de la profesión de Guía de Turismo en el Principado de Asturias; and*

*Región de Murcia: Decreto n.º 37/2011, de 8 de abril, por el que se modifican diversos decretos en materia de turismo para su adaptación a la ley 11/1997, de 12 de diciembre, de turismo de la Región de Murcia tras su modificación por la ley 12/2009, de 11 de diciembre, por la que se modifican diversas leyes para su adaptación a la directiva 2006/123/CE, del Parlamento Europeo y del Consejo de 12 de diciembre de 2006, relativa a los servicios en el mercado interior.*

**HR:** *Hospitality and Catering Industry Act (OG 138/06, 152/08, 43/09, 88/10 i 50/12); and Act on Provision of Tourism Services (OG No. 68/07 and 88/10).*

With respect to Investment liberalisation – National Treatment and Cross-border trade in services – Market Access, National Treatment:

In **HU:** The supply of travel agent and tour operator services, and tourist guide services on a cross-border basis is subject to a licence issued by the Hungarian Trade Licensing Office. Licences are reserved to EEA nationals and legal persons having their seats in the EEA (CPC 7471, 7472).

In **IT** (applies also to the regional level of government): tourist guides from non-European Union countries need to obtain a specific licence from the region in order to act as a professional tourist guide. Tourist guides from Member States can work freely without the requirement for such a licence. The licence is granted to tourist guides demonstrating adequate competence and knowledge (CPC 7472).

**Measures:**

**HU:** *Act CLXIV of 2005 on Trade, Government Decree No. 213/1996 (XII.23.) on Travel Organisation and Agency Activities.*

**IT:** *Law 135/2001 Articles 7.5 and 6; and Law 40/2007 (DL 7/2007).*

## Reservation No. 15 - Recreational, cultural and sporting services

<b>Sector – sub-sector:</b>	Recreational services; other sporting services
<b>Industry classification:</b>	CPC 962, part of 96419
<b>Type of reservation:</b>	Market access National treatment Senior management and boards of directors
<b>Chapter:</b>	Investment liberalisation; Cross-border trade in services
<b>Level of government:</b>	EU/ Member State (unless otherwise specified)

### Description:

#### ***Other sporting services (CPC 96419)***

With respect to Investment liberalisation – National treatment, Senior management and boards of directors and Cross-border trade in services –National treatment:

In **AT** (applies to the regional level of government): The operation of ski schools and mountain guide services is governed by the laws of the Bundesländer. The provision of these services may require nationality of a Member State of the EEA. Enterprises may be required to appoint a managing director who is a national of a Member State of the EEA.

With respect to Investment liberalisation – National treatment and Cross-border trade in services – National treatment:

In **CY**: Nationality requirement for the establishment of a dance school and nationality requirement for physical instructors.

#### **Measures:**

**AT:** *Kärntner Schischulgesetz, LGBL. Nr. 53/97;*

*Kärntner Berg- und Schiführergesetz, LGBL. Nr. 25/98;*

*NÖ- Sportgesetz, LGBL. Nr. 5710;*

*OÖ- Sportgesetz, LGBL. Nr. 93/1997;*

*Salzburger Schischul- und Snowboardschulgesetz, LGBL. Nr. 83/89;*

*Salzburger Bergführergesetz, LGBL. Nr. 76/81;*

*Steiermärkisches Schischulgesetz, LGBL. Nr.58/97;*

*Steiermärkisches Berg- und Schiführergesetz, LGBL. Nr. 53/76;*

*Tiroler Schischulgesetz. LGBL. Nr. 15/95;*

*Tiroler Bergsportführergesetz, LGBL. Nr. 7/98;*

*Vorarlberger Schischulgesetz, LGBL. Nr. 55/02 §4 (2)a;*

*Vorarlberger Bergführergesetz, LGBL. Nr. 54/02; and*

*Wien: Gesetz über die Unterweisung in Wintersportarten, LGBL. Nr. 37/02.*

**CY:** *Law 65(I)/1997 as amended; and*

*Law 17(I) /1995 as amended.*

## Reservation No. 16 - Transport services and services auxiliary to transport services

<b>Sector – sub-sector:</b>	Transport services - fishing and water transportation – any other commercial activity undertaken from a ship; water transportation and auxiliary services for water transport; rail transport and auxiliary services to rail transport; road transport and services auxiliary to road transport; services auxiliary to air transport services
<b>Industry classification:</b>	ISIC Rev. 3.1 0501, 0502; CPC 5133, 5223, 711, 712, 721, 741, 742, 743, 744, 745, 748, 749, 7461, 7469, 83103, 86751, 86754, 8730, 882
<b>Type of reservation:</b>	Market access National treatment Most-favoured-nation treatment Senior management and boards of directors Local presence
<b>Chapter:</b>	Investment liberalisation; Cross-border trade in services
<b>Level of government:</b>	EU/ Member State (unless otherwise specified)

### Description:

*(a) Maritime transport and auxiliary services for maritime transport. Any commercial activity undertaken from a ship (ISIC Rev. 3.1 0501, 0502; CPC 5133, 5223, 721, Part of 742, 745, 74540, 74520, 74590, 882)*

With respect to Investment liberalisation – Market Access, and Cross-border trade in services – Market Access:

In **EU**: For port services, the managing body of a port, or the competent authority, may limit the number of providers of port services for a given port service.

### Measures:

**EU**: Regulation (EU) 2017/352 of 15 February 2017 establishing a framework for the provision of port services and common rules on the financial transparency of ports, Article 6.

With respect to Investment liberalisation – Market access, National treatment, Senior management and boards of directors; Cross-border trade in services – Market access, National treatment:

In **BG**: The carriage and any activities related to hydraulic-engineering and underwater technical works, prospecting and extraction of mineral and other inorganic resources, pilotage, bunkering, receipt of waste, water-and-oil mixtures and other such, performed by vessels in the internal waters, and the territorial sea of Bulgaria, may only be performed by vessels flying the Bulgarian flag or vessels flying the flag of another Member State.

The number of the service suppliers at the ports may be limited depending on the objective capacity of the port, which is decided by an expert commission, set up by the Minister of Transport, Information Technology and Communications.

Nationality requirement for supporting services. The master and the chief engineer of the vessel shall mandatorily be nationals of a Member State of the EEA, or of the Swiss Confederation. (ISIC Rev. 3.1 0501, 0502, CPC 5133, 5223, 721, 74520, 74540, 74590, 882).

**Measures:**

**BG:** *Merchant Shipping Code; Law For the Sea Water, Inland Waterways and Ports of the Republic of Bulgaria; Ordinance for the condition and order for selection of Bulgarian carriers for carriage of passengers and cargoes under international treaties; and Ordinance 3 for servicing of unmanned vessels.*

With respect to Investment liberalisation – Market Access and Cross-border trade in services – Market Access:

In **BG:** Regarding supporting services for public transport carried out in Bulgarian ports, in ports having national significance, the right to perform supporting activities is granted through a concession contract. In ports having regional significance, this right is granted by a contract with the owner of the port (CPC 74520, 74540, 74590).

**Measures:**

**BG:** *Merchant Shipping Code; Law For the Sea Water, Inland Waterways and Ports of the Republic of Bulgaria.*

With respect to Cross-border trade in services – Local presence:

In **DK:** Pilotage-providers may only conduct pilotage service in Denmark, if they are domiciled in the EEA and registered and approved by the Danish Authorities in accordance with the Danish Act on Pilotage (CPC 74520).

**Measures:**

**DK:** *Danish Pilotage Act, §18.*

With respect to Investment liberalisation - Market access, National treatment, Most-Favoured nation treatment and Cross-border trade in services - Market access, National treatment, Most-favoured-nation treatment:

In **DE** (applies also to the regional level of government): A vessel that does not belong to a national of a Member State may only be used for activities other than transport and auxiliary services in the German federal waterways after specific authorisation. Waivers for non- European Union vessels may only be granted if no European Union vessels are available or if they are available under very unfavourable conditions, or on the basis of reciprocity. Waivers for vessels flying under the United Kingdom flag may be granted on the basis of reciprocity (§ 2 paragraph 3 KüSchVO). All activities falling within the scope of the pilot law are regulated and accreditation is restricted to nationals of the EEA or the Swiss Confederation. Provision and Operation of facilities for pilotage is restricted to public authorities or companies, which are designated by them.

For rental or leasing of seagoing vessels with or without operators, and for rental or leasing without operator of non-seagoing vessels, the conclusion of contracts for freight transport by ships flying a foreign flag or the chartering of such vessels may be restricted, depending on the availability of ships flying under the German flag or the flag of another Member State.



Transactions between residents and non-residents concerning:

- (i) rental of inland waterway transport vessels, which are not registered in the economic area;
- (ii) transport of freight with such inland waterway transport vessels; or
- (iii) towing services by such inland waterway transport vessels,

within the economic area may be restricted (Water transport, Supporting services for water transport, Rental of ships, Leasing services of ships without operators (CPC 721, 745, 83103, 86751, 86754, 8730)).

**Measures:**

*DE: Gesetz über das Flaggenrecht der Seeschiffe und die Flaggenführung der Binnenschiffe (Flaggenrechtsgesetz; Flag Protection Act);*

*Verordnung über die Küstenschifffahrt (KüSchV);*

*Gesetz über die Aufgaben des Bundes auf dem Gebiet der Binnenschifffahrt (Binnenschifffahrtsgesetz - BinSchAufgG);*

*Verordnung über Befähigungszeugnisse in der Binnenschifffahrt (Binnenschifferpatentverordnung - BinSchPatentV);*

*Gesetz über das Seelotswesen (Seelotsgesetz - SeeLG);*

*Gesetz über die Aufgaben des Bundes auf dem Gebiet der Seeschifffahrt (Seeaufgabengesetz - SeeAufgG); and*

*Verordnung zur Eigensicherung von Seeschiffen zur Abwehr äußerer Gefahren (See-Eigensicherungsverordnung - SeeEigensichV). r*

With respect to Investment liberalisation - Market access, National Treatment and Cross-border trade in services - Market access, National treatment:

In **FI**: supporting services for maritime transport when provided in Finnish maritime waters are reserved to fleets operating under the national, Union or Norwegian flag (CPC 745).

**Measures:**

*FI: Merilaki (Maritime Act) (674/1994); and*

*Laki elinkeinon harjoittamisen oikeudesta (Act on the Right to Carry on a Trade) (122/1919), s. 4.*

With respect to Investment liberalisation - Market access:

In **EL**: Public monopoly imposed in port areas for cargo handling services (CPC 741).

In **IT**: An economic needs test is applied for maritime cargo-handling services. Main criteria: number of and impact on existing establishments, population density, geographic spread and creation of new employment (CPC 741).

**Measures:**

*EL: Code of Public Maritime Law (Legislative Decree 187/1973).*

*IT: Shipping Code;*

*Law 84/1994; and*

*Ministerial decree 585/1995.*

**(b) Rail transport and auxiliary services to rail transport (CPC 711, 743)**

With respect to Investment liberalisation - Market access, National treatment, and Cross-border trade in services - Market access, National treatment:

In **BG**: Only nationals of a Member State may provide rail transport or supporting services for rail transport in Bulgaria. A licence to carry out passenger or freight transportation by rail is issued by the Minister of Transport to railway operators registered as traders (CPC 711, 743).

**Measures:**

*BG: Law for Railway Transport, Articles. 37, 48.*

With respect to Investment liberalisation - Market access:

In **LT**: The exclusive rights for the provision of transit services are granted to railway undertakings which are owned, or whose stock is 100 per cent owned, by the state (CPC 711).

**Measures:**

*LT: Railway transport Code of the Republic of Lithuania of 22 April 2004 No. IX-2152 as amended by 8 June 2006 No. X-653.*

**(c) Road transport and services auxiliary to road transport (CPC 712, 7121, 7122, 71222, 7123)**

For road transport services not covered by Titles I [Transport of goods by road] and II [Transport of passengers by Road] of Heading Three [Road Transport] of Part Two [Trade, transport and fisheries] and Annex ROAD-1[Transport of goods by road].

With respect to Investment liberalisation - Market access, National treatment, and Cross-border trade in services - Market access, National treatment:

In **AT**: (With respect also to Most-favoured-nation treatment) For passenger and freight transportation, exclusive rights or authorisations may only be granted to nationals of the Contracting Parties of the EEA and to legal persons of the Union having their headquarters in Austria. Licences are granted on non-discriminatory terms, under condition of reciprocity (CPC 712).

**Measures:**

*AT: Güterbeförderungsgesetz (Goods Transportation Act), BGBl. Nr. 593/1995; § 5;*

*Gelegenheitsverkehrsgesetz (Occasional Traffic Act), BGBl. Nr. 112/1996; § 6; and*

*Kraftfahrliniengesetz (Law on Scheduled Transport), BGBl. I Nr. 203/1999 as amended, §§ 7 and 8.*

With respect to Investment liberalisation - National treatment, Most-favoured-nation treatment:

In **EL**: For operators of road freight transport services. In order to engage in the occupation of road freight transport operator a Hellenic licence is needed. Licences are granted on non-discriminatory terms, under condition of reciprocity (CPC 7123).

**Measures:**

*EL: Licensing of road freight transport operators: Greek law 3887/2010 (Government Gazette*

*A' 174), as amended by Article 5 of law 4038/2012 (Government Gazette A' 14)*

With respect to Investment liberalisation - Market access:

In **IE**: Economic needs test for intercity bussing services. Main criteria: number of and impact on existing establishments, population density, geographical spread, impact on traffic conditions and creation of new employment (CPC 7121, CPC 7122).

In **MT**: Taxis - numerical restrictions on the number of licences apply.

Karozzini (horse drawn carriages): Numerical Restrictions on the number of licences apply (CPC 712).

In **PT**: Economic needs test for limousine services. Main criteria: number of and impact on existing establishments, population density, geographic spread, impact on traffic conditions and creation of new employment (CPC 71222).

**Measures:**

*IE: Public Transport Regulation Act 2009.*

*MT: Taxi Services Regulations (SL499.59).*

*PT: Decree-Law 41/80, August 21.*

With respect to Investment liberalisation – Market access and Cross-border trade in services - Local presence:

In **CZ**: Incorporation in the Czech Republic is required (no branches).

**Measures:**

*CZ: Act no. 111/1994. Coll. on Road Transport.*

With respect to Investment liberalisation - Market access, National treatment and Cross-border trade in services - Market access, National treatment, Most-favoured-nation treatment:

In **SE**: In order to engage in the occupation of road transport operator, a Swedish licence is needed. Criteria for receiving a taxi licence include that the company has appointed a natural person to act as the transport manager (a *de facto* residency requirement – see the Swedish reservation on types of establishment).

**Measures:**

**SE:** *Yrkestrafiklag (2012:210) (Act on professional traffic);*

*Yrkestrafikförordning (2012:237) (Government regulation on professional traffic);*

*Taxitrafiklag (2012:211) (Act on Taxis); and*

*Taxitrafikförordning (2012:238) (Government regulation on taxis).*

With respect to Cross-border trade in services – Local presence:

In **SK:** A taxi service concession and a permit for the operation of taxi dispatching can be granted to a person who has a residence or place of establishment in the territory of the Slovak Republic or in another EEA Member State.

**Measures:**

*Act 56/2012 Coll. on Road Transport*

**(d) Services auxiliary to air transport services**

With respect to Investment liberalisation - Market Access, National Treatment and Cross-border trade in services – Market Access, National Treatment:

In **EU:** For groundhandling services, establishment within the European Union territory may be required. The level of openness of groundhandling services depends on the size of airport. The number of suppliers in each airport may be limited. For "big airports", this limit may not be less than two suppliers.

**Measures:**

**EU:** Directive 1996/67/EC of 15 October 1996 on access to the groundhandling market at Community airports.

In **BE** (applies also to the regional level of government): For groundhandling services, reciprocity is required.

**Measures:**

**BE:** *Arrêté Royal du 6 novembre 2010 réglementant l'accès au marché de l'assistance en escale à l'aéroport de Bruxelles-National (Article 18);*

*Besluit van de Vlaamse Regering betreffende de toegang tot de grondafhandelingsmarkt op de Vlaamse regionale luchthavens (Article 14); and*

*Arrêté du Gouvernement wallon réglementant l'accès au marché de l'assistance en escale aux aéroports relevant de la Région wallonne (Article 14).*

**(e) Supporting services for all modes of transport (part of CPC 748)**

With respect to Cross-border trade in services – Local presence:

The **EU** (applies also to the regional level of government): Customs clearance services may only be provided by Union residents or legal persons established in the Union.

**Measures:**

**EU:** Regulation (EU) No 952/2013 of 9 October 2013 of the European Parliament and of the Council establishing the Union Customs Code.

## Reservation No. 17 - Energy related activities

<b>Sector – sub-sector:</b>	Energy related activities - mining and quarrying; production, transmission and distribution on own account of electricity, gas, steam and hot water; pipeline transportation of fuels; storage and warehouse of fuels transported through pipelines; and services incidental to energy distribution
<b>Industry classification:</b>	ISIC Rev. 3.1 10, 11, 12, 13, 14, 40, CPC 5115, 63297, 713, part of 742, 8675, 883, 887
<b>Type of reservation:</b>	Market access National treatment Senior management and boards of directors Local presence
<b>Chapter:</b>	Investment liberalisation; Cross-border trade in services
<b>Level of government:</b>	EU/ Member State (unless otherwise specified)

### Description:

#### **(a) Mining and quarrying (ISIC Rev. 3.1 10, 11, 12, 13, 14, CPC 5115, 7131, 8675, 883)**

#### With respect to Investment liberalisation – Market access:

In **NL**: The exploration for and exploitation of hydrocarbons in the Netherlands is always performed jointly by a private company and the public (limited) company designated by the Minister of Economic Affairs. Articles 81 and 82 of the Mining Act stipulate that all shares in this designated company must be directly or indirectly held by the Dutch State (ISIC Rev. 3.1 10, 3.1 11, 3.1 12, 3.1 13, 3.1 14).

In **BE**: The exploration for and exploitation of mineral resources and other non-living resources in territorial waters and the continental shelf are subject to concession. The concessionaire must have an address for service in Belgium (ISIC Rev. 3.1:14).

In **IT** (applies also to the regional level of government for exploration): Mines belonging to the State have specific exploration and mining rules. Prior to any exploitation activity, a permit for exploration is needed ("permesso di ricerca", Article 4 Royal Decree 1447/1927). This permit has a duration, defines exactly the borders of the ground under exploration and more than one exploration permit may be granted for the same area to different persons or companies (this type of licence is not necessarily exclusive). In order to cultivate and exploit minerals, an authorisation ("concessione", Article 14) from the regional authority is required (ISIC Rev. 3.1 10, 3.1 11, 3.1 12, 3.1 13, 3.1 14, CPC 8675, 883).

### Measures

**BE**: *Arrêté Royal du 1er septembre 2004 relatif aux conditions, à la délimitation géographique et à la procédure d'octroi des concessions d'exploration et d'exploitation des ressources minérales et autres ressources non vivantes de la mer territoriale et du plateau continental.*

*IT: Exploration services: Royal Decree 1447/1927; and Legislative Decree 112/1998, Article 34.*

*NL: Mijnbouwwet (Mining Act).*

With respect to Investment liberalisation – Market access, National treatment, Most-favoured nation treatment:

In **BG**: The activities of prospecting or exploration of underground natural resources on the territory of the Republic of Bulgaria, in the continental shelf and in the exclusive economic zone in the Black Sea are subject to permission, while the activities of extraction and exploitation are subject to concession granted under the Underground Natural Resources Act.

It is forbidden for companies registered in preferential tax treatment jurisdictions (that is, offshore zones) or related, directly or indirectly, to such companies to participate in open procedures for granting permits or concessions for prospecting, exploration or extraction of natural resources, including uranium and thorium ores, as well as to operate an existing permit or concession which has been granted, as such operations are precluded, including the possibility to register the geological or commercial discovery of a deposit as a result of exploration.

The mining of uranium ore is closed by Decree of the Council of Ministers No. 163 of 20.08.1992.

With regard to exploration and mining of thorium ore, the general regime of permits and concessions applies. Decisions to allow the exploration or mining of thorium ore are taken on a non-discriminatory individual case-by-case basis.

According to Decision of the National Assembly of the Republic of Bulgaria of 18 Jan 2012 (ch. 14 June 2012) any usage of hydraulic fracturing technology that is, fracking, for activities of prospecting, exploration or extraction of oil and gas is forbidden.

Exploration and extraction of shale gas is forbidden (ISIC Rev. 3.1 10, 3.1 11, 3.112, 3.1 13,3.1 14).

**Measures:**

*BG: Underground Natural Resources Act;*

*Concessions Act;*

*Law on Privatisation and Post-Privatisation Control;*

*Safe Use of Nuclear Energy Act; Decision of the National Assembly of the Republic of Bulgaria of 18 Jan 2012; Economic and Financial Relations with Companies Registered in Preferential Tax Treatment Jurisdictions, the Persons Controlled Thereby and Their Beneficial Owners Act;; and Subsurface Resources Act.*

With respect to Investment liberalisation – Market access, National treatment, Most-favoured nation treatment:

In **CY**: The Council of Ministers may refuse to allow the activities of prospecting, exploration and exploitation of hydrocarbons to be carried out by any entity which is effectively controlled by the United Kingdom or by nationals of the United Kingdom. After the granting of an authorisation, no entity may come under the direct or indirect control of the United Kingdom or a national of the United Kingdom without the prior approval of the Council of Ministers. The Council of Ministers may

refuse to grant an authorisation to an entity which is effectively controlled by the United Kingdom or by a national of the United Kingdom, if the United Kingdom does not grant entities of the Republic or entities of Member States as regards access to and exercise of the activities of prospecting, exploring for and exploiting hydrocarbons, treatment comparable to that which the Republic or Member State grants entities from the United Kingdom (ISIC Rev 3.1 1110).

**Measures:**

*CY: The Hydrocarbons (Prospecting, Exploration and Exploitation Law) of 2007, (Law 4(I)/2007) as amended.*

With respect to Investment liberalisation – Market Access National treatment and Cross-border services – Local presence:

In **SK**: For mining, activities related to mining and geological activity, incorporation in the EEA is required (no branching). Mining and prospecting activities covered by Act of the Slovak Republic 44/1988 on protection and exploitation of natural resources are regulated on a non-discriminatory basis, including through public policy measures seeking to ensure the conservation and protection of natural resources and the environment such as the authorisation or prohibition of certain mining technologies. For greater certainty, such measures include the prohibition of the use of cyanide leaching in the treatment or refining of minerals, the requirement of a specific authorisation in the case of fracking for activities of prospecting, exploration or extraction of oil and gas, as well as prior approval by local referendum in the case of nuclear/radioactive mineral resources. This does not increase the non-conforming aspects of the existing measure for which the reservation is taken. (ISIC Rev. 3.1 10, 3.1 11, 3.1 12, 3.1 13, 3.1 14, CPC 5115, 7131, 8675 and 883).

**Measures**

*SK: Act 51/1988 on Mining, Explosives and State Mining Administration; and Act 569/2007 on Geological Activity, Act 44/1988 on protection and exploitation of natural resources.*

With respect to Investment liberalisation – Market access and Cross-border trade in services – Local presence:

In **FI**: The exploration for and exploitation of mineral resources are subject to a licensing requirement, which is granted by the Government in relation to the mining of nuclear material. A permit of redemption for a mining area is required from the Government. Permission may be granted to a natural person resident in the EEA or a legal person established in the EEA. An economic needs test may apply (ISIC Rev. 3.1 120, CPC 5115, 883, 8675).

In **IE**: Exploration and mining companies operating in Ireland are required to have a presence there. In the case of minerals exploration, there is a requirement that companies (Irish and foreign) employ either the services of an agent or a resident exploration manager in Ireland while work is being undertaken. In the case of mining, it is a requirement that a State Mining Lease or License be held by a company incorporated in Ireland. There are no restrictions as to ownership of such a company (ISIC Rev. 3.1 10, 3.1 13, 3.1 14, CPC 883).

**Measures**

*FI: Kaivoslaki (Mining Act) (621/2011); and*

*Ydinenergialaki (Nuclear Energy Act) (990/1987).*



**IE:** Minerals Development Acts 1940 – 2017; and Planning Acts and Environmental Regulations.

With respect only to Investment – Market access, National treatment and Cross-border trade in services – Local presence:

In **SI:** The exploration for and exploitation of mineral resources, including regulated mining services, are subject to establishment in or citizenship of the EEA, the Swiss Confederation or an OECD Member (ISIC Rev. 3.1 10, ISIC Rev. 3.1 11, ISIC Rev. 3.1 12, ISIC Rev. 3.1 13, ISIC Rev. 3.1 14, CPC 883, CPC 8675).

**Measures**

**SI:** *Mining Act 2014.*

**(b)** *Production, transmission and distribution on own account of electricity, gas, steam and hot water; pipeline transportation of fuels; storage and warehouse of fuels transported through pipelines; services incidental to energy distribution (ISIC Rev. 3.1 40, 3.1 401, CPC 63297, 713, part of 742, 74220, 887)*

With respect to Investment liberalisation – Market access:

In **DK:** The owner or user intending to establish gas infrastructure or a pipeline for the transport of crude or refined petroleum and petroleum products and of natural gas must obtain a permit from the local authority before commencing work. The number of such permits which are issued may be limited (CPC 7131).

In **MT:** EneMalta plc has a monopoly for the provision of electricity (ISIC Rev. 3.1 401; CPC 887).

In **NL:** the ownership of the electricity network and the gas pipeline network are exclusively granted to the Dutch government (transmission systems) and other public authorities (distribution systems) (ISIC Rev. 3.1 040, CPC 71310).

**Measures:**

**DK:** *Lov om naturgasforsyning, LBK 1127 05/09/2018, lov om varmforsyning, LBK 64 21/01/2019, lov om Energinet, LBK 997 27/06/2018. Bekendtgørelse nr. 1257 af 27. november 2019 om indretning, etablering og drift af olietanke, rørsystemer og pipelines (Order no. 1257 of November 27th, 2019, on the arrangement, establishment and operation of oil tanks, piping systems and pipelines)*

**MT:** *EneMalta Act Cap. 272 and EneMalta (Transfer of Assets, Rights, Liabilities & Obligations) Act Cap. 536.*

**NL:** *Elektriciteitswet 1998; Gaswet.*

With respect to Investment liberalisation – Market access, National treatment, Senior management and boards of directors and Cross-border trade in services – National treatment, Local presence:

In **AT:** With regard to the transportation of gas authorisation is only granted to nationals of a Member State of the EEA domiciled in the EEA. Enterprises and partnerships must have their seat in the EEA. The operator of the network must appoint a Managing Director and a Technical Director

who is responsible for the technical control of the operation of the network, both of whom must be nationals of a member state of the EEA.

The competent authority may waive the nationality and domiciliation requirements where the operation of the network is considered to be in the public interest.

For the transportation of goods other than gas and water, the following applies:

- (i) with regard to natural persons, authorisation is only granted to EEA-nationals who must have a seat in Austria; and
- (ii) enterprises and partnerships must have their seat in Austria. An Economic Needs Test or interest test is applied. Cross border pipelines must not jeopardise Austria's security interests and its status as a neutral country. Enterprises and partnerships have to appoint a managing director who must be a national of a member state of the EEA. The competent authority may waive the nationality and seat requirements if the operation of the pipeline is considered to be in the national economic interest (CPC 713).

**Measures:**

**AT:** *Rohrleitungsgesetz (Law on Pipeline Transport), BGBl. Nr. 411/1975, § 5(1) and (2), §§ 5 (1) and (3), 15, 16; and*

*Gaswirtschaftsgesetz 2011(Gas Act), BGBl. I Nr. 107/2011, Articles 43 and 44, Articles 90 and 93.*

With respect to Investment liberalisation – Market access, National treatment, Senior management and boards of director and Cross-border trade in services – (applies only to the regional level of government) National treatment, Local presence:

In **AT:** With regard to transmission and distribution of electricity, authorisation is only granted to nationals of a Member State of the EEA domiciled in the EEA. If the operator appoints a managing director or a leaseholder, the domicile requirement is waived.

Legal persons (enterprises) and partnerships must have their seat in the EEA. They must appoint a managing director or a leaseholder, both of whom must be nationals of a Member State of the EEA domiciled in the EEA.

The competent authority may waive the domicile and nationality requirements where the operation of the network is considered to be in the public interest (ISIC Rev. 3.1 40, CPC 887).

**Measures:**

**AT:** *Burgenländisches Elektrizitätswesengesetz 2006, LGBl. Nr. 59/2006 as amended;*

*Niederösterreichisches Elektrizitätswesengesetz, LGBl. Nr. 7800/2005 as amended; Landesgesetz, mit dem das Oberösterreichische Elektrizitätswirtschafts- und -*

*organisationsgesetz 2006 erlassen wird (Oö. ElWOG 2006), LGBl. Nr. 1/2006 as amended; Salzburger Landeselektrizitätsgesetz 1999 (LEG), LGBl. Nr. 75/1999 as amended;*

*Gesetz vom 16. November 2011 über die Regelung des Elektrizitätswesens in Tirol (Tiroler*

*Elektrizitätsgesetz 2012 – TEG 2012), LGBl. Nr. 134/2011;*

*Gesetz über die Erzeugung, Übertragung und Verteilung von elektrischer Energie*

*(Vorarlberger Elektrizitätswirtschaftsgesetz), LGBl. Nr. 59/2003 as amended;*

*Gesetz über die Neuregelung der Elektrizitätswirtschaft (Wiener Elektrizitätswirtschaftsgesetz 2005 – WEIWG 2005), LGBl. Nr. 46/2005;*

*Steiermärkisches Elektrizitätswirtschafts- und Organisationsgesetz(ELWOG), LGBl. Nr. 70/2005; and*

*Kärntner Elektrizitätswirtschafts- und Organisationsgesetz(ELWOG), LGBl. Nr. 24/2006.*

With respect to Investment liberalisation – Market access, National treatment and Cross-border trade in services – Local presence:

In **CZ**: For electricity generation, transmission, distribution, trading, and other electricity market operator activities, as well as gas generation, transmission, distribution, storage and trading, as well as heat generation and distribution, authorisation is required. Such authorisation may only be granted to a natural person with a residence permit or a legal person established in the Union. Exclusive rights exist with regard to electricity and gas transmission and market operator licences (ISIC Rev. 3.1 40, CPC 7131, 63297, 742, 887).

In **LT**: The licences for transmission, distribution, public supply and organizing of trade of electricity may only be issued to legal persons established in the Republic of Lithuania or branches of foreign legal persons or other organisations of another Member State established in the Republic Lithuania. The permits to generate electricity, develop electricity generation capacities and build a direct line may be issued to individuals with residency in the Republic of Lithuania or to legal persons established in the Republic of Lithuania, or to branches of legal persons or other organizations of another Member States established in the Republic of Lithuania. This reservation does not apply to consultancy services related to the transmission and distribution on a fee or contract basis of electricity (ISIC Rev. 3.1 401, CPC 887).

In the case of fuels, establishment is required. Licences for transmission and distribution, storage of fuels and liquefaction of natural gas may only be issued to legal persons established in the Republic of Lithuania or branches of legal persons or other organisations (subsidiaries) of another Member State established in the Republic Lithuania.

This reservation does not apply to consultancy services related to the transmission and distribution on a fee or contract basis of fuels (CPC 713, CPC 887).

In **PL**: the following activities are subject to licensing under the Energy Law Act:

- (i) generation of fuels or energy, except for: generation of solid or gaseous fuels; generation of electricity using electricity sources of the total capacity of not more than 50 MW other than renewable energy sources; cogeneration of electricity and heat using sources of the total capacity of not more than 5 MW other than renewable energy sources; generation of heat using the sources of the total capacity of not more than 5 MW;

(ii) storage of gaseous fuels in storage installations, liquefaction of natural gas and regasification of liquefied natural gas at LNG installations, as well as the storage of liquid fuels, except for: the local storage of liquid gas at installations of the capacity of less than 1 MJ/s capacity and the storage of liquid fuels in retail trade;

(iii) transmission or distribution of fuels or energy, except for: the distribution of gaseous fuels in grids of less than 1 MJ/s capacity and the transmission or distribution of heat if the total capacity ordered by customers does not exceed 5 MW;

(iv) trade in fuels or energy, except for: the trade in solid fuels; the trade in electricity using installations of voltage lower than 1 kV owned by the customer; the trade in gaseous fuels if their annual turnover value does not exceed the equivalent of EUR 100 000€; the trade in liquid gas, if the annual turnover value does not exceed EUR 10 000€; and the trade in gaseous fuels and electricity performed on commodity exchanges by brokerage houses which conduct the brokerage activity on the exchange commodities on the basis of the Act of 26 October 2000 on commodity exchanges, as well as the trade in heat if the capacity ordered by the customers does not exceed 5 MW. The limits on turnover do not apply to wholesale trade services in gaseous fuels or liquid gas or to retail services of bottled gas.

A licence may only be granted by the competent authority to an applicant that has registered their principal place of business or residence in the territory of a Member State of the EEA or the Swiss Confederation (ISIC Rev. 3.1 040, CPC 63297, 74220, CPC 887).

**Measures:**

**CZ:** Act No. 458/2000 Coll on Business conditions and public administration in the energy sectors (*The Energy Act*).

**LT:** Law on Natural Gas of the Republic of Lithuania of 10 October 2000 No VIII-1973; and Law on electricity of the Republic of Lithuania of 20 July 2000 No VIII-1881.

**PL:** Energy Law Act of 10 April 1997, Articles 32 and 33.

With respect to Cross-border trade in services – Local presence:

In **SI:** The production, trading, supply to final customers, transmission and distribution of electricity and natural gas is subject to establishment in the Union (ISIC Rev. 3.1 4010, 4020, CPC 7131, CPC 887).

**Measures:**

**SI:** Energetski zakon (Energy Act) 2014, Official Gazette RS, nr. 17/2014; and Mining Act 2014.

## Reservation No. 18 - Agriculture, fishing and manufacturing

<b>Sector – sub-sector:</b>	Agriculture, hunting, forestry; animal and reindeer husbandry, fishing and aquaculture; publishing, printing and reproduction of recorded media
<b>Industry classification:</b>	ISIC Rev. 3.1 011, 012, 013, 014, 015, 1531, 050, 0501, 0502, 221, 222, 323, 324, CPC 881, 882, 88442
<b>Type of reservation:</b>	Market access National treatment Most-favoured-nation treatment Performance requirements Senior management and boards of directors Local presence
<b>Chapter:</b>	Investment liberalisation; Cross-border trade in services
<b>Level of government:</b>	EU/ Member State (unless otherwise specified)

### Description:

#### **(a) Agriculture, hunting and forestry (ISIC Rev. 3.1 011, 012, 013, 014, 015, 1531, CPC 881)**

##### With respect to Investment liberalisation – National treatment:

In **IE**: Establishment by foreign residents in flour milling activities is subject to authorisation (ISIC Rev. 3.1 1531).

##### **Measures:**

**IE**: *Agriculture Produce (Cereals) Act, 1933.*

##### With respect to Investment liberalisation – Market Access, National Treatment:

In **FI**: Only nationals of a Member State of the EEA resident in the reindeer herding area may own reindeer and practice reindeer husbandry. Exclusive rights may be granted.

In **FR**: Prior authorisation is required in order to become a member or act as a director of an agricultural cooperative (ISIC Rev. 3.1 011, 012, 013, 014, 015).

In **SE**: Only Sami people may own and practice reindeer husbandry.

##### **Measures:**

**FI**: *Poronhoitolaki (Reindeer Husbandry Act) (848/1990), Chapter 1, s. 4, Protocol 3 to the Accession Treaty of Finland.*

**FR**: *Code rural et de la pêche maritime.*

**SE**: *Reindeer Husbandry Act (1971:437), section 1.*

**(b) Fishing and aquaculture (ISIC Rev. 3.1 050, 0501, 0502, CPC 882)**

With respect to Investment liberalisation – Market Access, National Treatment and Cross-border Services: Market Access:

In **FR**: A French vessel flying the French flag may be issued a fishing authorisation or may be allowed to fish on the basis of national quotas only when a real economic link on the territory of France is established and the vessel is directed and controlled from a permanent establishment located on the territory of France (ISIC Rev. 3.1 050, CPC 882).

**Measures:**

*FR: Code rural et de la pêche maritime.*

**(c) Manufacturing - Publishing, printing and reproduction of recorded media (ISIC Rev. 3.1 221, 222, 323, 324, CPC 88442)**

With respect to Investment liberalisation – Market Access, National Treatment and Cross-border Services: Market Access, National Treatment, Local presence:

In **LV**: Only legal persons incorporated in Latvia, and natural persons of Latvia have the right to found and publish mass media. Branches are not allowed (CPC 88442).

**Measures:**

*LV: Law on the Press and Other Mass Media, s. 8.*

With respect to Investment liberalisation – National treatment and Cross-border trade in services – Local presence:

In **DE** (applies also to the regional level of government): Each publicly distributed or printed newspaper, journal, or periodical must clearly indicate a "responsible editor" (the full name and address of a natural person). The responsible editor may be required to be a permanent resident of Germany, the Union or an EEA Member State. Exceptions may be allowed by the Federal Minister of the Interior (ISIC Rev. 3.1 223, 224).

**Measures:**

**DE:**

*Regional level:*

*Gesetz über die Presse Baden-Württemberg (LPG BW);*

*Bayerisches Pressegesetz (BayPrG);*

*Berliner Pressegesetz (BlnPrG);*

*Brandenburgisches Landespressegesetz (BbgPG);*

*Gesetz über die Presse Bremen (BrPrG);*

*Hamburgisches Pressegesetz;*

*Hessisches Pressegesetz (HPresseG);*

*Landespressegesetz für das Land Mecklenburg-Vorpommern (LPrG M-V);*

*Niedersächsisches Pressegesetz (NPresseG);*

*Pressegesetz für das Land Nordrhein-Westfalen (Landespressegesetz NRW);*

*Landesmediengesetz (LMG) Rheinland-Pfalz;*

*Saarländisches Mediengesetz (SMG);*

*Sächsisches Gesetz über die Presse (SächsPresseG);*

*Pressegesetz für das Land Sachsen-Anhalt (Landespressegesetz);*

*Gesetz über die Presse Schleswig-Holstein (PressG SH);*

*Thüringer Pressegesetz (TPG).*

With respect to Investment liberalisation – Market Access, National Treatment:

In **IT**: In so far as the United Kingdom allow Italian investors to own more than 49 per cent of the capital and voting rights in a publishing company of the United Kingdom, then Italy will allow investors of the United Kingdom to own more than 49 per cent of the capital and voting rights in an Italian publishing company under the same conditions (ISIC Rev. 3.1 221, 222).

**Measures:**

*IT: Law 416/1981, Article 1 (and subsequent amendments).*

With respect to Investment liberalisation – Senior management and boards of directors:

In **PL**: Nationality is required for the editor-in-chief of newspapers and journals (ISIC Rev. 3.1 221, 222).

**Measures:**

*PL: Act of 26 January 1984 on Press law, Journal of Laws, No. 5, item 24, with subsequent amendments.*

With respect to Investment liberalisation – National treatment and Cross-border trade in services – National treatment, Local presence:

In **SE**: Natural persons who are owners of periodicals that are printed and published in Sweden must reside in Sweden or be nationals of a Member State of the EEA. Owners of such periodicals who are legal persons must be established in the EEA. Periodicals that are printed and published in Sweden and technical recordings must have a responsible editor, who must be domiciled in Sweden (ISIC Rev. 3.1 22, CPC 88442).

**Measures:**

**SE:** *Freedom of the press act (1949:105);*

*Fundamental law on Freedom of Expression (1991:1469); and*

*Act on ordinances for the Freedom of the Press Act and the Fundamental law on Freedom of Expression (1991:1559).*



**Schedule of the United Kingdom**

**Reservation No. 1 – All sectors**

**Reservation No. 2 – Professional services (all professions except health-related)**

**Reservation No. 3 – Professional services (veterinary services)**

**Reservation No. 4 – Research and development services**

**Reservation No. 5 – Business services**

**Reservation No. 6 – Communication services**

**Reservation No. 7 – Transport services and services auxiliary to transport services**

**Reservation No. 8 – Energy related activities**

## **Reservation No. 1 – All sectors**

<b>Sector:</b>	<i>All sectors</i>
<b>Type of reservation:</b>	Market access National treatment Senior management and boards of directors Performance requirements
<b>Chapter:</b>	Investment Liberalisation
<b>Level of government:</b>	Central and Regional (unless otherwise specified)

### **Description:**

#### With respect to Investment Liberalisation – Performance requirements

The United Kingdom may enforce a commitment or undertaking given in accordance with the provisions governing post-offer undertakings in the City Code on Takeovers and Mergers, or pursuant to Deeds of Undertaking in relation to takeovers or mergers, where the commitment or undertaking is not imposed or required as a condition of approval of the takeover or merger.

### **Measures:**

The City Code on Takeovers and Mergers

Companies Act 2006

Law of Property (Miscellaneous Provisions) Act 1989 as regards enforcement of Deeds of Undertaking in relation to takeovers or mergers

#### With respect to Investment Liberalisation – Market access, National treatment and Senior management and boards of directors

This reservation applies only to health, social or education services:

The UK, when selling or disposing of its equity interests in, or the assets of, an existing state enterprise or an existing governmental entity providing health, social or education services (CPC 93, 92), may prohibit or impose limitations on the ownership of such interests or assets, and on the ability of owners of such interests and assets to control any resulting enterprise, by investors of the Union or their enterprises. With respect to such a sale or other disposition, the UK may adopt or maintain any measure relating to the nationality of senior management or members of the boards of directors, as well as any measure limiting the number of suppliers.

For the purposes of this reservation:

- (i) any measure maintained or adopted after entry into force of this Agreement that, at the time of the sale or other disposition, prohibits or imposes limitations on the ownership of equity interests or assets or imposes nationality requirements or

imposes limitations on the numbers of suppliers as described in this reservation shall be deemed to be an existing measure; and

- (ii) 'state enterprise' means an enterprise owned or controlled through ownership interests by the UK and includes an enterprise established after entry into force of this Agreement solely for the purposes of selling or disposing of equity interests in, or the assets of, an existing state enterprise or governmental entity.

**Measures:**

As set out in the Description element as indicated above.

## **Reservation No. 2 – Professional services (all professions except health-related)**

<b>Sector – sub-sector:</b>	Professional services – legal services; auditing services
<b>Industry classification:</b>	Part of CPC 861, CPC 862
<b>Type of reservation:</b>	Market access National treatment Local presence
<b>Chapter:</b>	Investment liberalisation and Cross-border trade in services
<b>Level of government:</b>	Central and Regional (unless otherwise specified)

### **Description:**

#### **(a) Legal services (part of CPC 861)**

In order to provide certain legal services, it may be necessary to obtain authorisation or a licence from a competent authority, or to comply with registration requirements. To the extent that the requirements for obtaining authorisation or a licence, or registration, are non-discriminatory and conform with commitments imposed by Article SERVIN 5.49, they are not listed. These may, for example, include a requirement to having obtained specified qualifications, having completed a recognised period of training, or requiring upon membership an office or a post address within the competent authority's jurisdiction.

With respect to Investment Liberalisation – Market access, National treatment and Cross-Border Trade in Services – Market access, Local presence, National treatment:

Residency (commercial presence) may be required by the relevant professional or regulatory body for the provision of some UK domestic legal services. Non-discriminatory legal form requirements apply.

Residency may be required by the relevant professional or regulatory body for the provision of certain UK domestic legal services in relation to immigration.

#### **Measures:**

For England and Wales, the Solicitors Act 1974, the Administration of Justice Act 1985 and the Legal Services Act 2007. For Scotland, the Solicitors (Scotland) Act 1980 and the Legal Services (Scotland) Act 2010. For Northern Ireland, the Solicitors (Northern Ireland) Order 1976. For all jurisdictions, the Immigration and Asylum Act 1999. In addition, the measures applicable in each jurisdiction include any requirements set by professional and regulatory bodies.

#### **(b) Auditing services (CPC 86211, 86212 other than accounting and bookkeeping services)**

With respect to Investment Liberalisation – National treatment and Cross-Border Trade in Services – National treatment:

The competent authorities of the UK may recognise the equivalence of the qualifications of an auditor who is a national of the Union or of any third country in order to approve them to act as a statutory auditor in the UK subject to reciprocity (CPC 8621).

***Measures:***

The Companies Act 2006

### **Reservation No. 3 – Professional services (veterinary services)**

<b>Sector – sub-sector:</b>	Professional services – veterinary services
<b>Industry classification:</b>	CPC 932
<b>Type of reservation:</b>	Market access Local presence
<b>Chapter:</b>	Investment liberalisation and Cross-border trade in services
<b>Level of government:</b>	Central and Regional (unless otherwise specified)

#### **Description:**

Physical presence is required to perform veterinary surgery. The practice of veterinary surgery is reserved to qualified veterinary surgeons who are registered with the Royal College of Veterinary Surgeons (RCVS).

#### **Measures:**

Veterinary Surgeons Act 1966

#### **Reservation No. 4 – Research and development services**

<b>Sector – sub-sector:</b>	Research and development (R&D) services
<b>Industry classification:</b>	CPC 851, 853
<b>Type of reservation:</b>	Market access National treatment Local presence
<b>Chapter:</b>	Investment liberalisation and Cross-border trade in services
<b>Level of government:</b>	Central and Regional (unless otherwise specified)

#### **Description:**

For publicly funded research and development (R&D) services benefitting from funding provided by the UK, exclusive rights or authorisations may only be granted to nationals of the UK and to legal persons of the UK having their registered office, central administration or principal place of business in the UK (CPC 851, 853).

This reservation is without prejudice to [Part Five] [Participation in Union Programmes, Sound Financial Management and Financial Provisions] and to the exclusion of procurement by a Party or subsidies or grants in paragraph 6 and 7 of Article SERVIN 1.1 [Objective and scope].

#### **Measures:**

All currently existing and all future research or innovation programmes.

## Reservation No. 5 – Business services

**Sector – sub-sector:** Business services – rental or leasing services without operators and other business services

**Industry classification:** Part of CPC 831

**Type of reservation:** Market access  
National treatment  
Most-favoured-nation treatment

**Chapter:** Investment Liberalisation and Cross-Border Trade in Services

**Level of government:** Central and Regional (unless otherwise specified)

### Description:

For rental or leasing of aircraft without crew (dry lease) aircraft used by an air carrier of the UK are subject to applicable aircraft registration requirements. A dry lease agreement to which a UK carrier is a party shall be subject to requirements in the national law on aviation safety, such as prior approval and other conditions applicable to the use of third countries' registered aircraft. To be registered, aircraft may be required to be owned either by natural persons meeting specific nationality criteria or by enterprises meeting specific criteria regarding ownership of capital and control (CPC 83104).

With respect to computer reservation system (CRS) services, where the UK air carriers are not accorded, by CRS services suppliers operating outside the UK, equivalent (meaning non-discriminatory) treatment to that provided in the UK, or where UK CRS services suppliers are not accorded, by non-UK air carriers, equivalent treatment to that provided in the UK, measures may be taken to accord equivalent discriminatory treatment, respectively, to the non-UK air carriers by the CRS services suppliers operating in the UK, or to the non-UK CRS services suppliers by UK air carriers.

**Measures:** Regulation (EC) No 1008/2008 of the European Parliament and of the Council of 24 September 2008 on common rules for the operation of air services in the Community (Recast) as retained in UK law by the European Union (Withdrawal) Act 2018 and as amended by the Operation of Air Services (Amendment etc.) (EU Exit) Regulations (S.I. 2018/1392).

Regulation (EC) No 80/2009 of the European Parliament and of the Council of 14 January 2009 on a Code of Conduct for computerised reservation systems and repealing Council Regulation (EEC) No 2299/89, as retained in UK law by the European Union (Withdrawal) Act 2018 and as amended by the Computer Reservation Systems (Amendment) (EU Exit) Regulations 2018 (S.I. 2018/1080).



**Reservation No. 6 – Communication services**

<b>Sector – sub-sector:</b>	Communication services - postal and courier services
<b>Industry classification:</b>	Part of CPC 71235, part of 73210, part of 751
<b>Type of reservation:</b>	Market access
<b>Chapter:</b>	Investment Liberalisation and Cross-Border Trade in Services
<b>Level of government:</b>	Central and Regional (unless otherwise specified)

**Description:**

The organisation of the siting of letter boxes on the public highway, the issuing of postage stamps and the provision of the registered mail service used in the course of judicial or administrative procedures may be restricted in accordance with national legislation. For greater certainty, postal operators may be subject to particular universal service obligations or a financial contribution to a compensation fund.

**Measures:**

Postal Services Act 2011

## **Reservation No. 7 – Transport services and services auxiliary to transport services**

<b>Sector – sub-sector:</b>	Transport services - auxiliary services for water transport, auxiliary services to rail transport, services auxiliary to road transport, services auxiliary to air transport services
<b>Industry classification:</b>	CPC 711, 712, 721, 741, 742, 743, 744, 745, 746, 748, 749
<b>Type of reservation:</b>	Market access National treatment Local presence
<b>Chapter:</b>	Investment Liberalisation and Cross-Border Trade in Services
<b>Level of government:</b>	Central and Regional (unless otherwise specified)

### **Description:**

#### **(a) Services auxiliary to air transport services (CPC 746)**

With respect to Investment Liberalisation - Market access and Cross-Border Trade in Services - Market access:

The level of openness of groundhandling services depends on the size of airport. The number of suppliers in each airport may be limited. For ‘big airports’, this limit may not be less than two suppliers.

#### **Measures:**

The Airports (Groundhandling) Regulations 1997 (S.I. 1997/2389)

#### **(b) Supporting services for all modes of transport**

With respect to Investment Liberalisation - National treatment and Cross-Border Trade in Services - Market access, Local presence, National treatment:

Customs services, including customs clearance services and services relating to use of temporary storage facilities or customs warehouses, may only be provided by persons established in the UK. For the avoidance of doubt, this includes UK residents, persons with a permanent place of business in the UK or a registered office in the UK.

#### **Measures:**

Taxation (Cross-Border Trade Act) 2018; the Customs and Excise Management Act 1979; the Customs (Export) (EU Exit) Regulations 2019; the Customs (Import Duty) (EU Exit) Regulations 2018; the Customs (Special Procedures and Outward Processing) (EU Exit) Regulations 2018; the Customs and Excise (Miscellaneous Provisions and Amendments) (EU Exit) Regulations 2019/1215.

#### **(c) Auxiliary services for water transport**

With respect to Investment Liberalisation – Market Access, and Cross-Border Trade in Services – Market Access:

For port services, the managing body of a port, or the competent authority, may limit the number of providers of port services for a given port service.

**Measures:**

Regulation (EU) 2017/352 of 15 February 2017 establishing a framework for the provision of port services and common rules on the financial transparency of ports, Article 6 as retained in UK law by the European Union (Withdrawal) Act 2018 and as amended by the Pilotage and Port Services (Amendment) (EU Exit) Regulations 2020 (S.I. 2020/671)

Port Services Regulations 2019

## **Reservation No. 8 – Energy related activities**

<b>Sector – sub-sector:</b>	Energy related activities - mining and quarrying
<b>Industry classification:</b>	ISIC Rev. 3.1 11, 8675, 883
<b>Type of reservation:</b>	Market access
<b>Chapter:</b>	Investment Liberalisation and Cross-Border Trade in Services
<b>Level of government:</b>	Central and Regional (unless otherwise specified)

### **Description:**

A licence is necessary to undertake exploration and production activities on the UK Continental Shelf (UKCS), and to provide services which require direct access to or exploitation of natural resources.

This reservation applies to production licences issued with respect to the UK Continental Shelf. To be a Licensee, a company must have a place of business within the UK. That means either:

- (i) a staffed presence in the UK;
- (ii) registration of a UK company at Companies House; or
- (iii) registration of a UK branch of a foreign company at Companies House.

This requirement exists for any company applying for a new licence and for any company seeking to join an existing licence by assignment. It applies to all licences and to all enterprises, whether operator or not. To be a party to a licence that covers a producing field, a company must: (a) be registered at Companies House as a UK company; or (b) carry on its business through a fixed place of business in the UK as defined in section 148 of the Finance Act 2003 (which normally requires a staffed presence) (ISIC Rev. 3.1 11, CPC 883, 8675).

### **Measures:**

Petroleum Act 1998

## ANNEX SERVIN-2: FUTURE MEASURES

### Headnotes

1. The Schedules of the United Kingdom and the Union set out, under Article SERVIN 2.7 [Non-conforming measures – Investment liberalisation], Article SERVIN.3.6 [Non-conforming measures – Cross-border trade in services] and Article SERVIN.5.50 [Non-conforming measures – Legal services], the reservations taken by the United Kingdom and the Union with respect to existing measures that do not conform with obligations imposed by:
  - (a) Articles SERVIN.2.2 [Market access– Investment liberalisation] or SERVIN.3.2 [Market access - Cross-border trade in services];
  - (b) Article SERVIN.3.3 [Local presence – Cross-border trade in services];
  - (c) Articles SERVIN.2.3 [National treatment– Investment liberalisation] or SERVIN.3.4 [National treatment - Cross-border trade in services];
  - (d) Articles SERVIN.2.4 [Most-favoured-nation treatment– Investment liberalisation], or SERVIN.3.5 [Most-favoured-nation treatment - Cross-border trade in services];
  - (e) Article SERVIN.2.5 [Senior management and boards of directors];
  - (f) Article SERVIN.2.6 [Performance requirements]; or
  - (g) Article SERVIN.5.49 [Obligations – Legal services].
2. The reservations of a Party are without prejudice to the rights and obligations of the Parties under GATS.
3. Each reservation sets out the following elements:
  - (a) “sector” refers to the general sector in which the reservation is taken;
  - (b) “sub-sector” refers to the specific sector in which the reservation is taken;
  - (c) “industry classification” refers, where applicable, to the activity covered by the reservation according to the CPC, ISIC rev 3.1, or as expressly otherwise described in a Party's reservation;
  - (d) “type of reservation” specifies the obligation referred to in paragraph 1 for which a reservation is taken;
  - (e) “description” sets out the scope of the sector, sub-sector or activities covered by the reservation; and
  - (f) “existing measures” identifies, for transparency purposes, existing measures that apply to the sector, sub-sector or activities covered by the reservation.
4. In the interpretation of a reservation, all elements of the reservation shall be considered. The “description” element shall prevail over all other elements.
5. For the purposes of the Schedules of the United Kingdom and the European Union:

(a) 'ISIC Rev. 3.1' means the International Standard Industrial Classification of All Economic Activities as set out in Statistical Office of the United Nations, Statistical Papers, Series M, No.4, ISIC Rev. 3.1, 2002;

(b)'CPC' means the Provisional Central Product Classification (Statistical Papers, Series M No. 77, Department of Interntional Economic and Social Affairs, Statistical Office of the United Nations, New York,1991).

6. For the purposes of the Schedules of the United Kingdom and the Union, a reservation for a requirement to have a local presence in the territory of the Union or the United Kingdom is taken against Article SERVIN 3.3 [Local presence], and not against Article SERVIN 3.2 [Market access] or SERVIN 3.4 [National treatment]. Furthermore, such a requirement is not taken as a reservation against Article SERVIN 2.3 [National treatment].

7. A reservation taken at the level of the Union applies to a measure of the Union, to a measure of a Member State at the central level or to a measure of a government within a Member State, unless the reservation excludes a Member State. A reservation taken by a Member State applies to a measure of a government at the central, regional or local level within that Member State. For the purposes of the reservations of Belgium, the central level of government covers the federal government and the governments of the regions and the communities as each of them holds equipollent legislative powers. For the purposes of the reservations of the Union and its Member States, a regional level of government in Finland means the Åland Islands. A reservation taken at the level of the United Kingdom applies to a measure of the central government, a regional government or a local government.

8. The list of reservations below does not include measures relating to qualification requirements and procedures, technical standards and licensing requirements and procedures where they do not constitute a limitation within the meaning of Article SERVIN.2.2 [Market Access – Investment liberalisation], Article SERVIN.2.3 [National Treatment – Investment liberalisation], Article SERVIN.3.2 [Market access – Cross-border trade in services], Article SERVIN.3.3 [Local presence – Cross-Border Trade in Services], Article SERVIN.3.4 [National treatment – Cross-sorder trade in services] or Article SERVIN 5.49 [Obligations – Legal services]. These measures may include, in particular the need to obtain a licence, to satisfy universal service obligations, to have recognised qualifications in regulated sectors, to pass specific examinations, including language examinations, to fulfil a membership requirement of a particular profession, such as membership in a professional organisation, to have a local agent for service, or to maintain a local address, or any other non-discriminatory requirements that certain activities may not be carried out in protected zones or areas. While not listed, such measures continue to apply.

9. For greater certainty, for the European Union, the obligation to grant national treatment does not entail the requirement to extend to natural or legal persons of the United Kingdom the treatment granted in a Member State, pursuant to the Treaty on the Functioning of the European Union, or any measure adopted pursuant to that Treaty, including their implementation in the Member States, to:

(i) natural persons or residents of another Member State; or

(ii) legal persons constituted or organised under the law of another Member State or of the Union and having their registered office, central administration or principal place of business in the Union.

10. Treatment granted to legal persons established by investors of a Party in accordance with the law of the other Party (including, in the case of the Union, the law of a Member State) and having their registered office, central administration or principal place of business within that other Party, is without prejudice to any condition or obligation, consistent with Chapter 2 [Investment Liberalisation] of Title II [Services and Investment] of Heading One [Trade] of Part Two [Trade, transport and fisheries], which may have been imposed on such legal person when it was established in that other Party, and which shall continue to apply.

11. The schedules apply only to the territories of the United Kingdom and the European Union in accordance with Article FINPROV.1 [Territorial Scope] and Article OTH.9.2 [Geographical Scope] and are only relevant in the context of trade relations between the Union and its Member States with the United Kingdom. They do not affect the rights and obligations of the Member States under Union law.

12. For greater certainty, non-discriminatory measures do not constitute a market access limitation within the meaning of Articles SERVIN. 2.2 [Market access – Investment liberalisation], or SERVIN.3.2 [Market access – Cross-border trade in services] or Article SERVIN.5.49 [Obligations – Legal services] for any measure:

- (a) requiring the separation of the ownership of infrastructure from the ownership of the goods or services provided through that infrastructure to ensure fair competition, for example in the fields of energy, transportation and telecommunications;
- (b) restricting the concentration of ownership to ensure fair competition;
- (c) seeking to ensure the conservation and protection of natural resources and the environment, including a limitation on the availability, number and scope of concessions granted, and the imposition of a moratorium or ban;
- (d) limiting the number of authorisations granted because of technical or physical constraints, for example telecommunications spectra and frequencies; or
- (e) requiring that a certain percentage of the shareholders, owners, partners, or directors of an enterprise be qualified or practice a certain profession such as lawyers or accountants.

13. With respect to financial services: Unlike foreign subsidiaries, branches established directly in a Member State by a non-European Union financial institution are not, with certain limited exceptions, subject to prudential regulations harmonised at European Union level which enable such subsidiaries to benefit from enhanced facilities to set up new establishments and to provide cross-border services throughout the Union. Therefore, such branches receive an authorisation to operate in the territory of a Member State under conditions equivalent to those applied to domestic financial institutions of that Member State, and may be required to satisfy a number of specific prudential requirements such as, in the case of banking and securities, separate capitalisation and other solvency requirements and reporting and publication of accounts requirements or, in the case of insurance, specific guarantee and deposit requirements, a separate capitalisation, and the localisation in the Member State concerned of the assets representing the technical reserves and at least one third of the solvency margin.

The following abbreviations are used in the list of reservations below:

UK United Kingdom

EU European Union, including all its Member States

AT Austria

BE Belgium

BG Bulgaria

CY Cyprus

CZ Czech Republic

DE Germany

DK Denmark

EE Estonia

EL Greece

ES Spain

FI Finland

FR France

HR Croatia

HU Hungary

IE Ireland

IT Italy

LT Lithuania

LU Luxembourg

LV Latvia

MT Malta

NL The Netherlands

PL Poland

PT Portugal

RO Romania

SE Sweden

SI Slovenia

SK Slovak Republic



## Schedule of the Union

**Reservation No. 1 - All sectors**

**Reservation No. 2 - Professional services – other than health related services**

**Reservation No. 3 - Professional services – health related and retail of pharmaceuticals**

**Reservation No. 4 - Business Services - Research and development services**

**Reservation No. 5 - Business Services - Real estate services**

**Reservation No. 6 - Business services - Rental or leasing services**

**Reservation No. 7 - Business Services - Collection agency services and Credit reporting services**

**Reservation No. 8 - Business Services - Placement services**

**Reservation No. 9 - Business Services - Security and investigation services**

**Reservation No. 10 - Business Services - Other business services**

**Reservation No. 11 - Telecommunication**

**Reservation No. 12 - Construction**

**Reservation No. 13 - Distribution services**

**Reservation No. 14 - Education services**

**Reservation No. 15 - Environmental services**

**Reservation No. 16 – Financial Services**

**Reservation No. 17 - Health services and social services**

**Reservation No. 18 - Tourism and travel related services**

**Reservation No. 19 - Recreational, cultural and sporting services**

**Reservation No. 20 - Transport services and auxiliary transport services**

**Reservation No. 21 - Agriculture, fishing and water**

**Reservation No. 22 - Energy related activities**

**Reservation No. 23 - Other services not included elsewhere**

## Reservation No. 1 - All sectors

**Sector:** *All sectors*

**Type of reservation:** Market access  
National treatment  
Most favoured nation treatment  
Senior management and board of directors  
Performance requirements  
Local presence  
Obligations for Legal Services

**Chapter / Section:** Investment liberalisation, Cross-border trade in services and  
Regulatory Framework for Legal Services

### **Description:**

The EU reserves the right to adopt or maintain any measure with respect to the following:

#### **(a) Establishment**

##### With respect to Investment liberalisation – Market access:

The EU: Services considered as public utilities at a national or local level may be subject to public monopolies or to exclusive rights granted to private operators.

Public utilities exist in sectors such as related scientific and technical consulting services, research and development (R&D) services on social sciences and humanities, technical testing and analysis services, environmental services, health services, transport services and services auxiliary to all modes of transport. Exclusive rights on such services are often granted to private operators, for instance operators with concessions from public authorities, subject to specific service obligations. Given that public utilities often also exist at the sub-central level, detailed and exhaustive sector-specific scheduling is not practical. This reservation does not apply to telecommunications and to computer and related services.

##### With respect to Investment liberalisation – Market access, National treatment; Cross-border trade in services – Market access, National treatment and Regulatory framework for Legal services – Obligations:

In FI: Restrictions on the right for natural persons, who do not enjoy regional citizenship in Åland, and for legal persons, to acquire and hold real property on the Åland Islands without obtaining permission from the competent authorities of the Åland Islands. Restrictions on the right of establishment and right to carry out economic activities by natural persons, who do not enjoy regional citizenship in Åland, or by any enterprise, without obtaining permission from the competent authorities of the Åland Islands.

#### **Existing measures:**

FI: Ahvenanmaan maanhankintalaki (Act on land acquisition in Åland) (3/1975), s. 2; and Ahvenanmaan itsehallintolaki (Act on the Autonomy of Åland) (1144/1991), s. 11.

With respect to Investment liberalisation – Market access, National treatment, Performance requirements, Senior management and boards of directors; Regulatory Framework for Legal Services – Obligations:

In **FR**: Pursuant to articles L151-1 and 151-1 et seq of the financial and monetary code, foreign investments in France in sectors listed in article R.151-3 of the financial and monetary code are subject to prior approval from the Minister for the Economy.

**Existing measures:**

**FR**: As set out in the description element as indicated above.

With respect to Investment liberalisation – National treatment, Senior management and boards of directors:

In **FR**: Limiting foreign participation in newly privatised companies to a variable amount, determined by the government of France on a case by case basis, of the equity offered to the public. For establishing in certain commercial, industrial or artisanal activities, a specific authorisation is needed if the managing director is not a holder of a permanent residence permit.

With respect to Investment liberalisation – Market access and Regulatory framework for Legal services – Obligations:

In **HU**: Establishment should take a form of limited liability company, joint-stock company or representative office. Initial entry as a branch is not permitted except for financial services.

With respect to Investment liberalisation – Market access, National treatment:

In **BG**: Certain economic activities related to the exploitation or use of State or public property are subject to concessions granted under the provisions of the Concessions Act.

In commercial corporations in which the State or a municipality holds a share in the capital exceeding 50 per cent, any transactions for disposition of fixed assets of the corporation, to conclude any contracts for acquisition of participating interest, lease, joint activity, credit, securing of receivables, as well as incurring any obligations arising under bills of exchange, are subject to authorisation or permission by the Privatisation Agency or other state or regional bodies, whichever is the competent authority. This reservation does not apply to mining and quarrying, which are subject to a separate reservation in the schedule of the European Union in ANNEX SERVIN-1.

In **IT**: The Government may exercise certain special powers in enterprises operating in the areas of defence and national security, and in certain activities of strategic importance in the areas of energy, transport and communications. This applies to all juridical persons carrying out activities considered of strategic importance in the areas of defence and national security, not only to privatised companies.

If there is a threat of serious injury to the essential interests of defence and national security, the Government has following special powers to:

- (a) to impose specific conditions in the purchase of shares;
- (b) to veto the adoption of resolutions relating to special operations such as transfers, mergers, splitting up and changes of activity; or

(c) to reject the acquisition of shares, where the buyer seeks to hold a level of participation in the capital that is likely to prejudice the interests of defence and national security.

Any resolution, act or transaction (such as transfers, mergers, splitting up, change of activity or termination) relating to strategic assets in the areas of energy, transport and communications shall be notified by the concerned company to the Prime Minister's office. In particular, acquisitions by any natural or juridical person outside the European Union that give this person control over the company shall be notified.

The Prime Minister may exercise the following special powers:

(a) to veto any resolution, act and transaction that constitutes an exceptional threat of serious injury to the public interest in the security and operation of networks and supplies;

(b) to impose specific conditions in order to guarantee the public interest; or

(c) to reject an acquisition in exceptional cases of risk to the essential interests of the State.

The criteria on which to evaluate the real or exceptional threat and conditions and procedures for the exercise of the special powers are laid down in the law.

***Existing measures:***

**IT:** Law 56/2012 on special powers in companies operating in the field of defence and national security, energy, transport and communications; and

Decree of the Prime Minister DPCM 253 of 30.11.2012 defining the activities of strategic importance in the field of defence and national security.

With respect to Investment liberalisation – Market access, National treatment, Most-favoured nation treatment, Performance requirements, Senior management and boards of directors:

In **LT:** Enterprises, sectors and facilities of strategic importance to national security.

***Existing measures:***

**LT:** Law on the Protection of Objects of Importance to Ensuring National Security of the Republic of Lithuania of 10 October 2002 No. IX-1132 (as last amended on 12 of January 2018 No XIII-992).

With respect to Investment liberalisation – National treatment and Senior management and boards of directors:

In **SE:** Discriminatory requirements for founders, senior management and boards of directors when new forms of legal association are incorporated into Swedish law.

***(b) Acquisition of real estate***

With respect to Investment liberalisation – Market access, National treatment, Senior management and boards of directors:

In **HU:** The acquisition of state-owned properties.

With respect to Investment liberalisation – Market access, National treatment:

In **HU**: The acquisition of arable land by foreign legal persons and non-resident natural persons.

**Existing measures:**

**HU**: Act CXXII of 2013 on the circulation of agricultural and forestry land (Chapter II

(Paragraph 6-36) and Chapter IV (Paragraph 38-59)); and

Act CCXII of 2013 on the transitional measures and certain provisions related to Act CXXII of 2013 on the circulation of agricultural and forestry land (Chapter IV (Paragraph 8-20)).

In **LV**: The acquisition of rural land by nationals of the United Kingdom or of a third country.

**Existing measures:**

**LV**: Law on land privatisation in rural areas, ss. 28, 29, 30.

In **SK**: Foreign companies or natural persons may not acquire agricultural and forest land outside the borders of the built-up area of a municipality and some other land (e.g. natural resources, lakes, rivers, public roads etc.).

**Existing measures:**

**SK**: Act No 44/1988 on protection and exploitation of natural resources;

Act No 229/1991 on regulation of the ownership of land and other agricultural property;

Act No 460/1992 Constitution of the Slovak Republic;

Act No 180/1995 on some measures for land ownership arrangements;

Act No 202/1995 on Foreign Exchange;

Act No 503/2003 on restitution of ownership to land;

Act No 326/2005 on Forests; and

Act No 140/2014 on the acquisition of ownership of agricultural land.

With respect to Investment liberalisation – National treatment and Cross-border trade in services – Local presence:

In **BG**: Foreign natural and legal persons cannot acquire land. Legal persons of Bulgaria with foreign participation cannot acquire agricultural land. Foreign legal persons and foreign natural persons with permanent residence abroad can acquire buildings and real estate property rights (right to use, right to build, right to raise a superstructure and servitudes). Foreign natural persons with permanent residence abroad, foreign legal persons in which foreign participation ensures a majority in adopting decisions or blocks the adoption of decisions, can acquire real estate property rights in specific geographic regions designated by the Council of Ministers subject to permission.

**BG**: Constitution of the Republic of Bulgaria, article 22; Law on Ownership and Use of Agricultural Land, article 3; and Law on Forests, article 10.

In **EE**: Foreign natural or legal persons that are not from the EEA or from members of the Organisation for Economic Co-operation and Development can acquire an immovable asset which contains agricultural and/or forest land only with the authorisation of the county governor and of the municipal council, and must prove as prescribed by law that the immovable asset will, according to its intended purpose, be used efficiently, sustainably and purposefully.

**Existing measures:**

**EE**: Kinnisasja omandamise kitsendamise seadus (Restrictions on Acquisition of Immovables Act) Chapters 2 and 3.

With respect to Investment liberalisation – Market access, National treatment and Cross-border trade in services - Market access, National treatment:

In **LT**: Any measure which is consistent with the commitments taken by the European Union and which are applicable in Lithuania in GATS with respect to land acquisition. The land plot acquisition procedure, terms and conditions, as well as restrictions shall be established by the Constitutional Law, the Law on Land and the Law on the Acquisition of Agricultural Land.

However, local governments (municipalities) and other national entities of Members of the Organisation for Economic Co-operation and Development and North Atlantic Treaty Organization conducting economic activities in Lithuania, which are specified by the constitutional law in compliance with the criteria of European Union and other integration which Lithuania has embarked on, are permitted to acquire into their ownership non-agricultural land plots required for the construction and operation of buildings and facilities necessary for their direct activities.

**Existing measures:**

**LT**: Constitution of the Republic of Lithuania;

The Constitutional Law of the Republic of Lithuania on the Implementation of Paragraph 3 of Article 47 of the Constitution of the Republic of Lithuania of 20 June 1996, No. I-1392 as last amended 20 March 2003, No. IX-1381;

Law on land, of 27 January 2004, No. IX-1983; and

Law on acquisition of agricultural land of 24 April 2014, No. XII-854.

**(c) Recognition**

With respect to Investment liberalisation –National treatment and Cross-border trade in services – National treatment:

In **EU**: The European Union directives on mutual recognition of diplomas and other professional qualification only apply to the citizens of the Union. The right to practise a regulated professional service in one Member State does not grant the right to practise in another Member State.

**(d) Most-Favoured-Nation Treatment**

With respect to Investment liberalisation – Most-favoured-nation treatment and Cross-border trade in services – Most-favoured-nation treatment and Regulatory Framework for Legal Services – Obligations:

The **EU**: According differential treatment to a third country pursuant to any international investment treaties or other trade agreement in force or signed prior to the date of entry into force of this Agreement.

The **EU**: According differential treatment to a third country pursuant to any existing or future bilateral or multilateral agreement which:

- (i) creates an internal market in services and investment;
- (ii) grants the right of establishment; or
- (iii) requires the approximation of legislation in one or more economic sectors.

An internal market in services and investment means an area without internal frontiers in which the free movement of services, capital and persons is ensured.

The right of establishment means an obligation to abolish in substance all barriers to establishment among the parties to the bilateral or multilateral agreement by the entry into force of that agreement. The right of establishment shall include the right of nationals of the parties to the bilateral or multilateral agreement to set up and operate enterprises under the same conditions provided for nationals under the law of the Party where such establishment takes place.

The approximation of legislation means:

- (i) the alignment of the legislation of one or more of the parties to the bilateral or multilateral agreement with the legislation of the other Party or parties to that agreement; or
- (ii) the incorporation of common legislation into the law of the parties to the bilateral or multilateral agreement.

Such alignment or incorporation shall take place, and shall be deemed to have taken place, only at such time that it has been enacted in the law of the Party or parties to the bilateral or multilateral agreement.

***Existing measures:***

**EU**: Agreement on the European Economic Area;

Stabilisation Agreements;

EU-Swiss Confederation bilateral agreements; and

Deep and Comprehensive Free Trade Agreements.

The **EU**: According differential treatment relating to the right of establishment to nationals or enterprises through existing or future bilateral agreements between the following Member States: **BE, DE, DK, EL, ES, FR, IE, IT, LU, NL, PT** and any of the following countries or principalities: Andorra, Monaco, San Marino and the Vatican City State.

In **DK, FI, SE**: Measures taken by Denmark, Sweden and Finland aimed at promoting Nordic cooperation, such as:

- (a) financial support to research and development (R&D) projects (the Nordic Industrial Fund);

(b) funding of feasibility studies for international projects (the Nordic Fund for Project Exports); and

(c) financial assistance to companies utilizing environmental technology (the Nordic Environment Finance Corporation). The purpose of the Nordic Environment Finance Corporation (NEFCO) is to promote investments of Nordic environmental interest, with a focus on Eastern Europe.

This reservation is without prejudice to the exclusion of procurement by a Party or subsidies paragraphs 6 and 7 of Article SERVIN.1.1 [Objective and scope].

In **PL**: Preferential conditions for establishment or the cross-border supply of services, which may include the elimination or amendment of certain restrictions embodied in the list of reservations applicable in Poland, may be extended through commerce and navigation treaties.

In **PT**: Waiving nationality requirements for the exercise of certain activities and professions by natural persons supplying services for countries in which Portuguese is the official language (Angola, Brazil, Cape Verde, Guinea-Bissau, Equatorial Guinea, Mozambique, São Tomé & Príncipe, and East Timor).

**(e) Arms, munition and war material**

With respect to Investment liberalisation – Market access, National treatment, Most-favoured nation treatment, Senior management and boards of directors, Performance requirements and Cross-border trade in services – Market access, National treatment, Most-favoured-nation treatment, Local presence:

In **EU**: Production or distribution of, or trade in, arms, munitions and war material. War material is limited to any product which is solely intended and made for military use in connection with the conduct of war or defence activities.



## Reservation No. 2 - Professional services - other than health related services

<b>Sector:</b>	Professional services - legal services: services of notaries and by bailiffs; accounting and bookkeeping services; auditing services, taxation advisory services; architecture and urban planning services, engineering services, and integrated engineering services
<b>Industry classification:</b>	Part of CPC 861, part of 87902, 862, 863, 8671, 8672, 8673, 8674, part of 879
<b>Type of reservation:</b>	Market access National treatment Most favoured nation treatment Senior management and board of directors
<b>Chapter:</b>	Investment Liberalisation and Cross-Border Trade in Services

### Description:

The EU reserves the right to adopt or maintain any measure with respect to the following:

#### **(a) Legal services**

With respect to Investment liberalisation – Market access, National treatment, Senior management and boards of directors and Cross-border trade in services – Market access, National treatment:

The **EU**, with the exception of **SE**: The supply of legal advisory and legal authorisation, documentation, and certification services provided by legal professionals entrusted with public functions, such as notaries, "*huissiers de justice*" or other "*officiers publics et ministériels*", and with respect to services provided by bailiffs who are appointed by an official act of government (part of CPC 861, part of 87902).

With respect to Investment liberalisation – Most-favoured-nation treatment and Cross-border trade in services – Most-favoured-nation treatment:

In **BG**: Full national treatment on the establishment and operation of companies, as well as on the supply of services, may be extended only to companies established in, and citizens of, the countries with whom preferential arrangements have been or will be concluded (part of CPC 861)

In **LT**: Attorneys from foreign countries can participate as advocates in court only in accordance with international agreements (part of CPC 861), including specific provisions regarding representation before courts.

#### **(b) Accounting and bookkeeping services (CPC 8621 other than auditing services, 86213, 86219, 86220)**

With respect to Cross-border trade in services – Market access:

In **HU**: Cross-border activities for accounting and bookkeeping.

**Existing measures:**

**HU:** Act C of 2000; and Act LXXV of 2007.

**(c) Auditing services (CPC – 86211, 86212 other than accounting and bookkeeping services)**

With respect to Cross-border trade in services - National treatment:

In **BG:** An independent financial audit shall be implemented by registered auditors who are members of the Institute of the Certified Public Accountants. Subject to reciprocity, the Institute of the Certified Public Accountants shall register an audit entity of the United Kingdom or of a third country upon the latter furnishing proof that:

(a) three-fourths of the members of the management bodies and the registered auditors carrying out audit on behalf of the entity meet requirements equivalent to those for Bulgarian auditors and have passed successfully the examinations for it;

(b) the audit entity carries out independent financial audit in accordance with the requirements for independence and objectivity; and

(c) the audit entity publishes on its website an annual transparency report or performs other equivalent requirements for disclosure in case it audits public-interest entities.

**Existing Measures:**

**BG:** Independent Financial Audit Act.

With respect to Investment liberalisation – Market access, National treatment, Senior management and boards of directors:

In **CZ:** Only a legal person in which at least 60 per cent of capital interests or voting rights are reserved to nationals of the Czech Republic or of the Member States of the European Union is authorised to carry out audits in the Czech Republic.

**Existing Measures:**

**CZ:** Law of 14 April 2009 no. 93/2009 Coll., on Auditors.

With respect to Cross-border trade in services – Market access:

In **HU:** Cross-border supply of auditing services.

**Existing Measures:**

Act C of 2000; and Act LXXV of 2007.

In **PT:** Cross-border supply of auditing services.

**(d) Architecture and urban planning services (CPC 8674)**

With respect to Cross-border trade in services – Market access, National treatment:

In **HR:** The cross-border supply of urban planning.

### Reservation No. 3 - Professional services – health related and retail of pharmaceuticals

**Sector:** Health related professional services and retail sales of pharmaceutical, medical and orthopaedic goods, other services provided by pharmacists

**Industry classification:** CPC 63211, 85201, 9312, 9319, 93121

**Type of reservation:** Market access  
National treatment  
Senior management and board of directors  
Performance requirements  
Local presence

**Chapter:** Investment Liberalisation and Cross-Border Trade in Services

#### Description:

The EU reserves the right to adopt or maintain any measure with respect to the following:

**(a) *Medical and dental services; services provided by midwives, nurses, physiotherapists, psychologists and paramedical personnel (CPC 63211, 85201, 9312, 9319, CPC 932)***

With respect to Investment liberalisation – Market access, National treatment, Senior management and boards of directors and Cross-border trade in services – Market access and National treatment:

In **FI:** The supply of all health-related professional services, whether publicly or privately funded, including medical and dental services, services provided by midwives, physiotherapists and paramedical personnel and services provided by psychologists, excluding services provided by nurses (CPC 9312, 93191).

#### **Existing measures:**

**FI:** Laki yksityisestä terveydenhuollosta (Act on Private Health Care) (152/1990).

In **BG:** The supply of all health-related professional services, whether publicly or privately funded, including medical and dental services, services provided by nurses, midwives, physiotherapists and paramedical personnel and services provided by psychologists (CPC 9312, part of 9319).

#### **Existing Measures:**

**BG:** Law for Medical Establishment, Professional Organisation of Medical Nurses, Midwives and Associated Medical Specialists Guild Act.

With respect to Investment liberalisation – Market access, National treatment and Cross-border trade in services – Market access and National treatment:

In **CZ, MT:** The supply of all health-related professional services, whether publicly or privately funded, including the services provided by professionals such as medical doctors, dentists, midwives,

nurses, physiotherapists, paramedics, psychologists, as well as other related services (CPC 9312, part of 9319).

**Existing Measures:**

**CZ:** Act No 296/2008 Coll., on Safeguarding the Quality and Safety of Human Tissues and Cells Intended for Use in Man ("Act on Human Tissues and Cells");

Act No 378/2007 Coll., on Pharmaceuticals and on Amendments to Some Related Acts (Act on Pharmaceuticals);

Act No. 268/2014 Coll. on medical devices and amending Act No 634/2004 Coll. on administrative fees, as subsequently amended;

Act No. 285/2002 Coll., on the Donating, Taking and Transplanting of Tissues and Organs and on Amendment to Certain Acts (Transplantation Act).

Act No. 372/2011 Coll., on health services and on conditions of their provision

Act No. 373/2011 Coll., on specific health services).

With respect to Cross-border trade in services – Market access, National treatment, Local presence:

The **EU**, with the exception of **NL** and **SE**: The supply of all health-related professional services, whether publicly or privately funded, including the services provided by professionals such as medical doctors, dentists, midwives, nurses, physiotherapists, paramedics, and psychologists, requires residency. These services may only be provided by natural persons physically present in the territory of the European Union (CPC 9312, part of 93191).

In **BE**: The cross-border supply whether publicly or privately funded of all health-related professional services, including medical, dental and midwives services and services provided by nurses, physiotherapists, psychologists and paramedical personnel. (part of CPC 85201, 9312, part of 93191)

In **PT**: (Also with respect to Most-favoured nation treatment) Concerning the professions of physiotherapists, paramedical personnel and podiatrists, foreign professionals may be allowed to practice based on reciprocity.

**(b) Veterinary services (CPC 932)**

With respect to Investment liberalisation – Market access, National treatment and Cross-border trade in services –National treatment, Local presence:

In **BG**: A veterinary medical establishment may be established by a natural or a legal person.

The practice of veterinary medicine is only allowed for nationals of the EEA and for permanent residents (physical presence is required for permanent residents).

With respect to Cross-border trade in services – Market access, National treatment:

In **BE, LV**: Cross-border supply of veterinary services.

**(c) Retail sales of pharmaceutical, medical and orthopaedic goods, other services provided by pharmacists (CPC 63211)**

With respect to Investment liberalisation – Market access and Cross-border trade in services – Local presence:

The **EU**, with the exception of **EL, IE, LU, LT and NL**: For restricting the number of suppliers entitled to provide a particular service in a specific local zone or area on a non-discriminatory basis. An economic needs test may therefore be applied, taking into account such factors as the number of and impact on existing establishments, transport infrastructure, population density or geographic spread.

The **EU**, with the exception of **BE, BG, EE, ES, IE and IT**: Mail order is only possible from Member States of the EEA, thus establishment in any of those countries is required for the retail of pharmaceuticals and specific medical goods to the general public in the Union. In **CZ**: Retail sales are only possible from Member States.

In **BE**: The retail sales of pharmaceuticals and specific medical goods are only possible from a pharmacy established in Belgium.

In **BG, EE, ES, IT and LT**: Cross-border retail sales of pharmaceuticals.

In **IE and LT**: Cross-border retail of pharmaceuticals requiring a prescription.

In **PL**: Intermediaries in the trade of medicinal products must be registered and have a place of residence or registered office in the territory of the Republic of Poland.

With respect to Investment liberalisation – Market access, National treatment, Senior management and boards of directors, Performance requirements and Cross-border trade in services – Market access, National treatment:

In **FI**: Retail sales of pharmaceutical products and of medical and orthopaedic goods.

With respect to Investment liberalisation – Market access, National treatment, Senior management and boards of directors and Cross-border trade in services – Market access, National treatment:

In **SE**: Retail sales of pharmaceutical goods and the supply of pharmaceutical goods to the general public.

**Existing measures:**

**AT**: Arzneimittelgesetz (Medication Act), BGBl. Nr. 185/1983 as amended, §§ 57, 59, 59a; and

Medizinproduktegesetz (Medical Products Law), BGBl. Nr. 657/1996 as amended, § 99.

**BE**: Arrêté royal du 21 janvier 2009 portant instructions pour les pharmaciens; and Arrêté royal du 10 novembre 1967 relatif à l'exercice des professions des soins de santé.

**CZ** : Act No. 378/2007 Coll., on Pharmaceuticals, as amended; and Act No. 372/2011 Coll., on Health services, as amended.

**FI**: Lääkelaki (Medicine Act) (395/1987).

**PL:** Pharmaceutical Law, art. 73a (Journal of Laws of 2020, item 944, 1493).

**SE:** Law on trade with pharmaceuticals (2009:336);

Regulation on trade with pharmaceuticals (2009:659); and

The Swedish Medical Products Agency has adopted further regulations, the details can be found at (LVFS 2009:9).

#### **Reservation No. 4 - Business Services - Research and development services**

**Sector:** Research and development services

**Industry classification:** CPC 851, 852, 853

**Type of reservation:** Market access  
National treatment

**Chapter:** Cross-Border Trade in Services

#### **Description:**

The **EU** reserves the right to adopt or maintain any measure with respect to the following:

In **RO**: Cross-border supply of research and development services.

#### **Existing measures:**

**RO**: Governmental Ordinance no. 6 / 2011;

Order of Minister of Education and Research no. 3548 / 2006; and Governmental Decision no. 134 / 2011.

## **Reservation No. 5 - Business Services - Real estate services**

<b>Sector:</b>	Real estate services
<b>Industry classification:</b>	CPC 821, 822
<b>Type of reservation:</b>	Market access National treatment
<b>Chapter:</b>	Cross-Border Trade in Services

### **Description:**

The **EU** reserves the right to adopt or maintain any measure with respect to the following:

In **CZ** and **HU**: Cross-border supply of real estate services.



## **Reservation No. 6 - Business services - Rental or leasing services**

**Sector:** Rental or leasing services without operators

**Industry classification:** CPC 832

**Type of reservation:** Market access  
National treatment

**Chapter:** Cross-Border Trade in Services

### **Description:**

The **EU** reserves the right to adopt or maintain any measure with respect to the following:

In **BE** and **FR**: Cross-border supply of leasing or rental services without operator concerning personal and household goods.

## **Reservation No. 7 - Business Services - Collection agency services and Credit reporting services**

**Sector:** Collection agency services, credit reporting services

**Industry classification:** CPC 87901, 87902

**Type of reservation:** Market access  
National treatment  
Local presence

**Chapter:** Cross-Border Trade in Services

### **Description:**

The **EU** reserves the right to adopt or maintain any measure with respect to the following:

The **EU**, with the exception of **ES**, **LV** and **SE**, with regard to the supply of collection agency services and credit reporting services.

## Reservation No. 8 - Business Services - Placement services

<b>Sector – sub-sector:</b>	Business Services – placement services
<b>Industry classification:</b>	CPC 87201, 87202, 87203, 87204, 87205, 87206, 87209
<b>Type of reservation:</b>	Market access National treatment Senior management and board of directors Local presence
<b>Chapter:</b>	Investment Liberalisation and Cross-Border Trade in Services

### Description:

The **EU** reserves the right to adopt or maintain any measure with respect to the following:

With respect to Investment liberalisation – Market access, National treatment, Senior management and boards of directors and Cross-border trade in services – Market access, National treatment, Local presence:

In the **EU**, with the exception of **HU** and **SE**: Supply services of domestic help personnel, other commercial or industrial workers, nursing and other personnel (CPC 87204, 87205, 87206, 87209).

In **BG, CY, CZ, DE, EE, FI, MT, LT, LV, PL, PT, RO, SI** and **SK**: Executive search services (87201).

In **AT, BG, CY, CZ, EE, FI, LT, LV, MT, PL, PT, RO, SI** and **SK**: The establishment of placement services of office support personnel and other workers (CPC 87202).

In **AT, BG, CY, CZ, DE, EE, FI, MT, LT, LV, PL, PT, RO, SI** and **SK**: Supply services of office support personnel (CPC 87203).

With respect to Cross-border trade in services – Market access, National treatment, Local presence:

In the **EU** with the exception of **BE, HU** and **SE**: The cross-border supply of placement services of office support personnel and other workers (CPC 87202).

In **IE**: The cross-border supply of executive search services (87201).

In **FR, IE, IT** and **NL**: The cross-border supply of services of office personnel (CPC 87203).

With respect to Investment liberalisation – Market access and Cross-border trade in services – Market access

In **DE**: To restrict the number of suppliers of placement services.

In **ES**: To restrict the number of suppliers of executive search services and placement services (CPC 87201, 87202).

In **FR**: These services can be subject to a state monopoly CPC 87202).

In **IT**: To restrict the number of suppliers of supply services of office personnel (87203).

*With respect to Investment liberalisation –Market access, National treatment:*

In **DE**: The Federal Ministry of Labour and Social Affairs may issue a regulation concerning the placement and recruitment of non-European Union and non-EEA personnel for specified professions (CPC 87201, 87202, 87203, 87204, 87205, 87206, 87209).

**Existing measures:**

**AT**: §§97 and 135 of the Austrian Trade Act (Gewerbeordnung), Federal Law Gazette Nr. 194/1994 as amended; and

Temporary Employment Act (Arbeitskräfteüberlassungsgesetz/AÜG), Federal Law Gazette Nr. 196/1988 as amended.

**BG**: Employment Promotion Act, articles 26, 27, 27a and 28.

**CY**: Private Employment Agency Law N. 126(I)/2012 as amended.

**CZ**: Act on Employment (435/2004).

**DE**: Gesetz zur Regelung der Arbeitnehmerüberlassung (AÜG);

Sozialgesetzbuch Drittes Buch (SGB III; Social Code, Book Three) - Employment Promotion;

Verordnung über die Beschäftigung von Ausländerinnen und Ausländern (BeschV; Ordinance on the Employment of Foreigners).

**DK**: §§ 8a – 8f in law decree no. 73 of 17th of January 2014 and specified in decree no. 228 of 7th of March 2013 (employment of seafarers); and Employment Permits Act 2006. S1(2) and (3).

**EL**: Law 4052/2012 (Official Government Gazette 41 A) as amended to some of its provision by the law N.4093/2012 (Official Government Gazette 222 A).

**ES**: Real Decreto-ley 8/2014, de 4 de julio, de aprobación de medidas urgentes para el crecimiento, la competitividad y la eficiencia, artículo 117 (tramitado como Ley 18/2014, de 15 de octubre).

**FI**: Laki julkisesta työvoima-ja yrityspalvelusta (Act on Public Employment and Enterprise Service) (916/2012).

**HR**: Labour Market Act (OG 118/18, 32/20)

Labour Act (OG 93/14, 127/17, 98/19)

Aliens Act (OG 130/11m 74/13, 67/17, 46/18, 53/20)

**IE**: Employment Permits Act 2006. S1(2) and (3).

**IT**: Legislative Decree 276/2003 articles 4, 5.

**LT:** Lithuanian Labour Code of the Republic of Lithuania approved by Law No XII-2603 of 14 September 2016 of the Republic of Lithuania,

The Law on the Legal Status of Aliens of the Republic of Lithuania of 29 April 2004 No. IX-2206 as last amended 03-12-2019 No. [XIII-2582](#)

**LU:** Loi du 18 janvier 2012 portant création de l'Agence pour le développement de l'emploi (Law of 18 January 2012 concerning the creation of an agency for employment development – ADEM).

**MT:** Employment and Training Services Act, (Cap 343) (Articles 23 to 25); and Employment Agencies Regulations (S.L. 343.24).

**PL:** Article 18 of the Act of 20 April 2004 on the promotion of employment and labour market institutions (Dz. U. of 2015, Item. 149, as amended).

**PT:** Decree-Law No 260/2009 of 25 September, as amended by Law No. 5/2014 of 12 February (access and provision of services by placement agencies).

**RO:** Law no. 156/2000 on the protection of Romanian citizens working abroad, republished, and Government Decision no. 384/2001 for approving the methodological norms for applying the Law no. 156/2000, with subsequent amendments;

Ordinance of the Government no. 277/2002, as modified by Government Ordinance No. 790/2004 and Government Ordinance No. 1122/2010; and

Law no.53/2003 - Labour Code, republished, with subsequent amendments and supplement and the Government Decision no 1256/2011 on the operating conditions and authorization procedure for temporary work agency.

**SI:** Labour market regulation act (Official Gazette of RS, No. 80/2010, 21/2013, 63/2013, 55/2017); and Employment, Self-employment and Work of Aliens Act – ZZSDT (Official Gazette of RS, No.

47/2015), ZZSDT-UPB2 (Official Gazette of RS, No. 1 /2018).

**SK:** Act No 5/2004 on Employment Services; and Act No 455/1991 on Trade Licensing.

## Reservation No. 9 - Business Services - Security and investigation services

**Sector – sub-sector:** Business services – security and investigation services

**Industry classification:** CPC 87301, 87302, 87303, 87304, 87305, 87309

**Type of reservation:** Market access  
National treatment  
Senior management and board of directors  
Performance requirements  
Local presence

**Chapter:** Investment Liberalisation and Cross-Border Trade in Services

### Description:

The EU reserves the right to adopt or maintain any measure with respect to the following:

#### **(a) Security services (CPC 87302, 87303, 87304, 87305, 87309)**

With respect to Investment liberalisation – Market access, National treatment, Senior management and boards of directors, Performance requirements and Cross-border trade in services – Market access, National treatment:

In **BG, CY, CZ, EE, ES, LT, LV, MT, PL, RO, SI** and **SK**: The supply of security services.

In **DK, HR** and **HU**: The supply of the following subsectors: guard services (87305) in **HR** and **HU**, security consultation services (87302) in **HR**, airport guard services (part of 87305) in **DK** and armoured car services (87304) in **HU**.

With respect to Investment liberalisation – Market access, National treatment, Senior management and boards of directors and Cross-border trade in services –National treatment, Local presence:

In **BE**: Nationality of a Member State is required for boards of directors of enterprises legal persons supplying guard and security services (87305) as well as consultancy and training relating to security services (87302). The senior management of companies providing guard and security consultancy services required to be resident nationals of a Member State.

In **FI**: Licences to supply security services may be granted only to natural persons resident in the EEA or legal persons established in the EEA.

In **ES**: The cross border supply of security services. Nationality requirements exist for private security personnel.

With respect to Cross-border trade in services – Market access, National treatment:

In **BE, FI, FR** and **PT**: The supply of security services by a foreign provider on a cross-border basis is not allowed. Nationality requirements exist for specialised personnel in **PT** and for managing directors and directors in **FR**.

**Existing measures:**

**BE:** Loi réglementant la sécurité privée et particulière, 2 Octobre 2017

**BG:** Private Security Business Act.

**CZ:** Trade Licensing Act.

**DK:** Regulation on aviation security.

**FI:** Laki yksityisistä turvallisuuspalveluista 282/2002 (Private Security Services Act).

**LT:** Law on security of Persons and Assets 8 July 2004 No. IX-2327.

**LV:** Security Guard Activities Law (Sections 6, 7, 14).

**PL:** Act of 22 August 1997 on the protection of persons and property (Journal of Laws of 2016, item 1432 as amended).

**PT:** Law 34/2013 alterada p/ Lei 46/2019, 16 maio; and Ordinance 273/2013 alterada p/ Portaria 106/2015, 13 abril.

**SI:** Zakon o zasebnem varovanju (Law on private security).

**(b) Investigation services (CPC 87301)**

With respect to Investment liberalisation – Market access, National treatment, Senior management and boards of directors, Performance requirements and Cross-border trade in services – Market access, National treatment, Local presence:

The **EU**, with the exception of **AT and SE**: The supply of investigation services.

With respect to Investment liberalisation - Market access and Cross-border trade in services – Market access:

In **LT** and **PT**: Investigation services are a monopoly reserved to the State.

## Reservation No. 10 - Business Services - Other business services

**Sector – sub-sector:** Business services – other business services (translation and interpretation services, duplicating services, services incidental to energy distribution and services incidental to manufacturing)

**Industry classification:** CPC 87905, 87904, 884, 887

**Type of reservation:** Market access  
National treatment  
Most favoured nation treatment  
Senior management and board of directors  
Performance requirements  
Local presence

**Chapter:** Investment Liberalisation and Cross-Border Trade in Services

### Description:

The EU reserves the right to adopt or maintain any measure with respect to the following:

**(a) Translation and interpretation services (CPC 87905)**

With respect to Cross-border trade in services – Market access, National treatment:

In HR: Cross-border supply of translation and interpretation of official documents.

**(b) Duplicating services (CPC 87904)**

With respect to Cross-border trade in services – Market access, National treatment, Local presence:

In HU: Cross-border supply of duplicating services.

**(c) Services incidental to energy distribution and services incidental to manufacturing (Part of CPC 884, 887 other than advisory and consulting services)**

With respect to Investment liberalisation – Market access, National treatment, Senior management and boards of directors and Cross-border trade in services – Market access, National treatment, Local presence:

In HU: Services incidental to energy distribution, and cross-border supply of services incidental to manufacturing, with the exception of advisory and consulting services relating to these sectors.

**(d) Maintenance and repair of vessels, rail transport equipment and aircraft and parts thereof (part of CPC 86764, CPC 86769, CPC 8868)**

With respect to Cross-border trade in services – Market access, National treatment, Local presence:

In EU, with the exception of DE, EE and HU: The cross-border supply of maintenance and repair services of rail transport equipment.



In **EU**, with the exception of **CZ, EE, HU, LU** and **SK**: Cross-border supply of maintenance and repair services of inland waterway transport vessels.

In **EU**, with the exception of **EE, HU** and **LV**: The cross-border supply of maintenance and repair services of maritime vessels.

In **EU**, with the exception of **AT, EE, HU, LV**, and **PL**: The cross-border supply of maintenance and repair services of aircraft and parts thereof (part of CPC 86764, CPC 86769, CPC 8868).

In **EU**: The cross-border supply of services of statutory surveys and certification of ships.

**Existing measures:**

**EU**: Regulation (EC) 391/2009 of the European Parliament and the Council of 23 April 2009 on common rules and standards for ship inspection and survey organisations.

**(e) Other business services related to aviation**

With respect to Investment liberalisation – Most-favoured-nation treatment and Cross-border trade in services – Most-favoured-nation treatment:

The **EU**: According differential treatment to a third country pursuant to existing or future bilateral agreements relating to the following services:

- (a) the selling and marketing of air transport services;
- (b) computer reservation system (CRS) services;
- (c) maintenance and repair of aircrafts and parts,
- (d) rental or leasing of aircraft without crew

With respect to Investment liberalisation - Market access, National treatment, Performance requirements, Senior management and boards of director, and Cross-border trade in services – Market access, National treatment, Local presence:

In **DE, FR**: Aerial fire-fighting, flight training, spraying, surveying, mapping, photography, and other airborne agricultural, industrial and inspection services.

In **FI, SE**: Aerial fire-fighting

## **Reservation No. 11 – Telecommunication**

<b>Sector:</b>	Satellite broadcast transmission services
<b>Industry classification:</b>	Part of CPC 861, part of 87902, 862, 863, 8671, 8672, 8673, 8674, part of 879
<b>Type of reservation:</b>	Market access National treatment
<b>Chapter:</b>	Investment Liberalisation and Cross-Border Trade in Services

### **Description:**

The **EU** reserves the right to adopt or maintain any measure with respect to the following:

In **BE**: Satellite broadcast transmission services.

## **Reservation No. 12 – Construction**

**Sector:** Construction services

**Industry classification:** CPC 51

**Type of reservation:** Market access  
National treatment

**Chapter:** Investment Liberalisation and Cross-Border Trade in Services

### **Description:**

The **EU** reserves the right to adopt or maintain any measure with respect to the following:

In **LT**: The right to prepare design documentation for construction works of exceptional significance is only given to a design enterprise registered in Lithuania or a foreign design enterprise which has been approved by an institution authorised by the Government for those activities. The right to perform technical activities in the main areas of construction may be granted to a non-Lithuanian person who has been approved by an institution authorised by the Government of Lithuania.

## Reservation No. 13 - Distribution services

<b>Sector:</b>	Distribution services
<b>Industry classification:</b>	CPC 62117, 62251, 8929, part of 62112, 62226, part of 631
<b>Type of reservation:</b>	Market access National treatment Senior management and board of directors Performance requirements
<b>Chapter:</b>	Investment Liberalisation and Cross-Border Trade in Services

### Description:

The EU reserves the right to adopt or maintain any measure with respect to the following:

#### ***(a) Distribution of pharmaceuticals***

With respect to Cross-border trade in services – Market access, National treatment:

In **BG**: Cross-border wholesale distribution of pharmaceuticals (CPC 62251).

With respect to Investment liberalisation - Market access, National treatment, Performance requirements, Senior management and boards of director, and Cross-border trade in services – Market access, National treatment:

In **FI**: Distribution of pharmaceutical products (CPC 62117, 62251, 8929).

#### ***Existing measures:***

**BG**: Law on Medicinal Products in Human Medicine; Law on Medical Devices.

**FI**: Lääkelaki (Medicine Act) (395/1987).

#### ***(b) Distribution of alcoholic beverages***

In **FI**: Distribution of alcoholic beverages (part of CPC 62112, 62226, 63107, 8929).

#### ***Existing measures:***

**FI**: Alkoholilaki (Alcohol Act) (1102/2017).

With respect to Investment liberalisation – Market access and Cross-border trade in services – Market access:

In **SE**: Imposing a monopoly on retail sales of liquor, wine and beer (except non-alcoholic beer). Currently Systembolaget AB has such governmental monopoly on retail sales of liquor, wine and beer (except non-alcoholic beer). Alcoholic beverages are beverages with an alcohol content over 2.25 per cent per volume. For beer, the limit is an alcohol content over 3.5 per cent per volume (part of CPC 631).

**Existing measures:**

**SE:** The Alcohol Act (2010:1622).

**(c) Other distribution (part of CPC 621, CPC 62228, CPC 62251, CPC 62271, part of CPC 62272, CPC 62276, CPC 63108, part of CPC 6329)**

With respect to Cross-border trade in services – Market access, National treatment:

In **BG:** Wholesale distribution of chemical products, precious metals and stones, medical substances and products and objects for medical use; tobacco and tobacco products and alcoholic beverages.

Bulgaria reserves the right to adopt or maintain any measure with respect to the services provided by commodity brokers.

**Existing measures:**

In **BG:** Law on Medicinal Products in Human Medicine;

Law on Medical Devices;

Law of Veterinary Activity;

Law for Prohibition of Chemical Weapons and for Control over Toxic Chemical Substances and Their Precursors;

Law for Tobacco and Tobacco Products. Law on excise duties and tax warehouses and Law on wine and spirits.

## Reservation No. 14 - Education services

<b>Sector:</b>	Education services
<b>Industry classification:</b>	CPC 92
<b>Type of reservation:</b>	Market access National treatment Senior management and board of directors Performance requirements Local presence
<b>Chapter:</b>	Investment Liberalisation and Cross-Border Trade in Services

### Description:

The **EU** reserves the right to adopt or maintain any measure with respect to the following:

With respect to Investment liberalisation - Market access, National treatment, Performance requirements, Senior management and boards of director, and Cross-border trade in services – Market access, National treatment, Local presence:

The **EU**: Educational services which receive public funding or State support in any form. Where the supply of privately funded education services by a foreign provider is permitted, participation of private operators in the education system may be subject to concession allocated on a non-discriminatory basis.

The **EU**, with the exception of **CZ, NL, SE** and **SK**: With respect to the supply of privately funded other education services, which means other than those classified as being primary, secondary, higher and adult education services (CPC 929).

In **CY, FI, MT** and **RO**: The supply of privately funded primary, secondary, and adult education services (CPC 921, 922, 924).

In **AT, BG, CY, FI, MT** and **RO**: The supply of privately funded higher education services (CPC 923).

In **CZ** and **SK**: The majority of the members of the board of directors of an establishment providing privately funded education services must be nationals of that country (CPC 921, 922, 923 for SK other than 92310, 924).

In **SI**: Privately funded elementary schools may be founded by Slovenian natural or legal persons only. The service supplier must establish a registered office or a branch. The majority of the members of the board of directors of an establishment providing privately funded secondary or higher education services must be Slovenian nationals (CPC 922, 923).

In **SE**: Educational services suppliers that are approved by public authorities to provide education. This reservation applies to privately funded educational services suppliers with some form of State support, inter alia educational service suppliers recognised by the State, educational services suppliers under State supervision or education which entitles to study support (CPC 92).

In **SK**: EEA residency is required for suppliers of all privately funded education services other than post-secondary technical and vocational education services. An economic needs test may apply and the number of schools being established may be limited by local authorities (CPC 921, 922, 923 other than 92310, 924).

With respect to Cross-border trade in services – Market access, National treatment, Local presence:

In **BG, IT** and **SI**: To restrict the cross-border supply of privately funded primary education services (CPC 921).

In **BG** and **IT**: To restrict the cross-border supply of privately funded secondary education services (CPC 922).

In **AT**: To restrict the cross-border supply of privately funded adult education services by means of radio or television broadcasting (CPC 924).

**Existing measures:**

**BG**: Public Education Act, article 12;

Law for the Higher Education, paragraph 4 of the additional provisions; and Vocational Education and Training Act, article 22.

**FI**: Perusopetuslaki (Basic Education Act) (628/1998);

Lukiolaki (General Upper Secondary Schools Act) (629/1998);

Laki ammatillisesta koulutuksesta (Vocational Training and Education Act) (630/1998);

Laki ammatillisesta aikuiskoulutuksesta (Vocational Adult Education Act) (631/1998);

Ammattikorkeakoululaki (Polytechnics Act) (351/2003); and Yliopistolaki (Universities Act) (558/2009).

**IT**: Royal Decree 1592/1933 (Law on secondary education);

Law 243/1991 (Occasional public contribution for private universities);

Resolution 20/2003 of CNVSU (Comitato nazionale per la valutazione del sistema universitario); and

Decree of the President of the Republic (DPR) 25/1998.

**SK**: Act 245/2008 on education;

Act 131/2002 on Universities; and

Act 596/2003 on State Administration in Education and School Self- Administration.

**Reservation No. 15 - Environmental services**

**Sector – sub-sector:** Environmental services – waste and soil management

**Industry classification:** CPC 9401, 9402, 9403, 94060

**Type of reservation:** Market access

**Chapter:** Cross-Border Trade in Services

**Description:**

The **EU** reserves the right to adopt or maintain any measure with respect to the following:

In **DE**: The supply of waste management services other than advisory services, and with respect to services relating to the protection of soil and the management of contaminated soils, other than advisory services.



## Reservation No. 16 - Financial services

<b>Sector:</b>	Financial services
<b>Industry classification:</b>	Not applicable
<b>Type of reservation:</b>	Market access National treatment Most favoured nation treatment Senior management and board of directors Local presence
<b>Chapter:</b>	Investment Liberalisation and Cross-Border Trade in Services

### Description:

The EU reserves the right to adopt or maintain any measure with respect to the following:

#### **(a) All Financial Services**

With respect to Investment liberalisation – Most favoured nation treatment and Cross-border trade in services – Most favoured nation treatment:

The EU: According differential treatment to an investor or a financial services supplier of a third country pursuant to any bilateral or multilateral international investment treaty or other trade agreement.

With respect to Investment liberalisation – Market access

The EU: the right to require a financial service supplier, other than a branch, when establishing in a Member State to adopt a specific legal form, on a non-discriminatory basis.

With respect to Cross-border trade in services – Market access, National treatment, Local presence

The EU: the right to adopt or maintain any measure with respect to the cross-border supply of all financial services other than:

In EU (except for BE, CY, EE, LT, LV, MT, PL, RO, SI):

- (i) direct insurance services (including co-insurance) and direct insurance intermediation for the insurance of risks relating to:
  - a. maritime transport and commercial aviation and space launching and freight (including satellites), with such insurance to cover any or all of the following: the goods being transported, the vehicle transporting the goods, and any liability deriving therefrom; and
  - b. goods in international transit;
- (ii) reinsurance and retrocession;

- (iii) services auxiliary to insurance;
- (iv) the provision and transfer of financial information, and financial data processing and related software by suppliers of other financial services; and
- (v) advisory and other auxiliary financial services relating to banking and other financial services as described in point (a)(ii)(L) of the definition of banking and other financial services (excluding insurance) in Article SERVIN.5.38 [Definitions], but not intermediation as described in that point.

**In BE:**

- (i) direct insurance services (including co-insurance) and direct insurance intermediation for the insurance of risks relating to:
  - a. maritime transport and commercial aviation and space launching and freight (including satellites), with such insurance to cover any or all of the following: the goods being transported, the vehicle transporting the goods, and any liability deriving therefrom; and
  - b. goods in international transit;
- (ii) reinsurance and retrocession;
- (iii) services auxiliary to insurance;
- (iv) for the supply of banking and other financial services as described in point (a)(ii)(L) of the definition of banking and other financial services (excluding insurance) in Article SERVIN.5.38 [Definitions] except for the provision and transfer of financial information, and financial data processing and related software by suppliers of other financial services;

**In CY:**

- (i) direct insurance services (including co-insurance) for the insurance of risks relating to:
  - a. maritime transport and commercial aviation and space launching and freight (including satellites), with such insurance to cover any or all of the following: the goods being transported, the vehicle transporting the goods, and any liability deriving therefrom; and
  - b. goods in international transit;
- (ii) Insurance intermediation;
- (iii) Reinsurance and retrocession;
- (iv) Services auxiliary to insurance;
- (v) the trading for own account or for the account of customers, whether on an exchange or an over-the-counter market or otherwise of transferrable securities;
- (vi) the provision and transfer of financial information, and financial data processing and related software by suppliers of other financial services; and

(vii) advisory and other auxiliary financial services, relating to banking and other financial services as described in point (a)(ii)(L) of the definition of banking and other financial services (excluding insurance) in Article SERVIN.5.38 [Definitions], but not intermediation as described in that point.

**In EE:**

- (i) Direct insurance (including co-insurance);
- (ii) Reinsurance and retrocession;
- (iii) Insurance intermediation;
- (iv) Services auxiliary to insurance
- (v) Acceptance of deposits;
- (vi) Lending of all types;
- (vii) Financial leasing;
- (viii) All payment and money transmission services; guarantees and commitments;
- (ix) Trading for own account or for account of customers, whether on an exchange, in an over-the-counter market;
- (x) Participation in issues of all kinds of securities, including underwriting and placement as agent (whether publicly or privately) and provision of services related to such issues;
- (xi) Money broking;
- (xii) Asset management, such as cash or portfolio management, all forms of collective investment management, custodial, depository and trust services;
- (xiii) Settlement and clearing services for financial assets, including securities, derivative products, and other negotiable instruments;
- (xiv) Provision and transfer of financial information, and financial data processing and related software; and
- (xv) Advisory and other auxiliary financial services relating to banking and other financial services as described in point (a)(ii)(L) of the definition of banking and other financial services (excluding insurance) in Article SERVIN.5.38 [Definitions], but not intermediation as described in that point.

**In LT:**

- (i) direct insurance services (including co-insurance) for the insurance of risks relating to:
  - a. maritime transport and commercial aviation and space launching and freight (including satellites), with such insurance to cover any or all of the following: the goods being transported, the vehicle transporting the goods, and any liability deriving therefrom; and

- b. goods in international transit;
- (ii) reinsurance and retrocession;
- (iii) services auxiliary to insurance;
- (iv) acceptance of deposits;
- (v) lending of all types;
- (vi) financial leasing;
- (vii) all payment and money transmission services; guarantees and commitments;
- (viii) trading for own account or for account of customers, whether on an exchange, in an over-the-counter market;
- (ix) participation in issues of all kinds of securities, including underwriting and placement as agent (whether publicly or privately) and provision of services related to such issues;
- (x) money broking;
- (xi) asset management, such as cash or portfolio management, all forms of collective investment management, custodial, depository and trust services;
- (xii) settlement and clearing services for financial assets, including securities, derivative products, and other negotiable instruments;
- (xiii) provision and transfer of financial information, and financial data processing and related software; and
- (xiv) advisory and other auxiliary financial services relating to banking and other financial services as described in point (a)(ii)(L) of the definition of banking and other financial services (excluding insurance) in Article SERVIN.5.38 [Definitions], but not intermediation as described in that point.

**In LV:**

- (i) direct insurance services (including co-insurance) for the insurance of risks relating to:
  - a. maritime transport and commercial aviation and space launching and freight (including satellites), with such insurance to cover any or all of the following: the goods being transported, the vehicle transporting the goods, and any liability deriving therefrom; and
  - b. goods in international transit;
- (ii) reinsurance and retrocession; and
- (iii) services auxiliary to insurance
- (iv) participation in issues of all kinds of securities, including underwriting and placement as agent (whether publicly or privately) and provision of services related to such issues;

- (v) the provision and transfer of financial information, and financial data processing and related software by suppliers of other financial services; and
- (vi) advisory and other auxiliary financial services relating to banking and other financial services as described in point (a)(ii)(L) of the definition of banking and other financial services (excluding insurance) in Article SERVIN.5.38 [Definitions], but not intermediation as described in that point.

**In MT:**

- (i) direct insurance services (including co-insurance) for the insurance of risks relating to:
  - a. maritime transport and commercial aviation and space launching and freight (including satellites), with such insurance to cover any or all of the following: the goods being transported, the vehicle transporting the goods, and any liability deriving therefrom; and
  - b. goods in international transit;
- (ii) reinsurance and retrocession;
- (iii) services auxiliary to insurance;
- (iv) the acceptance of deposits;
- (v) lending of all types;
- (vi) the provision and transfer of financial information, and financial data processing and related software by suppliers of other financial services; and
- (vii) advisory and other auxiliary financial services relating to banking and other financial services as described in point (a)(ii)(L) of the definition of banking and other financial services (excluding insurance) in Article SERVIN.5.38 [Definitions], but not intermediation as described in that point.

**In PL:**

- (i) direct insurance services (including co-insurance) for the insurance of risks relating to goods in international trade;
- (ii) reinsurance and retrocession of risks relating to goods in international trade;
- (iii) direct insurance services (including co-insurance and retrocession) and direct insurance intermediation for the insurance of risks relating to:
  - a. maritime transport and commercial aviation and space launching and freight (including satellites), with such insurance to cover any or all of the following: the goods being transported, the vehicle transporting the goods, and any liability deriving therefrom; and
  - b. goods in international transit;

- (iv) the provision and transfer of financial information, and financial data processing and related software by suppliers of other financial services; and
- (v) advisory and other auxiliary financial services relating to banking and other financial services as described in point (a)(ii)(L) of the definition of banking and other financial services (excluding insurance) in Article SERVIN.5.38 [Definitions], but not intermediation as described in that point.

**In RO:**

- (i) direct insurance services (including co-insurance) and direct insurance intermediation for the insurance of risks relating to:
  - a. maritime transport and commercial aviation and space launching and freight (including satellites), with such insurance to cover any or all of the following: the goods being transported, the vehicle transporting the goods, and any liability deriving therefrom; and
  - b. goods in international transit;
- (ii) reinsurance and retrocession; and
- (iii) services auxiliary to insurance
- (iv) acceptance of deposits;
- (v) lending of all types;
- (vi) guarantees and commitments;
- (vii) money broking;
- (viii) the provision and transfer of financial information, and financial data processing and related software; and
- (ix) advisory and other auxiliary financial services relating to banking and other financial services as described in point (a)(ii)(L) of the definition of banking and other financial services (excluding insurance) in Article SERVIN.5.38 [Definitions], but not intermediation as described in that point.

**In SI:**

- (i) direct insurance services (including co-insurance) and direct insurance intermediation for the insurance of risks relating to:
- (ii) maritime transport and commercial aviation and space launching and freight (including satellites), with such insurance to cover any or all of the following: the goods being transported, the vehicle transporting the goods, and any liability deriving therefrom; and
- (iii) goods in international transit;
- (iv) reinsurance and retrocession;

- (v) services auxiliary to insurance;
- (vi) lending of all types;
- (vii) the acceptance of guarantees and commitments from foreign credit institutions by domestic legal entities and sole proprietors;
- (viii) the provision and transfer of financial information, and financial data processing and related software by suppliers of other financial services; and
- (ix) advisory and other auxiliary financial services relating to banking and other financial services as described in point(a)(ii)(L) of the definition of banking and other financial services (excluding insurance) in Article SERVIN.5.38 [Definitions], but not intermediation as described in that point.

**(b) Insurance and insurance-related services**

With respect to Cross-border trade in services – Market access, National treatment:

In **BG**: Transport insurance, covering goods, insurance of vehicles as such and liability insurance regarding risks located in the Bulgaria may not be underwritten by foreign insurance companies directly.

In **DE**: If a foreign insurance company has established a branch in Germany, it may conclude insurance contracts in Germany relating to international transport only through the branch established in Germany.

**Existing measures:**

**DE**: Luftverkehrsgesetz (LuftVG); and

Luftverkehrszulassungsordnung (LuftVZO).

With respect to Investment liberalisation – Market access, National treatment and Cross-border trade in services – Market access, National treatment:

In **ES**: Residence is required, or alternatively to have two years of experience, for the actuarial profession.

With respect to Cross-border trade in services – Local presence:

In **FI**: The supply of insurance broker services is subject to a permanent place of business in the EU.

Only insurers having their head office in the European Union or having their branch in Finland may offer direct insurance services, including co-insurance.

**Existing measures:**

**FI**: Laki ulkomaisista vakuutusyhtiöistä (Act on Foreign Insurance Companies) (398/1995);

Vakuutusyhtiölaki (Insurance Companies Act) (521/2008);

Laki vakuutusten tarjoamisesta (Act on Insurance Distribution) (234/2018).

In **FR**: Insurance of risks relating to ground transport may be underwritten only by insurance firms established in the European Union.

**Existing measures:**

**FR**: *Code des assurances*.

In **HU**: Only legal persons of the EU and branches registered in Hungary may supply direct insurance services.

**Existing measures:**

**HU**: *Act LX of 2003*.

In **IT**: Transport insurance of goods, insurance of vehicles and liability insurance regarding risks located in Italy may be underwritten only by insurance companies established in the European Union, except for international transport involving imports into Italy.

Cross-border supply of actuarial services.

**Existing measures:**

**IT**: *Article 29 of the code of private insurance (Legislative decree no. 209 of 7 September 2005), Law 194/1942 on the actuarial profession*.

In **PT**: Air and maritime transport insurance, covering goods, aircraft, hull and liability can be underwritten only by enterprises legal persons of the European Union. Only natural persons of, or enterprises established in, the European Union may act as intermediaries for such insurance business in Portugal.

**Existing measure:**

**PT**: Article 3 of Law 147/2015, Article 8 of Law 7/2019.

With respect to Investment liberalisation – Market access, National treatment

In **SK**: Foreign nationals may establish an insurance company in the form of a joint stock company or may conduct insurance business through their branches having a registered office in the Slovak Republic. The authorisation in both cases is subject to the evaluation of the supervisory authority.

**Existing measures:**

**SK**: *Act 39/2015 on Insurance*.

With respect to Investment liberalisation – Market access, National treatment and Cross-border trade in services – Market access

In **FI**: At least one half of the members of the board of directors and the supervisory board, and the managing director of an insurance company providing statutory pension insurance shall have their place of residence in the EEA, unless the competent authorities have granted an exemption. Foreign insurers cannot obtain a licence in Finland as a branch to carry out statutory pension insurance. At least one auditor shall have his permanent residence in the EEA.



For other insurance companies, residency in the EEA is required for at least one member of the board of directors, the supervisory board and the managing director. At least one auditor shall have his permanent residence in the EEA. The general agent of an insurance company of the United Kingdom must have his place of residence in Finland, unless the company has its head office in the European Union.

**Existing measures:**

**FI:** *Laki ulkomaisista vakuutusyhtiöistä (Act on Foreign Insurance Companies) (398/1995); Vakuutusyhtiölaki (Insurance Companies Act) (521/2008);*

*Laki vakuutusedustuksesta (Act on Insurance Mediation) (570/2005);*

*Laki vakuutusten tarjoamisesta (Act on Insurance Distribution) (234/2018) and*

*Laki työeläkevakuutusyhtiöistä (Act on Companies providing statutory pension insurance) (354/1997).*

**(c) Banking and other Financial Services**

With respect to Investment liberalisation – Market access and Cross-border trade in services – Local presence:

The **EU:** Only legal persons having their registered office in the European Union can act as depositories of the assets of investment funds. The establishment of a specialised management company, having its head office and registered office in the same Member State, is required to perform the activities of management of common funds, including unit trusts, and where allowed under national law, investment companies.

**Existing measures:**

**EU:** *Directive 2009/65/EC of the European Parliament and of the Council of 13 July 2009 on the coordination of laws, regulations and administrative provisions relating to undertakings for collective investment in transferable securities (UCITS); and*

*Directive 2011/61/EU of the European Parliament and of the Council of 8 June 2011 on Alternative Investment Fund Managers (AIFM).*

In **EE:** For acceptance of deposits, requirement of authorisation by the Estonian Financial Supervision Authority and registration under Estonian law as a joint-stock company, a subsidiary or a branch.

**Existing measures:**

**EE:** *Krediiasutuste seadus (Credit Institutions Act) § 206 and §21.*

In **SK:** Investment services can only be provided by management companies which have the legal form of a joint-stock company with equity capital according to the law.

**Existing measures:**

**SK:** *Act 566/2001 on Securities and Investment Services; and Act 483/2001 on Banks.*

With respect to Investment liberalisation –National treatment, Senior Management and Boards of Directors

In **FI**: At least one of the founders, the members of the board of directors, the supervisory board, the managing director of banking services providers and the person entitled to sign the name of the credit institution shall have their permanent residence in the EEA. At least one auditor shall have his permanent residence in the EEA.

**Existing measures:**

*FI: Laki liikepankeista ja muista osakeyhtiömuotoisista luottolaitoksista (Act on Commercial Banks and Other Credit Institutions in the Form of a Limited Company) (1501/2001);*

*Säästöpankkilaki (1502/2001) (Savings Bank Act);*

*Laki osuuspankeista ja muista osuuskuntamuotoisista luottolaitoksista (1504/2001) (Act on Cooperative Banks and Other Credit Institutions in the Form of a Cooperative Bank);*

*Laki hypoteekkiyhdistyksistä (936/1978) (Act on Mortgage Societies);*

*Maksulaitoslaki (297/2010) (Act on Payment Institutions);*

*Laki ulkomaisen maksulaitoksen toiminnasta Suomessa (298/2010) (Act on the Operation of Foreign Payment Institution in Finland); and*

*Laki luottolaitostoiminnasta (Act on Credit Institutions) (121/2007).*

With respect to Investment liberalisation – Market access, National treatment and Cross-border trade in services - Local presence:

In **IT**: Services of "consulenti finanziari" (financial consultant). In providing the activity of door-to-door selling, intermediaries must utilise authorised financial salesmen resident within the territory of a Member State.

**Existing measures:**

*IT: Articles 91-111 of Consob Regulation on Intermediaries (no. 16190 of 29 October 2007).*

With respect to Investment liberalisation – Market access, National treatment, Senior management and boards of directors and Cross-border trade in services – Local presence:

In **LT**: Only banks having their registered office or branch in Lithuania and authorised to provide investment services in the EEA may act as the depositories of the assets of pension funds. At least one head of a bank's administration must speak the Lithuanian language.

**Existing measures:**

*LT: Law on Banks of the Republic of Lithuania of 30 March 2004 No IX-2085, as amended by the Law No XIII-729 of 16 November 2017;*

*Law on Collective Investment Undertakings of the Republic of Lithuania of 4 July 2003 No IX-1709, as amended by the Law No XIII-1872 of 20 December 2018;*

*Law on Supplementary Voluntary Pension Accumulation of the Republic of Lithuania of 3 June 1999 No VIII-1212 (as revised in Law No XII-70 of 20 December 2012);*

*Law on Payments of the Republic of Lithuania of 5 June 2003 No. IX-1596, last amendment 17 of October 2019 Nr. XIII-2488*

*Law on Payment Institutions of the Republic of Lithuania of 10 December 2009 No. XI-549 (new version of the Law: No XIII-1093 of 17 April 2018)*

With respect to Cross-border trade in services – Market access:

In **FI**: For payment services, residency or domicile in Finland may be required.

## Reservation No. 17 - Health and social services

<b>Sector:</b>	Health and social services
<b>Industry classification:</b>	CPC 93, 931, other than 9312, part of 93191, 9311, 93192, 93193, 93199
<b>Type of reservation:</b>	Market access National treatment Most favoured nation treatment Senior management and board of directors Performance requirements Local presence
<b>Chapter:</b>	Investment Liberalisation and Cross-Border Trade in Services

### Description:

The EU reserves the right to adopt or maintain any measure with respect to the following:

**(a) Health services – hospital, ambulance, residential health services (CPC 93, 931, other than 9312, part of 93191, 9311, 93192, 93193, 93199)**

With respect to Investment liberalisation - Market access, National treatment, Performance requirements, Senior management and boards of directors:

The EU: For the supply of all health services which receive public funding or State support in any form.

The EU: For all privately funded health services, other than privately funded hospital, ambulance, and residential health facilities services other than hospital services. The participation of private operators in the privately funded health network may be subject to concession on a non-discriminatory basis. An economic needs test may apply. Main criteria: number of and impact on existing establishments, transport infrastructure, population density, geographic spread, and creation of new employment.

This reservation does not relate to the supply of all health-related professional services, including the services supplied by professionals such as medical doctors, dentists, midwives, nurses, physiotherapists, paramedics, and psychologists, which are covered by other reservations (CPC 931 other than 9312, part of 93191).

In **AT, PL and SI**: The supply of privately funded ambulance services (CPC 93192).

In **BE**: the establishment of privately funded ambulance and residential health facilities services other than hospital services (CPC 93192, 93193).

In **BG, CY, CZ, FI, MT and SK**: The supply of privately-funded hospital, ambulance, and residential health services other than hospital services (CPC 9311, 93192, 93193).

In **FI**: Supply of other human health services (CPC 93199).

**Existing measures:**

**CZ:** Act No. 372/2011 Sb. on Health Care Services and Conditions of Their Provision.

**FI:** Laki yksityisestä terveydenhuollosta (Act on Private Health Care) (152/1990).

With respect to Investment liberalisation – Market access, National treatment, Most-favoured nation treatment, Senior management and boards of directors, Performance requirements:

In **DE:** The supply of the Social Security System of Germany, where services may be provided by different companies or entities involving competitive elements which are thus not "Services carried out exclusively in the exercise of governmental authority". To accord better treatment in the context of a bilateral trade agreement with regard to the supply of health and social services (CPC 93).

With respect to Investment liberalisation – Market access, National treatment:

In **DE:** The ownership of privately funded hospitals run by the German Forces.

To nationalise other key privately funded hospitals (CPC 93110).

In **FR:** To the supply of privately funded laboratory analysis and testing services.

*With respect to Cross-border trade in services – Market access, National treatment:*

In **FR:** The supply of privately funded laboratory analysis and testing services (part of CPC 9311).

**Existing measures:**

**FR:** Code de la Santé Publique

**(b) Health and social services, including pension insurance**

With respect to Cross-border trade in services – Market access, National treatment, Local presence:

The **EU**, with the exception of **HU:** The cross-border supply of health services, social services and activities or services forming part of a public retirement plan or statutory system of social security. This reservation does not relate to the supply of all health-related professional services, including the services provided by professionals such as medical doctors, dentists, midwives, nurses, physiotherapists, paramedics, and psychologists, which are covered by other reservations (CPC 931 other than 9312, part of 93191).

In **HU:** The cross-border supply of all hospital, ambulance, and residential health services other than hospital services, which receive public funding (CPC 9311, 93192, 93193).

**(c) Social services, including pension insurance**

With respect to Investment liberalisation – Market access, National treatment, Senior management and boards of directors, Performance requirements:

The **EU:** The supply of all social services which receive public funding or State support in any form and activities or services forming part of a public retirement plan or statutory system of social security. The participation of private operators in the privately funded social network may be subject to concession on a non-discriminatory basis. An economic needs test may apply. Main criteria:

number of and impact on existing establishments, transport infrastructure, population density, geographic spread, and creation of new employment.

In **BE, CY, DE, DK, EL, ES, FR, IE, IT and PT**: The supply of privately funded social services other than services relating to convalescent and rest houses and old people's homes.

In **CZ, FI, HU, MT, PL, RO, SK, and SI**: The supply of privately funded social services.

In **DE**: The Social Security System of Germany, where services are provided by different companies or entities involving competitive elements and might therefore not fall under the definition of the "Services carried out exclusively in the exercise of governmental authority".

***Existing measures:***

**FI**: Laki yksityisistä sosiaalipalveluista (Private Social Services Act) (922/2011).

**IE**: Health Act 2004 (S. 39); and

Health Act 1970 (as amended –S.61A).

**IT**: Law 833/1978 Institution of the public health system;

Legislative Decree 502/1992 Organisation and discipline of the health field; and Law 328/2000 Reform of social services.

## **Reservation No. 18 - Tourism and travel related services**

**Sector:** Tourist guides services, health and social services

**Industry classification:** CPC 7472

**Type of reservation:** National treatment  
Most favoured nation treatment

**Chapter:** Investment Liberalisation and Cross-Border Trade in Services

### **Description:**

The **EU** reserves the right to adopt or maintain any measure with respect to the following:

With respect to Investment liberalisation –National treatment and Cross-border trade in services – National treatment:

In **FR**: To require nationality of a Member State for the supply of tourist guide services.

With respect to Investment liberalisation – Most-favoured-nation treatment and Cross-border trade in services – Most-favoured-nation treatment:

In **LT**: In so far as the United Kingdom allows nationals of Lithuania to provide tourist guide services, Lithuania will allow nationals of the United Kingdom to provide tourist guide services under the same conditions.

## Reservation No. 19 - Recreational, cultural and sporting services

**Sector:** Recreational, cultural and sporting services

**Industry classification:** CPC 962, 963, 9619, 964

**Type of reservation:** Market access  
National treatment  
Senior management and board of directors  
Performance requirements  
Local presence

**Chapter:** Investment Liberalisation and Cross-Border Trade in Services

### Description:

The EU reserves the right to adopt or maintain any measure with respect to the following:

#### **(a) Libraries, archives, museums and other cultural services (CPC963)**

With respect to Investment liberalisation - Market access, National treatment, Performance requirements, Senior management and boards of director, and Cross-border trade in services – Market access, National treatment, Local presence:

The EU, with the exception of AT and, for investment liberalisation, in LT: The supply of library, archive, museum and other cultural services.

In AT and LT: A licence or concession may be required for establishment.

#### **(b) Entertainment services, theatre, live bands and circus services (CPC 9619, 964 other than 96492)**

With respect to Cross-border trade in services – Market access, National treatment:

The EU, with the exception of AT and SE: The cross-border supply of entertainment services, including theatre, live bands, circus and discotheque services.

With respect to Investment liberalisation - Market access, National treatment, Performance requirements, Senior management and boards of director, and Cross-border trade in services – Market access, National treatment, Local presence:

In CY, CZ, FI, MT, PL, RO, SI and SK: With respect to the supply of entertainment services, including theatre, live bands, circus and discotheque services.

In BG: The supply of the following entertainment services: circus, amusement park and similar attraction services, ballroom, discotheque and dance instructor services, and other entertainment services.

In EE: The supply of other entertainment services except for cinema theatre services.

In LT and LV: The supply of all entertainment services other than cinema theatre operation services.



In **CY, CZ, LV, PL, RO** and **SK**: The cross-border supply of sporting and other recreational services.

**(c) News and press agencies (CPC 962)**

With respect to Investment liberalisation – Market access, National treatment:

In **FR**: Foreign participation in existing companies publishing publications in the French language may not exceed 20 per cent of the capital or of voting rights in the company. The establishment of press agencies of the United Kingdom is subject to conditions set out in domestic regulation. The establishment of press agencies by foreign investors is subject to reciprocity.

**Existing measures:**

**FR**: Ordonnance n° 45-2646 du 2 novembre 1945 portant réglementation provisoire des agences de presse; and Loi n° 86-897 du 1 août 1986 portant réforme du régime juridique de la presse.

*With respect to Cross-border trade in services – Market access:*

In **HU**: For supply of news and press agencies services.

**(d) Gambling and betting services (CPC 96492)**

With respect to Investment liberalisation - Market access, National treatment, Performance requirements, Senior management and boards of director, and Cross-border trade in services – Market access, National treatment, Local presence:

The **EU**: The supply of gambling activities, which involve wagering a stake with pecuniary value in games of chance, including in particular lotteries, scratch cards, gambling services offered in casinos, gambling arcades or licensed premises, betting services, bingo services and gambling services operated by and for the benefit of charities or non-profit-making organisations.

## Reservation No. 20 - Transport services and auxiliary transport services

**Sector:** Transport services

**Type of reservation:** Market access  
National treatment  
Most favoured nation treatment  
Senior management and board of directors  
Performance requirements  
Local presence

**Chapter:** Investment Liberalisation and Cross-Border Trade in Services

### Description:

The EU reserves the right to adopt or maintain any measure with respect to the following:

#### **(a) Maritime transport – any other commercial activity undertaken from a ship**

With respect to Investment liberalisation – Market access, National treatment, Senior management and boards of directors, Performance requirements and Cross-border trade in services – Market access, National treatment:

The EU: The nationality of the crew on a seagoing or non-seagoing vessel.

With respect to Investment liberalisation – Market access, National treatment, Most-favoured nation treatment, Senior management and boards of directors:

The EU, except LV and MT: Only EU natural or legal persons may register a vessel and operate a fleet under the national flag of the state of establishment (applies to all commercial marine activity undertaken from a seagoing ship, including fishing, aquaculture, and services incidental to fishing; international passenger and freight transportation (CPC 721); and services auxiliary to maritime transport).

*With respect to Investment liberalisation – Market access and Cross-border trade in services – Market access:*

In MT: Exclusive rights exist for the maritime link to mainland Europe through Italy with Malta (CPC 7213, 7214, part of 742, 745, part of 749).

With respect to Cross-border trade in services – Market access, National treatment, Local presence:

In SK: Foreign investors must have their principal office in the Slovak Republic in order to apply for a licence enabling them to provide a service (CPC 722).

#### **(b) Auxiliary services to maritime transport**

With respect to Investment liberalisation – Market access, National treatment, Senior management and boards of directors and Cross-border trade in services – Market access, National treatment, Local presence:

The **EU**: The supply of pilotage and berthing services. For greater certainty, regardless of the criteria which may apply to the registration of ships in a Member State of the European Union, the European Union reserves the right to require that only ships registered on the national registers of Member States of the European Union may provide pilotage and berthing services (CPC 7452).

The **EU**, with the exception of **LT** and **LV**: Only vessels carrying the flag of a Member State of the European Union may provide pushing and towing services (CPC 7214).

With respect to Investment liberalisation – Market access and Cross-border trade in services – National treatment, Local presence:

In **LT**: Only juridical persons of Lithuania or juridical persons of a Member State of the

European Union with branches in Lithuania that have a Certificate issued by the Lithuanian Maritime Safety Administration may provide pilotage and berthing, pushing and towing services (CPC 7214, 7452).

With respect to Investment liberalisation – Market access and Cross-border trade in services – Market access, National treatment, Local presence:

In **BE**: Cargo handling services can only be operated by accredited workers, eligible to work in port areas designated by royal decree (CPC 741).

***Existing measures:***

**BE**: Loi du 8 juin 1972 organisant le travail portuaire;

Arrêté royal du 12 janvier 1973 instituant une Commission paritaire des ports et fixant sa dénomination et sa compétence;

Arrêté royal du 4 septembre 1985 portant agrément d'une organisation d'employeur (Anvers);

Arrêté royal du 29 janvier 1986 portant agrément d'une organisation d'employeur (Gand);

Arrêté royal du 10 juillet 1986 portant agrément d'une organisation d'employeur (Zeebrugge);  
Arrêté royal du 1er mars 1989 portant agrément d'une organisation d'employeur (Ostende); and

Arrêté royal du 5 juillet 2004 relatif à la reconnaissance des ouvriers portuaires dans les zones portuaires tombant dans le champ d'application de la loi du 8 juin 1972 organisant le travail portuaire, tel que modifié.

**(c) *Auxiliary services to inland waterways transport***

With respect to Investment liberalisation – Market access, National treatment, Most-favoured nation treatment, Senior management and boards of directors, Performance requirements and Cross-border trade in services – Market access, National treatment, Local presence, Most favoured-nation treatment:

The **EU**: Services auxiliary to inland waterways transportation.

**(d) *Rail transport and auxiliary services to rail transport***

With respect to Investment liberalisation – Market access, National treatment and Cross-border trade in services – Market access, National treatment, Local presence:

In **EU**: Railway passenger transportation (CPC 7111).

With respect to Investment liberalisation – Market access, and Cross-border trade in services – Market access, Local Presence:

In **EU**: Railway freight transportation (CPC 7112).

In **LT**: Maintenance and repair services of rail transport equipment are subject to a state monopoly (CPC 86764, 86769, part of 8868).

In **SE** (with respect only to Market access): Maintenance and repair services of rail transport equipment are subject to an economic needs test when an investor intends to establish its own terminal infrastructure facilities. Main criteria: space and capacity constraints (CPC 86764, 86769, part of 8868).

***Existing measures:***

**EU**: Directive 2012/34/EU of the European Parliament and of the Council of 21 November 2012 establishing a single European railway area.

**SE**: Planning and Building Act (2010:900).

***(e) Road transport (passenger transportation, freight transportation, international truck transport services) and services auxiliary to road transport***

With respect to Cross-border trade in services – Market access, National treatment, Local presence:

The **EU**: For road transport services covered by Titles I [Transport of goods by road] and II [Transport of passengers by Road] of Heading Three [Road Transport] of Part Two [Trade, transport and fisheries] and Annex ROAD-1 [Transport of goods by road].

With respect to Investment liberalisation – Market access, National treatment, Senior management and boards of directors:

The **EU**: For road transport services covered by Titles I [Transport of goods by road] and II [Transport of passengers by Road] of Heading Three [Road Transport] of Part Two [Trade, transport and fisheries] and Annex ROAD-1 [Transport of goods by road]:

To limit the supply of cabotage within a Member State of the European Union by foreign investors established in another Member State of the European Union (CPC 712).

With respect to Investment liberalisation – Market access, National treatment, Senior management and boards of directors and Cross-border trade in services – Market access, National treatment, Local presence:

The **EU**: For road transport services not covered by Titles I [Transport of goods by road] and II [Transport of passengers by Road] of Heading Three [Road Transport] of Part Two [Trade, transport and fisheries] and Annex ROAD-1 [Transport of goods by road]:

- i) to require establishment and to limit the cross-border supply of road transport services (CPC 712).
- ii) to limit the supply of cabotage within a Member State of the European Union by foreign investors established in another Member State of the European Union (CPC 712).
- iii) an economic needs test may apply to taxi services in the European Union setting a limit on the number of service suppliers. Main criteria: Local demand as provided in applicable laws (CPC 71221).

With respect to Investment liberalisation – Market access:

In **BE**: A maximum number of licences can be fixed by law (CPC 71221).

In **IT**: An economic needs test is applied to limousine services. Main criteria: number of and impact on existing establishments, population density, geographical spread, impact on traffic conditions and creation of new employment.

An economic needs test is applied to intercity bussing services. Main criteria: number of and impact on existing establishments, population density, geographical spread, impact on traffic conditions and creation of new employment.

An economic needs test is applied to the supply of freight transportation services. Main criteria: local demand (CPC 712).

In **BG, DE**: For passenger and freight transportation, exclusive rights or authorisations may only be granted to natural persons of the Union and to legal persons of the Union having their headquarters in the Union. (CPC 712).

In **MT**: For public bus service: The entire network is subject to a concession which includes a Public Service Obligation agreement to cater for certain social sectors (such as students and the elderly) (CPC 712).

With respect to Investment liberalisation – Market access, National treatment,

In **FI**: Authorisation is required to provide road transport services, which is not extended to foreign registered vehicles (CPC 712).

With respect to Investment liberalisation – Market access, National treatment:

In **FR**: The supply of intercity bussing services (CPC 712).

With respect to Investment liberalisation – Market access:

In **ES**: For passenger transportation, an economic needs test applies to services provided under CPC 7122. Main criteria: local demand. An economic needs test applies for intercity bussing services. Main criteria: number of and impact on existing establishments, population density, geographical spread, impact on traffic conditions and creation of new employment.

In **SE**: Maintenance and repair services of road transport equipment are subject to an economic needs test when a supplier intends to establish its own terminal infrastructure facilities. Main criteria: space and capacity constraints (CPC 6112, 6122, 86764, 86769, part of 8867).

In **SK**: For freight transportation, an economic needs test is applied. Main criteria: local demand (CPC 712).

With respect to Cross-border trade in services – Market access:

In **BG**: To require establishment for supporting services to road transport (CPC 744).

**Existing measures:**

**EU**: Regulation (EC) No 1071/2009 of the European Parliament and of the Council of 21 October 2009 establishing common rules concerning the conditions to be complied with to pursue the occupation of road transport operator and repealing Council Directive 96/26/EC; Regulation (EC) No 1072/2009 of the European Parliament and of the Council of 21 October

2009 on common rules for access to the international road haulage market; and

Regulation (EC) No 1073/2009 of the European Parliament and of the Council of 21 October 2009 on common rules for access to the international market for coach and bus services, and amending Regulation (EC) No 561/2006.

**FI**: Laki kaupallisista tavarankuljetuksista tiellä (Act on Commercial Road Transport)

693/2006; Laki liikenteen palveluista (Act on Transport Services) 320/2017;

Ajoneuvolaki (Vehicles Act) 1090/2002

**IT**: Legislative decree 285/1992 (Road Code and subsequent amendments) article 85;

Legislative Decree 395/2000 article 8 (road transport of passengers);

Law 21/1992 (Framework law on non-scheduled public road transport of passengers);

Law 218/2003 article 1 (transport of passenger through rented buses with driver); and Law 151/1981 (framework law on public local transport).

**SE**: Planning and Building Act (2010:900).

**(f) Space transport and rental of space craft**

With respect to Investment liberalisation – Market access, National treatment, Performance requirements, Senior management and boards of directors and Cross-border trade in services – Market access, National treatment, Local presence:

The **EU**: The supply of space transport services and the supply of rental of space craft services (CPC 733, part of 734).

**(g) Most-favoured-nation**

With respect to Investment liberalisation – Most-favoured-nation treatment, and Cross-border trade in services – Most-favoured-nation treatment:

- *Transport (cabotage) other than maritime transport*

In **FI**: According differential treatment to a country pursuant to existing or future bilateral agreements exempting vessels registered under the foreign flag of a specified other country or foreign registered vehicles from the general prohibition from providing cabotage transport (including combined transport, road and rail) in Finland on the basis of reciprocity (part of CPC 711, part of 712, part of 722).

- *Supporting services for maritime transport*

In **BG**: In so far as the United Kingdom allows service suppliers from Bulgaria to supply cargo-handling services and storage and warehouse services in sea and river harbours, including services relating to containers and goods in containers, Bulgaria will allow service suppliers from the United Kingdom to supply cargo-handling services and storage and warehouse services in sea and river harbours, including services relating to containers and goods in containers under the same conditions (part of CPC 741, part of 742).

- *Rental or leasing of vessels*

In **DE**: Chartering-in of foreign ships by consumers resident in Germany may be subject to a condition of reciprocity (CPC 7213, 7223, 83103).

- *Road and rail transport*

The **EU**: To accord differential treatment to a country pursuant to existing or future bilateral agreements relating to international road haulage (including combined transport – road or rail) and passenger transport, concluded between the Union or the Member States and a third country (CPC 7111, 7112, 7121, 7122, 7123). That treatment may:

(a) reserve or limit the supply of the relevant transport services between the contracting Parties or across the territory of the contracting Parties to vehicles registered in each contracting Party<sup>121</sup>; or

(b) provide for tax exemptions for such vehicles.

- *Road transport*

In **BG**: Measures taken under existing or future agreements, which reserve or restrict the supply of these kinds of transportation services and specify the terms and conditions of this supply, including transit permits or preferential road taxes, in the territory of Bulgaria or across the borders of Bulgaria (CPC 7121, 7122, 7123).

In **CZ**: Measures that are taken under existing or future agreements, and which reserve or limit the supply of transport services and specify operating conditions, including transit permits or

---

<sup>121</sup> With regard to Austria the part of the most-favoured-nation treatment exemption regarding traffic rights covers all countries with whom bilateral agreements on road transport or other arrangements relating to road transport exist or may be considered in future.

preferential road taxes of a transport services into, in, across and out of the Czech Republic to the contracting parties concerned (CPC 7121, 7122, 7123).

In **ES**: Authorisation for the establishment of a commercial presence in Spain may be refused to service suppliers whose country of origin does not accord effective market access to service suppliers of Spain (CPC 7123).

***Existing measures:***

Ley 16/1987, de 30 de julio, de Ordenación de los Transportes Terrestres.

In **HR**: Measures applied under existing or future agreements on international road transport and which reserve or limit the supply of transport services and specify operating conditions, including transit permits or preferential road taxes of transport services into, in, across and out of Croatia to the parties concerned (CPC 7121, 7122, 7123).

In **LT**: Measures that are taken under bilateral agreements and which set the provisions for transport services and specify operating conditions, including bilateral transit and other transport permits for transport services into, through and out of the territory of Lithuania to the contracting parties concerned, and road taxes and levies (CPC 7121, 7122, 7123).

In **SK**: Measures that are taken under existing or future agreements, and which reserve or limit the supply of transport services and specify operating conditions, including transit permits or preferential road taxes of a transport services into, in, across and out of the Slovak Republic to the contracting parties concerned (CPC 7121, 7122, 7123).

- *Rail transport*

In **BG, CZ** and **SK**: For existing or future agreements, and which regulate traffic rights and operating conditions, and the supply of transport services in the territory of Bulgaria, the Czech Republic and Slovakia and between the countries concerned. (CPC 7111, 7112).

- *Air transport - Services auxiliary to air transport*

The **EU**: According differential treatment to a third country pursuant to existing or future bilateral agreements relating to ground-handling services.

- *Road and rail transport*

In **EE**: when according differential treatment to a country pursuant to existing or future bilateral agreements on international road transport (including combined transport-road or rail), reserving or limiting the supply of a transport services into, in, across and out of Estonia to the contracting Parties to vehicles registered in each contracting Party, and providing for tax exemption for such vehicles (part of CPC 711, part of 712, part of 721).

- *All passenger and freight transport services other than maritime and air transport*

In **PL**: In so far as the United Kingdom allows the supply of transport services into and across the territory of the United Kingdom by passenger and freight transport suppliers of Poland, Poland will allow the supply of transport services by passenger and freight transport suppliers of the United Kingdom into and across the territory of Poland under the same conditions.



## Reservation No. 21 - Agriculture, fishing and water

**Sector:** Agriculture, hunting, forestry; fishing, aquaculture, services incidental to fishing; collection, purification and distribution of water

**Industry classification:** ISIC Rev. 3.1 011, ISIC Rev. 3.1 012, ISIC Rev. 3.1 013, ISIC Rev. 3.1 014, ISIC Rev. 3.1 015, CPC 8811, 8812, 8813 other than advisory and consultancy services; ISIC Rev. 3.1 0501, 0502, CPC 882

**Type of reservation:** Market access  
National treatment  
Most favoured nation treatment  
Senior management and board of directors  
Performance requirements  
Local presence

**Chapter:** Investment Liberalisation and Cross-Border Trade in Services

### Description:

The EU reserves the right to adopt or maintain any measure with respect to the following:

#### **(a) Agriculture, hunting and forestry**

With respect to Investment liberalisation – Market access, National treatment:

In **HR:** Agricultural and hunting activities.

In **HU:** Agricultural activities (ISIC Rev. 3.1 011, 3.1 012, 3.1 013, 3.1 014, 3.1 015, CPC 8811, 8812, 8813 other than advisory and consultancy services).

#### **Existing measures:**

**HR:** Agricultural Land Act (OG 20/18, 115/18, 98/19)

#### **(b) Fishing, aquaculture and services incidental to fishing (ISIC Rev. 3.1 0501, 0502, CPC 882)**

With respect to Investment liberalisation – Market access, National treatment, Senior management and boards of directors, Performance requirements, Most-favoured-nation treatment and Cross-border trade in services – Market access, National treatment, Most-favoured-nation treatment, Local presence:

The EU:

1. In particular within the framework of the Common Fisheries Policy, and of fishing agreements with a third country, access to and use of the biological resources and fishing grounds situated in maritime waters coming under the sovereignty or the jurisdiction of Member States, or entitlements for fishing under a Member State fishing licence, including:

- (a) regulating the landing of catches by vessels flying the flag of the United Kingdom or a third country with respect to the quotas allocated to them or, only with respect to vessels flying the flag of a Member State, requiring that a proportion of the total catch is landed in Union ports;
  - (b) determining a minimum size for a company in order to preserve both artisanal and coastal fishing vessels;
  - (c) according differential treatment pursuant to existing or future bilateral agreements relating to fisheries; and
  - (d) requiring the crew of a vessel flying the flag of a Member State to be nationals of Member States.
2. A fishing vessel's entitlement to fly the flag of a Member State only if:
- (a) it is wholly owned by:
    - (i) companies incorporated in the Union; or
    - (ii) Member State nationals;
  - (b) its day-to-day operations are directed and controlled from within the Union; and
  - (c) any charterer, manager or operator of the vessel is a company incorporated in the Union or a national of a Member State.
3. A commercial fishing licence granting the right to fish in the territorial waters of a Member State may only be granted to vessels flying the flag of a Member State.
4. The establishment of marine or inland aquaculture facilities.
5. Point 1 (a), (b), (c) (other than with respect to most-favoured nation treatment) and (d); point 2 (a) (i), (b) and (c) and point 3 only apply to measures which are applicable to vessels or to enterprises irrespective of the nationality of their beneficial owners.

With respect to Investment liberalisation – Market access:

In **FR**: Nationals of non-European Union countries cannot participate in French maritime State property for fish, shellfish or algae farming.

With respect to Investment liberalisation – Market access, National treatment, Most-favoured nation treatment and Cross-border trade in services – Market access, National treatment:

In **BG**: The taking of marine and river-living resources, performed by vessels in the internal marine waters, and the territorial sea of Bulgaria, shall be performed by vessels flying the flag of Bulgaria. A foreign ship may not engage in commercial fishing in the exclusive economic zone save on the basis of an agreement between Bulgaria and the flag state. While passing through the exclusive economic zone, foreign fishing ships may not maintain their fishing gear in operational mode.

**(c) *Collection, purification and distribution of water***

With respect to Investment liberalisation – Market access, National treatment and Cross-border trade in services – Market access, National treatment, Local presence:

The **EU**: For activities, including services relating to the collection, purification and distribution of water to household, industrial, commercial or other users, including the supply of drinking water, and water management.

## Reservation No. 22 - Energy related activities

<b>Sector:</b>	Production of energy and related services
<b>Industry classification:</b>	ISIC Rev. 3.1 10, 1110, 12, 120, 1200, 13, 14, 232, 233, 2330, 40, 401, 4010, 402, 4020, part of 4030, CPC 613, 62271, 63297, 7131, 71310, 742, 7422, part of 88, 887.
<b>Type of reservation:</b>	Market access National treatment Senior management and board of directors Performance requirements Local presence
<b>Chapter:</b>	Investment Liberalisation and Cross-Border Trade in Services

### Description:

The **EU** reserves the right to adopt or maintain any measure with respect to the following:

**(a) Energy services – general (ISIC Rev. 3.1 10, 1110, 13, 14, 232, 40, 401, 402, part of 403, 41; CPC 613, 62271, 63297, 7131, 742, 7422, 887 (other than advisory and consulting services))**

With respect to Investment liberalisation – Market access, National treatment, Senior management and boards of directors, Performance requirements and Cross-border trade in services – Market access, National treatment, Local presence:

The **EU**: Where a Member State permits foreign ownership of a gas or electricity transmission system, or an oil and gas pipeline transport system, with respect to enterprises of the United Kingdom controlled by natural or legal persons of a third country which accounts for more than 5 per cent of the Union's oil, natural gas or electricity imports, in order to guarantee the security of the energy supply of the Union as a whole, or of an individual Member State. This reservation does not apply to advisory and consultancy services provided as services incidental to energy distribution.

This reservation does not apply to **HR, HU** and **LT** (for **LT**, only CPC 7131) with regard to the pipeline transport of fuels, nor to **LV** with regard to services incidental to energy distribution, nor to **SI** with regard to services incidental to the distribution of gas (ISIC Rev. 3.1 401, 402, CPC 7131, 887 other than advisory and consultancy services).

In **CY**: For the manufacture of refined petroleum products in so far as the investor is controlled by a natural or juridical person of a third country which accounts for more than 5 per cent of the Union's oil or natural gas imports, as well as to the manufacture of gas, distribution of gaseous fuels through mains on own account, the production, transmission and distribution of electricity, the pipeline transportation of fuels, services incidental to electricity and natural gas distribution other than advisory and consulting services, wholesale services of electricity, retailing services of motor fuel, electricity and non-bottled gas. Nationality and residency conditions applies for electricity related services. (ISIC Rev. 3.1 232, 4010, 4020, CPC 613, 62271, 63297, 7131, and 887 other than advisory and consulting services)

In **FI**: The transmission and distribution networks and systems of energy and of steam and hot water.

In **FI**: The quantitative restrictions in the form of monopolies or exclusive rights for the importation of natural gas, and for the production and distribution of steam and hot water. Currently, natural monopolies and exclusive rights exist (ISIC Rev. 3.1 40, CPC 7131, 887 other than advisory and consultancy services).

In **FR**: The electricity and gas transmission systems and oil and gas pipeline transport (CPC 7131).

With respect to Investment liberalisation – Market access, National treatment, Senior management and boards of directors and Cross-border trade in services – Market access, National treatment, Local presence:

In **BE**: The energy distribution services, and services incidental to energy distribution (CPC 887 other than consultancy services).

With respect to Investment liberalisation – Market access, National treatment and Cross-border trade in services –National treatment, Local presence:

In **BE**: For energy transmission services, regarding the types of legal entities and to the treatment of public or private operators to whom **BE** has conferred exclusive rights. Establishment is required within the Union (ISIC Rev. 3.1 4010, CPC 71310).

In **BG**: For services incidental to energy distribution (part of CPC 88).

In **PT**: For the production, transmission and distribution of electricity, the manufacturing of gas, the pipeline transportation of fuels, wholesale services of electricity, retailing services of electricity and non-bottled gas, and services incidental to electricity and natural gas distribution. Concessions for electricity and gas sectors are assigned only to limited companies with their headquarters and effective management in **PT** (ISIC Rev. 3.1 232, 4010, 4020, CPC 7131, 7422, 887 other than advisory and consulting services).

In **SK**: An authorisation is required for the production, transmission and distribution of electricity, manufacture of gas and distribution of gaseous fuels, production and distribution of steam and hot water, pipeline transportation of fuels, wholesale and retail of electricity, steam and hot water, and services incidental to energy distribution, including services in the area of energy efficiency, energy savings and energy audit. An economic needs test is applied and the application may be denied only if the market is saturated. For all those activities, an authorisation may only be granted to a natural person with permanent residency in the EEA or a legal person of the EEA.

With respect to Investment liberalisation – Market access, National treatment:

In **BE**: With the exception of the mining of metal ores and other mining and quarrying, enterprises controlled by natural or legal persons of a third country which accounts for more than 5 per cent of the European Union's oil or natural gas or electricity imports may be prohibited from obtaining control of the activity. Incorporation is required (no branching) (ISIC Rev. 3.1 10, 1110, 13, 14, 232, part of 4010, part of 4020, part of 4030).

***Existing measures:***

**EU**: Directive 2009/72/EC of the European Parliament and of the Council of 13 July 2009 concerning common rules for the internal market in electricity and repealing Directive

2003/54/EC; and

Directive 2009/73/EC of the European Parliament and of the Council of 13 July 2009 concerning common rules for the internal market in natural gas and repealing Directive 2003/55/EC.

**BG:** Energy Act.

**CY:** The Regulation of the Electricity Market Laws of 2003 Law 122(I)/2003 as amended;

The Regulation of the Gas Market Laws of 2004, Law 183(I)/2004 as amended;

The Petroleum (Pipelines) Law, Chapter 273;

The Petroleum Law Chapter 272 as amended; and

The Petroleum and Fuel Specifications Laws of 2003, Law 148(I)/2003 as amended. .

**FI:** Maakaasumarkkinalaki (Natural Gas Market Act) (508/2000); and Sähkömarkkinalaki (Electricity Market Act) (386/1995). Maakaasumarkkinalaki (Natural Gas Market Act) (587/2017)

**FR:** Code de l'énergie.

**PT:** Decree-Law 230/2012 and Decree-Law 231/2012, 26 October - Natural Gas; Decree-Law 215-A/2012, and Decree-Law 215-B/2012, 8 October – Electricity; and Decree-Law 31/2006, 15 February – Crude oil/Petroleum products.

**SK:** Act 51/1988 on Mining, Explosives and State Mining Administration;

Act 569/2007 on Geological Works;

Act 251/2012 on Energy; and Act 657/2004 on Thermal Energy.

**(b) Electricity (ISIC Rev. 3.1 40, 401; CPC 62271, 887 (other than advisory and consulting services))**

With respect to Investment liberalisation – Market access, National treatment, Senior management and boards of directors, Performance requirements and Cross-border trade in services – Market access, National treatment:

In **FI:** The importation of electricity. With respect to cross-border trade, the wholesale and retail of electricity.

In **FR:** Only companies where 100 per cent of the capital is held by the French State, by another public sector organisation or by Electricité de France (EDF), may own and operate electricity transmission or distribution systems.

With respect to Investment liberalisation – Market access, National treatment and Cross-border trade in services – Market access, National treatment:

In **BG:** For the production of electricity and the production of heat.

In **PT:** The activities of electricity transmission and distribution are carried out through exclusive concessions of public service.

With respect to Investment liberalisation – Market access, National treatment:

In **BE**: An individual authorisation for the production of electricity of a capacity of 25 MW or above requires establishment in the Union, or in another State which has a similar regime to that enforced by Directive 96/92/EC of the European Parliament and of the Council of 19 December 1996 concerning common rules for the internal market in electricity in place, and where the company has an effective and continuous link with the economy.

The production of electricity within the offshore territory of **BE** is subject to concession and a joint venture obligation with a legal person of the Union, or with a legal person of a country having a similar regime to that of Directive 2003/54/EC of the European Parliament and of the Council of 26 June 2003 concerning common rules for the internal market in electricity and repealing Directive 96/92/EC, particularly with regard to conditions relating to the authorisation and selection.

Additionally, the legal person should have its central administration or its head office in a Member State of the European Union or a country meeting the above criteria, where it has an effective and continuous link with the economy.

The construction of electrical power lines which link offshore production to the transmission network of Elia requires authorisation and the company must meet the previously specified conditions, except for the joint venture requirement.

With respect to Cross-border trade in services – National treatment:

In **BE**: An authorisation is necessary for the supply of electricity by an intermediary having customers established in **BE** who are connected to the national grid system or to a direct line whose nominal voltage is higher than 70,000 volts. That authorisation may only be granted to a natural or legal person of the EEA.

With respect to Investment liberalisation – Market access:

In **FR**: For the production of electricity.

**Existing measures:**

**BE**: Arrêté Royal du 11 octobre 2000 fixant les critères et la procédure d'octroi des autorisations individuelles préalables à la construction de lignes directes;

Arrêté Royal du 20 décembre 2000 relatif aux conditions et à la procédure d'octroi des concessions domaniales pour la construction et l'exploitation d'installations de production d'électricité à partir de l'eau, des courants ou des vents, dans les espaces marins sur lesquels la Belgique peut exercer sa juridiction conformément au droit international de la mer; and Arrêté Royal du 12 mars 2002 relatif aux modalités de pose de câbles d'énergie électrique qui pénètrent dans la mer territoriale ou dans le territoire national ou qui sont installés ou utilisés dans le cadre de l'exploration du plateau continental, de l'exploitation des ressources minérales et autres ressources non vivantes ou de l'exploitation d'îles artificielles, d'installations ou d'ouvrages relevant de la juridiction belge.

Arrêté royal relatif aux autorisations de fourniture d'électricité par des intermédiaires et aux règles de conduite applicables à ceux-ci.

Arrêté royal du 12 juin 2001 relatif aux conditions générales de fourniture de gaz naturel et aux conditions d'octroi des autorisations de fourniture de gaz naturel

**FI:** Maakaasumarkkinalaki (Natural Gas Market Act) (508/2000); and Sähkömarkkinalak (Electricity Market Act) 588/2013; Maakaasumarkkinalaki (Natural Gas Market Act) (587/2017)

**FR:** Code de l'énergie.

**PT:** Decree-Law 215-A/2012; and

Decree-Law 215-B/2012, 8 October – Electricity.

**(c) Fuels, gas, crude oil or petroleum products (ISIC Rev. 3.1 232, 40, 402; CPC 613, 62271, 63297, 7131, 71310, 742, 7422, part of 88, 887 (other than advisory and consulting services))**

With respect to Investment liberalisation – Market access, National treatment, Senior management and boards of directors, Performance requirements and Cross-border trade in services – Market access, National treatment:

In **FI:** To prevent control or ownership of a liquefied natural gas (LNG) terminal (including those parts of the LNG terminal used for storage or re-gasification of LNG) by foreign natural or legal persons for energy security reasons.

In **FR:** Only companies where 100 per cent of the capital is held by the French State, by another public sector organisation or by ENGIE, may own and operate gas transmission or distribution systems for reasons of national energy security.

*With respect to Investment liberalisation – Market access, National treatment and Cross-border trade in services – Market access, National treatment:*

In **BE:** For bulk storage services of gas, regarding the types of legal entities and the treatment of public or private operators to whom Belgium has conferred exclusive rights. Establishment is required within the Union for bulk storage services of gas (part of CPC 742).

In **BG:** For pipeline transportation, storage and warehousing of petroleum and natural gas, including transit transmission (CPC 71310, part of CPC 742).

In **PT:** For the cross-border supply of storage and warehousing services of fuels transported through pipelines (natural gas). Also, concessions relating to the transmission, distribution and underground storage of natural gas and the reception, storage and regasification terminal of LNG are awarded through contracts concession, following public calls for tenders (CPC 7131, CPC 7422).

With respect to Cross-border trade in services – Market access, National treatment:

In **BE:** The pipeline transport of natural gas and other fuels is subject to an authorisation requirement. An authorisation may only be granted to a natural or juridical person established in a Member State (in accordance with Article 3 of the AR of 14 May 2002).

Where the authorisation is requested by a company:

- a) the company must be established in accordance with Belgian law, or the law of another Member State, or the law of a third country, which has undertaken commitments to maintain a regulatory framework similar to the common requirements specified in Directive 98/30/EC of the European Parliament and the Council of 22 June 1998 concerning common rules for the internal market in natural gas; and



- b) the company must hold its administrative seat, its principal establishment or its head office within a Member State, or a third country, which has undertaken commitments to maintain a regulatory framework similar to the common requirements specified in Directive 98/30/EC of the European Parliament and the Council of 22 June 1998 concerning common rules for the internal market in natural gas, provided that the activity of this establishment or head office represents an effective and continuous link with the economy of the country concerned (CPC 7131).

In **BE**: In general the supply of natural gas to customers (customers being both distribution companies and consumers whose overall combined consumption of gas arising from all points of supply attains a minimum level of one million cubic metres per year) established in Belgium is subject to an individual authorisation provided by the minister, except where the supplier is a distribution company using its own distribution network. Such an authorisation may only be granted to natural or legal persons of the European Union.

In **CY**: For the cross-border supply of storage and warehousing services of fuels transported through pipelines, and the retail sales of fuel oil and bottled gas other than by mail order (CPC 613, CPC 62271, CPC 63297, CPC 7131, CPC 742).

With respect to Investment liberalisation – Market access and Cross-border trade in services – Market access:

In **HU**: The supply of pipeline transport services requires establishment. Services may be provided through a Contract of Concession granted by the state or the local authority. The supply of this service is regulated by the Hungarian Concession Law (CPC 7131).

With respect to Cross-border trade in services – Market access:

In **LT**: For pipeline transportation of fuels and services auxiliary to pipeline transport of goods other than fuel.

**Existing measures:**

**BE**: Arrêté Royal du 14 mai 2002 relatif à l'autorisation de transport de produits gazeux et autres par canalisations; and

Loi du 12 avril 1965 relative au transport de produits gazeux et autres par canalisations (article 8.2).

**BG**: Energy Act.

**CY**: The Regulation of the Electricity Market Law of 2003, Law 122(I)/2003 as amended;

The Regulating of the Gas Market Laws of 2004, Law 183(I)/2004 as amended;

The Petroleum (Pipelines) Law, Chapter 273 ;

The Petroleum Law Chapter 272 as amended; and

The Petroleum and Fuel Specifications Laws of 2003, Law 148(I)/2003 as amended.

**FI**: Maakaasumarkkinalaki (Natural Gas Market Act) (508/2000); and Maakaasumarkkinalaki (Natural Gas Market Act) (587/2017).

**FR:** Code de l'énergie.

**HU:** Act XVI of 1991 about Concessions.

**LT:** Law on Natural Gas of the Republic of Lithuania of 10 October 2000 No VIII-1973.

**PT:** Decree-Law 230/2012 and Decree-Law 231/2012, 26 October - Natural Gas; Decree-Law 215-A/2012, and Decree-Law 215-B/2012, 8 October – Electricity; and Decree-Law 31/2006, 15 February – Crude oil/Petroleum products.

**(d) Nuclear (ISIC Rev. 3.1 12, 3.1 23, 120, 1200, 233, 2330, 40, part of 4010, CPC 887))**

With respect to Investment liberalisation – Market access, National treatment, Senior management and boards of directors and Cross-border trade in services – Market access, National treatment:

In **DE:** For the production, processing or transportation of nuclear material and generation or distribution of nuclear-based energy.

With respect to Investment liberalisation – Market access, National treatment and Cross-border trade in services – Market access, National treatment:

In **AT** and **FI:** for the production, processing distribution or transportation of nuclear material and generation or distribution of nuclear-based energy.

In **BE:** For the production, processing or transportation of nuclear material and generation or distribution of nuclear-based energy.

With respect to Investment liberalisation – Market access, National treatment, Senior management and boards of directors, Performance requirements:

In **HU** and **SE:** For the processing of nuclear fuel and nuclear-based electricity generation.

With respect to Investment liberalisation – Market access, National treatment, Senior management and boards of directors:

In **BG:** For the processing of fissionable and fusionable materials or the materials from which they are derived, as well as to the trade therewith, to the maintenance and repair of equipment and systems in nuclear energy production facilities, to the transportation of those materials and the refuse and waste matter of their processing, to the use of ionising radiation, and on all other services relating to the use of nuclear energy for peaceful purposes (including engineering and consulting services and services relating to software etc.).

With respect to Investment liberalisation – Market access, National treatment:

In **FR:** These activities must respect the obligations of an Euratom Agreement.

***Existing measures:***

**AT:** Bundesverfassungsgesetz für ein atomfreies Österreich (Constitutional Act for a Non-nuclear Austria) BGBl. I Nr. 149/1999.

**BG:** Safe Use of Nuclear Energy Act.

**FI:** Ydinenergi laki (Nuclear Energy Act) (990/1987).

**HU:** Act CXVI of 1996 on Nuclear Energy; and  
Government Decree Nr. 72/2000 on Nuclear Energy.

**SE:** The Swedish Environmental Code (1998:808); and Law on Nuclear Technology Activities (1984:3).

## Reservation No. 23 - Other services not included elsewhere

<b>Sector:</b>	Other services not included elsewhere
<b>Industry classification:</b>	CPC 9703, part of CPC 612, part of CPC 621, part of CPC 625, part of 85990
<b>Type of reservation:</b>	Market access National treatment Senior management and board of directors Performance requirements Local presence
<b>Chapter:</b>	Investment Liberalisation and Cross-Border Trade in Services

### Description:

The EU reserves the right to adopt or maintain any measure with respect to the following:

#### **(a) Funeral, cremation services and undertaking services (CPC 9703)**

With respect to Investment liberalisation – Market access, National treatment:

In **FI**: Cremation services and operation/maintenance of cemeteries and graveyards can only be performed by the state, municipalities, parishes, religious communities or non-profit foundations or societies.

With respect to Investment liberalisation – Market access, National treatment, Senior management and boards of directors and Cross-border trade in services – Market access, National treatment, Local presence:

In **DE**: Only legal persons established under public law may operate a cemetery. The creation and operation of cemeteries and services related to funerals.

In **PT**: Commercial presence is required to provide funeral and undertaking services. EEA nationality is required in order to become a technical manager for entities providing funeral and undertaking services.

In **SE**: Church of Sweden or local authority monopoly on cremation and funeral services.

In **CY, SI**: Funeral, cremation and undertaking services.

#### **Existing measures:**

**FI**: Hautaustoimilaki (Act on Burial Service) (457/2003).

**PT**: Decree-Law 10/2015, of 16 January alterado p/ Lei 15/2018, 27 março.

**SE**: Begravningslag (1990:1144) (Act of Burials); Begravningsförrordningen (1990:1147) (Ordinance of Burials).

#### **(b) Other business-related services**

With respect to Cross-border trade in services – Market access:

In **FI**: Require establishment in Finland or elsewhere in the EEA in order to provide electronic identification services.

***Existing measures:***

**FI**: Laki vahvasta sähköisestä tunnistamisesta ja sähköisistä luottamuspalveluista 617/2009 (Act on Strong Electronic Identification and Electronic Trust Services 617/2009).

**(c)      *New services***

With respect to Investment liberalisation – Market access, National treatment, Senior management and boards of directors, Performance requirements and Cross-border trade in services – Market access, National treatment, Local presence:

The **EU**: For the provision of new services other than those classified in the United Nations Provisional Central Product Classification (CPC), 1991.

### **Schedule of the United Kingdom**

**Reservation No. 1 – All sectors**

**Reservation No. 2 – Professional services (all professions except health related)**

**Reservation No. 3 – Professional services (health related and retail of pharmaceuticals)**

**Reservation No. 4 – Business services (collection agency services and credit reporting services)**

**Reservation No. 5 – Business services (placement services)**

**Reservation No. 6 – Business services (investigation services)**

**Reservation No. 7 – Business services (other business services)**

**Reservation No. 8 – Education services**

**Reservation No. 9 – Financial services**

**Reservation No. 10 – Health and social services**

**Reservation No. 11 – Recreational, cultural and sporting services**

**Reservation No. 12 – Transport services and auxiliary transport services**

**Reservation No. 13 – Fishing and water**

**Reservation No. 14 – Energy related activities**

**Reservation No. 15 – Other services not included elsewhere**

## Reservation No. 1 – All sectors

**Sector:** *All sectors*

**Type of reservation:** Market access  
National treatment  
Senior management and board of directors  
Performance requirements  
Local presence  
Obligations for Legal Services

**Chapter:** Investment Liberalisation, Cross-Border Trade in Services and  
Regulatory Frameworks

### **Description:**

The UK reserves the right to adopt or maintain any measure with respect to the following:

#### **(a) *Commercial presence***

With respect to Investment Liberalisation – Market access:

Services considered as public utilities at a national or local level may be subject to public monopolies or to exclusive rights granted to private operators.

Public utilities exist in sectors such as related scientific and technical consulting services, research and development (R&D) services on social sciences and humanities, technical testing and analysis services, environmental services, health services, transport services and services auxiliary to all modes of transport. Exclusive rights on such services are often granted to private operators, for instance operators with concessions from public authorities, subject to specific service obligations. Given that public utilities often also exist at the sub-central level, detailed and exhaustive sector-specific scheduling is not practical. This reservation does not apply to telecommunications and to computer and related services.

#### **(b) *Most favoured nation treatment***

With respect to Investment Liberalisation – Most favoured nation treatment and Cross-Border Trade in Services – Most favoured nation treatment and Regulatory Framework for Legal Services – Obligations:

According differential treatment pursuant to any international investment treaties or other trade agreement in force or signed prior to entry into force of this Agreement.

According differential treatment to a country pursuant to any existing or future bilateral or multilateral agreement which:

- (i) creates an internal market in services and investment;
- (ii) grants the right of establishment; or
- (iii) requires the approximation of legislation in one or more economic sectors.

An internal market on services and establishment means an area without internal frontiers in which the free movement of services, capital and persons is ensured.

The right of establishment means an obligation to abolish in substance all barriers to establishment among the parties to the regional economic integration agreement by the entry into force of that agreement. The right of establishment shall include the right of nationals of the parties to the regional economic integration agreement to set up and operate enterprises under the same conditions provided for nationals under the law of the country where such establishment takes place.

The approximation of legislation means:

- (i) the alignment of the legislation of one or more of the parties to the regional economic integration agreement with the legislation of the other Party or parties to that agreement; or
- (ii) the incorporation of common legislation into the law of the parties to the regional economic integration agreement.

Such alignment or incorporation shall take place, and shall be deemed to have taken place, only at such time that it has been enacted in the law of the Party or parties to the regional economic integration agreement.

According differential treatment relating to the right of establishment to nationals or enterprises through existing or future bilateral agreements between the UK and any of the following countries or principalities: Andorra, Monaco, San Marino and the Vatican City State.

**(c) *Arms, ammunitions and war material***

With respect to Investment Liberalisation – Market access, National treatment, Most favoured nation treatment, Senior management and boards of directors, Performance requirements and Cross-Border Trade in Services – Market access, Local presence, National treatment, Most favoured nation treatment:

Production or distribution of, or trade in, arms, munitions and war material. War material is limited to any product which is solely intended and made for military use in connection with the conduct of war or defence activities.



## **Reservation No. 2 – Professional services (all professions except health related)**

**Sector – sub-sector:** Professional services - legal services, auditing services

**Industry classification:** Part of CPC 861, part of 87902, part of 862

**Type of reservation:** Market access  
National treatment  
Senior management and board of directors  
Local presence  
Obligations for Legal Services

**Chapter:** Investment Liberalisation, Cross-Border Trade in Services and  
Regulatory Frameworks

### **Description:**

#### **(a) *Legal services***

With respect to Investment Liberalisation – Market access, Senior management and boards of directors, National treatment, Cross-Border Trade in Services – Market access, Local presence, National treatment and Regulatory Frameworks – Legal services commitments:

The UK reserves the right to adopt or maintain any measure with respect to the supply of legal advisory and legal authorisation, documentation, and certification services provided by legal professionals entrusted with public functions, such as notaries, and with respect to services provided by bailiffs (part of CPC 861, part of 87902).

#### **(b) *Auditing services (CPC 86211, 86212 other than accounting and bookkeeping services)***

With respect to Cross-Border Trade in Services – Market access, Local presence, National treatment:

The UK reserves the right to adopt or maintain any measure with respect to the cross-border supply of auditing services.

#### ***Existing measures:***

Companies Act 2006

### Reservation No. 3 - Professional services (health related and retail of pharmaceuticals)

<b>Sector:</b>	Health related professional services and retail sales of pharmaceutical, medical and orthopaedic goods, other services provided by pharmacists
<b>Industry classification:</b>	CPC 63211, 85201, 9312, 9319, 93121
<b>Type of reservation:</b>	Market access National treatment Local presence
<b>Chapter:</b>	Investment Liberalisation and Cross-Border Trade in Services

#### Description:

The UK reserves the right to adopt or maintain any measure with respect to the following:

**(a) *Medical and dental services; services provided by midwives, nurses, physiotherapists, psychologists and paramedical personnel (CPC 63211, 85201, 9312, 9319)***

With respect to Investment Liberalisation – Market access:

Establishment for doctors under the National Health Service is subject to medical manpower planning (CPC 93121, 93122).

With respect to Cross-Border Trade in Services – Market access, Local presence, National treatment:

The supply of all health-related professional services, including the services provided by professionals such as medical doctors, dentists, midwives, nurses, physiotherapists, paramedics, and psychologists, requires residency. These services may only be provided by natural persons physically present in the territory of the UK (CPC 9312, part of 93191).

The cross-border supply of medical, dental and midwives services and services provided by nurses, physiotherapists, psychologists and paramedical personnel (part of CPC 85201, 9312, part of 93191).

For service suppliers not physically present in the territory of the UK (part of CPC 85201, 9312, part of 93191).

**(b) *Retail sales of pharmaceutical, medical and orthopaedic goods, other services provided by pharmacists (CPC 63211)***

With respect to Investment Liberalisation – Market access and Cross-Border Trade in Services – Market access, Local presence:

Mail order is only possible from the UK, thus establishment in the UK is required for the retail of pharmaceuticals and specific medical goods to the general public in the UK.

With respect to Cross-Border Trade in Services – Market access, Local presence, National treatment:

The cross-border retail sales of pharmaceuticals and of medical and orthopaedic goods, and other services supplied by pharmacists.

**Reservation No. 4 – Business services (collection agency services and credit reporting services)**

**Sector – sub-sector:** Business services - collection agency services, credit reporting services

**Industry classification:** CPC 87901, 87902

**Type of reservation:** Market access  
National treatment  
Local presence

**Chapter:** Cross-Border Trade in Services

**Description:**

The UK reserves the right to adopt or maintain any measure with respect to the supply of collection agency services and credit reporting services.

**Reservation No. 5 – Business services (placement services)**

**Sector – sub-sector:** Business Services – placement services

**Industry classification:** CPC 87202, 87204, 87205, 87206, 87209

**Type of reservation:** Market access  
National treatment  
Senior management and board of directors  
Local presence

**Chapter:** Investment Liberalisation and Cross-Border Trade in Services

**Description:**

The UK reserves the right to adopt or maintain any measure with respect to the following:

The supply of placement services of domestic help personnel, other commercial or industrial workers, nursing and other personnel (CPC 87204, 87205, 87206, 87209).

To require establishment and to prohibit the cross-border supply of placement services of office support personnel and other workers.

**Reservation No. 6 – Business services (investigation services)**

**Sector – sub-sector:** Business Services – investigation services

**Industry classification:** CPC 87301

**Type of reservation:** Market access  
National treatment  
Senior management and board of directors  
Performance requirements  
Local presence

**Chapter:** Investment Liberalisation and Cross-Border Trade in Services

**Description:**

The UK reserves the right to adopt or maintain any measure with respect to the supply of investigation services (CPC 87301).

## Reservation No. 7 – Business services (other business services)

**Sector – sub-sector:** Business services – other business services

**Industry classification:** CPC 86764, 86769, 8868, part of 8790

**Type of reservation:** Market access  
National treatment  
Most favoured nation treatment  
Local presence

**Chapter:** Investment Liberalisation and Cross-Border Trade in Services

### Description:

The UK reserves the right to adopt or maintain any measure with respect to the following:

**(a) *Maintenance and repair of vessels, rail transport equipment and aircraft and parts thereof (part of CPC 86764, CPC 86769, CPC 8868)***

With respect to Cross-Border Trade in Services – Market access, Local presence, National treatment:

To require establishment or physical presence in its territory and prohibiting the cross-border supply of maintenance and repair services of rail transport equipment from outside its territory.

To require establishment or physical presence in its territory and prohibiting the cross-border supply of maintenance and repair services of internal waterways transport vessels from outside its territory.

To require establishment or physical presence in its territory and prohibiting the cross-border supply of maintenance and repair services of maritime vessels from outside its territory.

To require establishment or physical presence in its territory and prohibiting the cross-border supply of maintenance and repair services of aircraft and parts thereof from outside its territory (part of CPC 86764, CPC 86769, CPC 8868).

Only recognised organisations authorised by the UK may carry out statutory surveys and certification of ships on behalf of the UK. Establishment may be required.

### ***Existing measures:***

Regulation (EC) 391/2009 of the European Parliament and the Council of 23 April 2009 on common rules and standards for ship inspection and survey organisations as retained in UK law by the European Union (Withdrawal) Act 2018, and as amended by the Merchant Shipping (Recognised Organisations) (Amendment) (EU Exit) Regulations 2019.

**(b) *Other business services related to aviation***

With respect to Investment Liberalisation - Most favoured nation treatment and Cross-Border Trade in Services – Most favoured nation treatment:

According differential treatment to a third country pursuant to existing or future bilateral agreements relating to the following services:

- (i) aircraft repair and maintenance services;
- (ii) rental or leasing of aircraft without crew;
- (iii) computer reservation system (CRS) services;
- (iv) the following services provided using a manned aircraft, subject to compliance with the Parties' respective laws and regulations governing the admission of aircrafts to, departure from and operation within, their territory: aerial fire-fighting, flight training, spraying, surveying, mapping, photography, and other airborne agricultural, industrial and inspection services; and
- (v) the selling and marketing of air transport services.



## **Reservation No. 8 – Education services**

<b>Sector:</b>	Education services
<b>Industry classification:</b>	CPC 92
<b>Type of reservation:</b>	Market access National treatment Senior management and board of directors Performance requirements Local presence
<b>Chapter:</b>	Investment Liberalisation and Cross-Border Trade in Services

### **Description:**

The UK reserves the right to adopt or maintain any measure with respect to the following:

All educational services which receive public funding or State support in any form, and are therefore not considered to be privately funded. Where the supply of privately funded education services by a foreign provider is permitted, participation of private operators in the education system may be subject to the granting of a concession allocated on a non-discriminatory basis.

The supply of privately funded other education services, which means other than those classified as being primary, secondary, higher and adult education services (CPC 929).

## Reservation No. 9 – Financial services

**Sector:** Financial services

**Industry classification:**

**Type of reservation:** Market access  
National treatment  
Most favoured nation treatment  
Local presence

**Chapter:** Investment Liberalisation and Cross-Border Trade in Services

### Description:

The UK reserves the right to adopt or maintain any measure with respect to the following:

**(a) *All financial services***

With respect to Investment Liberalisation – Market access:

To require a financial service supplier, other than a branch, when establishing in the UK to adopt a specific legal form, on a non-discriminatory basis.

With respect to Investment Liberalisation – Most favoured nation treatment and Cross-Border Trade in Services – Most favoured nation treatment:

According differential treatment to an investor or a financial services supplier of a third country pursuant to any bilateral or multilateral international investment treaty or other trade agreement.

**(b) *Insurance and insurance-related services***

With respect to Cross-Border Trade in Services – Market access, National treatment, Local presence:

For the supply of insurance and insurance-related services except for:

(i) direct insurance services (including co-insurance) and direct insurance intermediation for the insurance of risks relating to:

- maritime transport and commercial aviation and space launching and freight (including satellites), with such insurance to cover any or all of the following: the goods being transported, the vehicle transporting the goods, and any liability deriving therefrom; and
- goods in international transit;

(ii) Reinsurance and retrocession; and

(iii) Services auxiliary to insurance.

**(c) *Banking and other financial services***

With respect to Investment Liberalisation – Market access and Cross-Border Trade in Services – Local presence:

Only firms having their registered office in the UK can act as depositories of the assets of investment funds. The establishment of a specialised management company, having its head office and registered office in the UK, is required to perform the activities of management of common funds, including unit trusts, and where allowed under national law, investment companies.

With respect to Cross-Border Trade in Services – Market access, National treatment, local presence:

For the supply of banking and other financial services, except for:

- (i) the provision and transfer of financial information, and financial data processing and related software by suppliers of other financial services; and
- (ii) advisory and other auxiliary financial services relating to banking and other financial services as described point (L) of the definition of banking and other financial services (excluding insurance) in point (a)(ii) of Article SERVIN 5.38 [Financial services – Definitions], but not intermediation as described in point (L) of that definition.

## Reservation No. 10 – Health and social services

<b>Sector:</b>	Health and social services
<b>Industry classification:</b>	CPC 931 other than 9312, part of 93191
<b>Type of reservation:</b>	Market access National treatment Senior management and board of directors Performance requirements Local presence
<b>Chapter:</b>	Investment Liberalisation and Cross-Border Trade in Services

### Description:

The UK reserves the right to adopt or maintain any measure with respect to the following:

**(a) *Health services – hospital, ambulance, residential health services (CPC 931 other than 9312, part of 93191)***

With respect to Investment Liberalisation - Market access, National treatment, Performance requirements, Senior management and boards of directors:

For the supply of all health services which receive public funding or State support in any form, and are therefore not considered to be privately funded.

All privately funded health services other than hospital services. The participation of private operators in the privately funded health network may be subject to concession on a non-discriminatory basis. An economic needs test may apply. Main criteria: number of and impact on existing establishments, transport infrastructure, population density, geographic spread, and creation of new employment.

This reservation does not relate to the supply of all health-related professional services, including the services supplied by professionals such as medical doctors, dentists, midwives, nurses, physiotherapists, paramedics, and psychologists, which are covered by other reservations (CPC 931 other than 9312, part of 93191).

**(b) *Health and social services, including pension insurance***

With respect to Cross-Border Trade in Services – Market access, Local presence, National treatment:

Requiring establishment or physical presence in its territory of suppliers and restricting the cross-border supply of health services from outside its territory, the cross-border supply of social services from outside its territory, as well as activities or services forming part of a public retirement plan or statutory system of social security. This reservation does not relate to the supply of all health-related professional services, including the services provided by professionals such as medical doctors, dentists, midwives, nurses, physiotherapists, paramedics, and psychologists, which are covered by other reservations (CPC 931 other than 9312, part of 93191).

**(c) Social services, including pension insurance**

With respect to Investment Liberalisation – Market access, National treatment, Senior management and boards of directors, Performance requirements:

The supply of all social services which receive public funding or State support in any form, and are therefore not considered to be privately funded, and activities or services forming part of a public retirement plan or statutory system of social security. The participation of private operators in the privately funded social network may be subject to concession on a non-discriminatory basis. An economic needs test may apply. Main criteria: number of and impact on existing establishments, transport infrastructure, population density, geographic spread, and creation of new employment.

The supply of privately funded social services other than services relating to convalescent and rest houses and old people's homes.

## Reservation No. 11 – Recreational, cultural and sporting services

**Sector:** Recreational, cultural and sporting services

**Industry classification:** CPC 963, 9619, 964

**Type of reservation:** Market access  
National treatment  
Senior management and board of directors  
Performance requirements  
Local presence

**Chapter:** Investment Liberalisation and Cross-Border Trade in Services

### Description:

The UK reserves the right to adopt or maintain any measure with respect to the following:

**(a) *Libraries, archives, museums and other cultural services (CPC 963)***

The supply of library, archive, museum and other cultural services.

**(b) *Entertainment services, theatre, live bands and circus services (CPC 9619, 964 other than 96492)***

The cross-border supply of entertainment services, including theatre, live bands, circus and discotheque services.

**(c) *Gambling and betting services (CPC 96492)***

The supply of gambling activities, which involve wagering a stake with pecuniary value in games of chance, including in particular lotteries, scratch cards, gambling services offered in casinos, gambling arcades or licensed premises, betting services, bingo services and gambling services operated by and for the benefit of charities or non-profit-making organisations.

## Reservation No. 12 – Transport services and auxiliary transport services

**Sector:** Transport services

**Type of reservation:** Market access  
National treatment  
Most favoured nation treatment  
Senior management and board of directors  
Performance requirements  
Local presence

**Chapter:** Investment Liberalisation and Cross-Border Trade in Services

### Description:

The UK reserves the right to adopt or maintain any measure with respect to the following:

#### **(a) *Maritime transport – any other commercial activity undertaken from a ship***

With respect to Investment Liberalisation – Market access, National treatment, Senior management and boards of directors, Performance requirements and Cross-Border Trade in Services – Market access, Local presence, National treatment:

The nationality of the crew on a seagoing or non-seagoing vessel.

With respect to Investment Liberalisation – Market access, National treatment, Most favoured nation treatment, Senior management and boards of directors:

For the purpose of registering a vessel and operating a fleet under the flag of the UK (all commercial marine activity undertaken from a seagoing ship, including fishing, aquaculture, and services incidental to fishing; international passenger and freight transportation (CPC 721); and services auxiliary to maritime transport). This reservation does not apply to legal persons incorporated in the UK and having an effective and continuous link to its economy.

#### **(b) *Auxiliary services to maritime transport***

With respect to Investment Liberalisation – Market access, National treatment, Senior management and boards of directors and Cross-Border Trade in Services – Market access, Local presence, National treatment:

The supply of pilotage and berthing services. For greater certainty, regardless of the criteria which may apply to the registration of ships in the UK, the UK reserves the right to require that only ships registered on the national registers of the UK may provide pilotage and berthing services (CPC 7452).

Only vessels carrying the flag of the UK may provide pushing and towing services (CPC 7214).

#### **(c) *Auxiliary services to inland waterways transport***

With respect to Investment Liberalisation – Market access, National treatment, Most favoured nation treatment, Senior management and boards of directors, Performance requirements and

Cross-Border Trade in Services – Market access, Local presence, National treatment, Most favoured nation treatment:

Services auxiliary to inland waterways transportation.

**(d) Rail transport and auxiliary services to rail transport**

With respect to Investment Liberalisation – Market access, National treatment and Cross-Border Trade in Services – Market access, Local presence, National treatment:

Railway passenger transportation (CPC 7111).

With respect to Investment Liberalisation – Market access and Cross-Border Trade in Services – Market access, Local presence:

Railway freight transportation (CPC 7112).

**(e) Road transport (passenger transportation, freight transportation, international truck transport services) and services auxiliary to road transport**

With respect to Cross-Border Trade in Services – Market access, National treatment, Local presence:

For road transport services covered by Chapter 3 and 4 of Title XII (Transport) of Part 2 (Economy and Trade) and Annex ROAD-1 to Chapter 3.

With respect to Investment Liberalisation – Market access, National treatment, Senior management and boards of directors and Cross-Border Trade in Services – Market access, Local presence, National treatment:

For road transport services not covered by Chapter 3 and 4 of Title XII (Transport) of Part 2 (Economy and Trade) and Annex ROAD-1 to Chapter 3:

- (i) to require establishment and to limit the cross-border supply of road transport services (CPC 712);
- (ii) an economic needs test may apply to taxi services in the UK setting a limit on the number of service suppliers. Main criteria: Local demand as provided in applicable laws (CPC 71221).

**Existing measures:**

Regulation (EC) No 1071/2009 of the European Parliament and of the Council of 21 October 2009 establishing common rules concerning the conditions to be complied with to pursue the occupation of road transport operator and repealing Council Directive 96/26/EC as retained in UK law by the European Union (Withdrawal) Act 2018 and as amended by the Licensing of Operators and International Road Haulage (Amendment etc.) (EU Exit) Regulations 2019;

Regulation (EC) No 1072/2009 of the European Parliament and of the Council of 21 October 2009 on common rules for access to the international road haulage market as retained in UK law by the European Union (Withdrawal) Act 2018 and as amended by the Licensing of Operators and International Road Haulage (Amendment etc.) (EU Exit) Regulations 2019; and

Regulation (EC) No 1073/2009 of the European Parliament and of the Council of 21 October 2009 on common rules for access to the international market for coach and bus services, and amending Regulation (EC) No 561/2006 as retained in UK law by the European Union (Withdrawal) Act 2018



and as amended by the Common Rules for Access to the International Market for Coach and Bus Services (Amendment etc.) (EU Exit) Regulations 2019.

**(f) *Space transport and rental of space craft***

With respect to Investment Liberalisation – Market access, National treatment, Performance requirements, Senior management and boards of directors and Cross-Border Trade in Services – Market access, Local presence, National treatment:

Transportation services via space and the rental of space craft (CPC 733, part of 734).

**(g) *Most favoured nation exemptions***

With respect to Investment Liberalisation – Most favoured nation treatment, and Cross-Border Trade in Services – Most favoured nation treatment:

(i) Road and rail transport

To accord differential treatment to a country pursuant to existing or future bilateral agreements relating to international road haulage (including combined transport – road or rail) and passenger transport, concluded between the UK and a third country (CPC 7111, 7112, 7121, 7122, 7123). That treatment may:

- reserve or limit the supply of the relevant transport services between the contracting parties or across the territory of the contracting parties to vehicles registered in each contracting party; or
- provide for tax exemptions for such vehicles.

(ii) Air transport - Services auxiliary to air transport

According differential treatment to a third country pursuant to existing or future bilateral agreements relating to ground-handling services.

## Reservation No. 13 – Fishing and water

<b>Sector:</b>	Fishing, aquaculture, services incidental to fishing; collection, purification and distribution of water
<b>Industry classification:</b>	ISIC Rev. 3.1 0501, 0502, CPC 882, ISIC Rev. 3.1 41
<b>Type of reservation:</b>	Market access National treatment Most favoured nation treatment Senior management and board of directors Performance requirements Local presence
<b>Chapter:</b>	Investment Liberalisation and Cross-Border Trade in Services

### Description:

The UK reserves the right to adopt or maintain any measure with respect to the following:

#### **(a) *Fishing, aquaculture and services incidental to fishing (ISIC Rev. 3.1 0501, 0502, CPC 882)***

With respect to Investment Liberalisation – Market access, National treatment, Senior management and boards of directors, Performance requirements, Most favoured nation treatment and Cross-Border Trade in Services – Market access, National treatment, Local presence, Most favoured nation treatment:

1. In particular within the framework of United Kingdom fisheries policy, and of fishing agreements with a third country, access to and use of biological resources and fishing grounds situated in the maritime waters coming under the sovereignty or jurisdiction of the United Kingdom, or entitlements for fishing under a United Kingdom fishing licence, including:

(a) regulating the landing of catches by vessels flying the flag of a Member State or a third country with respect to the quotas allocated to them or, only with respect to vessels flying the flag of the United Kingdom, requiring that a proportion of the total catch is landed in United Kingdom ports;

(b) determining a minimum size for a company in order to preserve both artisanal and coastal fishing vessels;

(c) according differential treatment pursuant to existing or future international agreements relating to fisheries; and

(d) requiring the crew of a vessel flying the flag of the United Kingdom to be United Kingdom nationals.

2. A fishing vessel's entitlement to fly the flag of the United Kingdom only if:

- (a) it is wholly owned by:
    - (i) companies incorporated in the United Kingdom; or
    - (ii) United Kingdom nationals;
  - (b) its day-to-day operations are directed and controlled from within the United Kingdom; and
  - (c) any charterer, manager or operator of the vessel is a company incorporated in the United Kingdom or a United Kingdom national.
3. A commercial fishing licence granting the right to fish in the territorial waters of the United Kingdom may only be granted to vessels flying the flag of the United Kingdom.
4. The establishment of marine or inland aquaculture facilities.
5. Point 1(a), (b), (c) (other than with respect to most-favoured nation treatment) and (d), point 2(a)(i), (b) and (c) and point 3 only apply to measures which are applicable to vessels or to enterprises irrespective of the nationality of their beneficial owners.

**(b) *Collection, purification and distribution of water***

With respect to Investment Liberalisation – Market access, National treatment and Cross-Border Trade in Services – Market access, Local presence, National treatment:

For activities, including services relating to the collection, purification and distribution of water to household, industrial, commercial or other users, including the supply of drinking water, and water management.

## **Reservation No. 14 – Energy related activities**

<b>Sector:</b>	Production of energy and related services
<b>Industry classification:</b>	ISIC Rev. 3.1 401, 402, CPC 7131, CPC 887 (other than advisory and consulting services).
<b>Type of reservation:</b>	Market access National treatment Senior management and board of directors Performance requirements Local presence
<b>Chapter:</b>	Investment Liberalisation and Cross-Border Trade in Services

### **Description:**

The UK reserves the right to adopt or maintain any measure, where the UK permits foreign ownership of a gas or electricity transmission system, or an oil and gas pipeline transport system, with respect to enterprises of the Union controlled by natural persons or enterprises of a third country which accounts for more than 5 per cent of the UK's oil, natural gas or electricity imports, in order to guarantee the security of the energy supply of the UK. This reservation does not apply to advisory and consultancy services provided as services incidental to energy distribution.

**Reservation No. 15 – Other services not included elsewhere**

**Sector:** Other services not included elsewhere

**Type of reservation:** Market access  
National treatment  
Senior management and board of directors  
Performance requirements  
Local presence

**Chapter:** Investment Liberalisation and Cross-Border Trade in Services

**Description:**

The UK reserves the right to adopt or maintain any measure with respect to the provision of new services other than those classified in the United Nations Provisional Central Product Classification (CPC), 1991.

*ANNEX SERVIN-3: BUSINESS VISITORS FOR ESTABLISHMENT PURPOSES, INTRA-CORPORATE  
TRANSFEREES AND SHORT-TERM BUSINESS VISITORS*

1. A measure listed in this Annex may be maintained, continued, promptly renewed, or amended, provided that the amendment does not decrease the conformity of the measure with Articles SERVIN.4.2 [Intra-corporate Transferees and Business Visitors for Establishment Purposes] and SERVIN.4.3 [Short-term business visitors], as it existed immediately before the amendment.

2. Articles SERVIN.4.2 [Intra-corporate Transferees and Business Visitors for Establishment Purposes] and SERVIN.4.3 [Short-term business visitors] do not apply to any existing non-conforming measure listed in this Annex, to the extent of the non-conformity.

3. The schedules in paragraphs 6, 7 and 8 apply only to the territories of the United Kingdom and the European Union in accordance with Article FINPROV.1 [Territorial Scope] and Article OTH.9.2 [Geographical Scope] and are only relevant in the context of trade relations between the European Union and its Member States with the United Kingdom. They do not affect the rights and obligations of the Member States under Union law.

4. For greater certainty, for the European Union, the obligation to grant national treatment does not entail the requirement to extend to natural or legal persons of the United Kingdom the treatment granted in a Member State, in application of the Treaty on the Functioning of the European Union, or of any measure adopted pursuant to that Treaty, including their implementation in the Member States, to:

- (i) natural persons or residents of another Member State; or
- (ii) legal persons constituted or organised under the law of another Member State or of the European Union and having their registered office, central administration or principal place of business in the European Union.

5. The following abbreviations are used in the paragraphs below:

AT	Austria
BE	Belgium
BG	Bulgaria
CY	Cyprus
CZ	Czech Republic
DE	Germany
DK	Denmark
EE	Estonia
EL	Greece
ES	Spain
EU	European Union, including all its Member States

FI	Finland
FR	France
HR	Croatia
HU	Hungary
IE	Ireland
IT	Italy
LT	Lithuania
LU	Luxembourg
LV	Latvia
MT	Malta
NL	The Netherlands
PL	Poland
PT	Portugal
RO	Romania
SE	Sweden
SI	Slovenia
SK	Slovak Republic

6. The European Union's non-conforming measures are:

Business visitors for establishment purposes

<b>All sectors</b>	<p><b>AT, CZ:</b> Business visitor for establishment purposes needs to work for an enterprise other than a non-profit organisation, otherwise: Unbound.</p> <p><b>SK:</b> Business visitor for establishment purposes needs to work for an enterprise other than a non-profit organisation, otherwise: Unbound. Work permit required, including economic needs test.</p> <p><b>CY:</b> Permissible length of stay: up to 90 days in any twelve month period. Business visitor for establishment purposes needs to work for an enterprise other than a non-profit organisation, otherwise: Unbound.</p>
--------------------	--

Intra-corporate transferees

<b>All sectors</b>	<p><b>EU:</b> Until 31 December 2022 any charge, fee or tax imposed by a Party (other than fees associated with the processing of a visa, work permit, or residency permit application or renewal) on the grounds of being allowed to perform an activity or to hire a person who can perform such activity in the territory of a Party, unless it is a requirement consistent with paragraph 3 of SERVIN 4.1 [Scope and definitions], or a health fee under national legislation in connection with an application for a permit to enter, stay, work, or reside in the territory of a Party.</p> <p><b>AT, CZ, SK:</b> Intra-corporate transferees need to be employed by an enterprise other than a non-profit organisation, otherwise: Unbound.</p> <p><b>FI:</b> Senior personnel needs to be employed by an enterprise other than a non-profit organisation.</p> <p><b>HU:</b> Natural persons who have been a partner in an enterprise do not qualify to be transferred as intra-corporate transferees.</p>
--------------------	---

#### Short-term business visitors

<b>All activities referred to in paragraph 8:</b>	<p><b>CY, DK, HR:</b> Work permit, including economic needs test, required in case the short-term business visitor supplies a service.</p> <p><b>LV:</b> Work permit required for operations/activities to be performed on the basis of a contract.</p> <p><b>MT:</b> Work permit required. No economic needs tests performed.</p> <p><b>SI:</b> A single residency and work permit is required for the supply of services exceeding 14 days at a time and for certain activities (research and design; training seminars; purchasing; commercial transactions; translation and interpretation). An economic needs test is not required.</p> <p><b>SK:</b> In case of supplying a service in the territory of Slovakia, a work permit, including economic needs test, is required beyond seven days in a month or 30 days in calendar year.</p>
<b>Research and design</b>	<p><b>AT:</b> Work permit, including economic needs test, required, except for research activities of scientific and statistical researchers.</p>
<b>Marketing research</b>	<p><b>AT:</b> Work permit required, including economic needs test. Economic needs test is waived for research and analysis activities for up to seven days in a month or 30 days in a calendar year. University degree required.</p> <p><b>CY:</b> Work permit required, including economic needs test.</p>
<b>Trade fairs and exhibitions</b>	<p><b>AT, CY:</b> Work permit, including economic needs test, required for activities beyond seven days in a month or 30 days in a calendar year.</p>
<b>After-sales or after-lease service</b>	<p><b>AT:</b> Work permit required, including economic needs test. Economic needs test is waived for natural persons training workers to supply services and possessing specialised knowledge.</p> <p><b>CY, CZ :</b> Work permit is required beyond seven days in a month or 30 days in calendar year.</p> <p><b>ES:</b> Installers, repair and maintainers should be employed as such by the legal person supplying the good or service or by an enterprise which is a member of the same group as the originating legal person for at least</p>



	<p>three months immediately preceding the date of submission of an application for entry and they should possess at least 3 years of relevant professional experience, where applicable, obtained after the age of majority.</p> <p><b>FI:</b> Depending on the activity, a residence permit may be required.</p> <p><b>SE:</b> Work permit required, except for (i) natural persons who participate in training, testing, preparation or completion of deliveries, or similar activities within the framework of a business transaction, or (ii) fitters or technical instructors in connection with urgent installation or repair of machinery for up to two months, in the context of an emergency. No economic needs test required.</p>
<b>Commercial transactions</b>	<p><b>AT, CY:</b> Work permit, including economic needs test, required for activities beyond seven days in a month or 30 days in a calendar year.</p> <p><b>FI:</b> The natural person needs to be supplying services as an employee of a legal person of the other Party.</p>
<b>Tourism personnel</b>	<p><b>CY, ES, PL:</b> Unbound.</p> <p><b>FI:</b> The natural person needs to be supplying services as an employee of a legal person of the other Party.</p> <p><b>SE:</b> Work permit required, except for drivers and staff of tourist buses. No economic needs test required.</p>
<b>Translation and interpretation</b>	<p><b>AT:</b> Work permit required, including economic needs test.</p> <p><b>CY, PL:</b> Unbound.</p>

7. The United Kingdom's non-conforming measures are:

Business visitors for establishment purposes

<b>All sectors</b>	Business visitor for establishment purposes needs to work for an enterprise other than a non-profit organisation, otherwise: Unbound.
--------------------	---

Intra-corporate transferees

<b>All sectors</b>	<p>Intra-corporate transferees need to be employed by an enterprise other than a non-profit organisation, otherwise: Unbound.</p> <p>Until 31 December 2022 any charge, fee or tax imposed by a Party (other than fees associated with the processing of a visa, work permit, or residency permit application or renewal) on the grounds of being allowed to perform an activity or to hire a person who can perform such activity in the territory of a Party, unless it is a requirement consistent with paragraph 3 of SERVIN 4.1 [Scope and definitions], or a health fee under national legislation in connection with an application for a permit to enter, stay, work, or reside in the territory of a Party.</p>
--------------------	--

Short-term business visitors

All activities referred to in paragraph 8:	None
--	------

8. The activities Short-term business visitors are permitted to engage in are:
- a) meetings and consultations: natural persons attending meetings or conferences, or engaged in consultations with business associates;
  - b) research and design: technical, scientific and statistical researchers conducting independent research or research for a legal person of the Party of which the Short-term business visitor is a natural person;
  - c) marketing research: market researchers and analysts conducting research or analysis for a legal person of the Party of which the Short-term business visitor is a natural person;
  - d) training seminars: personnel of an enterprise who enter the territory being visited by the Short-term business visitor to receive training in techniques and work practices which are utilised by companies or organisations in the territory being visited by the Short-term business visitor, provided that the training received is confined to observation, familiarisation and classroom instruction only;
  - e) trade fairs and exhibitions: personnel attending a trade fair for the purpose of promoting their company or its products or services;
  - f) sales: representatives of a supplier of services or goods taking orders or negotiating the sale of services or goods or entering into agreements to sell services or goods for that supplier, but not delivering goods or supplying services themselves. Short-term business visitors shall not engage in making direct sales to the general public;
  - g) purchasing: buyers purchasing goods or services for an enterprise, or management and supervisory personnel, engaging in a commercial transaction carried out in the territory of the Party of which the Short-term business visitor is a natural person;
  - h) after-sales or after-lease service: installers, repair and maintenance personnel and supervisors, possessing specialised knowledge essential to a seller's contractual obligation, supplying services or training workers to supply services pursuant to a warranty or other service contract incidental to the sale or lease of commercial or industrial equipment or machinery, including computer software, purchased or leased from a legal person of the Party of which the Short-term business visitor is a natural person throughout the duration of the warranty or service contract;
  - i) commercial transactions: management and supervisory personnel and financial services personnel (including insurers, bankers and investment brokers) engaging in a commercial transaction for a legal person of the Party of which the Short-term business visitor is a natural person;
  - j) tourism personnel: tour and travel agents, tour guides or tour operators attending or participating in conventions or accompanying a tour that has begun in the territory of the Party of which the Short-term business visitor is a natural person; and

k) translation and interpretation: translators or interpreters supplying services as employees of a legal person of the Party of which the Short-term business visitor is a natural person.

#### *ANNEX SERVIN-4: CONTRACTUAL SERVICE SUPPLIERS AND INDEPENDENT PROFESSIONALS*

1. Each Party shall allow the supply of services in its territory by contractual service suppliers or independent professionals of the other Party through the presence of natural persons, in accordance with Article SERVIN.4.4 [Contractual Service Suppliers and Independent Professionals], for the sectors listed in this Annex and subject to the relevant limitations.
2. The list below is composed of the following elements:
  - (a) the first column indicating the sector or sub-sector for which the category of contractual service suppliers and independent professionals is liberalised; and
  - (b) the second column describing the applicable limitations.
3. In addition to the list of reservations in this Annex, each Party may adopt or maintain a measure relating to qualification requirements, qualification procedures, technical standards, licensing requirements or licensing procedures that does not constitute a limitation within the meaning of Article SERVIN.4.4 [Contractual Service Suppliers and Independent Professionals]. These measures, which include requirements to obtain a licence, obtain recognition of qualifications in regulated sectors or to pass specific examinations, such as language examinations, even if not listed in this Annex, apply in any case to contractual service suppliers or independent professionals of the Parties.
4. The Parties do not undertake any commitment for contractual service suppliers and independent professionals in economic activities which are not listed.
5. In identifying individual sectors and sub-sectors: CPC means the Central Products Classification as set out in Statistical Office of the United Nations, Statistical Papers, Series M, N° 77, CPC prov., 1991.
6. In the sectors where economic needs tests are applied, their main criteria will be the assessment of:
  - (a) for the United Kingdom, the relevant market situation in the United Kingdom; and
  - (b) for the Union, the relevant market situation in the Member State of the European Union or the region where the service is to be provided, including with respect to the number of, and the impact on, services suppliers who are already supplying a service when the assessment is made.
7. The schedules in paragraphs 10 to 13 apply only to the territories of the United Kingdom and the European Union in accordance with Article FINPROV.1 [Territorial Scope] and Article OTH.9.2 [Geographical Scope] and are only relevant in the context of trade relations between the European Union and its Member States with the United Kingdom. They do not affect the rights and obligations of the Member States under Union law.
8. For greater certainty, for the European Union, the obligation to grant national treatment does not entail the requirement to extend to natural or legal persons of the United Kingdom the treatment granted in a Member State, in application of the Treaty on the Functioning of the European Union, or of any measure adopted pursuant to that Treaty, including their implementation in the Member States, to:
  - (i) natural persons or residents of another Member State; or

(ii) legal persons constituted or organised under the law of another Member State or of the European Union and having their registered office, central administration or principal place of business in the European Union.

9. The following abbreviations are used in the lists below:

AT	Austria
BE	Belgium
BG	Bulgaria
CY	Cyprus
CZ	Czech Republic
DE	Germany
DK	Denmark
EE	Estonia
EL	Greece
ES	Spain
EU	European Union, including all its Member States
FI	Finland
FR	France
HR	Croatia
HU	Hungary
IE	Ireland
IT	Italy
LT	Lithuania
LU	Luxembourg
LV	Latvia
MT	Malta
NL	The Netherlands
PL	Poland
PT	Portugal

RO	Romania
SE	Sweden
SI	Slovenia
SK	Slovak Republic
CSS	Contractual Service Suppliers
IP	Independent Professionals

### **Contractual Service Suppliers**

10. Subject to the list of reservations in paragraphs 12 and 13, the Parties takes commitments in accordance with Article SERVIN.4.4 [Contractual Service Suppliers and Independent Professionals] with respect to the mode 4 category of Contractual Service Suppliers in the following sectors or sub-sectors:

- (a) Legal advisory services in respect of public international law and home jurisdiction law;
- (b) Accounting and bookkeeping services;
- (c) Taxation advisory services;
- (d) Architectural services and urban planning and landscape architectural services;
- (e) Engineering services and integrated engineering services;
- (f) Medical and dental services;
- (g) Veterinary services;
- (h) Midwives services;
- (i) Services provided by nurses, physiotherapists and paramedical personnel;
- (j) Computer and related services;
- (k) Research and development services;
- (l) Advertising services;
- (m) Market research and opinion polling;
- (n) Management consulting services;
- (o) Services related to management consulting;
- (p) Technical testing and analysis services;

- (q) Related scientific and technical consulting services;
- (r) Mining;
- (s) Maintenance and repair of vessels;
- (t) Maintenance and repair of rail transport equipment;
- (u) Maintenance and repair of motor vehicles, motorcycles, snowmobiles and road transport equipment;
- (v) Maintenance and repair of aircrafts and parts thereof;
- (w) Maintenance and repair of metal products, of (non office) machinery, of (non transport and non office) equipment and of personal and household goods;
- (x) Translation and interpretation services;
- (y) Telecommunication services;
- (z) Postal and courier services;
- (aa) Construction and related engineering services;
- (bb) Site investigation work;
- (cc) Higher education services;
- (dd) Services relating to agriculture, hunting and forestry;
- (ee) Environmental services;
- (ff) Insurance and insurance related services advisory and consulting services;
- (gg) Other financial services advisory and consulting services;
- (hh) Transport advisory and consulting services;
- (ii) Travel agencies and tour operators' services;
- (jj) Tourist guides services;
- (kk) Manufacturing advisory and consulting services.

## Independent Professionals

11. Subject to the list of reservations in paragraphs 12 and 13, the Parties takes commitments in accordance with Article SERVIN.4.4 [Contractual Service Suppliers and Independent Professionals] with respect to the mode 4 category of Independent Professionals in the following sectors or sub-sectors:

- (a) Legal advisory services in respect of public international law and home jurisdiction law;
- (b) Architectural services and urban planning and landscape architectural services;
- (c) Engineering services and integrated engineering services;
- (d) Computer and related services;
- (e) Research and development services;
- (f) Market research and opinion polling;
- (g) Management consulting services;
- (h) Services related to management consulting;
- (i) Mining;
- (j) Translation and interpretation services;
- (k) Telecommunication services;
- (l) Postal and courier services;
- (m) Higher education services;
- (n) Insurance related services advisory and consulting services;
- (o) Other financial services advisory and consulting services;
- (p) Transport advisory and consulting services;
- (q) Manufacturing advisory and consulting services.

12. The European Union's reservations are:



Sector or sub-sector	Description of reservations
<b>All sectors</b>	<p><u>CSS and IP:</u></p> <p>In <b>AT</b>: Maximum stay shall be for a cumulative period of not more than six months in any 12 month period or for the duration of the contract, whichever is less.</p> <p>In <b>CZ</b>: Maximum stay shall be for a period of not more than 12 consecutive months or for the duration of the contract, whichever is less.</p>
<b>Legal advisory services in respect of public international law and home jurisdiction law</b> (part of CPC 861)	<p><u>CSS:</u></p> <p>In <b>AT, BE, CY, DE, EE, EL, ES, FR, HR, IE, IT, LU, NL, PL, PT, SE</b>: None.</p> <p>In <b>BG, CZ, DK, FI, HU, LT, LV, MT, RO, SI, SK</b>: Economic needs test.</p> <p><u>IP:</u></p> <p>In <b>AT, CY, DE, EE, FR, HR, IE, LU, LV, NL, PL, PT, SE</b>: None.</p> <p>In <b>BE, BG, CZ, DK, EL, ES, FI, HU, IT, LT, MT, RO, SI, SK</b>: Economic needs tests.</p>
<b>Accounting and bookkeeping services</b> (CPC 86212 other than "auditing services", 86213, 86219 and 86220)	<p><u>CSS:</u></p> <p>In <b>AT, BE, DE, EE, ES, HR, IE, IT, LU, NL, PL, PT, SI, SE</b>: None.</p> <p>In <b>BG, CZ, CY, DK, EL, FI, FR, HU, LT, LV, MT, RO, SK</b>: Economic needs test.</p> <p><u>IP:</u></p> <p><b>EU</b>: Unbound.</p>
<b>Taxation advisory services</b> (CPC 863) <sup>122</sup>	<p><u>CSS:</u></p> <p>In <b>AT, BE, DE, EE, ES, FR, HR, IE, IT, LU, NL, PL, SI, SE</b>: None.</p> <p>In <b>BG, CZ, CY, DK, EL, FI, HU, LT, LV, MT, RO, SK</b>: Economic needs test.</p> <p>In <b>PT</b>: Unbound.</p> <p><u>IP:</u></p> <p><b>EU</b>: Unbound.</p>

---

<sup>122</sup> Does not include legal advisory and legal representational services on tax matters, which are under legal advisory services in respect of public international law and home jurisdiction law.

Sector or sub-sector	Description of reservations
<p><b>Architectural services</b> and <b>Urban planning and landscape architectural services</b> (CPC 8671 and 8674)</p>	<p><u>CSS:</u> In <b>BE, CY, EE, ES, EL, FR, HR, IE, IT, LU, MT, NL, PL, PT, SI, SE</b>: None. In <b>FI</b>: None, except: The natural person must demonstrate that he or she possesses special knowledge relevant to the service being supplied. In <b>BG, CZ, DE, HU, LT, LV, RO, SK</b>: Economic needs test. In <b>DK</b>: Economic needs test, except for CSS stays of up to three months. In <b>AT</b>: Planning services only, where: Economic needs test.</p> <p><u>IP:</u> In <b>CY, DE, EE, EL, FR, HR, IE, LU, LV, MT, NL, PL, PT, SI, SE</b>: None. In <b>FI</b>: None, except: The natural person must demonstrate that he or she possesses special knowledge relevant to the service being supplied. In <b>BE, BG, CZ, DK, ES, HU, IT, LT, RO, SK</b>: Economic needs test. In <b>AT</b>: Planning services only, where: Economic needs test.</p>
<p><b>Engineering services</b> and <b>Integrated engineering services</b> (CPC 8672 and 8673)</p>	<p><u>CSS:</u> In <b>BE, CY, EE, ES, EL, FR, HR, IE, IT, LU, MT, NL, PL, PT, SI, SE</b>: None. In <b>FI</b>: None, except: The natural person must demonstrate that he or she possesses special knowledge relevant to the service being supplied. In <b>BG, CZ, DE, HU, LT, LV, RO, SK</b>: Economic needs test. In <b>DK</b>: Economic needs test, except for CSS stays of up to three months. In <b>AT</b>: Planning services only, where: Economic needs test.</p> <p><u>IP:</u> In <b>CY, DE, EE, EL, FR, HR, IE, LU, LV, MT, NL, PL, PT, SI, SE</b>: None. In <b>FI</b>: None, except: The natural person must demonstrate that he or she possesses special knowledge relevant to the service being supplied. In <b>BE, BG, CZ, DK, ES, HU, IT, LT, RO, SK</b>: Economic needs test. In <b>AT</b>: Planning services only, where: Economic needs test.</p>
<p><b>Medical (including psychologists) and dental services</b> (CPC 9312 and part of 85201)</p>	<p><u>CSS:</u> In <b>SE</b>: None. In <b>CY, CZ, DE, DK, EE, ES, IE, IT, LU, MT, NL, PL, PT, RO, SI</b>: Economic needs test. In <b>FR</b>: Economic needs test, except for psychologists, where: Unbound. In <b>AT</b>: Unbound, except for psychologists and dental services, where: Economic needs test. In <b>BE, BG, EL, FI, HR, HU, LT, LV, SK</b>: Unbound.</p> <p><u>IP:</u> <b>EU</b>: Unbound.</p>

Sector or sub-sector	Description of reservations
<b>Veterinary services</b> (CPC 932)	<p><u>CSS:</u> In SE: None. In <b>CY, CZ, DE, DK, EE, EL, ES, FI, FR, IE, IT, LT, LU, MT, NL, PL, PT, RO, SI</b>: Economic needs test. In <b>AT, BE, BG, HR, HU, LV, SK</b>: Unbound.</p> <p><u>IP:</u> <b>EU</b>: Unbound.</p>
<b>Midwives services</b> (part of CPC 93191)	<p><u>CSS:</u> In <b>IE, SE</b>: None. In <b>AT, CY, CZ, DE, DK, EE, EL, ES, FR, IT, LT, LV, LU, MT, NL, PL, PT, RO, SI</b>: Economic needs test. In <b>BE, BG, FI, HR, HU, SK</b>: Unbound.</p> <p><u>IP:</u> <b>EU</b>: Unbound.</p>
<b>Services provided by nurses, physiotherapists and paramedical personnel</b> (part of CPC 93191)	<p><u>CSS:</u> In <b>IE, SE</b>: None. In <b>AT, CY, CZ, DE, DK, EE, EL, ES, FR, IT, LT, LV, LU, MT, NL, PL, PT, RO, SI</b>: Economic needs test. In <b>BE, BG, FI, HR, HU, SK</b>: Unbound.</p> <p><u>IP:</u> <b>EU</b>: Unbound.</p>
<b>Computer and related services</b> (CPC 84)	<p><u>CSS:</u> In <b>BE, DE, EE, EL, ES, FR, HR, IE, IT, LU, LV, MT, NL, PL, PT, SI, SE</b>: None. In <b>FI</b>: None, except: The natural person must demonstrate that he or she possesses special knowledge relevant to the service being supplied. In <b>AT, BG, CZ, CY, HU, LT, RO, SK</b>: Economic needs test. In <b>DK</b>: Economic needs test except for CSS stays of up to three months.</p> <p><u>IP:</u> In <b>DE, EE, EL, FR, IE, LU, LV, MT, NL, PL, PT, SI, SE</b>: None. In <b>FI</b>: None, except: The natural person must demonstrate that he or she possesses special knowledge relevant to the service being supplied. In <b>AT, BE, BG, CZ, CY, DK, ES, HU, IT, LT, RO, SK</b>: Economic needs test. In <b>HR</b>: Unbound.</p>

Sector or sub-sector	Description of reservations
<b>Research and development Services</b> (CPC 851, 852 excluding psychologists services <sup>123</sup> , and 853)	<p><u>CSS</u>:</p> <p><b>EU except in NL, SE:</b> A hosting agreement with an approved research organisation is required<sup>124</sup>.</p> <p><b>EU except in CZ, DK, SK:</b> None</p> <p>In <b>CZ, DK, SK:</b> Economic needs test.</p> <p><u>IP</u>:</p> <p><b>EU except in NL, SE:</b> A hosting agreement with an approved research organisation is required<sup>125</sup>.</p> <p><b>EU except in BE, CZ, DK, IT, SK:</b> None</p> <p>In <b>BE, CZ, DK, IT, SK:</b> Economic needs test.</p>
<b>Advertising services</b> (CPC 871)	<p><u>CSS</u>:</p> <p>In <b>BE, DE, EE, ES, FR, HR, IE, IT, LU, NL, PL, PT, SI, SE:</b> None.</p> <p>In <b>AT, BG, CZ, CY, DK, EL, FI, HU, LT, LV, MT, RO, SK:</b> Economic needs test.</p> <p><u>IP</u>:</p> <p><b>EU:</b> Unbound, except <b>NL.</b> In <b>NL:</b> None.</p>
<b>Market research and opinion polling services</b> (CPC 864)	<p><u>CSS</u>:</p> <p>In <b>BE, DE, EE, ES, FR, IE, IT, LU, NL, PL, SE:</b> None.</p> <p>In <b>AT, BG, CZ, CY, DK, EL, FI, HR, LV, MT, RO, SI, SK:</b> Economic needs test.</p> <p>In <b>PT:</b> None, except for public opinion polling services (CPC 86402), where: Unbound.</p> <p>In <b>HU, LT:</b> Economic needs test, except for public opinion polling services (CPC 86402), where: Unbound.</p> <p><u>IP</u>:</p> <p>In <b>DE, EE, FR, IE, LU, NL, PL, SE:</b> None.</p> <p>In <b>AT, BE, BG, CZ, CY, DK, EL, ES, FI, HR, IT, LV, MT, RO, SI, SK:</b> Economic needs test.</p> <p>In <b>PT:</b> None, except for public opinion polling services (CPC 86402), where: Unbound.</p> <p>In <b>HU, LT:</b> Economic needs test, except for public opinion polling services (CPC 86402), where: Unbound.</p>

<sup>123</sup> Part of CPC 85201, which is under medical and dental services.

<sup>124</sup> For all Member States except DK, the approval of the research organisation and the hosting agreement must meet the conditions set pursuant to EU Directive 2005/71/EC of 12 October 2005.

<sup>125</sup> For all Member States except DK, the approval of the research organisation and the hosting agreement must meet the conditions set pursuant to EU Directive 2005/71/EC of 12 October 2005.

Sector or sub-sector	Description of reservations
<b>Management consulting services</b> (CPC 865)	<p><u>CSS:</u> In <b>BE, DE, EE, EL, ES, FI, FR, HR, IE, IT, LV, LU, MT, NL, PL, PT, SI, SE:</b> None. In <b>AT, BG, CZ, CY, HU, LT, RO, SK:</b> Economic needs test. In <b>DK:</b> Economic needs test, except for CSS stays of up to three months.</p> <p><u>IP:</u> In <b>CY, DE, EE, EL, FI, FR, IE, LV, LU, MT, NL, PL, PT, SI, SE:</b> None. In <b>AT, BE, BG, CZ, DK, ES, HR, HU, IT, LT, RO, SK:</b> Economic needs test.</p>
<b>Services related to management consulting</b> (CPC 866)	<p><u>CSS:</u> In <b>BE, DE, EE, EL, ES, FI, FR, HR, IE, IT, LV, LU, MT, NL, PL, PT, SI, SE:</b> None. In <b>AT, BG, CZ, CY, LT, RO, SK:</b> Economic needs test. In <b>DK:</b> Economic needs test, except for CSS stays of up to three months. In <b>HU:</b> Economic needs test, except for arbitration and conciliation services (CPC 86602), where: Unbound.</p> <p><u>IP:</u> In <b>CY, DE, EE, EL, FI, FR, IE, LV, LU, MT, NL, PL, PT, SI, SE:</b> None. In <b>AT, BE, BG, CZ, DK, ES, HR, IT, LT, RO, SK:</b> Economic needs test In <b>HU:</b> Economic needs test, except for arbitration and conciliation services (CPC 86602), where: Unbound.</p>
<b>Technical testing and analysis services</b> (CPC 8676)	<p><u>CSS:</u> In <b>BE, DE, EE, EL, ES, FR, HR, IE, IT, LU, NL, PL, SI, SE:</b> None. In <b>AT, BG, CZ, CY, FI, HU, LT, LV, MT, PT, RO, SK:</b> Economic needs test. In <b>DK:</b> Economic needs test, except for CSS stays of up to three months.</p> <p><u>IP:</u> <b>EU:</b> Unbound, except <b>NL.</b> In <b>NL:</b> None.</p>
<b>Related scientific and technical consulting services</b> (CPC 8675)	<p><u>CSS:</u> In <b>BE, EE, EL, ES, HR, IE, IT, LU, NL, PL, SI, SE:</b> None. In <b>AT, CZ, CY, DE, DK, FI, HU, LT, LV, MT, PT, RO, SK:</b> Economic needs test. In <b>DE:</b> None, except for publicly appointed surveyors, where: Unbound. In <b>FR:</b> None, except for "surveying" operations relating to the establishment of property rights and to land law, where: Unbound. In <b>BG:</b> Unbound.</p> <p><u>IP:</u> <b>EU:</b> Unbound, except <b>NL.</b> In <b>NL:</b> None.</p>

Sector or sub-sector	Description of reservations
<b>Mining</b> (CPC 883, advisory and consulting services only)	<p><u>CSS:</u>  In <b>BE, DE, EE, EL, ES, FI, FR, HR, IE, IT, LV, LU, MT, NL, PL, PT, SI, SE:</b> None.  In <b>AT, BG, CZ, CY, HU, LT, RO, SK:</b> Economic needs test.  In <b>DK:</b> Economic needs test, except for CSS stays of up to three months.</p> <p><u>IP:</u>  In <b>DE, EE, EL, FI, FR, HR, IE, LV, LU, MT, NL, PT, SI, SE:</b> None.  In <b>AT, BE, BG, CZ, CY, DK, ES, HU, IT, LT, PL, RO, SK:</b> Economic needs test.</p>
<b>Maintenance and repair of vessels</b> (part of CPC 8868)	<p><u>CSS:</u>  In <b>BE, EE, EL, ES, FR, HR, IT, LV, LU, NL, PL, PT, SI, SE:</b> None  In <b>AT, BG, CZ, CY, DE, DK, FI, HU, IE, LT, MT, RO, SK:</b> Economic needs test.</p> <p><u>IP:</u>  <b>EU:</b> Unbound, except <b>NL</b>. In <b>NL:</b> None.</p>
<b>Maintenance and repair of rail transport equipment</b> (part of CPC 8868)	<p><u>CSS:</u>  In <b>BE, EE, EL, ES, FR, HR, IT, LV, LU, MT, NL, PL, PT, SI, SE:</b> None.  In <b>AT, BG, CZ, CY, DE, DK, FI, HU, IE, LT, RO, SK:</b> Economic needs test.</p> <p><u>IP:</u>  <b>EU:</b> Unbound, except <b>NL</b>. In <b>NL:</b> None.</p>
<b>Maintenance and repair of motor vehicles, motorcycles, snowmobiles and road transport equipment</b> (CPC 6112, 6122, part of 8867 and part of 8868)	<p><u>CSS:</u>  In <b>BE, EE, EL, ES, FR, HR, IT, LV, LU, NL, PL, PT, SI, SE:</b> None.  In <b>AT, BG, CZ, CY, DE, DK, FI, HU, IE, LT, MT, RO, SK:</b> Economic needs test.</p> <p><u>IP:</u>  <b>EU:</b> Unbound, except <b>NL</b>. In <b>NL:</b> None.</p>
<b>Maintenance and repair of aircraft and parts thereof</b> (part of CPC 8868)	<p><u>CSS:</u>  In <b>BE, EE, EL, ES, FR, HR, IT, LV, LU, MT, NL, PL, PT, SI, SE:</b> None.  In <b>AT, BG, CZ, CY, DE, DK, FI, HU, IE, LT, RO, SK:</b> Economic needs test.</p> <p><u>IP:</u>  <b>EU:</b> Unbound, except <b>NL</b>. In <b>NL:</b> None.</p>

Sector or sub-sector	Description of reservations
<b>Maintenance and repair of metal products, of (non office) machinery, of (non transport and non office) equipment and of personal and household goods<sup>126</sup></b> (CPC 633, 7545, 8861, 8862, 8864, 8865 and 8866)	<p><u>CSS:</u>            In <b>BE, EE, EL, ES, FR, HR, IT, LV, LU, MT, NL, PL, PT, SI, SE</b>: None.            In <b>AT, BG, CZ, CY, DE, DK, HU, IE, LT, RO, SK</b>: Economic needs test.            In <b>FI</b>: Unbound, except in the context of an after-sales or after-lease contract; for maintenance and repair of personal and household goods (CPC 633): Economic needs test.</p> <p><u>IP:</u>  <b>EU</b>: Unbound, except <b>NL</b>. In <b>NL</b>: None.</p>
<b>Translation and interpretation services</b> (CPC 87905, excluding official or certified activities)	<p><u>CSS:</u>            In <b>BE, CY, DE, EE, EL, ES, FR, HR, IT, LU, MT, NL, PL, PT, SI, SE</b>: None.            In <b>AT, BG, CZ, DK, FI, HU, IE, LT, LV, RO, SK</b>: Economic needs test.</p> <p><u>IP:</u>            In <b>CY, DE, EE, FR, LU, LV, MT, NL, PL, PT, SI, SE</b>: None.            In <b>AT, BE, BG, CZ, DK, EL, ES, FI, HU, IE, IT, LT, RO, SK</b>: Economic needs test.            In <b>HR</b>: Unbound.</p>
<b>Telecommunication services</b> (CPC 7544, advisory and consulting services only)	<p><u>CSS:</u>            In <b>BE, DE, EE, EL, ES, FI, FR, HR, IE, IT, LV, LU, MT, NL, PL, PT, SI, SE</b>: None.            In <b>AT, BG, CZ, CY, HU, LT, RO, SK</b>: Economic needs test.            In <b>DK</b>: Economic needs test, except for CSS stays of up to three months.</p> <p><u>IP:</u>            In <b>DE, EE, EL, FI, FR, HR, IE, LV, LU, MT, NL, PL, PT, SI, SE</b>: None.            In <b>AT, BE, BG, CZ, CY, DK, ES, HU, IT, LT, RO, SK</b>: Economic needs test.</p>
<b>Postal and courier services</b> (CPC 751, advisory and consulting services only)	<p><u>CSS:</u>            In <b>BE, DE, EE, EL, ES, FR, HR, IE, IT, LV, LU, MT, NL, PL, PT, SI, SE</b>: None.            In <b>AT, BG, CZ, CY, FI, HU, LT, RO, SK</b>: Economic needs test.            In <b>DK</b>: Economic needs test, except for CSS stays of up to three months.</p> <p><u>IP:</u>            In <b>DE, EE, EL, FR, HR, IE, LV, LU, MT, NL, PL, PT, SI, SE</b>: None.            In <b>AT, BE, BG, CZ, CY, DK, ES, FI, HU, IT, LT, RO, SK</b>: Economic needs test.</p>

<sup>126</sup> Maintenance and repair services of office machinery and equipment including computers (CPC 845) are under computer services.

Sector or sub-sector	Description of reservations
<p><b>Construction and related engineering services</b> (CPC 511, 512, 513, 514, 515, 516, 517 and 518. BG: CPC 512, 5131, 5132, 5135, 514, 5161, 5162, 51641, 51643, 51644, 5165 and 517)</p>	<p><u>CSS:</u>  <b>EU:</b> Unbound except in <b>BE, CZ, DK, ES, NL</b> and <b>SE</b>.  In <b>BE, DK, ES, NL, SE:</b> None.  In <b>CZ:</b> Economic needs test.</p> <p><u>IP:</u>  <b>EU:</b> Unbound, except <b>NL</b>. In <b>NL:</b> None.</p>
<p><b>Site investigation work</b> (CPC 5111)</p>	<p><u>CSS:</u>  In <b>BE, DE, EE, EL, ES, FR, HR, IE, IT, LU, MT, NL, PL, PT, SI, SE:</b> None.  In <b>AT, BG, CZ, CY, FI, HU, LT, LV, RO, SK:</b> Economic needs test.  In <b>DK:</b> Economic needs test, except for CSS stays of up to three months.</p> <p><u>IP:</u>  <b>EU:</b> Unbound.</p>
<p><b>Higher education services</b> (CPC 923)</p>	<p><u>CSS:</u>  <b>EU</b> except in <b>LU, SE:</b> Unbound.  In <b>LU:</b> Unbound, except for university professors, where: None.  In <b>SE:</b> None, except for publicly funded and privately funded educational services suppliers with some form of State support, where: Unbound.</p> <p><u>IP:</u>  <b>EU</b> except in <b>SE:</b> Unbound.  In <b>SE:</b> None, except for publicly funded and privately funded educational services suppliers with some form of State support, where: Unbound.</p>
<p><b>Agriculture, hunting and forestry</b> (CPC 881, advisory and consulting services only)</p>	<p><u>CSS:</u>  <b>EU</b> except in <b>BE, DE, DK, ES, FI, HR</b> and <b>SE:</b> Unbound  In <b>BE, DE, ES, HR, SE:</b> None  In <b>DK:</b> Economic needs test.  In <b>FI:</b> Unbound, except for advisory and consulting services relating to forestry, where: None.</p> <p><u>IP:</u>  <b>EU:</b> Unbound.</p>
<p><b>Environmental services</b> (CPC 9401, 9402, 9403, 9404, part of 94060, 9405, part of 9406 and 9409)</p>	<p><u>CSS:</u>  In <b>BE, EE, ES, FI, FR, HR, IE, IT, LU, MT, NL, PL, PT, SI, SE:</b> None.  In <b>AT, BG, CZ, CY, DE, DK, EL, HU, LT, LV, RO, SK:</b> Economic needs test.</p> <p><u>IP:</u>  <b>EU:</b> Unbound.</p>



Sector or sub-sector	Description of reservations
<b>Insurance and insurance related services</b> (advisory and consulting services only)	<p><u>CSS:</u>            In <b>BE, DE, EE, EL, ES, FR, HR, IE, IT, LV, LU, MT, NL, PL, PT, SI, SE</b>: None.            In <b>AT, BG, CZ, CY, FI, LT, RO, SK</b>: Economic needs test.            In <b>DK</b>: Economic needs test except for CSS stays of up to three months.            In <b>HU</b>: Unbound.</p> <p><u>IP:</u>            In <b>DE, EE, EL, FR, HR, IE, LV, LU, MT, NL, PT, SI, SE</b>: None.            In <b>AT, BE, BG, CZ, CY, DK, ES, FI, IT, LT, PL, RO, SK</b>: Economic needs test.            In <b>HU</b>: Unbound.</p>
<b>Other financial services</b> (advisory and consulting services only)	<p><u>CSS:</u>            In <b>BE, DE, ES, EE, EL, FR, HR, IE, IT, LV, LU, MT, NL, PL, PT, SI, SE</b>: None.            In <b>AT, BG, CZ, CY, FI, LT, RO, SK</b>: Economic needs test.            In <b>DK</b>: Economic needs test, except for CSS that stays of up to three months.            In <b>HU</b>: Unbound.</p> <p><u>IP:</u>            In <b>DE, EE, EL, FR, HR, IE, LV, LU, MT, NL, PT, SI, SE</b>: None.            In <b>AT, BE, BG, CZ, CY, DK, ES, FI, IT, LT, PL, RO, SK</b>: Economic needs test.            In <b>HU</b>: Unbound.</p>
<b>Transport</b> (CPC 71, 72, 73, and 74, advisory and consulting services only)	<p><u>CSS:</u>            In <b>DE, EE, EL, ES, FI, FR, HR, IE, IT, LV, LU, MT, NL, PL, PT, SI, SE</b>: None.            In <b>AT, BG, CZ, CY, HU, LT, RO, SK</b>: Economic needs test.            In <b>DK</b>: Economic needs test, except for CSS stays of up to three months.            In <b>BE</b>: Unbound.</p> <p><u>IP:</u>            In <b>CY, DE, EE, EL, FI, FR, HR, IE, LV, LU, MT, NL, PT, SI, SE</b>: None.            In <b>AT, BG, CZ, DK, ES, HU, IT, LT, RO, SK</b>: Economic needs test.            In <b>PL</b>: Economic needs test, except for air transport, where: None.            In <b>BE</b>: Unbound.</p>

Sector or sub-sector	Description of reservations
<b>Travel agencies and tour operators services</b> (including tour managers <sup>127</sup> ) (CPC 7471)	<p><u>CSS:</u> In <b>AT, CY, CZ, DE, EE, ES, FR, HR, IT, LU, NL, PL, SI, SE</b>: None. In <b>BG, EL, FI, HU, LT, LV, MT, PT, RO, SK</b>: Economic needs test. In <b>DK</b>: Economic needs test, except for CSS stays of up to three months. In <b>BE, IE</b>: Unbound, except for tour managers, where: None.</p> <p><u>IP:</u> <b>EU</b>: Unbound.</p>
<b>Tourist guides services</b> (CPC 7472)	<p><u>CSS:</u> In <b>NL, PT, SE</b>: None. In <b>AT, BE, BG, CY, CZ, DE, DK, EE, FI, FR, EL, HU, IE, IT, LV, LU, MT, RO, SK, SI</b>: Economic needs test. In <b>ES, HR, LT, PL</b>: Unbound.</p> <p><u>IP:</u> <b>EU</b>: Unbound.</p>
<b>Manufacturing</b> (CPC 884, and 885, advisory and consulting services only)	<p><u>CSS:</u> In <b>BE, DE, EE, EL, ES, FI, FR, HR, IE, IT, LV, LU, MT, NL, PL, PT, SI, SE</b>: None. In <b>AT, BG, CZ, CY, HU, LT, RO, SK</b>: Economic needs test. In <b>DK</b>: Economic needs test, except for CSS stays of up to three months.</p> <p><u>IP:</u> In <b>DE, EE, EL, FI, FR, HR, IE, LV, LU, MT, NL, PT, SI, SE</b>: None. In <b>AT, BE, BG, CZ, CY, DK, ES, HU, IT, LT, PL, RO, SK</b>: Economic needs test.</p>

13. The United Kingdom's reservations are:

Sector or sub-sector	Description of reservations
<b>All sectors</b>	None
<b>Legal advisory services in respect of public international law and home jurisdiction law</b> (part of CPC 861)	<p><u>CSS:</u> None.</p> <p><u>IP:</u> None.</p>

<sup>127</sup> Services suppliers whose function is to accompany a tour group of a minimum of 10 natural persons, without acting as guides in specific locations.

Sector or sub-sector	Description of reservations
<b>Accounting and bookkeeping services</b> (CPC 86212 other than "auditing services", 86213, 86219 and 86220)	<u>CSS:</u> None.  <u>IP:</u> Unbound.
<b>Taxation advisory services</b> (CPC 863) <sup>128</sup>	<u>CSS:</u> None.  <u>IP:</u> Unbound.
<b>Architectural services</b> and  <b>Urban planning and landscape architectural services</b> (CPC 8671 and 8674)	<u>CSS:</u> None.  <u>IP:</u> None.
<b>Engineering services</b> and  <b>Integrated engineering services</b> (CPC 8672 and 8673)	<u>CSS:</u> None.  <u>IP:</u> None.
<b>Medical (including psychologists) and dental services</b> (CPC 9312 and part of 85201)	<u>CSS:</u> Unbound.  <u>IP:</u> Unbound.
<b>Veterinary services</b> (CPC 932)	<u>CSS:</u> Unbound.  <u>IP:</u> Unbound.

---

<sup>128</sup> Does not include legal advisory and legal representational services on tax matters, which are under legal advisory services in respect of public international law and home jurisdiction law.

Sector or sub-sector	Description of reservations
<b>Midwives services</b> (part of CPC 93191)	<u>CSS:</u> Unbound.  <u>IP:</u> Unbound.
<b>Services provided by nurses, physiotherapists and paramedical personnel</b> (part of CPC 93191)	<u>CSS:</u> Unbound.  <u>IP:</u> Unbound.
<b>Computer and related services</b> (CPC 84)	<u>CSS:</u> <b>UK:</b> None.  <u>IP:</u> None.
<b>Research and development Services</b> (CPC 851, 852 excluding psychologists services <sup>129</sup> , and 853)	<u>CSS:</u> None  <u>IP:</u> None
<b>Advertising services</b> (CPC 871)	<u>CSS:</u> None.  <u>IP:</u> Unbound.
<b>Market research and opinion polling services</b> (CPC 864)	<u>CSS:</u> None.  <u>IP:</u> None.
<b>Management consulting services</b> (CPC 865)	<u>CSS:</u> None.  <u>IP:</u> None.

---

<sup>129</sup> Part of CPC 85201, which is under medical and dental services.

Sector or sub-sector	Description of reservations
<b>Services related to management consulting</b> (CPC 866)	<u>CSS:</u> None.  <u>IP:</u> None.
<b>Technical testing and analysis services</b> (CPC 8676)	<u>CSS:</u> None.  <u>IP:</u> Unbound.
<b>Related scientific and technical consulting services</b> (CPC 8675)	<u>CSS:</u> None.  <u>IP:</u> Unbound.
<b>Mining</b> (CPC 883, advisory and consulting services only)	<u>CSS:</u> None.  <u>IP:</u> None.
<b>Maintenance and repair of vessels</b> (part of CPC 8868)	<u>CSS:</u> None  <u>IP:</u> Unbound.
<b>Maintenance and repair of rail transport equipment</b> (part of CPC 8868)	<u>CSS:</u> None.  <u>IP:</u> Unbound.
<b>Maintenance and repair of motor vehicles, motorcycles, snowmobiles and road transport equipment</b> (CPC 6112, 6122, part of 8867 and part of 8868)	<u>CSS:</u> None.  <u>IP:</u> Unbound.

Sector or sub-sector	Description of reservations
<b>Maintenance and repair of aircraft and parts thereof</b> (part of CPC 8868)	<u>CSS:</u> None.  <u>IP:</u> Unbound.
<b>Maintenance and repair of metal products, of (non office) machinery, of (non transport and non office) equipment and of personal and household goods<sup>130</sup></b> (CPC 633, 7545, 8861, 8862, 8864, 8865 and 8866)	<u>CSS:</u> None.  <u>IP:</u> Unbound.
<b>Translation and interpretation services</b> (CPC 87905, excluding official or certified activities)	<u>CSS:</u> None.  <u>IP:</u> None.
<b>Telecommunication services</b> (CPC 7544, advisory and consulting services only)	<u>CSS:</u> None.  <u>IP:</u> None.
<b>Postal and courier services</b> (CPC 751, advisory and consulting services only)	<u>CSS:</u> None.  <u>IP:</u> None.
<b>Construction and related engineering services</b> (CPC 511, 512, 513, 514, 515, 516, 517 and 518. BG: CPC 512, 5131, 5132, 5135, 514, 5161, 5162, 51641, 51643, 51644, 5165 and 517)	<u>CSS:</u> Unbound.  <u>IP:</u> Unbound.

<sup>130</sup> Maintenance and repair services of office machinery and equipment including computers (CPC 845) are under computer services.

Sector or sub-sector	Description of reservations
<b>Site investigation work</b> (CPC 5111)	<u>CSS:</u> None.  <u>IP:</u> Unbound.
<b>Higher education services</b> (CPC 923)	<u>CSS:</u> Unbound.  <u>IP:</u> Unbound.
<b>Agriculture, hunting and forestry</b> (CPC 881, advisory and consulting services only)	<u>CSS:</u> Unbound  <u>IP:</u> Unbound.
<b>Environmental services</b> (CPC 9401, 9402, 9403, 9404, part of 94060, 9405, part of 9406 and 9409)	<u>CSS:</u> None.  <u>IP:</u> Unbound.
<b>Insurance and insurance related services</b> (advisory and consulting services only)	<u>CSS:</u> None.  <u>IP:</u> None.
<b>Other financial services</b> (advisory and consulting services only)	<u>CSS:</u> None.  <u>IP:</u> None.
<b>Transport</b> (CPC 71, 72, 73, and 74, advisory and consulting services only)	<u>CSS:</u> None.  <u>IP:</u> None.

Sector or sub-sector	Description of reservations
<b>Travel agencies and tour operators services</b> (including tour managers <sup>131</sup> ) (CPC 7471)	<u>CSS:</u> None.  <u>IP:</u> Unbound.
<b>Tourist guides services</b> (CPC 7472)	<u>CSS:</u> None.  <u>IP:</u> Unbound.
<b>Manufacturing</b> (CPC 884, and 885, advisory and consulting services only)	<u>CSS:</u> None.  <u>IP:</u> None.

---

<sup>131</sup> Services suppliers whose function is to accompany a tour group of a minimum of 10 natural persons, without acting as guides in specific locations.



## ANNEX SERVIN-5: MOVEMENT OF NATURAL PERSONS

### Article 1: Entry and temporary stay-related procedural commitments

The Parties shall endeavour to ensure that the processing of applications for entry and temporary stay pursuant to their respective commitments in the Agreement follows good administrative practice:

- (a) Each Party shall ensure that fees charged by competent authorities for the processing of applications for entry and temporary stay do not unduly impair or delay trade in services under this Agreement;
- (b) subject to the discretion of the competent authorities of each Party, documents required from an applicant for applications for the grant of entry and temporary stay of short-term visitors for business purposes should be commensurate with the purpose for which they are collected;
- (c) complete applications for the grant of entry and temporary stay shall be processed by the competent authorities of each Party as expeditiously as possible;
- (d) the competent authorities of each Party shall endeavour to provide, without undue delay, information in response to any reasonable request from an applicant concerning the status of an application;
- (e) if the competent authorities of a Party require additional information from an applicant in order to process the application, they shall endeavour to notify, without undue delay, the applicant;
- (f) the competent authorities of each Party shall notify the applicant of the outcome of the application promptly after a decision has been taken;
- (g) if an application is approved, the competent authorities of each Party shall notify the applicant of the period of stay and other relevant terms and conditions;
- (h) if an application is denied, the competent authorities of a Party shall, upon request or upon their own initiative make available to the applicant information on any available review and appeal procedures; and
- (i) each Party shall endeavour to accept and process applications in electronic format.

### Article 2: Additional procedural commitments applying to intra-corporate transferees and their partner, children and family members<sup>132</sup>

1. The competent authorities of each Party shall adopt a decision on an application for an intra-corporate transferee entry or temporary stay or a renewal thereof and notify the decision to the applicant in writing, in accordance with the notification procedures under national law, as soon as possible but not later than 90 days after the date on which the complete application was submitted.

---

<sup>132</sup> Paragraphs 1, 2 and 3 do not apply for the Member States that are not subject to the application of the Directive 2014/66/EU of the European Parliament and of the Council of 15 May 2014 on the conditions of entry and residence of third-country nationals in the framework of an intra-corporate transfer ("ICT Directive").

2. Where the information or documentation supplied in support of the application is incomplete, the competent authorities concerned shall endeavour to notify the applicant within a reasonable period of the additional information that is required and set a reasonable deadline for providing it. The period referred to in paragraph 1 shall be suspended until the competent authorities have received the additional information required.

3. The Union shall extend to family members of natural persons of the United Kingdom, who are intra-corporate transferees to the Union, the right of entry and temporary stay granted to family members of an intra-corporate transferee under Article 19 of Directive 2014/66/EU of the European Parliament and of the Council of 15 May 2014 on the conditions of entry and residence of third-country nationals in the framework of an intra-corporate transfer.

4. The United Kingdom shall allow the entry and temporary stay of partners and dependent children of intra-corporate transferees, as allowed under the United Kingdom's Immigration Rules.

5. The United Kingdom shall allow the partners and dependent children of intra-corporate transferees referred to in paragraph 4 to work for the duration of their visa, in an employed or self-employed capacity, and shall not require them to obtain a work permit.

*ANNEX SERVIN-6: GUIDELINES FOR ARRANGEMENTS ON THE RECOGNITION OF PROFESSIONAL QUALIFICATIONS*

*SECTION A: General Provisions*

***Introduction***

1. This Annex contains guidelines for arrangements on the conditions for the recognition of professional qualifications (“arrangements”), as foreseen by Article SERVIN.5.13 [Professional qualifications].
2. Pursuant to that Article, these guidelines shall be taken into account in the development of joint recommendations by professional bodies or authorities of the Parties (“joint recommendations”).
3. The guidelines are non-binding, non-exhaustive and do not modify or affect the rights and obligations of the Parties under this Agreement. They set out the typical content of arrangements, and provide general indications as to the economic value of an arrangement and the compatibility of the respective professional qualifications regimes.
4. Not all elements of these guidelines may be relevant in all cases and professional bodies and authorities are free to include in their joint recommendations any other element that they consider pertinent for the arrangements of the profession and the professional activities concerned, consistent with this Agreement.
5. The guidelines should be taken into account by the Partnership Council when deciding whether to develop and adopt arrangements. They are without prejudice to its review of the consistency of joint recommendations with Title II [Services and Investment] of Heading One [Trade] of Part Two [Trade, transport and fisheries] and its discretion to take into account the elements it deems relevant, including those contained in joint recommendations.

*SECTION B: Form and Content of an Arrangement*

6. This section sets out the typical content of an arrangement, some of which is not within the remit of the professional bodies or authorities preparing joint recommendations. These aspects constitute, nonetheless, useful information to be taken into account in the preparation of joint recommendations, so that they are better adapted to the possible scope of an arrangement.
7. Matters addressed specifically in this Agreement which apply to arrangements (such as the geographical scope of an arrangement, its interaction with scheduled non-conforming measures, the system of dispute resolution, appeal mechanisms, monitoring and review mechanisms of the arrangement) should not be addressed by joint recommendations.
8. An arrangement may specify different mechanisms for the recognition of professional qualifications within a Party. It may also be limited, but not necessarily so, to setting the scope of the arrangement, the procedural provisions, the effects of recognition and additional requirements, and the administrative arrangements.
9. An arrangement which is adopted by the Partnership Council should reflect the degree of discretion that is intended to be preserved for competent authorities deciding on recognition.

***Scope of an Arrangement***

10. The arrangement should set out:
- (a) the specific regulated profession(s), relevant professional title(s) and the activity or group of activities covered by the scope of practice of the regulated profession in both Parties (“scope of practice”); and
  - (b) whether it covers the recognition of professional qualifications for the purpose of access to professional activities on a fixed-term or an indefinite basis.

#### ***Conditions for recognition***

11. The arrangement may specify in particular:
- (a) the professional qualifications necessary for recognition under the arrangement (for example, evidence of formal qualification, professional experience, or other attestation of competence);
  - (b) the degree of discretion preserved by recognition authorities when assessing requests for recognition of these qualifications; and
  - (c) the procedures to deal with variations and gaps between professional qualifications and means to bridge the differences, including the possibility for imposing any compensatory measures or any other relevant conditions and limitations.

#### ***Procedural provisions***

12. The arrangement may set out:
- (a) the documents required and the form in which they should be presented (for example, by electronic or other means, whether they should be supported by translations or certifications of authenticity, etc.);
  - (b) the steps and procedures in the recognition process, including those relating to possible compensatory measures, corresponding obligations and timelines; and
  - (c) the availability of information relevant to all aspects of the recognition processes and requirements.

#### ***Effects of recognition and additional requirements***

13. The arrangement may set out provisions on the effects of recognition (if relevant, also in respect of different modes of supply);

14. The arrangement may describe any additional requirements for the effective exercise of the regulated profession in the host Party. Such requirements may include:

- (a) registration requirements with local authorities;
- (b) appropriate language skills;
- (c) proof of good character;
- (d) compliance with the requirements of the host Party for use of trade or firm names;

- (e) compliance with the rules of ethics, independence and professional conduct requirements of the host Party;
- (f) need to obtain professional indemnity insurance;
- (g) rules on disciplinary action, financial responsibility and professional liability; and
- (h) requirements for continuous professional development.

### ***Administration of the arrangement***

15. The arrangement should set out the terms under which it can be reviewed or revoked, and the effects of any revision or revocation. Consideration may also be given to the inclusion of provisions concerning the effects of any recognition previously accorded.

### *SECTION C: Economic value of an envisaged arrangement*

16. Pursuant to Article SERVIN 5.13(2) [Professional qualifications], joint recommendations shall be supported by an evidence-based assessment of the economic value of an envisaged arrangement. This may consist of an evaluation of the economic benefits that an arrangement is expected to bring to the economies of both Parties. Such an assessment may assist the Partnership Council when developing and adopting an arrangement.

17. Aspects such as the existing level of market openness, industry needs, market trends and developments, client expectations and requirements and business opportunities would constitute useful elements.

18. The evaluation is not required to be a full and detailed economic analysis, but should provide an explanation of the interest of the profession in, and the expected benefits for the Parties ensuing from, the adoption of an arrangement.

### *SECTION D: Compatibility of respective professional qualification regimes*

19. Pursuant to Article SERVIN 5.13(2) [Professional qualifications], joint recommendations shall be supported by an evidence-based assessment of the compatibility of the respective professional qualification regimes. This assessment may assist the Partnership Council when developing and adopting an arrangement.

20. The following process aims at guiding professional bodies and authorities when assessing the compatibility of the respective professional qualifications and activities with a view to simplifying and facilitating the recognition of professional qualifications.

#### Step One: Assessment of the scope of practice and the professional qualifications required to practise the regulated profession in each Party.

21. The assessment of the scope of practice and of the professional qualifications required to practise a regulated profession in each of the Parties should be based on all relevant information.

22. The following elements should be identified:

- (a) activities or groups of activities covered by the scope of practice of the regulated profession in each Party; and

- (b) the professional qualifications required in each Party to practise the regulated profession, which may include any of the following elements:
  - (i) the minimum education required, for example, entry requirements, level of education, length of study and contents of study;
  - (ii) the minimum professional experience required, for example, location, length and conditions of practical training or supervised professional practice prior to registration, licensing or equivalent;
  - (iii) examinations passed, especially examinations of professional competency; and
  - (iv) obtention the acquisition of a licence, or equivalent, certifying, inter alia, the fulfilment of the necessary professional qualification requirements for the pursuit of the profession.

Step Two: Evaluation of the divergence between the scope of practice of, or the professional qualifications required to practise, the regulated profession in each Party.

23. The evaluation of the divergence in the scope of practice of, or in the professional qualifications required to practise, the regulated profession, in each Party, should in particular identify divergence that is substantial.

24. Substantial divergence in the scope of practice may exist if all of the following conditions are met:

- (a) one or more activities covered by a regulated profession in the host Party are not covered by the corresponding profession in the Party of origin;
- (b) such activities are subject to specific training in the host Party;
- (c) the training for such activities in the host Party covers matters substantially diverging from those covered by the applicant's qualification.

25. Substantial divergence in the professional qualifications required to practise a regulated profession may exist if there are divergences in the Parties' requirements with regard to the level, duration or content of the training that is required for the pursuit of activities covered by the regulated profession.

Step Three: Recognition mechanisms

26. There may be different mechanisms for the recognition of professional qualifications, depending on the circumstances. There may be different mechanisms within a Party.

27. If there is no substantial divergence in the scope of practice and in the professional qualifications required to practise a regulated profession, an arrangement may provide for a simpler, more streamlined recognition process than would be the case where substantial divergence exists.

28. If there is substantial divergence, the arrangement may provide for compensatory measures which are sufficient to remedy such divergence.

29. Where compensatory measures are used to reduce substantial divergence, they should be proportionate to the divergence that they seek to address. Any practical professional experience or

formally validated training could be taken into account to assess the extent of the compensatory measures needed.

30. Whether or not the divergence is substantial, the arrangement may take account of the degree of discretion that is intended to be preserved for competent authorities deciding on recognition requests.

31. Compensatory measures may take different forms, including:

- (a) a period of supervised practice of a regulated profession in the host Party, possibly accompanied by further training, under the responsibility of a qualified person and subject to a regulated assessment;
- (b) a test made or recognised by the relevant authorities of the host Party to assess the applicant's ability to practice a regulated profession in that Party; or
- (c) a temporary limitation of the scope of practice; or a combination of those.

32. The arrangement could envisage that a choice be given to applicants between different compensatory measures where this could limit the administrative burden for applicants and such measures are equivalent.

## *ANNEX PPROC-1: PUBLIC PROCUREMENT*

### *SECTION A: Relevant provisions of the GPA:*

Articles I to III, IV.1.a, IV.2 to IV.7, VI to XV, XVI.1 to XVI.3, XVII and XVIII.

### *SECTION B: Market access commitments*

For the purposes of this Section, "CPC" means the Provisional Central Product Classification (Statistical Papers, Series M No. 77, Department of International Economic and Social Affairs, Statistical Office of the United Nations, New York, 1991).

#### Sub-section B1: European Union

In accordance with Articles PPROC 2.2 and PPROC 2.3, Title VI [PUBLIC PROCUREMENT] of Heading One of Part Two applies, in addition to the procurement covered by the annexes of the European Union to Appendix I to the GPA, to the procurement covered by this Sub-section.

The Notes in Annexes 1 to 7 of the European Union to Appendix I to the GPA also apply to the procurement covered by this Sub-section, unless otherwise provided for in this Sub-section.

#### Procurement covered by this Sub-section

##### 1. Additional procuring entities

Procurement of goods and services as set out in Annexes 4 to 6 of the European Union to Appendix I to the GPA, and in paragraph 2 of this Sub-section, by the following procuring entities of the Member States:

- (a) all contracting entities whose procurement is covered by the EU utilities directive which are contracting authorities (e.g. those covered under Annex 1 and Annex 2 to Appendix I to the GPA) or public undertakings<sup>133</sup> and which have as one of their activities
  - (i) the provision or operation of fixed networks intended to provide a service to the public in connection with the production, transport or distribution of gas or heat or the supply of gas or heat to such networks, or

---

<sup>133</sup> According to the EU utilities directive, a public undertaking is any undertaking over which the contracting authorities may exercise directly or indirectly a dominant influence by virtue of their ownership of it, their financial participation therein, or the rules which govern it.

A dominant influence on the part of the contracting authorities shall be presumed when these authorities, directly or indirectly, in relation to an undertaking:

- i. hold the majority of the undertaking's subscribed capital, or
- ii. control the majority of the votes attaching to shares issued by the undertaking, or
- iii. can appoint more than half of the undertaking's administrative, management or supervisory body.



- (ii) any combination between such activity and those referred to in Annex 3 to Appendix I to the GPA;
- (b) privately-owned procuring entities that have as one of their activities any of those referred to in point (a) of this paragraph, in point 1 of Annex 3 to Appendix I to the GPA, or any combination thereof and operate on the basis of special or exclusive rights granted by a competent authority of a Member State;

with regard to procurement equal to or above the following thresholds:

- 400,000 SDR for procurement of goods and services
- 5,000,000 SDR for procurement of construction services (CPC 51).

## 2. Additional services

Procurement of the following services, in addition to the services listed under Annex 5 of the European Union to Appendix I to the GPA, for entities covered under Annexes 1 to 3 of the European Union to Appendix I to the GPA or under paragraph 1 of this Sub-section:

- Hotel and restaurant services (CPC 641);
- Food serving services (CPC 642);
- Beverage serving services (CPC 643);
- Telecommunication related services (CPC 754);
- Real estate services on a fee or contract basis (CPC 8220);
- Other business services (CPC 87901, 87903, 87905-87907);
- Education services (CPC 92).

### Notes

1. Hotel and restaurant services (CPC 641), food serving services (CPC 642), beverage serving services (CPC 643) and education services (CPC 92) contracts are included under the national treatment regime for the suppliers, including service providers, of the United Kingdom, provided that their value equals or exceeds EUR 750,000 when they are awarded by procuring entities covered under Annexes 1 and 2 of the European Union to Appendix I to the GPA and that their value equals or exceeds EUR 1,000,000 when they are awarded by procuring entities covered under Annex 3 of the European Union to Appendix I to the GPA or by procuring entities covered by paragraph 1 of this Sub-section.

2. The supply of gas or heat to networks which provide a service to the public by a procuring entity other than a contracting authority shall not be considered as an activity within the meaning of this Sub-section where:

- (a) the production of gas or heat by the entity concerned takes place because its consumption is necessary for carrying out an activity other than that referred to in this Sub-section or in paragraphs (a) to (f) of Annex 3 of the European Union to Appendix I to the GPA; and

(b) the supply to the public network is aimed only at the economic exploitation of such production and amounts to not more than 20 % of the entity's turnover on the basis of the average for the preceding three years, including the current year.

3. Title VI [PUBLIC PROCUREMENT] of Heading One of Part Two and this Annex do not cover procurement of the following services:

- (a) Human health services (CPC 931);
- (b) Administrative healthcare services (CPC 91122); and
- (c) Supply services of nursing personnel and supply services of medical personnel (CPC 87206 and CPC 87209).

#### Sub-section B2: United Kingdom

In accordance with Articles PPROC 2.2 and PPROC 2.3, Title VI [PUBLIC PROCUREMENT] of Heading One of Part Two applies, in addition to the procurement covered by Article II of the GPA, to the procurement covered by this Sub-section.

The Notes in Annexes 1 to 7 of the United Kingdom to Appendix I to the GPA also apply to the procurement covered by this Sub-section, unless otherwise provided for in this Sub-section.

#### Procurement covered by this Sub-section

1. Additional procuring entities

Procurement of goods and services as set out in Annexes 4 to 6 of the United Kingdom's Appendix I to the GPA, and in paragraph 2 of this Sub-section, by the following procuring entities of the United Kingdom:

(a) all contracting entities whose procurement is covered by the Utilities Contracts Regulation 2016 and the Utilities Contracts (Scotland) Regulations 2016 which are contracting authorities (e.g. those covered under Annex 1 and Annex 2 to Appendix I to the GPA) or public undertakings (see Note:1) and which have as one of their activities

- (i) the provision or operation of fixed networks intended to provide a service to the public in connection with the production, transport or distribution of gas or heat or the supply of gas or heat to such networks, or
- (ii) any combination between such activity and those referred to in Annex 3 to Appendix I to the GPA;

(b) privately-owned procuring entities that have as one of their activities any of those referred to in point (a) of this paragraph, in point 1 of Annex 3 to Appendix I to the GPA, or any combination thereof and operate on the basis of special or exclusive rights granted by a competent authority of the United Kingdom;

with regard to procurement equal to or above the following thresholds:

- 400,000 SDR for procurement of goods and services

- 5,000,000 SDR for procurement of construction services (CPC 51).

Notes to paragraph 1:

1. According to the Utilities Contracts Regulations 2016, a "public undertaking" means any undertaking over which contracting authorities may exercise directly or indirectly a dominant influence by virtue of:

- (a) their ownership of that undertaking;
- (b) their financial participation in that undertaking; or
- (c) the rules which govern that undertaking.

2. According to the Utilities Contracts (Scotland) Regulations 2016, a "public undertaking" means a person over which one or more contracting authorities are able to exercise, directly or indirectly, a dominant influence by virtue of one or more of the following:

- (a) their ownership of that person;
- (b) their financial participation in that person;
- (c) the rights accorded to them by the rules which govern that person.

3. According to both the Utilities Contracts Regulations 2016 and the Utilities Contracts (Scotland) Regulations 2016, a dominant influence on the part of contracting authorities is presumed in any of the following cases in which those authorities, directly or indirectly:

- (a) hold the majority of the undertaking's subscribed capital;
- (b) control the majority of the votes attaching to shares issued by the undertaking;
- (c) can appoint more than half of the undertaking's administrative, management or supervisory body.

## 2. Additional services

Procurement of the following services, in addition to the services listed under Annex 5 of the United Kingdom to Appendix I to the GPA, for entities covered under Annexes 1 to 3 of the United Kingdom to Appendix I to the GPA or under paragraph 1 of this Sub-section:

- Hotel and restaurant services (CPC 641);
- Food serving services (CPC 642);
- Beverage serving services (CPC 643);
- Telecommunication related services (CPC 754);
- Real estate services on a fee or contract basis (CPC 8220);
- Other business services (CPC 87901, 87903, 87905-87907);

- Education services (CPC 92).

Notes

1. Hotel and restaurant services (CPC 641), food serving services (CPC 642), beverage serving services (CPC 643) and education services (CPC 92) contracts are included under the national treatment regime for the suppliers, including service providers, of the European Union, provided that their value equals or exceeds GBP 663,540 when they are awarded by procuring entities covered under Annexes 1 and 2 of the United Kingdom to Appendix I to the GPA and that their value equals or exceeds GBP 884,720 when they are awarded by procuring entities covered under Annex 3 of the United Kingdom to Appendix I to the GPA or by procuring entities covered by paragraph 1 of this Section.

2. The supply of gas or heat to networks which provide a service to the public by a procuring entity other than a contracting authority shall not be considered as an activity within the meaning of this Section where:

- (a) the production of gas or heat by the entity concerned takes place because its consumption is necessary for carrying out an activity other than that referred to in this Section or in paragraphs (a) to (f) of Annex 3 of the United Kingdom to Appendix I to the GPA; and
- (b) the supply to the public network is aimed only at the economic exploitation of such production and amounts to not more than 20% of the entity's turnover on the basis of the average for the preceding three years, including the current year.

3. Title VI [PUBLIC PROCUREMENT] of Heading One of Part Two and this Annex do not cover procurement of the following services:

- (a) Human health services (CPC 931);
- (b) Administrative healthcare services (CPC 91122); and
- (c) Supply services of nursing personnel and supply services of medical personnel (CPC 87206 and CPC 87209).

*ANNEX ENER-1: LISTS OF ENERGY GOODS, HYDROCARBONS AND RAW MATERIALS*

LIST OF ENERGY GOODS BY HS CODE

- Natural gas, including liquefied natural gas, liquefied petroleum gas (LPG) (HS code 27.11)
- Electrical energy (HS code 27.16)
- Crude oil and oil products (HS code 27.09 - 27.10, 27.13-27.15)
- Solid fuels (HS code 27.01, HS code 27.02, HS code 27.04)
- Fuel wood and wood charcoal (HS code 44.01 and HS code 44.02 goods used for energy)
- Biogas (HS code 38.25)

LIST OF HYDROCARBONS BY HS CODE

- Crude oil (HS code 27.09)
- Natural gas (HS code 27.11)

LIST OF RAW MATERIALS BY HS CHAPTER

Chapter	Heading
25	Salt; sulphur; earths and stone; plastering materials, lime and cement
26	Ores, slag and ash, with the exception of uranium or thorium ores or concentrates (HS code 26.12)
27	Mineral fuels, mineral oils and products of their distillation; bituminous substances; mineral waxes
28	Inorganic chemicals; organic or inorganic compounds of precious metals, of rare-earth metals; of radioactive elements or of isotopes, with the exception of radioactive chemical elements and radioactive isotopes (including the fissile or fertile chemical elements and isotopes) and their compounds; mixtures and residues containing these products (HS code 28.44); and isotopes other than those of heading no. 28.44; compounds, inorganic or organic, of such isotopes, whether or not chemically defined (HS code 28.45)
29	Organic chemicals
31	Fertilisers
71	Natural or cultured pearls, precious or semi-precious stones, precious metals, metals clad with precious metal, and articles thereof, with the exception of pearls, natural or cultured, whether or not worked or graded but not strung, mounted or set; pearls, natural or cultured, temporarily strung for the convenience of transport (HS code 7101)
72	Iron and steel
74	Copper and articles thereof
75	Nickel and articles thereof
76	Aluminium and articles thereof

78	Lead and articles thereof
79	Zinc and articles thereof
80	Tin and articles thereof
81	Other base metals; cermets; articles thereof

## ANNEX ENER-2: ENERGY AND ENVIRONMENTAL SUBSIDIES

As part of the principles set out in Article 3.5(14) [Prohibited subsidies and subsidies subject to conditions (Energy and environment)] of Chapter three [Subsidy control] of Title XI [Level playing field for open and fair competition and sustainable development] of Heading One [Trade] of Part Two of this Agreement:

- (1) Subsidies for electricity generation adequacy, renewable energy and cogeneration shall not undermine the ability of a Party to meet its obligations under Article ENER.6 [Provisions relating to wholesale electricity and gas markets] of this Agreement, shall not unnecessarily affect the efficient use of electricity interconnectors provided for under Article ENER.13 [Efficient use of electricity interconnectors], and, without prejudice to Article ENER 6(3) [Provisions relating to wholesale electricity and gas markets] of this Agreement, shall be determined by means of a transparent, non-discriminatory and effective competitive process; and
  - (a) subsidies for electricity generation adequacy shall provide incentives for capacity providers to be available in times of expected system stress and may be limited to installations not exceeding specified CO<sub>2</sub> emission limits; and
  - (b) subsidies for renewable energy and cogeneration shall not affect beneficiaries' obligations or opportunities to participate in electricity markets.
- (2) Notwithstanding point 1, provided that appropriate measures are put in place to prevent overcompensation, non-competitive procedures may be used to grant subsidies for renewable energy and cogeneration if the potential supply is insufficient to ensure a competitive process, the eligible capacity is unlikely to have a material effect on trade or investment between the Parties, or subsidies are granted for demonstration projects.
- (3) If partial exemptions from energy-related taxes and levies<sup>134</sup> in favour of energy-intensive users are introduced, such exemptions shall not exceed the total amount of the tax or levy.
- (4) If compensation for electricity-intensive users is granted in the event of an increase in electricity cost resulting from climate policy instruments, it shall be restricted to sectors at significant risk of carbon leakage due to the cost increase.
- (5) Subsidies for the decarbonisation of emissions linked to own industrial activities shall achieve an overall reduction in greenhouse gas emissions. The subsidies shall reduce the emissions directly resulting from the industrial activity. Subsidies for improvements of the energy efficiency of own industrial activities shall improve energy efficiency by reducing energy consumption, either directly or per unit of production.

---

<sup>134</sup> For greater certainty, levies do not include network charges or tariffs.

*ANNEX ENER-3: NON-APPLICATION OF THIRD-PARTY ACCESS AND OWNERSHIP UNBUNDLING TO INFRASTRUCTURE*

A Party may decide not to apply Article ENER.8 [Third-party access to transmission and distribution networks] and Article ENER.9 [System operation and unbundling of transmission network operators] to new infrastructure or to a significant expansion of existing infrastructure where:

- (a) the risk attached to the investment in the infrastructure is such that the investment would not take place unless an exemption is granted;
- (b) the investment enhances competition or security of supply;
- (c) the infrastructure is owned by a natural or legal person separate, at least in terms of its legal form, from the system operators in whose systems it was or is to be built;
- (d) before granting the exemption, the Party has decided on the rules and mechanisms for management and allocation of capacity.



*ANNEX ENER-4: ALLOCATION OF ELECTRICITY INTERCONNECTOR CAPACITY AT THE DAY-AHEAD  
MARKET TIMEFRAME*

**Part 1**

1. The new procedure for the allocation of capacity on electricity interconnectors at the day-ahead market timeframe shall be based on the concept of “Multi-region loose volume coupling”.

The overall objective of the new procedure shall be to maximise the benefits of trade.

As the first step in developing the new procedure, the Parties shall ensure that transmission system operators prepare outline proposals and a cost-benefit analysis.

2. Multi-region loose volume coupling shall involve the development of a market coupling function to determine the net energy positions (implicit allocation) between:

- (a) bidding zones established in accordance with Regulation (EU) 2019/943, which are directly connected to the United Kingdom by an electricity interconnector; and

- (b) the United Kingdom.

3. The net energy positions over electricity interconnectors shall be calculated via an implicit allocation process by applying a specific algorithm to:

- (a) commercial bids and offers for the day-ahead market timeframe from the bidding zones established in accordance with Regulation (EU) 2019/943 which are directly connected to the United Kingdom by an electricity interconnector;

- (b) commercial bids and offers for the day-ahead market timeframe from relevant day-ahead markets in the United Kingdom;

- (c) network capacity data and system capabilities determined in accordance with the procedures agreed between transmission system operators; and

- (d) data on expected commercial flows of electricity interconnections between bidding zones connected to the United Kingdom and other bidding zones in the Union, as determined by Union transmission system operators using robust methodologies.

This process shall be compatible with the specific characteristics of direct current electricity interconnectors, including losses and ramping requirements.

4. The market coupling function shall:

- (a) produce results sufficiently in advance of the operation of the Parties’ respective day-ahead markets (for the Union this is single day-ahead coupling established in accordance with

Commission Regulation (EU) 2015/1222<sup>135</sup>) in order that such results may be used as inputs into the processes which determine the results in those markets;

- (b) produce results which are reliable and repeatable;
  - (c) be a specific process to link the distinct and separate day-ahead markets in the Union and the United Kingdom; in particular, this means that the specific algorithm shall be distinct and separate from that used in single day-ahead coupling established in accordance with Regulation (EU) 2015/1222 and, in respect of commercial bids and offers of the Union, only have access to those from bidding zones which are directly connected to the United Kingdom by an electricity interconnector.
5. The calculated net energy positions shall be published following validation and verification. If the market coupling function is unable either to operate or to produce a result, electricity interconnector capacity shall be allocated by a fall-back process, and market participants shall be notified that the fall-back process will apply.
6. The costs of developing and implementing the technical procedures shall be equally shared between the relevant United Kingdom transmission system operators or other entities, on the one side, and relevant Union transmission system operators or other entities, on the other side, unless the Specialised Committee on Energy decides otherwise.

## **Part 2**

The timeline for the implementation of this Annex shall be from the entry into force of this Agreement, as follows:

- (a) within 3 months – cost benefit analysis and outline of proposals for technical procedures;
- (b) within 10 months – proposal for technical procedures;
- (c) within 15 months – entry into operation of technical procedures.

---

<sup>135</sup> Commission Regulation (EU) 2015/1222 of 24 July 2015 establishing a guideline on capacity allocation and congestion management (OJ EU L 197, 25.7.2015, p. 24).

## ANNEX AVSAF-1: AIRWORTHINESS AND ENVIRONMENT CERTIFICATION

### SECTION A: General provisions

#### Article 1: Purpose and scope

1. The objective of this Annex is the implementation of cooperation in the following areas, in accordance with Article AVSAF.3(2) [Scope and implementation] of this Agreement, describing the terms, conditions and methods for reciprocal acceptance of findings of compliance and certificates:
  - (a) airworthiness certificates and monitoring of civil aeronautical products referred to in point (a) of Article AVSAF.3(1) [Scope and implementation] of this Agreement;
  - (b) environmental certificates and testing of civil aeronautical products referred to in point (b) of Article AVSAF.3(1) [Scope and implementation] of this Agreement; and
  - (c) design and production certificates and monitoring of design and production organisations referred to in point (c) Article AVSAF.3(1) [Scope and implementation] of this Agreement.
2. Notwithstanding paragraph 1, used civil aeronautical products, other than used aircraft, are excluded from the scope of this Annex.

#### Article 2: Definitions

For the purposes of this Annex, the following definitions apply:

- (a) “acceptance” means the recognition of certificates, approvals, changes, repairs, documents and data of one Party by the other Party without validation activities and without issuing a corresponding certificate by that other Party;
- (b) “authorised release certificate” means a certificate issued by an approved organisation or a competent authority of the exporting Party as a form of recognition that a new civil aeronautical product, other than an aircraft, conforms to a design approved by the exporting Party and is in a condition for safe operation;
- (c) “category of civil aeronautical products” means a set of products sharing common characteristics, as grouped in the technical implementation procedures, on the basis of EASA and UK CAA Certification Specifications;
- (d) “certificating authority” means the technical agent of the exporting Party that issues a design certificate for a civil aeronautical product in its capacity as an authority carrying out the State of Design responsibilities set out in Annex 8 to the Convention on International Civil Aviation. When a design certificate is issued by an approved organisation of the exporting Party, the technical agent of the exporting Party is considered as the certificating authority;
- (e) “design certificate” means a form of recognition by the technical agent or an approved organisation of a Party that the design or change to a design of a civil aeronautical product complies with airworthiness requirements, as applicable, and environmental protection requirements, in particular concerning environmental characteristics set out in laws, regulations and administrative provisions of that Party;

- (f) “design-related operational requirements” means the operational, including environmental, requirements affecting either the design features of the civil aeronautical product or data on the design relating to the operations, or the maintenance of that product, which make it eligible for a particular kind of operation;
- (g) “export” means the process by which a civil aeronautical product is released from the regulatory system for civil aviation safety of a Party to that of the other Party;
- (h) “export certificate of airworthiness” means a certificate issued by the competent authority of the exporting Party or, for used aircraft, by the competent authority of the State of Registry from which the product is exported as a form of recognition that an aircraft conforms to the applicable airworthiness and environmental protection requirements notified by the importing Party;
- (i) “exporting Party” means the Party from whose regulatory system for civil aviation safety a civil aeronautical product is released;
- (j) “import” means the process by which an exported civil aeronautical product from the regulatory system for civil aviation safety of a Party is introduced into that of the other Party;
- (k) “importing Party” means the Party into whose regulatory system for civil aviation safety a civil aeronautical product is introduced;
- (l) “major change” means all changes in type design other than “minor change”;
- (m) “minor change” means a change in type design that has no appreciable effect on the mass, balance, structural strength, reliability, operational characteristics, environmental characteristics, or other characteristics affecting the airworthiness of the civil aeronautical product;
- (n) “operational suitability data” means the required set of data to support and allow the type specific operational aspects of certain types of aircraft that are regulated under the regulatory system for civil aviation safety of the Union or of the United Kingdom. It must be designed by the type certificate applicant or holder for the aircraft and be part of the type certificate. Under the regulatory system for civil aviation safety of the Union or of the United Kingdom, an initial application for a type certificate or restricted type certificate shall include, or be subsequently supplemented by, the application for approval of operational suitability data, as applicable to the aircraft type;
- (o) “production approval” means a certificate issued by the competent authority of a Party to a manufacturer which produces civil aeronautical products, as a form of recognition that the manufacturer complies with applicable requirements set out in laws, regulations and administrative provisions of that Party for the production of the particular civil aeronautical products;
- (p) “technical implementation procedures” means the implementation procedures for this Annex developed by the technical agents of the Parties in accordance with Article AVSAF.3(5) [Scope and implementation] of this Agreement;
- (q) “validating authority” means the technical agent of the importing Party that accepts or validates, as specified in this Annex, a design certificate issued by the certifying authority.

## *SECTION B: Certification Oversight Board*

### Article 3: Establishment and composition

1. The Certification Oversight Board, accountable to the Specialised Committee on Aviation Safety, is hereby established under the co-chairmanship of the technical agents of the Parties, as a technical coordination body responsible for the effective implementation of this Annex. It shall be composed of representatives from the technical agent of each Party and may invite additional participants to facilitate the fulfilment of its mandate.
2. The Certification Oversight Board shall meet at regular intervals upon the request of either technical agent and take decisions and make recommendations by consensus. It shall develop and adopt its rules of procedure.

### Article 4: Mandate

The mandate of the Certification Oversight Board shall include in particular:

- (a) developing, adopting, and revising the technical implementation procedures referred to in Article 6 [Technical implementation procedures];
- (b) sharing information on major safety concerns and, where appropriate, developing action plans to address them;
- (c) resolving technical issues falling within the responsibilities of the competent authorities and affecting the implementation of this Annex;
- (d) where appropriate, developing effective means of cooperation, technical support and exchange of information regarding safety and environmental protection requirements, certification systems, and quality management and standardisation systems;
- (e) conducting periodic reviews on the modalities of validation or acceptance of design certificates set out in Articles 10 [Modalities of the validation of design certificates] and 13 [Acceptance];
- (f) proposing amendments to this Annex to the Specialised Committee on Aviation Safety;
- (g) in accordance with Article 29 [Continued qualifications of the competent authorities], defining procedures to ensure the continued confidence of each Party in the reliability of the other Party's processes for findings of compliance;
- (h) analysing and taking action regarding the implementation of the procedures referred to in point (g); and
- (i) reporting unresolved issues to the Specialised Committee on Aviation Safety and ensuring the implementation of decisions taken by the Specialised Committee on Aviation Safety regarding this Annex.

## *SECTION C: Implementation*

Article 5: Competent authorities for design certification, production certification and export certificates

1. The competent authorities for design certification are:
  - (a) for the Union: the European Union Aviation Safety Agency; and
  - (b) for the United Kingdom: the Civil Aviation Authority of the United Kingdom
2. The competent authorities for production certification and export certificates are:
  - (a) for the Union: the European Union Aviation Safety Agency and the competent authorities of the Member States. As regards an export certificate for used aircraft, it is the competent authority of the State of Registry for the aircraft from which the aircraft is exported; and
  - (b) for the United Kingdom: the Civil Aviation Authority of the United Kingdom.

Article 6: Technical implementation procedures

1. The technical implementation procedures shall be developed by the technical agents of the Parties through the Certification Oversight Board in order to provide specific procedures to facilitate the implementation of this Annex, by defining the procedures for communication activities between the competent authorities of the Parties.
2. The technical implementation procedures shall also address the differences between the Parties' civil aviation standards, rules, practices, procedures and systems related to the implementation of this Annex, as provided for in Article AVSAF.3(5) [Scope and implementation] of this Agreement.

Article 7: Exchange and protection of confidential and proprietary data and information

1. Data and information exchanged in the implementation of this Annex shall be subject to Article AVSAF.11 [Confidentiality and protection of data and information] of this Agreement.
2. Data and information exchanged during the validation process shall be limited in nature and content to what is necessary for the purpose of compliance demonstration with applicable technical requirements, as detailed in the technical implementation procedures.
3. Any disagreement with regard to a data and information exchange between the competent authorities shall be handled as detailed in the technical implementation procedures. Each Party shall retain the right to refer the disagreement to the Certification Oversight Board for resolution.

*SECTION D: Design certification*

Article 8: General principles

1. This Section addresses all design certificates and changes thereto, where applicable, within the scope of this Annex, in particular:
  - (a) type certificates, including restricted type certificates;
  - (b) supplemental type certificates;

- (c) repair design approvals; and
- (d) technical standard order authorisations.

2. The validating authority shall either validate, having regard to the level of involvement referred to in Article 12 [Level of involvement of the validating authority], or accept a design certificate or a change that has been, or is in the process of being, issued or approved by the certificating authority, in accordance with the terms and conditions set out in this Annex and as detailed in the technical implementation procedures, including its modalities of acceptance and validation of certificates.

3. For the implementation of this Annex, each Party shall ensure that, in its regulatory system for civil aviation safety, the capability of any design organisation to assume its responsibilities is sufficiently controlled through a system of certification for design organisations.

#### Article 9: Validation process

1. An application for the validation of a design certificate of a civil aeronautical product shall be made to the validating authority through the certificating authority as detailed in the technical implementation procedures.

2. The certificating authority shall ensure that the validating authority receives all the relevant data and information necessary for the validation of the design certificate, as detailed in the technical implementation procedures.

3. Upon receiving the application for the validation of the design certificate, the validating authority shall determine the certification basis for the validation in accordance with Article 11 [Certification basis for the validation], as well as the level of involvement of the validating authority in the validation process in accordance with Article 12 [Level of involvement of the validating authority].

4. The validating authority shall, as detailed in the technical implementation procedures, base its validation to the maximum extent practicable on the technical evaluations, tests, inspections, and findings of compliance made by the certificating authority.

5. The validating authority shall, after examining relevant data and information provided by the certificating authority, issue its design certificate for the validated civil aeronautical product ("validated design certificate") when:

- (a) it is confirmed that the certificating authority has issued its own design certificate for the civil aeronautical product;
- (b) it has been stated by the certificating authority that the civil aeronautical product complies with the certification basis referred to in Article 11 [Certification basis for the validation];
- (c) all issues raised during the validation process conducted by the validating authority have been resolved; and
- (d) additional administrative requirements, as detailed in the technical implementation procedures, have been met by the applicant.

6. Each Party shall ensure that in order to obtain and maintain a validated design certificate, the applicant holds and retains at the disposal of the certifying authority all relevant design information, drawings and test reports, including inspection records for the certified civil aeronautical product, in order to provide the information necessary to ensure the continued airworthiness and compliance with applicable environmental protection requirements of the civil aeronautical product.

#### Article 10: Modalities of the validation of design certificates

1. Type certificates issued by the technical agent of the Union as certifying authority shall be validated by the technical agent of the United Kingdom as validating authority. The following data shall be subject to acceptance:

- (a) engine installation manual (for engine type certificate);
- (b) structural repair manual;
- (c) instruction for continued airworthiness of electrical wiring interconnection systems; and
- (d) weight balance manual.

By way of technical implementation procedures, procedural detail may be established in respect of acceptance of the relevant data. Any such procedural detail must not affect the requirement of acceptance established in the first subparagraph.

2. Significant supplemental type certificates and approvals for significant major changes issued by the technical agent of the Union as certifying authority shall be validated by the technical agent of the United Kingdom as validating authority. A streamlined validation process limited to the technical familiarisation without the involvement of the validating authority in the showing of compliance activities by the applicant shall be used as a matter of principle, unless otherwise decided by the technical agents on a case-by-case basis.

3. Type certificates issued by the technical agent of the United Kingdom as certifying authority shall be validated by the technical agent of the Union as validating authority.

4. Supplemental type certificates, approvals for major changes, major repairs and technical standard order authorisations issued by the technical agent of the United Kingdom as certifying authority or by an approved organisation under laws and regulations of the United Kingdom shall be validated by the technical agent of the Union as validating authority. A streamlined validation process limited to the technical familiarisation without the involvement of the validating authority in the showing of compliance activities by the applicant may be used when decided by the technical agents on a case-by-case basis.

#### Article 11: Certification basis for the validation

1. For the purpose of validating a design certificate of a civil aeronautical product, the validating authority shall refer to the following requirements set out in laws, regulations and administrative provisions of its Party in determining the certification basis:

- (a) the airworthiness requirements for a similar civil aeronautical product that were in effect on the effective application date established by the certifying authority, and complemented



when applicable by additional technical conditions as detailed in the technical implementation procedures; and

- (b) the environmental protection requirements for the civil aeronautical product that were in effect on the date of the application for the validation to the validating authority.

2. The validating authority shall specify, when applicable, any:

- (a) exemption to the applicable requirements;
- (b) deviation from the applicable requirements; or
- (c) compensating factors that provide an equivalent level of safety when applicable requirements are not complied with.

3. In addition to the requirements set out in paragraphs 1 and 2, the validating authority shall specify any special condition to be applied if the related airworthiness codes, laws, regulations and administrative provisions do not contain adequate or appropriate safety requirements for the civil aeronautical product, because:

- (a) the civil aeronautical product has novel or unusual design features relative to the design practices on which the applicable airworthiness codes, laws, regulations and administrative provisions are based;
- (b) the intended use of the civil aeronautical product is unconventional; or
- (c) experience obtained from other, similar civil aeronautical products in service or civil aeronautical products having similar design features has shown that unsafe conditions may develop.

4. When specifying exemptions, deviations, compensating factors or special conditions, the validating authority shall give due consideration to these applied by the certificating authority and they shall not be more demanding for the civil aeronautical products to be validated than they would be for its own similar products. The validating authority shall notify the certificating authority of any such exemptions, deviations, compensating factors or special conditions.

#### Article 12: Level of involvement of the validating authority

1. The level of involvement of the validating authority of a Party during the validation process referred to in Article 9 [Validation process] and as detailed in the technical implementation procedures, shall be mainly determined by:

- (a) the experience and records of the competent authority of the other Party as certificating authority;
- (b) the experience already gained by that validating authority during previous validation exercises with the competent authority of the other Party;
- (c) the nature of the design to be validated;
- (d) the performance and experience of the applicant with the validating authority; and

(e) the outcome of qualification requirements assessments referred to in Articles 28 [Qualification requirements for the acceptance of findings of compliance and certificates] and Article 29 [Continued qualifications of the competent authorities].

2. The validating authority shall exercise special procedures and scrutiny, in particular regarding the certificating authority's processes and methods, during the first validation of any certificate, where the certificating authority has not previously issued a certificate in the category of civil aeronautical products concerned after 30 September 2004. The procedures and criteria to be applied shall be detailed in the technical implementation procedures.

3. The effective implementation of the principles set out in paragraphs 1 and 2 shall be regularly measured, monitored, reviewed by the Certification Oversight Board, using metrics as detailed in the technical implementation procedures.

#### Article 13: Acceptance

1. For a design certificate subject to acceptance, the validating authority shall accept the design certificate issued by the certificating authority without any validation activities. In that case, the design certificate shall be recognised by the validating authority as equivalent to a certificate issued in accordance with laws, regulations and administrative provisions of its Party and the validating authority shall not issue its corresponding certificate.

2. Non-significant supplemental type certificates, non-significant major changes and technical standard order authorisations issued by the technical agent of the Union as certificating authority or by an approved organisation under Union law shall be accepted by the technical agent of the United Kingdom as validating authority.

3. Minor changes and repairs approved by the technical agent of the Union as certificating authority or by an approved organisation under Union law shall be accepted by the technical agent of the United Kingdom as validating authority.

4. Minor changes and minor repairs approved by the technical agent of the United Kingdom as certificating authority or by an approved organisation under laws and regulations of the United Kingdom shall be accepted by the technical agent of the Union as validating authority.

#### Article 14: Implementation provisions for Articles 10 [Modalities of the validation of design certificates] and 13 [Acceptance]

1. The minor change or major change classifications shall be made by the certificating authority in accordance with the definitions set out in this Annex and interpreted in accordance with the applicable rules and procedures of the certificating authority.

2. For classifying a supplemental type certificate or major change as significant or non-significant, the certificating authority shall consider the change in the context of all previous relevant design changes and all related revisions to the applicable certification specifications incorporated in the type certificate for the civil aeronautical product. Changes that meet either of the following criteria are automatically considered as significant:

(a) the general configuration or the principles of construction are not retained; or

(b) the assumptions used for certification of the product to be changed do not remain valid.

#### Article 15: Existing design certificates

For the purposes of this Annex, the following apply:

- (a) type certificates, supplemental type certificates, approvals for changes and repairs, as well as technical standard order authorisations and changes thereto issued by the technical agent of the Union to United Kingdom applicants, or by an approved design organisation located in the United Kingdom, on the basis of Union law and valid on 31 December 2020 are deemed to have been issued by the technical agent of the United Kingdom as certifying authority or by an approved organisation under the laws and regulations of the United Kingdom and to have been accepted by the technical agent of the Union as validating authority in accordance with Article 13(1) [Acceptance];
- (b) type certificates, supplemental type certificates, approvals for changes and repairs, as well as technical standard order authorisations and changes thereto issued by the technical agent of the Union to Union applicants, or by a design organisation located in the Union, on the basis of Union law and valid on 31 December 2020 are deemed to have been accepted by the technical agent of the United Kingdom as validating authority in accordance with Article 13(1) [Acceptance].

#### Article 16: Transfer of a design certificate

In the event that a design certificate is transferred to another entity, the certifying authority responsible for the design certificate shall promptly notify the validating authority of the transfer and apply the procedure related to the transfer of design certificates as detailed in the technical implementation procedures.

#### Article 17: Design-related operational requirements

1. The technical agents shall ensure that, where necessary, data and information related to design-related operational requirements shall be exchanged during the validation process.
2. Subject to decision by the technical agents for some design-related operational requirements, the validating authority may accept the compliance statement of the certifying authority through the validation process.

#### Article 18: Operational documents and data related to the type

1. Some type-specific sets of operational documents and data, including operational suitability data in the Union system and the equivalent data in the United Kingdom system, provided by the type certificate holder shall be approved or accepted by the certifying authority and, where necessary, exchanged during the validation process.
2. Operational documents and data referred to in paragraph 1 may be either accepted or validated by the validating authority as detailed in the technical implementation procedures.

#### Article 19: Concurrent validation

When decided by the applicant and the technical agents, a concurrent certification and validation process may be used, where appropriate and as detailed in the technical implementation procedures.

## Article 20: Continuing airworthiness

1. The competent authorities shall take action to address unsafe conditions in civil aeronautical products for which they are the certificating authority.
2. Upon request, a competent authority of a Party shall, in respect of civil aeronautical products designed or manufactured under its regulatory system, assist the competent authority of the other Party in determining any action considered to be necessary for the continued airworthiness of the civil aeronautical products.
3. When in-service difficulties or other potential safety issues affecting a civil aeronautical product within the scope of this Annex lead to an investigation conducted by the technical agent of a Party that is the certificating authority for the civil aeronautical product, the technical agent of the other Party shall, upon request, support that investigation, including by providing relevant information reported by relevant entities on failures, malfunctions, defects or other occurrences affecting that civil aeronautical product.
4. The reporting obligations of the design certificate holders to the certificating authority and the information exchange mechanism established under this Annex shall be considered to fulfil the obligation of each design certificate holder to report failures, malfunctions, defects or other occurrences affecting that civil aeronautical product to the validating authority.
5. Actions to address unsafe conditions and exchange of safety information referred to in paragraphs 1 to 4 shall be detailed in the technical implementation procedures.
6. The technical agent of a Party shall keep the technical agent of the other Party informed of all its mandatory continuing airworthiness information in relation to civil aeronautical products designed or manufactured under its oversight system, and which are within the scope of this Annex.
7. Any changes to the airworthiness status of a certificate issued by a Party's technical agent shall be communicated in a timely manner to the other Party's technical agent.

### *SECTION E: Production certification*

#### Article 21: Recognition of production certification and production oversight systems

1. The importing Party shall recognise the production certification and production oversight system of the exporting Party, since the system is considered sufficiently equivalent to the system of the importing Party within the scope of this Annex, subject to the provisions of this Article.
2. The recognition of the production certification and production oversight system of the United Kingdom by the Union is limited to the recognition of the production of categories of civil aeronautical products that were already subject to that system on 31 December 2020, as detailed in the technical implementation procedures.
3. In the event that a new category of civil aeronautical products is added to the exporting Party's production certification and production oversight system, the competent authority of the exporting Party shall notify the technical agent of the importing Party. Before extending the recognition of the production certification and production oversight system to the new category of civil aeronautical products, the technical agent of the importing Party may decide to conduct an assessment to confirm that the production certification and production oversight system of the exporting Party for this category of civil aeronautical products is sufficiently equivalent to the

production certification and production oversight system of the importing Party. That assessment shall be performed as detailed in the technical implementation procedures, and may include an assessment of the production approval holder under the oversight of the competent authority of the exporting Party. The process for the extension of the recognition of the production certification and production oversight system of the exporting Party to the new category of civil aeronautical products by the importing Party shall be detailed in the technical implementation procedures.

4. The recognition of the production certification and production oversight system of the exporting Party by the importing Party shall be subject to the level of safety provided by the production certification and production oversight system of the exporting Party remaining sufficiently equivalent to that provided by the system of the importing Party. The equivalence of the production certification and production oversight system shall be continuously monitored through the procedures set out in Article 29 [Continued qualifications of the competent authorities].

5. Paragraphs 1 to 3 also apply to the production of a civil aeronautical product for which the State of Design responsibilities are exercised by a country other than the exporting Party of the civil aeronautical product, provided that the competent authority of the exporting Party has established and implemented the necessary procedures with the relevant authority of the State of Design to control the interface between the design certificate holder and the production approval holder for that civil aeronautical product.

#### Article 22: Extension of production approval

1. A production approval issued by the competent authority of the exporting Party to a manufacturer primarily located in the territory of that exporting Party and recognised under Article 21(1) [Recognition of production certification and production oversight systems] may be extended to include manufacturing sites and facilities of the manufacturer located in the territory of the other Party or in the territory of a third country, irrespective of the legal status of those manufacturing sites and facilities, and irrespective of the type of civil aeronautical product manufactured in those sites and facilities. In that case, the competent authority of the exporting Party shall remain responsible for the oversight of those manufacturing sites and facilities and the competent authority of the importing Party shall not issue its own production approval to these manufacturing sites and facilities for the same civil aeronautical product.

2. If facilities and manufacturing sites for a manufacturer primarily located in the territory of the exporting Party are located in the other Party, the competent authorities of both Parties shall cooperate with each other, in the framework of Article 32 [Support for certification and continued airworthiness oversight activities], with a view to having the importing Party participating in the oversight activities of the exporting Party in relation to these facilities.

#### Article 23: Interface between the production approval holder and the design certificate holder

1. In cases where the production approval holder for a civil aeronautical product is regulated by the competent authority of a Party, and the design certificate holder for the same civil aeronautical product is regulated by the competent authority of the other Party, the competent authorities of the Parties shall establish procedures to define the responsibilities of each Party to control the interface between the production approval holder and the design certificate holder.

2. For the purpose of export of civil aeronautical products within the framework of this Annex, when the design certificate holder and the production approval holder are not the same legal entity, the competent authorities of the Parties shall ensure that the design certificate holder establishes

proper arrangements with the production approval holder to ensure satisfactory coordination between design and production, and the proper support of the continued airworthiness of the civil aeronautical product.

#### *SECTION F: Export certificates*

##### Article 24: Forms

The exporting Party's forms are:

- (a) when the exporting Party is the United Kingdom, CAA Form 52 for new aircraft, export certificate of airworthiness for used aircraft, and CAA Form 1 for other new products; and
- (b) when the exporting Party is the Union, EASA Form 52 for new aircraft, export certificate of airworthiness for used aircraft, and EASA Form 1 for other new products.

##### Article 25: Issuance of an export certificate

1. When issuing an export certificate, the competent authority or production approval holder of the exporting Party shall ensure that such civil aeronautical product:

- (a) conforms to the design automatically accepted or validated, or certified by the importing Party in accordance with this Annex and as detailed in the technical implementation procedures;
- (b) is in a condition for safe operation;
- (c) meets all additional requirements notified by the importing Party; and
- (d) as regards civil aircraft, aircraft engines and aircraft propellers, complies with the applicable mandatory continuing airworthiness information, including airworthiness directives of the importing Party, as notified by that Party.

2. When issuing an export certificate of airworthiness for a used aircraft registered in the exporting Party, in addition to the requirements referred to in points (a) to (d) of paragraph 1, the competent authority of the exporting Party shall ensure that such aircraft has been properly maintained using approved procedures and methods of the exporting Party during its service life, as evidenced by logbooks and maintenance records.

##### Article 26: Acceptance of an export certificate for a new civil aeronautical product

The competent authority of the importing Party shall accept an export certificate issued by the competent authority or a production approval holder of the exporting Party for a civil aeronautical product, in accordance with the terms and conditions set out in this Annex and as detailed in the technical implementation procedures.

##### Article 27: Acceptance of an export certificate of airworthiness for a used aircraft

1. The competent authority of the importing Party shall accept an export certificate of airworthiness issued by the competent authority of the exporting Party for a used aircraft in accordance with the terms and conditions set out in this Annex and the technical implementation

procedures only if a holder of either a type certificate or a restricted type certificate exists for the used aircraft to support continued airworthiness of that type of aircraft.

2. For an export certificate of airworthiness for a used aircraft manufactured under the production oversight of the exporting Party to be accepted in accordance with paragraph 1, the competent authority of the exporting Party shall assist, upon request, the competent authority of the importing Party in obtaining data and information regarding:

- (a) the configuration of the aircraft at the time of dispatch from the manufacturer; and
- (b) subsequent changes and repairs applied to the aircraft that it has approved.

3. The importing Party may request inspection and maintenance records, as detailed in the technical implementation procedures.

4. If, in the process of assessing the airworthiness status of a used aircraft considered for export, the competent authority of the exporting Party is unable to satisfy all of the requirements set out in Article 25(2) [Issuance of an export certificate] and in paragraphs 1 and 2 of this Article, it shall:

- (a) notify the competent authority of the importing Party;
- (b) coordinate with the competent authority of the importing Party, as detailed in the technical implementation procedures, their acceptance or rejection of the exceptions to the applicable requirements; and
- (c) keep a record of any accepted exceptions when exporting.

#### *SECTION G: Qualification of competent authorities*

Article 28: Qualification requirements for the acceptance of findings of compliance and certificates

1. Each Party shall maintain a structured and effective certification and oversight system for the implementation of this Annex, including:

- (a) a legal and regulatory framework, ensuring in particular regulatory powers over entities regulated under the regulatory system for civil aviation safety of the Party;
- (b) an organisational structure, including a clear description of responsibilities;
- (c) sufficient resources, including qualified staff with sufficient knowledge, experience and training;
- (d) adequate processes documented in policies and procedures;
- (e) documentation and records; and
- (f) an established inspection programme ensuring a uniform level of implementation of the legal and regulatory framework among the various components of the oversight system.



## Article 29: Continued qualifications of the competent authorities

1. In order to maintain mutual confidence in each Party's regulatory system concerning the implementation of this Annex so that they ensure a sufficiently equivalent level of safety, the technical agent of each Party shall regularly assess the other Party's competent authorities' compliance with the qualification requirements referred to in Article 28 [Qualification requirements for the acceptance of findings of compliance and certificates]. The modalities of such continued mutual assessments shall be detailed in the technical implementation procedures.
2. The competent authority of a Party shall cooperate with the competent authority of the other Party whenever such assessments are required and ensure that regulated entities subject to its oversight provide access to the technical agents of the Parties.
3. If the technical agent of either Party believes that the technical competence of a competent authority of the other Party is no longer adequate, or that the acceptance of findings of compliance made or certificates issued by that competent authority should be suspended as the other Party's systems concerning the implementation of this Annex no longer ensure a sufficiently equivalent level of safety to permit such acceptance, the technical agents of the Parties shall consult in order to identify remedial actions.
4. If mutual confidence is not restored through mutually acceptable means, the technical agent of each Party may refer the matter referred to in paragraph 3 to the Certification Oversight Board.
5. If the matter is not resolved by the Certification Oversight Board, each Party may refer the matter referred to in paragraph 3 to the Specialised Committee on Aviation Safety.

## *SECTION H: Communications, consultations and support*

### Article 30: Communications

Subject to the exceptions decided by the technical agents of the Parties on a case-by-case basis, all communications between the competent authorities of the Parties, including documentation as detailed in the technical implementation procedures, shall be made in the English language.

### Article 31: Technical consultations

1. The technical agents of the Parties shall address issues concerning the implementation of this Annex through consultations.
2. If a mutually acceptable solution is not reached through consultations held pursuant to paragraph 1, the technical agent of each Party may refer an issue as referred to in paragraph 1 to the Certification Oversight Board.
3. If the issue is not resolved by the Certification Oversight Board, each Party may refer an issue as referred to in paragraph 1 to the Specialised Committee on Aviation Safety.

### Article 32: Support for certification and continued airworthiness oversight activities

Upon request, after mutual consent and as resources permit, the competent authority of a Party may provide technical support, data and information to the competent authority of the other Party in certification and continued airworthiness oversight activities related to design, production and



environmental protection certification. The support to be provided and the process for providing such support shall be detailed in the technical implementation procedures.

## ANNEX ROAD-1: TRANSPORT OF GOODS BY ROAD

- Part A – Requirements for road haulage operators in accordance with Article ROAD.5 of this Agreement

### *Section 1. Admission to, and the pursuit of, the occupation of road haulage operator*

#### Article 1 - Scope

This Section governs admission to, and the pursuit of, the occupation of road haulage operator and shall apply to all road haulage operators of a Party engaged in the transport of goods within the scope of Article ROAD.4 [Transport of goods between, through and within the territories of the Parties] of this Agreement.

#### Article 2 - Definitions

For the purposes of this Section,

- (a) "authorisation to pursue the occupation of road haulage operator" means an administrative decision which authorises a natural or legal person who fulfils the conditions laid down in this Section to pursue the occupation of road haulage operator;
- (b) "competent authority" means a national, regional or local authority in a Party which, for the purpose of authorising the pursuit of the occupation of road haulage operator, verifies whether a natural or legal person fulfils the conditions laid down in this Section, and which is empowered to grant, suspend or withdraw an authorisation to pursue the occupation of road haulage operator; and
- (c) "normal residence" means the place where a person usually lives, that is for at least 185 days in each calendar year, because of personal ties which show close links between that person and the place where that person is living.

#### Article 3 - Requirements for engagement in the occupation of road haulage operator

Natural or legal persons engaged in the occupation of road haulage operator shall:

- (a) have an effective and stable establishment in a Party as laid down in Article 5 of this Section;
- (b) be of good repute as laid down in Article 6 of this Section;
- (c) have appropriate financial standing as laid down in Article 7 of this Section; and
- (d) have the requisite professional competence as laid down in Article 8 of this Section.

#### Article 4 - Transport manager

1. A road haulage operator shall designate at least one natural person to be the transport manager, who effectively and continuously manages its transport activities and fulfils the requirements set out in points (b) and (d) of Article 3 and who:

- (a) has a genuine link to the road haulage operator, such as being an employee, director, owner or shareholder or administering it, or is that person; and
- (b) is resident in the Party in the territory of which the road haulage operator is established.

2. If a natural or legal person does not fulfil the requirement of professional competence, the competent authority may authorise the natural or legal person to engage in the occupation of road haulage operator without designating a transport manager in accordance with paragraph 1, provided that:

- (a) the natural or legal person designates a natural person residing in the Party of establishment of the road haulage operator who fulfils the requirements laid down in points (b) and (d) of Article 3 and who is entitled under contract to carry out duties as transport manager on behalf of the undertaking;
- (b) the contract linking the natural or legal person with the person referred to in point (a) specifies the tasks to be performed on an effective and continuous basis by that person and indicates that person's responsibilities as transport manager. The tasks to be specified shall comprise, in particular, those relating to vehicle maintenance management, verification of transport contracts and documents, basic accounting, the assignment of loads or services to drivers and vehicles, and the verification of safety procedures;
- (c) in his or her capacity as transport manager, the person referred to in point (a) may manage the transport activities of up to four different road haulage operators carried out with a combined maximum total fleet of 50 vehicles; and
- (d) the person referred to in point (a) performs the specified tasks solely in the interests of the natural or legal person and that person's responsibilities are exercised independently of any natural or legal persons for which it carries out transport operations.

3. A Party may decide that a transport manager designated in accordance with paragraph 1 may not in addition be designated in accordance with paragraph 2, or may only be so designated in respect of a limited number of natural or legal persons or a fleet of vehicles that is smaller than that referred to in point (c) of paragraph 2.

4. The natural or legal person shall notify the competent authority of the transport manager or managers designated.

#### Article 5 - Conditions relating to the requirement of establishment

In order to fulfil the requirement of effective and stable establishment in the Party of establishment, a natural or legal person shall:

- (a) have premises at which it is able to access the originals of its core business documents, whether in electronic or any other form in particular its transport contracts, documents relating to the vehicles at the disposal of the natural or legal person, accounting documents, personnel management documents, labour contracts, social security documents, documents containing data on the dispatching and posting of drivers, documents containing data relating to journeys, driving time and rest periods, and any other document to which the competent authority must have access in order to verify compliance with the conditions laid down in this Section;
- (b) be registered in the register of commercial companies of that Party or in a similar register whenever required under national law;

- (c) be subject to tax on revenues and, whenever required under national law, have assigned a VAT registration number;
- (d) once an authorisation has been granted, have at its disposal one or more vehicles which are registered or put into circulation and authorised to be used in conformity with the legislation of that Party, regardless of whether those vehicles are wholly owned or, for example, are held under a hire-purchase agreement or under a hire or leasing contract;
- (e) effectively and continuously conduct its administrative and commercial activities with the appropriate equipment and facilities at premises as referred to in point (a) situated in that Party and manage effectively and continuously its transport operations using the vehicles referred to in point (f) with the appropriate technical equipment situated in that Party; and
- (f) on an ongoing basis, have at its regular disposal a number of vehicles complying with the conditions laid down in point (d) and drivers normally based at an operational centre in that Party, proportionate to the volume of transport operations carried out by the undertaking.

#### Article 6 - Conditions relating to the requirement of good repute

1. Subject to paragraph 2, the Parties shall determine the conditions to be met by natural or legal persons and transport managers in order to fulfil the requirement of good repute.

In determining whether a natural or legal person has fulfilled that requirement, the Parties shall consider the conduct of the natural or legal person, its transport managers, executive directors and any other relevant person as may be determined by the Party. Any reference in this Article to convictions, penalties or infringements shall include convictions, penalties or infringements of the natural or legal person itself, its transport managers, executive directors and any other relevant person as may be determined by the Party.

The conditions referred to in the first part of this paragraph shall include at least the following:

- (a) that there be no compelling grounds for doubting the good repute of the transport manager or the road haulage operator, such as convictions or penalties for any serious infringement of national rules in force in the fields of:
  - (i) commercial law;
  - (ii) insolvency law;
  - (iii) pay and employment conditions in the profession;
  - (iv) road traffic;
  - (v) professional liability;
  - (vi) trafficking in human beings or drugs;
  - (vii) tax law; and
- (b) that the transport manager or the road haulage operator have not in one or both Parties been convicted of a serious criminal offence or incurred a penalty for a serious infringement of the rules of Title I of Heading Three of Part Two [Transport of goods by road] of this Agreement or of national rules relating in particular to:

- (i) the driving time and rest periods of drivers, working time and the installation and use of recording equipment;
- (ii) the maximum weights and dimensions of commercial vehicles used in international traffic;
- (iii) the initial qualification and continuous training of drivers;
- (iv) the roadworthiness of commercial vehicles, including the compulsory technical inspection of motor vehicles;
- (v) access to the market in international road haulage;
- (vi) safety in the carriage of dangerous goods by road;
- (vii) the installation and use of speed-limiting devices in certain categories of vehicle;
- (viii) driving licences;
- (ix) admission to the occupation;
- (x) animal transport;
- (xi) the posting of workers in road transport;
- (xii) the law applicable to contractual obligations; and
- (xiii) journeys whose points of loading and unloading are situated in the other Party.

2. For the purposes of point (b) of the third subparagraph of paragraph 1 of this Article, where the transport manager or the road haulage operator has been convicted of a serious criminal offence or has incurred a penalty for one of the most serious infringements as set out in Appendix ROAD.A.1.1 in one or both Parties, the competent authority in the Party of establishment shall carry out and complete in an appropriate and timely manner an administrative procedure, which shall include, if appropriate, an on-site inspection at the premises of the natural or legal person concerned.

During the administrative procedure, the competent authority shall assess whether, due to specific circumstances, the loss of good repute would constitute a disproportionate response in the individual case. In that assessment, the competent authority shall take into account the number of serious infringements of the rules as referred to in the third subparagraph of paragraph 1 of this Article, as well as the number of most serious infringements as set out in Appendix ROAD.A.1.1 for which the transport manager or the road haulage operator have been convicted or had penalties imposed on them. Any such finding shall be duly reasoned and justified.

Where the competent authority finds that the loss of good repute would be disproportionate, it shall decide that the natural or legal person concerned continues to be of good repute. Where the competent authority does not find that the loss of good repute would be disproportionate, the conviction or penalty shall lead to the loss of good repute.

3. The Specialised Committee on Road Transport shall draw up a list of categories, types and degrees of seriousness of serious infringements which, in addition to those set out in Appendix ROAD.A.1.1, may lead to the loss of good repute.

4. The requirement of good repute shall not be fulfilled until a rehabilitation measure or any other measure having an equivalent effect has been taken pursuant to the relevant provisions of national law of the Parties.

#### Article 7 - Conditions relating to the requirement of financial standing

1. In order to fulfil the requirement of financial standing, a natural or legal person shall, on a permanent basis, be able to meet its financial obligations in the course of the annual accounting year. The natural or legal person shall demonstrate, on the basis of annual accounts certified by an auditor or a duly accredited person, that, every year, it has at its disposal capital and reserves:

- (a) totalling at least EUR 9 000 / GBP 8 000 when only one motor vehicle is used, EUR 5 000 / GBP 4 500 for each additional motor vehicle or combination of vehicles used that has a permissible laden mass exceeding 3.5 tonnes and EUR 900 / GBP 800 for each additional motor vehicle or combination of vehicles that has a permissible laden mass, exceeding 2.5 tonnes but not 3.5 tonnes;
- (b) natural or legal persons engaged in the occupation of road haulage operator solely by means of motor vehicles or combinations of vehicles that have a permissible laden mass exceeding 2.5 tonnes but not 3.5 tonnes shall demonstrate, on the basis of annual accounts certified by an auditor or a duly accredited person, that, every year, they have at their disposal capital and reserves totalling at least EUR 1 800 / GBP 1 600 when only one vehicle is used and EUR 900 / GBP 800 for each additional vehicle used.

2. By way of derogation from paragraph 1, the competent authority may agree or require that an undertaking demonstrate its financial standing by means of a certificate determined by the competent authority, such as a bank guarantee or an insurance, including a professional liability insurance from one or more banks or other financial institutions including insurance companies or another binding document providing a joint and several guarantee for the undertaking in respect of the amounts specified in point (a) of paragraph 1.

3. By way of derogation from paragraph 1, in the absence of certified annual accounts for the year of an undertaking's registration, the competent authority shall agree that an undertaking is to demonstrate its financial standing by means of a certificate, such as a bank guarantee, a document issued by a financial institution establishing access to credit in the name of the undertaking, or another binding document as determined by the competent authority proving that the undertaking has at its disposal the amounts specified in point (a) of paragraph 1.

4. The annual accounts referred to in paragraph 1, and the guarantee referred to in paragraph 2, which are to be verified, are those of the economic entity established in the Party in which an authorisation has been applied for and not those of any other entity established in the other Party.

#### Article 8 - Conditions relating to the requirement of professional competence

1. In order to satisfy the requirement of professional competence, the person or persons concerned shall possess knowledge corresponding to the level provided for in Part I of Appendix ROAD.A.1.2 in the subjects listed therein. That knowledge shall be demonstrated by means of a compulsory written examination which, if a Party so decides, may be supplemented by an oral

examination. Those examinations shall be organised in accordance with Part II of Appendix ROAD.A.1.2. To this end, a Party may decide to impose training prior to the examination.

2. The persons concerned shall sit the examination in the Party in which they have their normal residence.

3. Only the authorities or bodies duly authorised for this purpose by a Party, in accordance with criteria defined by it, may organise and certify the written and oral examinations referred to in paragraph 1 of this Article. The Parties shall regularly verify that the conditions under which those authorities or bodies organise the examinations are in accordance with Appendix ROAD.A.1.2.

4. A Party may exempt the holders of certain higher education qualifications or technical education qualifications issued in that Party, specifically designated to this end and entailing knowledge of all the subjects listed in Appendix ROAD.A.1.2 from the examination in the subjects covered by those qualifications. The exemption shall only apply to those Sections of Part I of Appendix ROAD.A.1.2 for which the qualification covers all subjects listed under the heading of each Section.

A Party may exempt from specified parts of the examinations holders of certificates of professional competence valid for national transport operations in that Party.

#### Article 9 - Exemption from examination

For the purpose of granting a licence to a road haulage operator which only operates motor vehicles or combinations of vehicles the permissible laden mass of which does not exceed 3.5 tonnes, a Party may decide to exempt from the examinations referred to in Article 8(1) persons who provide proof that they have continuously managed, for the period of ten years before 20 August 2020, a natural or legal person of the same type.

#### Article 10 - Procedure for the suspension and withdrawal of authorisations

1. Where a competent authority establishes that a natural or legal person runs the risk of no longer fulfilling the requirements laid down in Article 3, it shall notify the natural or legal person thereof. Where a competent authority establishes that one or more of those requirements is no longer satisfied, it may set one of the following time limits for the natural or legal person to rectify the situation:

- (a) a time limit not exceeding 6 months, which may be extended by 3 months in the event of the death or physical incapacity of the transport manager, for the recruitment of a replacement transport manager where the transport manager no longer satisfies the requirement as to good repute or professional competence;
- (b) a time limit not exceeding 6 months where the natural or legal person has to rectify the situation by demonstrating that the natural or legal person has an effective and stable establishment; or
- (c) a time limit not exceeding 6 months where the requirement of financial standing is not satisfied, in order to demonstrate that that requirement is again satisfied on a permanent basis.

2. The competent authority may require a natural or legal person whose authorisation has been suspended or withdrawn to ensure that its transport managers have passed the examinations referred to in Article 8(1) prior to any rehabilitation measure being taken.

3. If the competent authority establishes that the natural or legal person no longer satisfies one or more of the requirements laid down in Article 3, it shall suspend or withdraw the authorisation to engage in the occupation of road haulage operator within the time limits referred to in paragraph 1 of this Article.

#### Article 11 - Declaration of unfitness of the transport manager

1. Where a transport manager loses good repute in accordance with Article 6, the competent authority shall declare that transport manager unfit to manage the transport activities of a road haulage operator.

The competent authority shall not rehabilitate the transport manager earlier than one year from the date of the loss of good repute and before the transport manager has demonstrated to have followed appropriate training for a period of at least 3 months or an exam on the subjects listed in Part I of Appendix ROAD.A.1.2.

2. Where a transport manager loses good repute in accordance with Article 6, an application for rehabilitation may be introduced after no less than one year from the date of the loss of good repute.

#### Article 12 - Examination and registration of applications

1. The competent authorities in each Party shall record in the national electronic registers referred to in Article 13(1) the data relating to undertakings which they authorise.

2. When assessing the good repute of an undertaking, the competent authorities shall verify, whether at the time of the application the designated transport manager or managers are declared, in one of the Parties, unfit to manage the transport activities of an undertaking pursuant to Article 11.

3. The competent authorities shall regularly monitor whether undertakings which they have authorised to engage in the occupation of road haulage operators continue to fulfil the requirements referred to in Article 3. To that end, the competent authorities shall carry out checks, including, where appropriate, on-site inspections at the premises of the undertaking concerned, targeting those undertakings which are classed as posing an increased risk.

#### Article 13 - National electronic registers

1. The competent authorities shall keep a national electronic register of road transport undertakings which have been authorised to engage in the occupation of road haulage operator.

2. The Specialised Committee on Road Transport shall establish the data contained in the national registers of road transport undertakings and the conditions of access to this data.



#### Article 14 - Administrative cooperation between the competent authorities

1. The competent authorities in each Party shall designate a national contact point responsible for the exchange of information with the competent authorities of the other Party with regard to the application of this Section.
2. The competent authorities in each Party shall cooperate closely and shall swiftly provide one another with mutual assistance and with any other relevant information in order to facilitate the implementation and enforcement of this Section.
3. The competent authorities in each Party shall carry out individual checks to verify whether an undertaking meets the conditions governing admission to the occupation of road haulage operator whenever a competent authority in the other Party so requests in duly justified cases. It shall inform the competent authority in the other Party of the results of such checks and of the measures taken if it is established that the undertaking no longer fulfils the requirements laid down in this Section.
4. The competent authorities in each Party shall exchange information on convictions and penalties for any serious infringements referred to in Article 6(2).
5. The Specialised Committee on Road Transport shall establish detailed rules on the modalities of the exchange of information referred to in paragraphs 3 and 4.

APPENDIX ROAD.A.1.1: Most serious infringements for the purpose of Article 6(2) of Section 1 of Part A of Annex ROAD.1

1. Exceeding time limits as follows:
  - (a) exceeding the maximum 6-day or fortnightly driving time limits by margins of 25 % or more;
  - (b) exceeding, during a daily working period, the maximum daily driving time limit by a margin of 50 % or more.
2. Not having a tachograph and/or speed limiter, or having in the vehicle and/or using a fraudulent device able to modify the records of the recording equipment and/or the speed limiter or falsifying record sheets or data downloaded from the tachograph and/or the driver card.
3. Driving without a valid roadworthiness certificate and/or driving with a very serious deficiency of, inter alia, the braking system, the steering linkages, the wheels/tyres, the suspension or chassis that would create such an immediate risk to road safety that it leads to a decision to immobilise the vehicle.
4. Transporting dangerous goods that are prohibited for transport or transporting such goods in a prohibited or non-approved means of containment or without identifying them on the vehicle as dangerous goods, thus endangering lives or the environment to such extent that it leads to a decision to immobilise the vehicle.
5. Carrying goods without holding a valid driving licence or carrying by an undertaking not holding a valid operator's licence as referred to in Article ROAD.5 of this Agreement.
6. Driving with a driver card that has been falsified, or with a card of which the driver is not the holder, or which has been obtained on the basis of false declarations and/or forged documents.
7. Carrying goods exceeding the maximum permissible laden mass by 20 % or more for vehicles the permissible laden weight of which exceeds 12 tonnes, and by 25 % or more for vehicles the permissible laden weight of which does not exceed 12 tonnes.

APPENDIX ROAD.A.1.2: Part I. LIST OF SUBJECTS REFERRED TO IN ARTICLE 8 of Section 1 of Part A of Annex ROAD.1

The knowledge to be taken into consideration for the official recognition of professional competence by the Parties must cover at least the subjects listed below. In relation to those subjects, applicant road haulage operators must have the levels of knowledge and practical aptitude necessary for the management of a transport undertaking.

The minimum level of knowledge, as indicated below, must correspond at least to the level of knowledge acquired during the course of compulsory education, which is supplemented either by vocational training and supplementary technical training or by secondary school or other technical training.

A. Civil law

The applicant must, in particular:

- (a) be familiar with the main types of contract used in road transport and with the rights and obligations arising therefrom;
- (b) be capable of negotiating a legally valid transport contract, notably with regard to conditions of carriage;
- (c) be able to consider a claim by the applicant's principal regarding compensation for loss of or damage to goods during transportation or for their late delivery, and to understand how such a claim affects the applicant's contractual liability; and
- (d) be familiar with the rules and obligations arising from the CMR Convention on the Contract for the International Carriage of Goods by Road done in Geneva on 19 May 1956.

B. Commercial law

The applicant must, in particular:

- (a) be familiar with the conditions and formalities laid down for plying the trade, the general obligations incumbent upon transport operators (registration, record keeping, etc.) and the consequences of bankruptcy; and
- (b) have appropriate knowledge of the various forms of commercial companies and the rules governing their constitution and operation.

C. Social law

The applicant must, in particular, be familiar with the following:

- (a) the role and function of the various social institutions which are concerned with road transport (trade unions, works councils, shop stewards, labour inspectors, etc.);
- (b) the employers' social security obligations;
- (c) the rules governing work contracts for the various categories of worker employed by road transport undertakings (form of the contracts, obligations of the parties, working conditions and working hours, paid leave, remuneration, breach of contract, etc.);

- (d) the rules applicable to driving time, rest periods and working time, and the practical measures for applying those provisions; and
- (e) the rules applicable to the initial qualification and continuous training of drivers laid down in Section 1 of part B of this Annex.

D. Fiscal law

The applicant must, in particular, be familiar with the rules governing:

- (a) value added tax (VAT) on transport services;
- (b) motor-vehicle tax;
- (c) the taxes on certain road haulage vehicles and tolls and infrastructure user charges; and
- (d) income tax.

E. Business and financial management

The applicant must, in particular:

- (a) be familiar with the laws and practices regarding the use of cheques, bills of exchange, promissory notes, credit cards and other means or methods of payment;
- (b) be familiar with the various forms of credit (bank credit, documentary credit, guarantee deposits, mortgages, leasing, renting, factoring, etc.) and the charges and obligations arising therefrom;
- (c) know what a balance sheet is, how it is set out and how to interpret it;
- (d) be able to read and interpret a profit and loss account;
- (e) be able to assess the undertaking's profitability and financial position, in particular on the basis of financial ratios;
- (f) be able to prepare a budget;
- (g) be familiar with the cost elements of the undertaking (fixed costs, variable costs, working capital, depreciation, etc.), and be able to calculate costs per vehicle, per kilometre, per journey or per tonne;
- (h) be able to draw up an organisation chart relating to the undertaking's personnel as a whole and to organise work plans, etc.;
- (i) be familiar with the principles of marketing, publicity and public relations, including transport services, sales promotion and the preparation of customer files, etc.;
- (j) be familiar with the different types of insurance relating to road transport (liability, accidental injury/life insurance, non-life and luggage insurance) and the guarantees and obligations arising therefrom;
- (k) be familiar with the applications of electronic data transmission in road transport;
- (l) be able to apply the rules governing the invoicing of road haulage services and know the meaning and implications of Incoterms; and

- (m) be familiar with the different categories of transport auxiliaries, their role, their functions and, where appropriate, their status.

F. Access to the market

The applicant must, in particular, be familiar with the following:

- (a) the occupational regulations governing road transport, industrial vehicle rental and subcontracting, and in particular the rules governing the official organisation of the occupation, admission to the occupation, authorisations for road transport operations, inspections and penalties;
- (b) the rules for setting up a road transport undertaking;
- (c) the various documents required for operating road transport services and the introduction of checking procedures to ensure that the approved documents relating to each transport operation, and in particular those relating to the vehicle, the driver, the goods and luggage are kept both in the vehicle and on the premises of the undertaking;
- (d) the rules on the organisation of the market in road haulage services, as well as the rules on freight handling and logistics; and
- (e) border formalities, the role and scope of T documents and TIR carnets, and the obligations and responsibilities arising from their use.

G. Technical standards and technical aspects of operation

The applicant must, in particular:

- (a) be familiar with the rules concerning the weights and dimensions of vehicles in the Parties and the procedures to be followed in the case of abnormal loads which constitute an exception to these rules;
- (b) be able to choose vehicles and their components (chassis, engine, transmission system, braking system, etc.) in accordance with the needs of the undertaking;
- (c) be familiar with the formalities relating to the type approval, registration and technical inspection of these vehicles;
- (d) understand what measures must be taken to reduce noise and to combat air pollution by motor vehicle exhaust emissions;
- (e) be able to draw up periodic maintenance plans for the vehicles and their equipment;
- (f) be familiar with the different types of cargo-handling and loading devices (tailboards, containers, pallets, etc.) and be able to introduce procedures and issue instructions for loading and unloading goods (load distribution, stacking, stowing, blocking and chocking, etc.);
- (g) be familiar with the various techniques of 'piggy-back' and roll-on roll-off combined transport;
- (h) be able to implement procedures to comply with the rules on the carriage of dangerous goods and waste;

- (i) be able to implement procedures to comply with the rules on the carriage of perishable foodstuffs, notably those arising from the Agreement on the International Carriage of Perishable Foodstuffs and on the Special Equipment to be used for such Carriage (ATP); and
- (j) be able to implement procedures to comply with the rules on the transport of live animals.

H. Road safety

The applicant must, in particular:

- (a) know what qualifications are required for drivers (driving licence, medical certificates, certificates of fitness, etc.);
- (b) be able to take the necessary steps to ensure that drivers comply with the traffic rules, prohibitions and restrictions in force in the Parties (speed limits, priorities, waiting and parking restrictions, use of lights, road signs, etc.);
- (c) be able to draw up instructions for drivers to check their compliance with the safety requirements concerning the condition of the vehicles, their equipment and cargo, and concerning preventive measures to be taken;
- (d) be able to lay down procedures to be followed in the event of an accident and to implement appropriate procedures to prevent the recurrence of accidents or serious traffic offences; and
- (e) be able to implement procedures to properly secure goods and be familiar with the corresponding techniques.

- Part II. ORGANISATION OF THE EXAMINATION

1. The Parties will organise a compulsory written examination which they may supplement by an optional oral examination to establish whether applicant road haulage operators have achieved the required level of knowledge in the subjects listed in Part I and in particular their capacity to use the instruments and techniques relating to those subjects and to fulfil the corresponding executive and coordination duties.

- (a) The compulsory written examination will involve two tests, namely:
  - (i) written questions consisting of either multiple choice questions (each with four possible answers), questions requiring direct answers or a combination of both systems; and
  - (ii) written exercises/case studies.

The minimum duration of each test will be two hours.

- (b) Where an oral examination is organised, the Parties may stipulate that participation is subject to the successful completion of the written examination.

2. Where the Parties also organise an oral examination, they must provide, in respect of each of the three tests, for a weighting of marks of a minimum of 25 % and a maximum of 40 % of the total number of marks to be given.

Where the Parties organise only a written examination, they must provide, in respect of each test, for a weighting of marks of a minimum of 40 % and a maximum of 60 % of the total number of marks to be given.

3. With regard to all the tests, applicants must obtain an average of at least 60 % of the total number of marks to be given, achieving in any given test not less than 50 % of the total number of marks possible. In one test only, a Party may reduce that mark from 50% to 40 %.

APPENDIX ROAD.A.1.3

- Part A
- Licence model for the Union

**EUROPEAN COMMUNITY**

(a)

(Colour Pantone light blue 290, or as close as possible to this colour, format DIN A4 cellulose paper  
100 g/m<sup>2</sup> or more)

(First page of the licence)

(Text in (one of) the official language(s) of the Member State issuing the licence)

Distinguishing sign of the Member State <sup>(1)</sup> issuing the licence
---

Name of the competent authority or body
---

LICENCE No ...

or

CERTIFIED TRUE COPY No ...

for the international carriage of goods by road for hire or reward

This licence entitles <sup>(2)</sup> .....

.....

.....

to engage in the international carriage of goods by road for hire or reward by any route, for journeys or parts of journeys carried out for hire or reward within the territory of the Community, as laid down in Regulation (EC) No 1072/2009 of the European Parliament and of the Council of 21 October 2009 (OJ EU L 300, 14.11.2009, p. 72) on common rules for access to the international road haulage market and in accordance with the general provisions of this licence.

Particular remarks: .....	
.....	
This licence is valid from .....	to .....
Issued in .....,	on .....
..... <sup>(3)</sup>	

<sup>(1)</sup> The distinguishing signs of the Member States are: (B) Belgium, (BG) Bulgaria, (CZ) Czech Republic, (DK) Denmark, (D) Germany, (EST) Estonia, (IRL) Ireland, (GR) Greece, (E) Spain, (F) France, (HR) Croatia, (I) Italy, (CY) Cyprus, (LV) Latvia, (LT) Lithuania, (L) Luxembourg, (H) Hungary, (MT) Malta, (NL) Netherlands, (A) Austria, (PL) Poland, (P) Portugal, (RO) Romania, (SLO) Slovenia, (SK) Slovakia, (FIN) Finland, (S) Sweden.

<sup>(2)</sup> Name or business name and full address of the haulier.

<sup>(3)</sup> Signature and seal of the issuing competent authority or body.



(b)

(Second page of the licence)

(Text in (one of) the official language(s) of the Member State issuing the licence)

## GENERAL PROVISIONS

This licence is issued under Regulation (EC) No 1072/2009.

It entitles the holder to engage in the international carriage of goods by road for hire or reward by any route for journeys or parts of journeys carried out within the territory of the Community and, where appropriate, subject to the conditions laid down herein:

- where the point of departure and the point of arrival are situated in two different Member States, with or without transit through one or more Member States or third countries,
- from a Member State to a third country or vice versa, with or without transit through one or more Member States or third countries,
- between third countries with transit through the territory of one or more Member States, and unladen journeys in connection with such carriage.

In the case of carriage from a Member State to a third country or vice versa, this licence is valid for that part of the journey carried out within the territory of the Community. It shall be valid in the Member State of loading or unloading only after the conclusion of the necessary agreement between the Community and the third country in question in accordance with Regulation (EC) No 1072/2009.

The licence is personal to the holder and is non-transferable.

It may be withdrawn by the competent authority of the Member State which issued it, notably where the holder has:

- not complied with all the conditions for using the licence,
- supplied incorrect information with regard to the data needed for the issue or extension of the licence.

The original of the licence must be kept by the haulage undertaking.

A certified copy of the licence must be kept in the vehicle <sup>(1)</sup>. In the case of a coupled combination of vehicles it must accompany the motor vehicle. It covers the coupled combination of vehicles even if the trailer or semi-trailer is not registered or authorised to use the roads in the name of the licence holder or if it is registered or authorised to use the roads in another State.

The licence must be presented at the request of any authorised inspecting officer.

Within the territory of each Member State, the holder must comply with the laws, regulations and administrative provisions in force in that State, in particular with regard to transport and traffic.

---

• <sup>(1)</sup> 'Vehicle' means a motor vehicle registered in a Member State, or a coupled combination of vehicles the motor vehicle of which at least is registered in a Member State, used exclusively for the carriage of goods.

- Part B
- Licence model for the United Kingdom

**UK Licence for the Community**

(a)

(Colour Pantone light blue, format DIN A4 cellulose paper 100 g/m2 or more)

(First page of the licence)

(Text in English or Welsh)



**NAME OF THE UK COMPETENT AUTHORITY**

<sup>(1)</sup>

LICENCE No:

Or

CERTIFIED TRUE COPY No:

for the international carriage of goods by road for hire or reward

This licence entitles<sup>(2)</sup>

---



---

to engage in the international carriage of goods by road for hire or reward by any route, for journeys or parts of journeys carried out for hire or reward within the territory of a Member State as laid down in Regulation (EC) 1072/2009<sup>(3)</sup>.

Particular remarks: .....	
.....	
This licence is valid from .....	to .....
Issued in .....	on .....

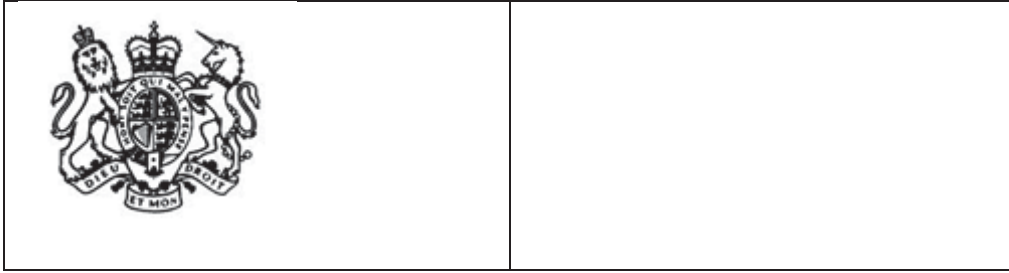

---

<sup>(1)</sup> Competent authority for the relevant region for which the certificate is issued.

<sup>(2)</sup> Name or business name and full address of the haulier.

<sup>(3)</sup> Regulation (EC) 1072/2009 as retained in UK law by section 3 of the European Union (Withdrawal) Act 2018 and as amended by regulations made under section 8 of that Act.

(b)

(Second page of the licence)

(Text in English or Welsh)

### GENERAL PROVISIONS

This licence is issued under Regulation (EC) No 1072/2009<sup>(1)</sup>.

It entitles the holder to engage in the international carriage of goods by road for hire or reward by any route for journeys or parts of journeys carried out within the territory of a Member State permitted by any international agreement between the United Kingdom and the European Union or a Member State.

In the case of carriage from the United Kingdom to a third country or vice versa, this licence is valid for that part of the journey carried out within the territory of any Member State.

The licence is personal to the holder and is non-transferable.

It may be withdrawn by a traffic commissioner or the Department for Infrastructure (Northern Ireland), for example, where the holder has:

- not complied with all the conditions for using the licence,
- supplied incorrect information with regard to the data needed for the issue or extension of the licence.

The original of the licence must be kept by the haulage undertaking.

A certified copy of the licence must be kept in the vehicle<sup>(2)</sup>. In the case of a coupled combination of vehicles it must accompany the motor vehicle. It covers the coupled combination of vehicles even if the trailer or semi-trailer is not registered or authorised to use the roads in the name of the licence holder or if it is registered or authorised to use the roads in another State.

The licence must be presented at the request of any authorised inspecting officer.

Within the territory of the United Kingdom or each Member State, the holder must comply with the laws, regulations and administrative provisions in force in that State, in particular with regard to transport and traffic.

<sup>(1)</sup> Regulation (EC) 1072/2009 as retained in UK law by section 3 of the European Union (Withdrawal) Act 2018 and as amended by regulations made under section 8 of that Act.

<sup>(2)</sup> 'Vehicle' means a motor vehicle registered in the United Kingdom or a Member State, or a coupled combination of motor vehicles the motor vehicle of which at least is registered in the United Kingdom or a Member State, used exclusively for the carriage of goods.

#### APPENDIX ROAD.A.1.4: Security features of the licence

The licence must have at least two of the following security features:

- a hologram;
- special fibres in the paper which become visible under UV-light;
- at least one microprint line (printing visible only with a magnifying glass and not reproduced by photocopying machines);
- tactile characters, symbols or patterns;
- double numbering: serial number of the licence, of the certified copy thereof as well as, in each case, the issue number;
- a security design background with fine guilloche patterns and rainbow printing.

## *Section 2. Posting of drivers*

### Article 1 - Subject matter

This Section lays down requirements for road haulage operators established in one of the Parties which, in the framework of the transport of goods, post drivers to the territory of the other Party in accordance with Article 3 of this Section.

Nothing in this Section shall prevent a Party from applying measures to regulate the entry of natural persons into, or their temporary stay in, its territory, including measures necessary to protect the integrity of its borders and to ensure the orderly movement of natural persons across them, provided that such measures are not applied in such a manner as to nullify or impair the benefits accruing to the other Party under the terms of this Section. The sole fact of requiring a visa for natural persons of certain countries and not for those of others shall not be regarded as nullifying or impairing benefits under this Section.

Nothing in this Section shall affect the application on the Union territory of the Union rules on the posting of drivers in road transport to Union road haulage operators.

### Article 2 - Definitions

For the purposes of this Section, "posted driver" means a driver who, for a limited period, carries out his or her work in the territory of a Party other than the Party in which the driver normally works.

### Article 3 - Principles

1. The provisions of this Section apply to the extent that the road haulage operator posts drivers to the territory of the other Party on its account and under its direction, under a contract concluded between the road haulage operator making the posting and the party for whom the transport services are intended, and those drivers operate in the territory of that Party, provided that there is an employment relationship between the road haulage operator making the posting and the driver during the period of posting.

2. For the purposes of paragraph 1, a posting shall be considered to start when the driver enters the territory of the other Party for the loading and/or unloading of goods and to end when the driver leaves the territory of that Party.

For the purposes of paragraph 1, in the case of posting in the Union, a posting shall, be considered to start when the driver enters the territory of a Member State for the loading and/or unloading of goods in that Member State and to end when the driver leaves the territory of that Member State.

3. Notwithstanding the paragraphs 1 and 2, a driver shall not be considered to be posted when performing transport operations, based on a transport contract, as defined in point (a) of Article ROAD.4(1) [Transport of goods between, through and within the territories of the Parties] of this Agreement.

4. A driver shall not be considered to be posted in the United Kingdom where the driver transits through the territory of the United Kingdom without loading or unloading of goods. For the Union, a driver shall not be considered to be posted in a Member State when the driver transits through the territory of that Member State without loading or unloading of goods.

### Article 4 - Terms and conditions of employment

1. Each Party shall ensure, irrespective of which law applies to the employment relationship, that road haulage operators guarantee, on the basis of equality of treatment, to drivers who are posted to their territory the terms and conditions of employment covering the following matters which, in the Party or, in the case of the Union, in the Member State where the work is carried out, are laid down:

— by law, regulation or administrative provision; and/or

— by collective agreements or arbitration awards which have been declared universally applicable or otherwise apply in accordance with paragraph 4:

- (a) maximum work periods and minimum rest periods;
- (b) minimum paid annual leave;
- (c) remuneration, including overtime rates; this point does not apply to supplementary occupational retirement pension schemes;
- (d) health, safety and hygiene at work;
- (e) protective measures with regard to the terms and conditions of employment of pregnant women or women who have recently given birth, of children and of young people; and
- (f) equality of treatment between men and women and other provisions on non-discrimination.

2. For the purposes of this Section, the concept of remuneration shall be determined by the national law and/or practice of the Party and, in the case of the Union, by the national law and/or practice of the Member State, to whose territory the driver is posted and means all the constituent elements of remuneration rendered mandatory by national law, regulation or administrative provision, or by collective agreements or arbitration awards which, in that Party or in that Member State, have been declared universally applicable or otherwise apply in accordance with paragraph 4.

3. Allowances specific to the posting shall be considered to be part of remuneration, unless they are paid in reimbursement of expenditure actually incurred on account of the posting, such as expenditure on travel, board and lodging. The road haulage operator shall reimburse the posted driver for such expenditure in accordance with the law and/or practice applicable to the employment relationship.

Where the terms and conditions of employment applicable to the employment relationship do not determine which elements of the allowance specific to the posting are paid in reimbursement of expenditure actually incurred on account of the posting or which are part of remuneration, then the entire allowance shall be considered to be paid in reimbursement of expenditure.

4. For the purpose of this Section, "collective agreements or arbitration awards which have been declared universally applicable" means collective agreements or arbitration awards which must be observed by all undertakings in the geographical area and in the profession or industry concerned.

In the absence of, or in addition to, a system for declaring collective agreements or arbitration awards to be of universal application within the meaning of the first part of this paragraph, each Party, or each Member State in the case of the Union, may, if they so decide, base themselves on:

- collective agreements or arbitration awards which are generally applicable to all similar undertakings in the geographical area and in the profession or industry concerned; and/or
- collective agreements which have been concluded by the most representative employers' and labour organisations at national level and which are applied throughout national territory.

Equality of treatment, within the meaning of paragraph 1, shall be deemed to exist where national undertakings in a similar position:

- (i) are subject, in the place in question or in the sector concerned, to the same obligations as posting undertakings as regards the matters listed in the first subparagraph of paragraph 1; and
- (ii) are required to fulfil such obligations with the same effects.

#### Article 5 - Improved access to information

1. Each Party or, in the case of the Union, each Member State shall publish the information on the terms and conditions of employment, in accordance with national law and/or practice, without undue delay and in a transparent manner, on a single official national website, including the constituent elements of remuneration as referred to in Article 4(2) and all the terms and conditions of employment in accordance with Article 4(1).

Each Party or, in the case of the Union, each Member State shall ensure that the information provided on the single official national website is accurate and up to date.

2. Each Party or, in the case of the Union, each Member State shall take the appropriate measures to ensure that the information mentioned in paragraph 1 is made generally available free of charge in a clear, transparent, comprehensive and easily accessible way at a distance and by electronic means, in formats and in accordance with web accessibility standards that ensure access to persons with disabilities and to ensure that competent national bodies are in a position to carry out their tasks effectively.

3. Where, in accordance with national law, traditions and practice, including respect for the autonomy of social partners, the terms and conditions of employment referred to in Article 4 are laid down in collective agreements in accordance with Article 4(1), each Party or, in the case of the Union, each Member State shall ensure that those terms and conditions are made available in an accessible and transparent way to service providers from the other Party and to posted drivers, and shall seek the involvement of the social partners in that respect. The relevant information should, in particular, cover the different minimum rates of pay and their constituent elements, the method used to calculate the remuneration due and, where relevant, the qualifying criteria for classification in the different wage categories.

4. Where, contrary to paragraph 1, the information on the single official national website does not indicate which terms and conditions of employment are to be applied, that circumstance shall be taken into account in accordance with national law and/or practice in determining penalties in the event of infringements to this Section, to the extent necessary to ensure the proportionality of those penalties.

5. Each Party or, in the case of the Union, each Member State shall indicate the bodies and authorities to which drivers and road haulage operators can turn for general information on national law and practice applicable to them concerning their rights and obligations within their territory.



## Article 6 - Administrative requirements, control and enforcement

1. Each Party or, in the case of the Union, each Member State may only impose the following administrative requirements and control measures with respect to the posting of drivers:

- (a) an obligation for the operator established in the other Party to submit a posting declaration to the national competent authorities of the Party or, in the case of the Union, of the Member State to which the driver is posted at the latest at the commencement of the posting, using from 2 February 2022 a multilingual standard form of the public interface connected to the EU Internal Market Information System<sup>136</sup> for administrative cooperation (IMI); that posting declaration shall consist of the following information:
  - (i) the identity of the operator, at least in the form of the number of the valid licence where this number is available;
  - (ii) the contact details of a transport manager or other contact person in the Party of establishment or, in the case of the Union, in the Member State of establishment to liaise with the competent authorities of the host Party or in, the case of the Union, of the Member State in which the services are provided and to send out and receive documents or notices;
  - (iii) the identity, the address of the residence and the number of the driving licence of the driver;
  - (iv) the start date of the driver's contract of employment, and the law applicable to it;
  - (v) the envisaged start and end date of the posting; and
  - (vi) the number plates of the motor vehicles;
- (b) an obligation for the operator to ensure that the driver has at his or her disposal in paper or electronic form and an obligation for the driver to keep and make available when requested at the roadside:
  - (i) a copy of the posting declaration submitted, via the IMI system from 2 February 2022;
  - (ii) evidence of the transport operations taking place in the host Party, such as an electronic consignment note (e-CMR); and
  - (iii) the tachograph records and in particular the country symbols of the Party or, in the case of the Union, of the Member State in which the driver was present when carrying out transport operations, in accordance with registration and record-keeping requirements under Section 2 of Part B and Section 4 of Part B;
- (c) an obligation for the operator to send, from 2 February 2022 via the public interface connected to the IMI system, after the period of posting, at the direct request of the competent authorities of the other Party or, in the case of the Union, of a Member State where the posting took place, copies of documents referred to in point (b) (ii) and (iii) of

---

<sup>136</sup> Established by Regulation (EU) 1024/2012.

this paragraph as well as documentation relating to the remuneration of the driver in respect of the period of posting, the employment contract or an equivalent document, time-sheets relating to the driver's work, and proof of payments.

The operator shall send the documentation, from 2 February 2022 via the public interface connected to the IMI system, no later than eight weeks from the date of the request. If the operator fails to submit the requested documentation within that time period, the competent authorities of the Party or, in the case of the Union, the Member State where the posting took place may request, from 2 February 2022 via the IMI system, the assistance of the competent authorities of the Party of establishment or, in the case of the Union, the Member State of establishment. When such a request for mutual assistance is made, the competent authorities of the Party of establishment or, in the case of the Union, the Member State of establishment of the operator shall have access to the posting declaration and other relevant information submitted by the operator, from 2 February 2022 via the public interface connected to the IMI system.

The competent authorities of the Party of establishment or, in the case of the Union, of the Member State of establishment shall ensure that they provide the requested documentation to the competent authorities of the Party or, in the case of the Union, to the competent authorities of the Member State where the posting took place, from 2 February 2022 via the IMI system, within 25 working days from the day of the request for mutual assistance.

Each Party shall ensure that the information exchanged by the competent national authorities or transmitted to them shall be used only in respect of the matter or matters for which it was requested.

Mutual administrative cooperation and assistance shall be provided free of charge.

A request for information shall not preclude the competent authorities from taking measures to investigate and prevent alleged breaches of this Section.

3. For the purpose of ascertaining whether a driver is not to be considered to be posted pursuant to Article 1, each Party may only impose as a control measure an obligation for the driver to keep and make available, where requested at the roadside check, in paper or electronic form, the evidence of the relevant transport operations, such as an electronic consignment note (e-CMR), and tachograph records, as referred to in point (b)(iii) of paragraph 2 of this Article.

4. For the purposes of control, the operator shall keep the posting declarations referred to in point (a) of paragraph 2 up to date, from 2 February 2022 in the public interface connected to IMI.

5. The information from the posting declarations shall be saved, from 2 February 2022, in the IMI repository for the purpose of checks for a period of 24 months.

6. The Party or, in the case of the Union, the Member State to whose territory the driver is posted and the Party or, in the case of the Union, the Member State from which the driver is posted shall be responsible for the monitoring, control and enforcement of the obligations laid down in this Section and shall take appropriate measures in the event of failure to comply with this Section.

7. Each Party or, in the case of the Union, the Member States shall ensure that inspections and controls of compliance under this Article are not discriminatory and/or disproportionate, whilst taking into account the relevant provisions of this Section.

8. For the enforcement of the obligations under this Section, each Party or, in the case of the Union, the Member States shall ensure that there are effective mechanisms for posted drivers to lodge complaints against their employers directly, as well as the right to institute judicial or administrative proceedings, also in the Party in whose territory the drivers are or were posted, where such drivers consider they have sustained loss or damage as a result of a failure to apply the applicable rules, even after the relationship in which the failure is alleged to have occurred has ended.

9. Paragraph 8 shall apply without prejudice to the jurisdiction of the courts of each Party or, in case of the Union, the Member States as laid down, in particular, in the relevant instruments of Union law and/or international conventions.

10. Each Party or, in the case of the Union, the Member States shall lay down the rules on penalties applicable to infringements of national provisions adopted pursuant to this Section and shall take all measures necessary to ensure that they are implemented and complied with. The penalties provided for shall be effective, proportionate and dissuasive.

Each Party shall notify those provisions to the other Party by 30 June 2021. They shall notify without delay any subsequent amendments to them.

#### Article 7 - Use of the IMI system

1. As from 2 February 2022, information, including personal data, referred to in Article 6 shall be exchanged and processed in the IMI system, provided that the following conditions are fulfilled:

- (a) the Parties provide safeguards that data processed in the IMI system are only used for the purpose for which they were initially exchanged;
- (b) any transfer of personal data to the United Kingdom under this Article may only take place in accordance with point (c) of Article 23(1) of Regulation (EU) [1024/2012](#)<sup>137</sup>; and
- (c) any transfer of personal data to the Union under this Article may only take place in accordance with the data protection rules on international transfers of the United Kingdom.

2. The competent authorities in each Party shall grant and revoke appropriate access rights to IMI users.

3. IMI users are allowed to access personal data processed in the IMI system only on a need-to-know basis and exclusively for the purpose of implementation and enforcement of this Section.

4. Each Party or, in the case of the Union, each Member State, may allow the competent authority to provide national social partners by other means than the IMI system with relevant information available in the IMI system to the extent necessary for the purpose of checking compliance with posting rules and in accordance with national law and practices, provided that:

---

<sup>137</sup> Regulation (EU) No [1024/2012](#) of the European Parliament and of the Council of 25 October 2012 on administrative cooperation through the Internal Market Information System and repealing Commission Decision 2008/49/EC ('the IMI Regulation') OJ L 316, 14.11.2012, p. 1

- (a) the information relates to a posting to the territory of the Party or, in the case of the Union, of the Member State, concerned; and
  - (b) the information is used exclusively for the purpose of enforcing the posting rules.
5. The Specialised Committee on Road Transport shall set the technical and procedural specifications of the use of the IMI system by the United Kingdom.
6. Each Party shall participate in the operating costs of the IMI system. The Specialised Committee on Road Transport shall determine the costs to be borne by each Party.

- PART B – Requirements for drivers involved in the transport of goods in accordance with Article ROAD.7 of this Agreement

*Section 1. Certificate of professional competence*

Article 1 - Scope

This Section applies to the activity of driving by anyone employed or used by a road haulage operator of a Party undertaking journeys referred to in Article ROAD.4 [Transport of goods between, through and within the territories of the Parties] of this Agreement and using vehicles for which a driving licence of category C1, C1+E, C or C+E, or a driving licence recognised as equivalent by the Specialised Committee on Road Transport, is required.

Article 2 - Exemptions

A certificate of professional competence (CPC) is not required for drivers of vehicles:

- (a) with a maximum authorised speed not exceeding 45 km/h;
- (b) used by, or under the control of, the armed forces, civil defence, the fire service, forces responsible for maintaining public order, and emergency ambulance services, when the carriage is undertaken as a consequence of the tasks assigned to those services;
- (c) undergoing road tests for technical development, repair or maintenance purposes, or the drivers of new or rebuilt vehicles which have not yet been put into service;
- (d) used in states of emergency or assigned to rescue missions;
- (e) carrying material, equipment or machinery to be used by the drivers in the course of their work, provided that driving the vehicles is not the drivers' principal activity; or
- (f) used, or hired without a driver, by agricultural, horticultural, forestry, farming or fishery undertakings for carrying goods as part of their own entrepreneurial activity, except if driving is part of the driver's principal activity or the driving exceeds a distance set in national law from the base of the undertaking which owns, hires or leases the vehicle.

Article 3 - Qualification and training

1. The activity of driving as defined in Article 1 shall be subject to a compulsory initial qualification and to compulsory periodic training. To that end the Parties shall provide for:

- (a) a system of initial qualification corresponding to one of the following two options:
  - (i) option combining both course attendance and a test

In accordance with Section 2(2.1) of Appendix ROAD.B.1.1, this type of initial qualification involves compulsory course attendance for a specific period. It shall conclude with a test. Upon successful completion of the test, the qualification shall be certified by a CPC as provided for in point (a) of Article 6(1);

- (ii) option involving only tests

In accordance with Section 2(2.2) of Appendix ROAD.B.1.1, this type of initial qualification does not involve compulsory course attendance but only theoretical and practical tests. Upon successful completion of the tests, the qualification shall be certified by a CPC as provided for in point (b) of Article 6(1).

However, a Party may authorise a driver to drive within its territory before obtaining a CPC, where the driver is undergoing a national vocational training course of at least six months, for a maximum period of three years. In the context of that vocational training course, the tests referred to in points (i) and (ii) of this point may be completed in stages;

(b) a system of periodic training

In accordance with Section 4 of Appendix ROAD.B.1.1, periodic training involves compulsory course attendance. It shall be certified by a CPC as provided for in Article 8(1).

2. A Party may also provide for a system of accelerated initial qualification so that a driver may drive in the cases referred to in points (a)(ii) and (b) of Article 5(2).

In accordance with Section 3 of Appendix ROAD.B.1.1, the accelerated initial qualification shall involve compulsory course attendance. It shall conclude with a test. Upon successful completion of the test, the qualification shall be certified by a CPC as provided for in Article 6(2).

3. A Party may exempt drivers who have obtained the certificate of professional competence provided for in Article 8 of Section 1 of Part A from the tests referred to in points (a)(i) and (ii) of paragraph 1 and in paragraph 2 of this Article in the subjects covered by the test provided for in that part of this Annex and, where appropriate, from attending the part of the course corresponding thereto.

#### Article 4 - Acquired rights

Drivers who hold a category C1, C1+E, C or C+E licence, or a licence recognised as equivalent by the Specialised Committee on Road Transport, issued no later than 10 September 2009, shall be exempted from the need to obtain an initial qualification.

#### Article 5 - Initial qualification

1. Access to an initial qualification shall not require the corresponding driving licence to be obtained beforehand.

2. Drivers of a vehicle intended for the carriage of goods may drive:

(a) from the age of 18:

(i) a vehicle in licence categories C and C+E, provided they hold a CPC as referred to in Article 6(1); and

(ii) a vehicle in licence categories C1 and C1+E, provided they hold a CPC as referred to in Article 6(2);

(b) from the age of 21, a vehicle in licence categories C and C+E, provided they hold a CPC as referred to in Article 6(2).

3. Without prejudice to the age limits specified in paragraph 2, drivers undertaking carriage of goods who hold a CPC as provided for in Article 6 for one of the categories provided for in paragraph

2 of this Article shall be exempted from obtaining such a CPC for any other of the categories of vehicles referred to in that paragraph.

4. Drivers undertaking carriage of goods who broaden or modify their activities in order to carry passengers, or vice versa, and who hold a CPC as provided for in Article 6, shall not be required to repeat the common parts of the initial qualification, but rather only the parts specific to the new qualification.

#### Article 6 - CPC certifying the initial qualification

##### 1. CPC certifying an initial qualification

###### (a) CPC awarded on the basis of course attendance and a test

In accordance with point (a)(i) of Article 3(1), the Parties shall require trainee drivers to attend courses in a training centre approved by the competent authorities in accordance with Section 5 of Appendix ROAD.B.1.1, hereinafter referred to as 'approved training centre'. Those courses shall cover all the subjects referred to in Section 1 of Appendix ROAD.B.1.1. That training shall conclude with successful completion of the test provided for in Section 2(2.1) of Appendix ROAD.B.1.1. That test shall be organised by the competent authorities in the Parties or an entity designated by them and shall serve to check whether, for the aforementioned subjects, the trainee driver has the level of knowledge required in Section 1 of Appendix ROAD.B.1.1. The said authorities or entities shall supervise the test and, upon successful completion, issue the drivers with a CPC certifying an initial qualification.

###### (b) CPC awarded on the basis of tests

In accordance with points (a)(ii) of Article 3(1), the Parties shall require trainee drivers to pass the theoretical and practical tests referred to in Section 2(2.2) of Appendix ROAD.B.1.1. Those tests shall be organised by the competent authorities in the Parties or an entity designated by them and shall serve to check whether, for all the aforementioned subjects, the trainee driver has the level of knowledge required in Section 1 of Appendix ROAD.B.1.1. The said authorities or entities shall supervise the tests and, upon successful completion, issue the drivers with a CPC certifying an initial qualification.

##### 2 CPC certifying an accelerated initial qualification

In accordance with Article 3(2), the Parties shall require trainee drivers to attend courses in an approved training centre. Those courses shall cover all the subjects referred to in Section 1 of Appendix ROAD.B.1.1.

That training shall conclude with the test provided for in Section 3 of Appendix ROAD.B.1.1. That test shall be organised by the competent authorities in the Parties or an entity designated by them and shall serve to check whether, for the aforementioned subjects, the trainee driver has the level of knowledge required in Section 1 of Appendix ROAD.B.1.1. The said authorities or entities shall supervise the test and, upon successful completion, issue the drivers with a CPC certifying an accelerated initial qualification.

## Article 7 - Periodic training

Periodic training shall consist of training to enable holders of a CPC to update the knowledge which is essential for their work, with specific emphasis on road safety, health and safety at work, and the reduction of the environmental impact of driving.

That training shall be organised by an approved training centre, in accordance with Section 5 of Appendix ROAD.B.1.1. Training shall consist of classroom teaching, practical training and, if available, training by means of information and communication technology (ICT) tools or on top-of-the-range simulators. If a driver moves to another undertaking, the periodic training already undergone must be taken into account.

Periodic training shall be designed to expand on, and to revise, some of the subjects referred in Section 1 of Appendix ROAD.B.1.1. It shall cover a variety of subjects and shall always include at least one road safety related subject. The training subjects shall take into account developments in the relevant legislation and technology, and shall, as far as possible, take into account the specific training needs of the driver.

## Article 8 - CPC certifying periodic training

1. When a driver has completed the periodic training referred to in Article 7, the competent authorities in the Parties or the approved training centre shall issue him or her with a CPC certifying periodic training.

2. The following drivers shall undergo a first course of periodic training:

(a) holders of a CPC as referred to in Article 6, within five years of the issue of that CPC; and

(b) the drivers referred to in Article 4, within five years of 10 September 2009.

A Party may reduce or exempt the periods of time referred to in point (a) or (b) by a maximum of two years.

3. A driver who has completed a first course of periodic training as referred to in paragraph 2 of this Article shall undergo periodic training every five years, before the end of the period of validity of the CPC certifying periodic training.

4. Holders of the CPC as referred to in Article 6 or the CPC as referred to in paragraph 1 of this Article and the drivers referred to in Article 4 who have ceased pursuit of the occupation and do not meet the requirements of paragraphs 1, 2 and 3, shall undergo a course of periodic training before resuming pursuit of the occupation.

5. Drivers undertaking the carriage of goods by road who have completed courses of periodic training for one of the licence categories provided for in Article 5(2) shall be exempt from the obligation to undergo further periodic training for another of the categories provided for in that paragraph.

## Article 9 - Enforcement

The competent authorities in a Party shall either affix directly on the driver's driving permit (licence), beside the corresponding categories of licence, a distinguishing sign attesting to the possession of a CPC and indicating the date of expiry, or introduce a special driver qualification card which should be drawn up in accordance with the model reproduced in Appendix ROAD.B.1.2. Any other model may



be acceptable provided that it is recognised as equivalent by the Specialised Committee on Road Transport. The driver qualification card or any equivalent document as specified above issued by the competent authorities in a Party shall be recognised by the other Party for the purposes of this Section.

Drivers must be able to present, at the request of any authorised inspecting officer, a driving permit (licence) or a specific driver qualification card or equivalent document bearing the distinguishing sign confirming possession of a CPC.

#### Appendix ROAD.B.1.1: MINIMUM QUALIFICATION AND TRAINING REQUIREMENTS

To ensure that the rules governing the transport of goods by road covered by Title I of Heading Three of Part Two [Transport of goods by road] are as harmonised as possible, the minimum requirements for driver qualification and training as well as the approval of training centres are set out in Sections 1 to 5 of this Appendix. Any other content for this qualification or training may be acceptable provided that it is considered as equivalent by the Specialised Committee on Road Transport.

##### *Section 1: List of subjects*

The knowledge to be taken into account by the Parties when establishing the driver's initial qualification and periodic training must include at least the subjects in this list. Trainee drivers must reach the level of knowledge and practical competence necessary to drive in all safety vehicles of the relevant licence category. The minimum level of knowledge may not be less than the level reached during compulsory education, supplemented by professional training.

#### 1. Advanced training in rational driving based on safety regulations

1.1 Objective: to know the characteristics of the transmission system in order to make the best possible use of it:

curves relating to torque, power, and specific consumption of an engine, area of optimum use of revolution counter, gearbox-ratio cover diagrams.

1.2 Objective: to know the technical characteristics and operation of the safety controls in order to control the vehicle, minimise wear and tear, and prevent disfunctioning:

limits to the use of brakes and retarder, combined use of brakes and retarder, making better use of speed and gear ratio, making use of vehicle inertia, using ways of slowing down and braking on downhill stretches, action in the event of failure, use of electronic and mechanical devices such as Electronic Stability Program (ESP), Advanced Emergency Braking Systems (AEBS), Anti-Lock Braking System (ABS), traction control systems (TCS) and in vehicle monitoring systems (IVMS) and other, approved for use, driver assistance or automation devices.

1.3 Objective: ability to optimise fuel consumption:

optimisation of fuel consumption by applying know-how as regards points 1.1 and 1.2, importance of anticipating traffic flow, appropriate distance to other vehicles and use of the vehicle's momentum, steady speed, smooth driving style and appropriate tyre pressure, and familiarity with intelligent transport systems that improve driving efficiency and assist in route planning.

1.4 Objective: ability to anticipate, assess and adapt to risks in traffic:

to be aware of and adapt to different road, traffic and weather conditions, anticipate forthcoming events; to understand how to prepare and plan a journey during abnormal weather conditions; to be familiar with the use of related safety equipment and to understand when a journey has to be postponed or cancelled due to extreme weather conditions; to adapt to the risks of traffic, including dangerous behaviour in traffic or distracted driving (through the use of electronic devices, eating, drinking, etc.); to recognise and adapt to dangerous situations and to be able to cope with stress deriving therefrom, in particular related to size and weight of the vehicles and vulnerable road users, such as pedestrians, cyclists and powered two wheelers;

to identify possible hazardous situations and properly interpret how those potentially hazardous situations may turn into situations where crashes can no longer be averted and selecting and implementing actions that increase the safety margins to such an extent that a crash can still be averted in case the potential hazards should occur.

1.5 Objective: ability to load the vehicle with due regard for safety rules and proper vehicle use:

forces affecting vehicles in motion, use of gearbox ratios according to vehicle load and road profile, use of automatic transmission systems, calculation of payload of vehicle or assembly, calculation of total volume, load distribution, consequences of overloading the axle, vehicle stability and centre of gravity, types of packaging and pallets;

main categories of goods needing securing, clamping and securing techniques, use of securing straps, checking of securing devices, use of handling equipment, placing and removal of tarpaulins.

2. Application of regulations

2.1 Objective: to know the social environment of road transport and the rules governing it:

maximum working periods specific to the transport industry; principles, application and consequences of the rules related to the driving times and rest periods and those related to the tachograph; penalties for failure to use, improper use of and tampering with the tachograph; knowledge of the social environment of road transport: rights and duties of drivers as regards initial qualification and periodic training.

2.2 Objective: to know the regulations governing the carriage of goods:

transport operating licences, documents to be carried in the vehicle, bans on using certain roads, road-use fees, obligations under standard contracts for the carriage of goods, drafting of documents which form the transport contract, international transport permits, obligations under the CMR Convention on the Contract for the International Carriage of Goods by Road<sup>138</sup>, drafting of the international consignment note, crossing borders, freight forwarders, special documents accompanying goods.

3. Health, road and environmental safety, service, logistics

3.1 Objective: to make drivers aware of the risks of the road and of accidents at work:

---

<sup>138</sup> Done in Geneva on 19 May 1956.

types of accidents at work in the transport sector, road accident statistics, involvement of lorries/coaches, human, material and financial consequences.

3.2 Objective: ability to prevent criminality and trafficking in illegal immigrants:

general information, implications for drivers, preventive measures, check list, legislation on transport operator liability.

3.3 Objective: ability to prevent physical risks:

ergonomic principles; movements and postures which pose a risk, physical fitness, handling exercises, personal protection.

3.4 Objective: awareness of the importance of physical and mental ability:

principles of healthy, balanced eating, effects of alcohol, drugs or any other substance likely to affect behaviour, symptoms, causes, effects of fatigue and stress, fundamental role of the basic work/rest cycle.

3.5 Objective: ability to assess emergency situations:

behaviour in an emergency situation: assessment of the situation, avoiding complications of an accident, summoning assistance, assisting casualties and giving first aid, reaction in the event of fire, evacuation of occupants of a lorry, reaction in the event of aggression; basic principles for the drafting of an accident report.

3.6 Objective: ability to adopt behaviour to help enhance the image of the company:

behaviour of the driver and company image: importance for the company of the standard of service provided by the driver, the roles of the driver, people with whom the driver will be dealing, vehicle maintenance, work organisation, commercial and financial effects of a dispute.

3.7 Objective: to know the economic environment of road haulage and the organisation of the market:

road transport in relation to other modes of transport (competition, shippers), different road transport activities (transport for hire or reward, own account, auxiliary transport activities), organisation of the main types of transport company and auxiliary transport activities, different transport specialisations (road tanker, controlled temperature, dangerous goods, animal transport, etc.), changes in the industry (diversification of services provided, rail-road, subcontracting, etc.).

*Section 2: Compulsory initial qualification provided for in point (a) of Article 3(1) of Section 1 of Part B*

A Party may count specific other training related to the transport of goods by road required under its legislation as part of the training under this Section and under Section 3 of this Appendix.

2.1. Option combining both course attendance and a test

Initial qualification must include the teaching of all subjects in the list under Section 1 of this Appendix. The duration of that initial qualification must be 280 hours.

Each trainee driver must drive for at least 20 hours individually in a vehicle of the category concerned which meets at least the requirements for test vehicles.

When driving individually, the trainee driver must be accompanied by an instructor, employed by an approved training centre. Each trainee driver may drive for a maximum of eight hours of the 20 hours of individual driving on special terrain or on a top-of-the-range simulator so as to assess training in rational driving based on safety regulations, in particular with regard to vehicle handling in different road conditions and the way they change with different atmospheric conditions, the time of day or night, and the ability to optimise fuel consumption.

A Party and, in the case of the Union, a Member State may allow part of the training to be delivered by the approved training centre by means of ICT tools, such as e-learning, while ensuring that the high quality and the effectiveness of the training are maintained, and by selecting the subjects where ICT tools can most effectively be deployed. Reliable user identification and appropriate means of control shall be required in such a case.

For the drivers referred to in Article 5(4) of Section 1 of Part B the length of the initial qualification must be 70 hours, including five hours of individual driving.

At the end of that training, the competent authorities in the Parties or the entity designated by them shall give the driver a written or oral test. The test must include at least one question on each of the objectives in the list of subjects under Section 1 of this Appendix.

## 2.2 Option involving a test

The competent authorities in the Parties or the entity designated by them shall organise the aforementioned theoretical and practical tests to check whether the trainee driver has the level of knowledge required in Section 1 of this Appendix for the subjects and objectives listed there.

- (a) The theoretical test shall consist of at least two parts:
- (i) questions including multiple-choice questions, questions requiring a direct answer, or a combination of both; and
  - (ii) case studies.

The minimum duration of the theoretical test must be four hours.

- (b) The practical test shall consist of two parts:
- (i) a driving test aimed at assessing training in rational driving based on safety regulations. The test must take place, whenever possible, on roads outside built-up areas, on fast roads and on motorways (or similar), and on all kinds of urban highways presenting the different types of difficulties that a driver is liable to encounter. It would be desirable for that test to take place in different traffic density conditions. The driving time on the road must be used optimally in order to assess the candidate in all traffic areas likely to be encountered. The minimum duration of that test must be 90 minutes;
  - (ii) a practical test covering at least points 1.5, 3.2, 3.3 and 3.5 of Section 1 of this Appendix.

The minimum duration of that test must be 30 minutes.

The vehicle used for the practical test must meet at least the requirements for test vehicles.

The practical test may be supplemented by a third test taking place on special terrain or on a top-of-the-range simulator so as to assess training in rational driving based on safety regulations, in particular with regard to vehicle handling in different road conditions and the way they change with different atmospheric conditions and the time of day or night.

The duration of that optional test is not fixed. Should the driver undergo such a test, its duration may be deducted from the 90 minutes of the driving test referred to under (i), but the time deducted may not exceed 30 minutes.

For the drivers referred to in Article 5(4) of Section 1 of Part B, the theoretical test must be limited to the subjects, referred to in Section 1 of this Appendix, which are relevant to the vehicles to which the new initial qualification applies. However, such drivers must undergo the whole practical test.

*Section 3: Accelerated initial qualification provided for in Article 3(2) of Section 1 of Part B of Annex ROAD.1*

Accelerated initial qualification must include the teaching of all subjects in the list in Section 1 of this Appendix. Its duration must be 140 hours.

Each trainee driver must drive for at least 10 hours individually in a vehicle of the category concerned which meets at least the requirements for test vehicles.

When driving individually, the trainee driver must be accompanied by an instructor, employed by an approved training centre. Each trainee driver may drive for a maximum of four hours of the 10 hours of individual driving on special terrain or on a top-of-the-range simulator so as to assess training in rational driving based on safety regulations, in particular with regard to vehicle handling in different road conditions and the way those road conditions change with different atmospheric conditions, the time of day or night, and the ability to optimise fuel consumption.

The provisions of the fourth paragraph of point 2.1 of Section 2 of this Appendix shall also apply to the accelerated initial qualification.

For the drivers referred to in Article 5(4) of Section 1 of Part B, the length of the accelerated initial qualification must be 35 hours, including two-and-a-half hours of individual driving.

At the end of that training, the competent authorities in the Parties or the entity designated by them shall give the driver a written or oral test. The test must include at least one question on each of the objectives in the list of subjects under Section 1 of this Appendix.

A Party may count specific other training related to the transport of goods by road required under its legislation as part of the training under this Section.

*Section 4: Compulsory periodic training provided for in point (b) of Article 3(1) of Section 1 of Part B of Annex ROAD.1*

Compulsory periodic training courses must be organised by an approved training centre. Their duration must be of 35 hours every five years, given in periods of at least seven hours, which may be split over two consecutive days. Whenever e-learning is used, the approved training centre shall ensure that the proper quality of the training is maintained, including by selecting the subjects where ICT tools can most effectively be deployed. In particular, the Parties shall require reliable user

identification and appropriate means of control. The maximum duration of the e-learning training shall not exceed 12 hours. At least one of the training course periods shall cover a road safety related subject. The content of the training shall take into account training needs specific to the transport operations carried out by the driver and relevant legal and technological developments and should, as far as possible, take into account specific training needs of the driver. A range of different subjects should be covered over the 35 hours, including repeat training where it is shown that the driver needs specific remedial training.

A Party and, in the case of the Union, a Member State may count specific other training related to the transport of goods by road required under its legislation as part of the training under this Section.

#### *Section 5: Approval of the initial qualification and periodic training*

5.1. The training centres taking part in the initial qualification and periodic training must be approved by the competent authorities in the Parties. Approval may be given only in response to a written application. The application must be accompanied by documents including:

5.1.1. a suitable qualification and training programme specifying the subjects taught and setting out the proposed implementing plan and teaching methods;

5.1.2. the instructors' qualifications and fields of activity;

5.1.3. information about the premises where the courses are given, the teaching materials, the resources made available for the practical work, and the vehicle fleet used;

5.1.4. the conditions regarding participation in the courses (number of participants).

5.2. The competent authority must give approval in writing subject to the following conditions:

5.2.1. the training must be given in accordance with the documents accompanying the application;

5.2.2. the competent authority must be entitled to send authorised persons to assist in the training courses of the approved centres, and must be entitled to monitor such centres, with regard to the resources used and the proper running of the training courses and tests;

5.2.3. the approval may be withdrawn or suspended if the conditions of approval are no longer complied with.

The approved centre must guarantee that the instructors have a sound knowledge of the most recent regulations and training requirements. As part of a specific selection procedure, the instructors must provide certification showing a knowledge of both the subject material and teaching methods. As regards the practical part of the training, instructors must provide certification of experience as professional drivers or similar driving experience, such as that of driving instructors for heavy vehicles.

The programme of instruction must be in accordance with the approval and must cover the subjects in the list in Section 1.

Appendix ROAD.B.1.2: Model of a driver qualification card referred to in Article 9 of Section 1 of Part B of this Annex

Side 1

**DRIVER QUALIFICATION CARD (MEMBER STATE/UK)**

6. PHOTO

1.  
2  
3  
4a.    4b.  
4c.    (4d.)  
5a.    5b.  
7  
(8.)

9.

Side 2

11.

9.	10.
C1	
C	
D1	
D	
C1E	
CE	
D1E	
DE	

1. Surname  
2. First name  
3. Date and place of birth  
4a. Date of issue  
4b. Administrative expiry date  
4c. Issued by  
5a. Licence No  
5b. Serial No  
10. Union code<sup>139</sup>

<sup>139</sup> If applicable

## *Section 2. Driving times, breaks and rest periods*

### Article 1 - Scope

1. This Section lays down the rules on driving time, breaks and rest periods for drivers referred to in point (b) of Article ROAD 7 (1) of this Agreement undertaking journeys referred to in Article ROAD.4 [Transport of goods between, through and within the territories of the Parties] of this Agreement.

2. Where a driver undertakes a journey referred to in Article ROAD.4 [Transport of goods between, through and within the territories of the Parties] of this Agreement, the rules in this Section apply to any road transport operation undertaken by that driver between the territories of the Parties and between Member States.

3. This Section applies:

- (a) where the maximum permissible mass of the vehicle, including any trailer, or semitrailer, exceeds 3.5 tonnes; or
- (b) from 1 July 2026, where the maximum permissible mass of the vehicle, including any trailer, or semi-trailer, exceeds 2.5 tonnes.

4. This Section does not apply to transport by:

- (a) vehicles or combinations of vehicles with a maximum permissible mass not exceeding 7.5 tonnes used for:
  - (i) carrying materials, equipment or machinery for the driver's use in the course of the driver's work, or
  - (ii) for delivering goods which are produced on a craft basis,

only within a 100 km radius from the base of the undertaking and on the condition that driving the vehicle does not constitute the driver's main activity and transport is not carried out for hire or reward;

- (b) vehicles with a maximum authorised speed not exceeding 40km/h;
- (c) vehicles owned or hired without a driver by the armed services, civil defence services, fire services, and forces responsible for maintaining public order when the transport is undertaken as a consequence of the tasks assigned to those services and is under their control;
- (d) vehicles used in emergencies or rescue operations;
- (e) specialised vehicles used for medical purposes;
- (f) specialised breakdown vehicles operating within a 100 km radius of their base;
- (g) vehicles undergoing road tests for technical development, repair or maintenance purposes, and new or rebuilt vehicles which have not yet been put into service;
- (h) vehicles with a maximum permissible mass, including any trailer, or semi-trailer exceeding 2.5 tonnes but not exceeding 3.5 tonnes that are used for the transport of goods, where



the transport is not effected for hire or reward, but on the own account of the company or the driver, and where driving does not constitute the main activity of the person driving the vehicle;

- (i) commercial vehicles, which have a historic status according to the legislation of the Member State in which they are being driven and which are used for the non-commercial transport of goods.

## Article 2 - Definitions

For the purposes of this Section, the following definitions apply:

- (a) "transport by road" means any journey made entirely or in part on roads open to the public by a vehicle, whether laden or not;
- (b) "break" means any period during which a driver may not carry out any driving or any other work and which is used exclusively for recuperation;
- (c) "other work" means all activities which are defined as working time in point (a) of Article 2(1) of Section 3 of Part B except 'driving', including any work for the same or another employer, within or outside of the transport sector;
- (d) "rest" means any uninterrupted period during which a driver may freely dispose of his or her time;
- (e) "daily rest period" means the daily period during which a driver may freely dispose of his or her time and covers a 'regular daily rest period' and a 'reduced daily rest period':
  - (i) "regular daily rest period" means any period of rest of at least 11 hours, which may be taken in two periods, the first of which must be an uninterrupted period of at least 3 hours and the second an uninterrupted period of at least nine hours; and
  - (ii) "reduced daily rest period" means any period of rest of at least nine hours but less than 11 hours;
- (f) "weekly rest period" means the weekly period during which a driver may freely dispose of his or her time and covers a 'regular weekly rest period' and a 'reduced weekly rest period':
  - (i) "regular weekly rest period" means any period of rest of at least 45 hours; and
  - (ii) "reduced weekly rest period" means any period of rest of less than 45 hours, which may, subject to the conditions laid down in Article 6(6) and 6(7) of this Section, be shortened to a minimum of 24 consecutive hours;
- (g) "a week" means the period of time between 00.00 on Monday and 24.00 on Sunday;
- (h) "driving time" means the duration of driving activity recorded:
  - (i) automatically or semi-automatically by the tachograph as defined in points (e), (f), (g) and (h) of Article 2 of Section 4 of Part B of this Annex; or
  - (ii) manually as required by Article 9(2) and 11 of Section 4 of Part B of this Annex;

- (i) "daily driving time" means the total accumulated driving time between the end of one daily rest period and the beginning of the following daily rest period or between a daily rest period and a weekly rest period;
- (j) "weekly driving time" means the total accumulated driving time during a week;
- (k) "maximum permissible mass" means the maximum authorised operating mass of a vehicle when fully laden;
- (l) "multi-manning" means the situation where, during each period of driving between any two consecutive daily rest periods, or between a daily rest period and a weekly rest period, there are at least two drivers in the vehicle to do the driving for the first hour of multimanning the presence of another driver or drivers is optional but for the remainder of the period it is compulsory;
- (m) "driving period" means the accumulated driving time from when a driver commences driving following a rest period or a break until the driver takes a rest period or a break; the driving period may be continuous or broken.

#### Article 3 - Requirement for drivers' mates

The minimum age for drivers' mates shall be 18 years. However, each Party and, in the case of the Union, a Member State may reduce the minimum age for drivers' mates to 16 years, provided that the reduction is for the purposes of vocational training and there is compliance with the limits imposed by the United Kingdom and, for the Union, the Member State's national rules on employment matters.

#### Article 4 - Driving times

1. The daily driving time shall not exceed nine hours.

However, the daily driving time may be extended to at most 10 hours not more than twice during the week.

2. The weekly driving time shall not exceed 56 hours and shall not result in the maximum weekly working time of 60 hours being exceeded.

3. The total accumulated driving time during any two consecutive weeks shall not exceed 90 hours.

4. Daily and weekly driving times shall include all driving time on the territory of the Parties.

5. A driver shall record as other work any time spent as described in point (c) of Article 2 of this Section as well as any time spent driving a vehicle used for commercial operations where a driver is not required to record driving time, and shall record any periods of availability, as defined in point (2) of Article 2 of Section 3 of Part B, in accordance with point (b)(iii) of Article 6(5) of Section 4 of Part B. This record shall be entered either manually on a record sheet or printout or by use of manual input facilities on recording equipment.

#### Article 5 - Breaks

After a driving period of four and a half hours a driver shall take an uninterrupted break of not less than 45 minutes, unless the driver takes a rest period.

That break may be replaced by a break of at least 15 minutes followed by a break of at least 30 minutes each distributed over the period in such a way as to comply with the provisions of the first paragraph.

A driver engaged in multi-manning may take a break of 45 minutes in a vehicle driven by another driver provided that the driver taking the break is not involved in assisting the driver driving the vehicle.

#### Article 6 - Rests

1. A driver shall take daily and weekly rest periods.
2. Within each period of 24 hours after the end of the previous daily rest period or weekly rest period a driver shall have taken a new daily rest period.

If the portion of the daily rest period which falls within that 24-hour period is at least nine hours but less than 11 hours, then the daily rest period in question shall be regarded as a reduced daily rest period.

3. A daily rest period may be extended to make a regular weekly rest period or a reduced weekly rest period.
4. A driver may have at most three reduced daily rest periods between any two weekly rest periods.
5. By way of derogation from paragraph 2, within 30 hours of the end of a daily or weekly rest period, a driver engaged in multi-manning must have taken a new daily rest period of at least nine hours.

6. In any two consecutive weeks a driver shall take at least:

- (a) two regular weekly rest periods; or
- (b) one regular weekly rest period and one reduced weekly rest period of at least 24 hours.

A weekly rest period shall start no later than at the end of six 24-hour periods from the end of the previous weekly rest period.

7. By way of derogation from paragraph 6, a driver engaged in international transport of goods may, outside the territory of the Party of the road haulage operator or, for drivers of EU road haulage operators, outside the territory of the Member State of the road haulage operator, take two consecutive reduced weekly rest periods provided that the driver in any four consecutive weeks takes at least four weekly rest periods, of which at least two shall be regular weekly rest periods.

For the purpose of this paragraph, a driver shall be considered to be engaged in international transport where the driver starts the two consecutive reduced weekly rest periods outside the territory of the Party of the road haulage operator and drivers' place of residence or, for the Union, outside the territory of the Member State of the road haulage operator and the country of the drivers' place of residence.

Any reduction in weekly rest period shall be compensated by an equivalent period of rest taken *en bloc* before the end of the third week following the week in question.

Where two reduced weekly rest periods have been taken consecutively in accordance with the third subparagraph, the next weekly rest period shall be preceded by a rest period taken as compensation for those two reduced weekly rest periods.

8. Any rest taken as compensation for a reduced weekly rest period shall be attached to another rest period of at least nine hours.

9. The regular weekly rest periods and any weekly rest period of more than 45 hours taken in compensation for previous reduced weekly rest periods shall not be taken in a vehicle. They shall be taken in suitable gender-friendly accommodation with adequate sleeping and sanitary facilities.

Any costs for accommodation outside the vehicle shall be covered by the employer.

10. Transport undertakings shall organise the work of drivers in such a way that the drivers are able to return to the employer's operational centre where the driver is normally based and where the driver's weekly rest period begins, in the United Kingdom and, in the case of the Union, the Member State of the employer's establishment, or to return to the drivers' place of residence, within each period of four consecutive weeks, in order to spend at least one regular weekly rest period or a weekly rest period of more than 45 hours taken in compensation for reduced weekly rest period.

However, where the driver has taken two consecutive reduced weekly rest periods in accordance with paragraph 7, the transport undertaking shall organise the work of the driver in such a way that the driver is able to return before the start of the regular weekly rest period of more than 45 hours taken in compensation.

The undertaking shall document how it fulfils that obligation and shall keep the documentation at its premises in order to present it at the request of control authorities.

11. A weekly rest period that falls in two weeks may be counted in either week, but not in both.

12. By way of derogation, where a driver accompanies a vehicle which is transported by ferry or train and takes a regular daily rest period or a reduced weekly rest period, that period may be interrupted not more than twice by other activities not exceeding one hour in total. During that regular daily rest or reduced weekly rest period the driver shall have access to a sleeper cabin, bunk or couchette at their disposal.

With regard to regular weekly rest periods, that derogation shall only apply to ferry or train journeys where:

- (a) the journey is scheduled for 8 hours or more; and
- (b) the driver has access to a sleeper cabin in the ferry or on the train.

13. Any time spent travelling to a location to take charge of a vehicle falling within the scope of this Section, or to return from that location, when the vehicle is neither at the driver's home nor at the employer's operational centre where the driver is normally based, shall not be counted as a rest or break unless the driver is on a ferry or train and has access to a sleeper cabin, bunk or couchette.

14. Any time spent by a driver driving a vehicle which falls outside the scope of this Section to or from a vehicle which falls within the scope of this Section, which is not at the driver's home or at the employer's operational centre where the driver is normally based, shall count as other work.

## Article 7 - Liability of road haulage operators

1. A road haulage operator of a Party shall not give drivers it employs or who are put at its disposal any payment, even in the form of a bonus or wage supplement, related to distances travelled, the speed of delivery and/or the amount of goods carried if that payment is of such a kind as to endanger road safety and/or encourages infringement of this Section.

2. A road haulage operator of a Party shall organise road transport operations and properly instruct crew members so that they are able to comply with the provisions of this Section.

3. A road haulage operator of a Party shall be liable for infringements committed by drivers of the operator, even if the infringement was committed on the territory of the other Party.

Without prejudice to the right of the Parties to hold road haulage operators fully liable, the Parties may make this liability conditional on the operator's infringement of paragraphs 1 and 2. The Parties may consider any evidence that the road haulage operator cannot reasonably be held responsible for the infringement committed.

4. Road haulage operators, consignors, freight forwarders, principal contractors, subcontractors and driver employment agencies shall ensure that contractually agreed transport time schedules respect this Section.

5. A road haulage operator which uses vehicles that are fitted with recording equipment complying with points (f), (g) or (h) of Article 2 of Section 4 of Part B and that fall within the scope of this Section, shall:

- (i) ensure that all data are downloaded from the vehicle unit and driver card as regularly as is stipulated by the Party and that relevant data are downloaded more frequently so as to ensure that all data concerning activities undertaken by or for that road haulage operator are downloaded; and
- (ii) ensure that all data downloaded from both the vehicle unit and driver card are kept for at least 12 months following recording and, should an inspecting officer request it, such data are accessible, either directly or remotely, from the premises of the road haulage operator.

For the purposes of this paragraph "downloaded" shall be interpreted in accordance with the definition laid down in point (h) of Article 2(2) of Section 2 of Part C.

The maximum period within which the relevant data shall be downloaded under point (i) of this paragraph shall be 90 days for data from the vehicle unit and 28 days for data from the driver card.

## Article 8 - Exceptions

1. Provided that road safety is not thereby jeopardised and to enable the vehicle to reach a suitable stopping place, the driver may depart from Articles 4 to 6 to the extent necessary to ensure the safety of persons, of the vehicle or its load. The driver shall indicate the reason for such departure manually on the record sheet of the recording equipment or on a printout from the recording equipment or in the duty roster, at the latest on arrival at the suitable stopping place.

2. Provided that road safety is not thereby jeopardised, in exceptional circumstances, the driver may also depart from Article 4(1) and (2) and from Article 6(2) by exceeding the daily and

weekly driving time by up to one hour in order to reach the employer's operational centre or the driver's place of residence to take a weekly rest period.

Under the same conditions, the driver may exceed the daily and weekly driving time by up to two hours, provided that an uninterrupted break of 30 minutes was taken immediately prior to the additional driving in order to reach the employer's operational centre or the driver's place of residence for taking a regular weekly rest period.

The driver shall indicate the reason for such departure manually on the record sheet of the recording equipment, or on a printout from the recording equipment or in the duty roster, at the latest on arrival at the destination or the suitable stopping place.

Any period of extension shall be compensated by an equivalent period of rest taken *en bloc* with any rest period, by the end of the third week following the week in question.

3. Provided that road safety is not thereby jeopardised, each Party and, in the case of the Union, a Member State may grant exceptions from Articles 3 to 6 and make such exceptions subject to individual conditions on its own territory or, with the agreement of the other Party, on the territory of the other Party, applicable to transport by the following:

- (a) vehicles owned or hired, without a driver, by public authorities to undertake transport by road which do not compete with private road haulage operators;
- (b) vehicles used or hired, without a driver, by agricultural, horticultural, forestry, farming or fishery undertakings for carrying goods as part of their own entrepreneurial activity within a radius of up to 100 km from the base of the undertaking;
- (c) agricultural tractors and forestry tractors used for agricultural or forestry activities, within a radius of up to 100 km from the base of the undertaking which owns, hires or leases the vehicle;
- (d) vehicles or combinations of vehicles with a maximum permissible mass not exceeding 7,5 tonnes used by universal service providers to deliver items as part of the universal service. Those vehicles shall be used only within a 100 km radius from the base of the undertaking, and on condition that driving the vehicles does not constitute the driver's main activity;
- (e) vehicles operating exclusively on islands not exceeding 2 300 square kilometres in area which are not linked to the rest of the national territory by a bridge, ford or tunnel open for use by motor vehicles;
- (f) vehicles used for the transport of goods within a 100 km radius from the base of the undertaking and propelled by means of natural or liquefied gas or electricity, the maximum permissible mass of which, including the mass of a trailer or semi-trailer, does not exceed 7,5 tonnes;
- (g) vehicles used in connection with sewerage, flood protection, water, gas and electricity maintenance services, road maintenance and control, door-to-door household refuse collection and disposal, telegraph and telephone services, radio and television broadcasting, and the detection of radio or television transmitters or receivers;
- (h) specialised vehicles transporting circus and funfair equipment;

- (i) specially fitted mobile project vehicles, the primary purpose of which is use as an educational facility when stationary;
- (j) vehicles used for milk collection from farms and/or for the return to farms of milk containers or milk products intended for animal feed;
- (k) specialised vehicles transporting money and/or valuables;
- (l) vehicles used for carrying animal waste or carcasses which are not intended for human consumption;
- (m) vehicles used exclusively on roads inside hub facilities such as ports, interports and railway terminals;
- (n) vehicles used for the transport of live animals from farms to local markets and vice versa or from markets to local slaughterhouses within a radius of up to 100 km;
- (o) vehicles or combinations of vehicles carrying construction machinery for a construction undertaking, up to a radius of 100 km from the base of the undertaking, provided that driving the vehicles does not constitute the driver's main activity; and
- (p) vehicles used for the delivery of ready-mixed concrete.

4. Provided that working conditions of drivers and road safety are not thereby jeopardised and that the limits set out in Article 3 of Section 3 of Part B are complied with, a Party, and in the case of the Union, a Member State, may grant temporary exceptions from the application of Articles 4 to 6 of this Section to transport operations carried out in exceptional circumstances, in accordance with the procedure applicable in the Party.

The temporary exceptions shall be duly reasoned and notified immediately to the other Party. The Specialised Committee on Road Transport shall specify the modalities of that notification. Each Party shall immediately publish that information on a public website and shall ensure that its enforcement activities to take into account an exception granted by the other Party.

### *Section 3. Working time of mobile workers*

#### Article 1 - Scope

1. This Section applies to mobile workers employed by road haulage operators of the Parties, undertaking journeys referred to in Article ROAD.4 [Transport of goods between, through and within the territories of the Parties] of this Agreement.

This Section shall also apply to self-employed drivers.

2. In so far as this Section contains more specific provisions as regards mobile workers performing road transport activities it shall take precedence over the relevant provisions of Article LPF.2.27.

3. This Section shall supplement the provisions of Section 2 of Part B which take precedence over the provisions of this Section.

4. A Party may disapply the application of this Section for mobile workers and self-employed drivers undertaking no more than two return journeys in accordance with Article ROAD.4 [Transport of goods between, through and within the territories of the Parties] of this Agreement in a calendar month.

5. Where a Party disapplies the application of this Section under Paragraph 4, that Party shall notify the other Party.

#### Article 2 - Definitions

For the purposes of this Section, the following definitions apply:

(1) "working time" means:

(a) in the case of mobile workers: the time from the beginning to the end of work, during which the mobile worker is at his or her workstation, at the disposal of the employer and exercising his or her functions or activities, that is to say:

the time devoted to all road transport activities, in particular, the following:

- (i) driving;
- (ii) loading and unloading;
- (iii) assisting passengers boarding and disembarking from the vehicle;
- (iv) cleaning and technical maintenance; and
- (v) all other work intended to ensure the safety of the vehicle and its cargo or to fulfil the legal or regulatory obligations directly linked to the specific transport operation under way, including monitoring of loading and unloading, administrative formalities with police, customs, immigration officers etc.,

- the times during which driver cannot dispose freely of his or her time and is required to be at his or her workstation, ready to take up normal work, with certain tasks associated with being on duty, in particular during periods awaiting loading or unloading where their



foreseeable duration is not known in advance, that is to say either before departure or just before the actual start of the period in question, or under the general conditions negotiated between the social partners and/or under the terms of the legislation of the Parties;

- (b) in the case of self-employed drivers, the same definition applies to the time from the beginning to the end of work, during which the self-employed driver is at his or her workstation, at the disposal of the client and exercising his or her functions or activities other than general administrative work that is not directly linked to the specific transport operation under way.

The break times referred to in Article 4, the rest times referred to in Article 5 and, without prejudice to the legislation of the Parties or agreements between the social partners providing that such periods should be compensated or limited, the periods of availability referred to in point (2) of this Article, shall be excluded from working time;

(2) "periods of availability" means:

- periods other than those relating to break times and rest times during which the mobile worker is not required to remain at his or her workstation, but must be available to answer any calls to start or resume driving or to carry out other work. In particular such periods of availability shall include periods during which the mobile worker is accompanying a vehicle being transported by ferryboat or by train as well as periods of waiting at frontiers and those due to traffic prohibitions.

- Those periods and their foreseeable duration shall be known in advance by the mobile worker, that is to say either before departure or just before the actual start of the period in question, or under the general conditions negotiated between the social partners and/or under the terms of the legislation of the Parties,

- for mobile workers driving in a team, the time spent sitting next to the driver or on the couchette while the vehicle is in motion;

(3) "workstation" means:

- the location of the main place of business of the road haulage operator for which the person performing mobile road transport activities carries out duties, together with its various subsidiary places of business, regardless of whether they are located in the same place as its head office or main place of business;

- the vehicle which the person performing mobile road transport activities uses when that person carries out duties; and

- any other place in which activities connected with transportation are carried out;

(4) "mobile worker" means, for the purpose of this Section, any worker forming part of the travelling staff, including trainees and apprentices, who is in the service of an undertaking which operates transport services for passengers or goods by road on the territory of the other Party;

(5) "self-employed driver" means anyone whose main occupation is to transport of goods by road for hire or reward, who is entitled to work for himself and who is not tied to an employer by an employment contract or by any other type of working hierarchical relationship, who is free to organise the relevant working activities, whose income depends directly on the profits made and

who has the freedom to, individually or through a cooperation between self-employed drivers, have commercial relations with several customers.

For the purposes of this Section, those drivers who do not satisfy those criteria shall be subject to the same obligations and benefit from the same rights as those provided for mobile workers by this Section;

(6) "person performing mobile road transport activities" means any mobile worker or self-employed driver who performs such activities;

(7) "week" means the period between 00.00 hours on Monday and 24.00 hours on Sunday;

(8) "night time" means a period of at least four hours, as defined by national law, between 00.00 hours and 07.00 hours; and

(9) "night work" means any work performed during night time.

#### Article 3 - Maximum weekly working time

1. Each Party shall take the measures necessary to ensure that the average weekly working time may not exceed 48 hours. The maximum weekly working time may be extended to 60 hours only if, over four months, an average of 48 hours a week is not exceeded.

2. Each Party shall take the measures necessary to ensure that working time for different employers is the sum of the working hours. The employer shall ask the mobile worker concerned in writing for an account of time worked for another employer. The mobile worker shall provide such information in writing.

#### Article 4 - Breaks

Each Party shall take the measures necessary to ensure that, without prejudice to the provisions of Section 2 of Part B of this Annex, persons performing mobile road transport activities, in no circumstances work for more than six consecutive hours without a break. Working time shall be interrupted by a break of at least 30 minutes, if working hours total between six and nine hours, and of at least 45 minutes, if working hours total more than nine hours.

Breaks may be subdivided into periods of at least 15 minutes each.

#### Article 5 - Rest periods

For the purposes of this Section, apprentices and trainees who are in the service of an undertaking which operates transport services for passengers or goods by road journeys on the territory of the other Party shall be covered by the same provisions on rest time as other mobile workers pursuant to Section 2 of Part B of this Annex.

#### Article 6 - Night work

Each Party shall take the measures necessary to ensure that:

(a) if night work is performed, the daily working time does not exceed ten hours in each 24 period; and

- (b) compensation for night work is given in accordance with national legislative measures, collective agreements, agreements between the two sides of industry and/or national practice, on condition that such compensation is not liable to endanger road safety.

#### Article 7 - Derogations

1. Derogations from Articles 3 and 6 may, for objective or technical reasons or reasons concerning the organisation of work, be adopted by means of collective agreements, agreements between the social partners, or if that is not possible, by laws, regulations or administrative provisions provided that there is consultation of the representatives of the employers and workers concerned and efforts are made to encourage all relevant forms of social dialogue.
2. The option to derogate from Article 3 may not result in the establishment of a reference period exceeding six months, for calculation of the average maximum weekly working time of forty-eight hours.
3. The Specialised Committee on Road Transport shall be informed of the derogations applied by a Party according to paragraph 1.

#### Article 8 - Information and records

Each Party shall ensure that:

- (a) mobile workers are informed of the relevant national requirements, the internal rules of the road haulage operator and agreements between the two sides of industry, in particular collective agreements and any company agreements, reached on the basis of this Section; and
- (b) the working time of persons performing mobile road transport activities is recorded. Records shall be kept for at least two years after the end of the period covered. Employers shall be responsible for recording the working time of mobile workers. Employers shall upon request provide mobile workers with copies of the records of hours worked.

#### Article 9 - More favourable provisions

This Section shall not affect the right of each Party to apply or introduce laws, regulations or administrative provisions more favourable to the protection of the health and safety of persons performing mobile road transport activities, or their right to facilitate or permit the application of collective agreements or other agreements concluded between the two sides of industry which are more favourable to the protection of the health and safety of mobile workers. Those rules shall be applied in a non-discriminatory manner.

#### *Section 4. Use of tachographs by drivers*

##### Article 1 - Subject matter and principles

This Section lays down requirements for drivers falling within the scope of Section 2 of Part B regarding the use of tachographs referred to in point (b) of Article ROAD.7(1) of this Agreement.

##### Article 2 - Definitions

For the purposes of this Section, the definitions set out in Article 2 of Section 2 of Part B apply.

In addition to the definitions referred to in paragraph 1, for the purposes of this Section the following definitions apply:

- (a) "tachograph" or "recording equipment" means the equipment intended for installation in road vehicles to display, record, print, store and output automatically or semi-automatically details of the movement, including the speed, of such vehicles and details of certain periods of activity of their drivers;
- (b) "record sheet" means a sheet designed to accept and retain recorded data, to be placed in an analogue tachograph, and on which the marking devices of the analogue tachograph continuously inscribe the information to be recorded;
- (c) "tachograph card" means a smart card, intended for use with the tachograph, which allows identification by the tachograph of the role of the cardholder and allows data transfer and storage;
- (d) "driver card" means a tachograph card, issued by the competent authorities in a Party to a particular driver, which identifies the driver and allows for the storage of driver activity data;
- (e) "analogue tachograph" means a tachograph complying with the specifications in annex I to Council Regulation (EEC) No 3821/85<sup>140</sup>, as adapted by Appendix ROAD.B.4.1;
- (f) "digital tachograph" means a tachograph complying with one of the following set of specifications, as adapted by Appendix ROAD.B.4.2:
  - Annex IB to Council Regulation (EEC) No 3821/85 applicable until 30 September 2011;
  - Annex IB to Council Regulation (EEC) No 3821/85 applicable from 1 October 2011; or
  - Annex IB to Council Regulation (EEC) No 3821/85 applicable from 1 October 2012;
- (g) "smart tachograph 1" means a tachograph complying with annex IC to Commission implementing regulation (EU) 2016/799 applicable from 15 June 2019, as adapted by Appendix ROAD.B.4.3;

---

<sup>140</sup> Council Regulation (EEC) No 3821/85 of 20 December 1985 on recording equipment in road transport

OJ L 370, 31.12.1985, p. 8.

- (h) "smart tachograph 2" means a tachograph complying with the following requirements:
- automatic recording of the border crossing;
  - recording of loading and unloading activities;
  - recording whether the vehicle is used for carriage of goods or passengers; and
  - with the specifications to be set out in the implementing acts referred to in the first paragraph of Article 11 of Regulation (EU) No 165/2014<sup>141</sup>, as adapted by a decision of the Specialised Committee on Road Transport;
- (i) "event" means an abnormal operation detected by the digital tachograph which may result from a fraud attempt;
- (j) "non-valid card" means a card detected as faulty, or whose initial authentication failed, or whose start of validity date is not yet reached, or whose expiry date has passed.

#### Article 3 - Use of driver cards

1. The driver card is personal.
2. A driver may hold no more than one valid driver card, and is only authorised to use his or her own personalised driver card. A driver shall not use a driver card which is defective or which has expired.

#### Article 4 - Issuing of driver cards

1. Driver cards shall be requested to the competent authority in the Party where the driver has his or her normal residence.
2. For the purposes of this Article, "normal residence" means the place where a person usually lives, that is for at least 185 days in each calendar year, because of personal and occupational ties, or, in the case of a person with no occupational ties, because of personal ties which show close links between that person and the place where that person is living.  
  
However, the normal residence of a person whose occupational ties are in a place different from their personal ties and who consequently lives in turn in different places situated in the two Parties shall be regarded as being the place of their personal ties, provided that such person returns there regularly. This last condition does not need to be complied with where the person is living in a Party in order to carry out a fixed-term assignment.
3. Drivers shall give proof of their normal residence by any appropriate means, such as their identity card or any other valid document.

---

<sup>141</sup> Regulation (EU) No 165/2014 of the European Parliament and of the Council of 4 February 2014 on tachographs in road transport, repealing Council Regulation (EEC) No 3821/85 on recording equipment in road transport and amending Regulation (EC) No 561/2006 of the European Parliament and of the Council on the harmonisation of certain social legislation relating to road transport Text with EEA relevance

OJ L 60, 28.2.2014, p. 1

## Article 5 - Renewal of driver cards

Where a driver wishes to renew his or her driver card, the driver shall apply to the competent authorities in the Party of his or her normal residence not later than 15 working days before the expiry date of the card.

## Article 6 - Use of driver cards and record sheets

1. Drivers shall use record sheets or driver cards every day on which they drive, starting from the moment they take over the vehicle. The record sheet or driver card shall not be withdrawn before the end of the daily working period unless its withdrawal is otherwise authorised or is necessary in order to enter the symbol of the country after having crossed a border. No record sheet or driver card may be used to cover a period longer than that for which it is intended.

2. Drivers shall adequately protect the record sheets or driver cards, and shall not use dirty or damaged record sheets or driver cards. The driver shall ensure that, taking into account the length of the period of service, the printing of data from the tachograph at the request of a control officer can be carried out correctly in the event of an inspection.

3. When, as a result of being away from the vehicle, a driver is unable to use the tachograph fitted to the vehicle, the periods of time referred to in points (b)(ii), (b)(iii) and (b)(iv) of paragraph 5 shall:



- (a) if the vehicle is fitted with an analogue tachograph, be entered on the record sheet, either manually, by automatic recording or other means, legibly and without dirtying the record sheet; or
- (b) if the vehicle is fitted with a digital, smart 1 or smart 2 tachograph, be entered onto the driver card using the manual entry facility provided for in the tachograph.

Each Party shall not impose on drivers a requirement to present forms attesting to their activities while away from the vehicle.



4. Where there is more than one driver on board a vehicle fitted with a digital, a smart 1 or smart 2 tachograph, each driver shall ensure that his or her driver card is inserted into the correct slot in the tachograph.

Where there is more than one driver on board a vehicle fitted with an analogue tachograph, the drivers shall amend the record sheets as necessary, so that the relevant information is recorded on the record sheet of the driver who is actually driving.

5. Drivers shall:

- (a) ensure that the time recorded on the record sheet corresponds to the official time in the country of registration of the vehicle;
- (b) operate the switch mechanisms enabling the following periods of time to be recorded separately and distinctly:
  - (i) under the  sign: driving time,
  - (ii) under the  sign: 'other work', which means any activity other than driving, as defined in point (a) of Article 2 of Section 3 of Part B, and

also any work for the same or another employer within or outside of the transport sector,

- (iii) under the  sign: 'availability', as defined in point (b) of Article 2 of Section 3 of Part B,
- (iv) under the  sign: breaks, rest, annual leave or sick leave, and
- (v) under the sign for "ferry/train": In addition to the sign : the  rest period spent on a ferry or train as required in paragraph 12 of Article 6 of Section 2 of Part B.

6. Each driver of a vehicle fitted with an analogue tachograph shall enter the following information on his or her record sheet:

- (a) on beginning to use the record sheet — the driver's surname and first name;
- (b) the date and place where use of the record sheet begins and the date and place where such use ends;
- (c) the registration number of each vehicle to which the driver is assigned, both at the start of the first journey recorded on the record sheet and then, in the event of a change of vehicle, during use of the record sheet;
- (d) the odometer reading:
  - (i) at the start of the first journey recorded on the record sheet;
  - (ii) at the end of the last journey recorded on the record sheet;
  - (iii) in the event of a change of vehicle during a working day, the reading on the first vehicle to which the driver was assigned and the reading on the next vehicle;
- (e) the time of any change of vehicle; and
- (f) the symbols of the countries in which the daily working period started and finished. The driver shall also enter the symbol of the country that the driver enters after crossing a border of an EU Member State and of the United Kingdom at the beginning of the driver's first stop in that Member State or the United Kingdom. That first stop shall be made at the nearest possible stopping place at or after the border. Where the crossing of the border takes place on a ferry or train, the driver shall enter the symbol of the country at the port or station of arrival.

7. The driver shall enter in the digital tachograph the symbols of the countries in which the daily working period started and finished.

From 2 February 2022, the driver shall also enter the symbol of the country that the driver enters after crossing a border of a Member State and of the United Kingdom at the beginning of the driver's first stop in that Member State or the United Kingdom. That first stop shall be made at the nearest possible stopping place at or after the border. Where the crossing of the border takes place on a ferry or train, the driver shall enter the symbol of the country at the port or station of arrival.

A Member State or the United Kingdom may require drivers of vehicles engaged in transport operations inside their territory to add more detailed geographic specifications to the country

symbol, provided that each Party notifies in advance the other Party about those detailed geographic specifications.

It shall not be necessary for drivers to enter the information referred to in the first sentence of the first subparagraph if the tachograph is automatically recording that location data.

#### Article 7 - Correct use of tachographs

1. Transport undertakings and drivers shall ensure the correct functioning and proper use of digital tachographs and driver cards. Transport undertakings and drivers using analogue tachographs shall ensure their correct functioning and the proper use of record sheets.

2. It shall be forbidden to falsify, conceal, suppress or destroy data recorded on the record sheet or stored in the tachograph or on the driver card, or print-outs from the tachograph. Any manipulation of the tachograph, record sheet or driver card which could result in data and/or printed information being falsified, suppressed or destroyed shall also be prohibited. No device which could be used to that effect shall be present on the vehicle.

#### Article 8 - Stolen, lost or defective driver cards

1. Issuing authorities of the Parties shall keep records of issued, stolen, lost or defective driver cards for a period at least equivalent to their period of validity.

2. If a driver card is damaged or if it malfunctions, the driver shall return it to the competent authority in the country of the driver's normal residence. Theft of the driver card shall be formally declared to the competent authorities of the State where the theft occurred.

3. Any loss of the driver card shall be reported in a formal declaration to the competent authorities in the issuing Party and to the competent authorities in the Party of the driver's normal residence if that is different.

4. If the driver card is damaged, malfunctions or is lost or stolen, the driver shall, within seven days, apply for its replacement to the competent authorities in the Party of the driver's normal residence.

5. In the circumstances set out in paragraph 4, the driver may continue to drive without a driver card for a maximum period of 15 days or for a longer period if that is necessary for the vehicle to return to the premises where it is based, provided that the driver can prove the impossibility of producing or using the card during that period.

#### Article 9 - Damaged driver cards and record sheets

1. In the event of damage to a record sheet bearing recordings or to a driver card, drivers shall keep the damaged record sheet or driver card together with any spare record sheet used to replace it.

2. Where a driver card is damaged, malfunctions, or is lost or stolen, the driver shall:

(a) at the start of his or her journey, print out the details of the vehicle that the driver is driving, and enter on that printout:



- (i) details that enable the driver to be identified (name, driver card or driving licence number), including the driver's signature; and
  - (ii) the periods referred to in points (b)(ii), (b)(iii) and (b)(iv) of Article 6(5);
- (b) at the end of the journey, print out the information relating to periods of time recorded by the tachograph, record any periods of other work, availability and rest taken since the printout made at the start of the journey, where not recorded by the tachograph, and mark on that document details enabling the driver to be identified (name, driver card or driving licence number), including the driver's signature.

#### Article 10 - Records to be carried by the driver

1. Where a driver drives a vehicle fitted with an analogue tachograph, the driver shall be able to produce, whenever an authorised control officer so requests:

- (i) the record sheets for the current day and the preceding 28 days;
- (ii) the driver card, if one is held; and
- (iii) any manual records and printouts made during the current day and the previous 28 days.

2. Where the driver drives a vehicle fitted with a digital, a smart 1 or smart 2 tachograph, the driver shall be able to produce, whenever an authorised control officer so requests:

- (i) the driver's driver card;
- (ii) any manual records and printouts made during the current day and the previous 28 days; and
- (iii) the record sheets corresponding to the same period as that referred to in point (ii) during which the driver drove a vehicle fitted with an analogue tachograph.

From 31 December 2024, the period of 28 days referred to in points (i) and (ii) of paragraph 1 and in point (ii) of paragraph 2 shall be replaced by 56 days.

3. An authorised control officer may check compliance with Section 2 of Part B by analysis of the record sheets, of the displayed, printed or downloaded data which have been recorded by the tachograph or by the driver card or, failing that, of any other supporting document that justifies non-compliance with a provision of that Section.

#### Article 11 - Procedures for drivers in the event of malfunctioning equipment

While the tachograph is unserviceable or malfunctioning, the driver shall mark data enabling him to be identified (name, driver card or driving licence number), including a signature, as well as the information for the various periods of time which are no longer recorded or printed out correctly by the tachograph:

- (a) on the record sheet or sheets; or
- (b) on a temporary sheet to be attached to the record sheet or to be kept together with the driver card.

## Article 12 - Enforcement measures

1. Each Party shall adopt all appropriate measures to ensure observance of the provisions of Section 2 to 4 of Part B, in particular by ensuring annually an adequate level of roadside checks and checks performed at the premises of undertakings covering a large and representative cross-section of mobile workers, drivers, undertakings and vehicles of all transport categories falling within the scope of those Sections.

The competent authorities in each Party shall organise the checks so that:

- (i) during each calendar year, a minimum of 3% of the days worked by the drivers of vehicles falling within the scope of Section 2 of Part B applies shall be checked; and
- (ii) at least 30% of the total number of working days checked shall be checked at the roadside and at least 50% at the premises of undertakings.

The elements of roadside checks shall include:

- (i) daily and weekly driving periods, interruptions and daily and weekly rest periods;
- (ii) the record sheets of the preceding days, which shall be on board the vehicle, and/or the data stored for the same period on the driver card and/or in the memory of the tachograph and/or on the printouts, when required; and
- (iii) the correct functioning of the tachograph.

Those checks shall be carried out without discrimination among vehicles, undertakings and drivers whether resident or not, and regardless of the origin or destination of the journey or type of tachograph.

The elements of checks on the premises of undertakings shall include, in addition to the elements subject to roadside checks:

- (i) weekly rest periods and driving periods between those rest periods;
- (ii) fortnightly driving limits;
- (iii) compensation for reduced weekly rest periods in accordance with Article 6(6) and 6(7) of Section 2 of Part B; and
- (iv) use of record sheets and/or vehicle unit and driver card data and printouts and/or the organisation of drivers' working time.

2. If the findings of a roadside check on the driver of a vehicle registered in the territory of the other Party provide grounds to believe that infringements have been committed which cannot be detected during the check due to lack of necessary data, the competent authorities in each Party shall assist each other to clarify the situation. In cases where, to that end, the competent authorities in a Party carry out a check at the premises of the undertaking, the results of that check shall be communicated to the competent authorities of the other Party.

3. The competent authorities in the Parties shall work in cooperation with each other in the organisation of concerted roadside checks.

4. Each Party shall introduce a risk rating system for undertakings based on the relative number and severity of any infringements, as set out in Appendix ROAD.A.1 and of any infringements included in the list drawn up by the Specialised Committee on Road Transport under Article 6(3) of Section 1 of Part A, that an individual undertaking has committed.

5. Undertakings with a high risk rating shall be checked more closely and more often.

6. Each Party and, in the case of the Union, each Member State, shall enable its competent authorities to impose a penalty on a road haulage operator and/or a driver for an infringement of the applicable provisions on driving time, breaks and rest periods detected on its territory and for which a penalty has not already been imposed, even where that infringement has been committed on the territory of the other Party or, in the case of the Union, the territory of a Member State or of a third country.

Appendix ROAD.B.4.1: Adaptations to the technical specifications of the analogue tachograph

**Annex I to Council Regulation (EEC) No 3821/85 is adapted for the purpose of this Section as follows:**

- (a) In Section III (Construction requirements for recording equipment), in paragraph 4.1 of subsection (c) (Recording instruments), for 'Article 15(3), second indent (b), (c) and (d) of the Regulation' substitute 'points (ii), (iii) and (iv) of point (b) of Article 6(5) of Section 4 of Part B of Annex ROAD-1 to the Trade and Cooperation Agreement between the European Union and the European Atomic Energy Community, of the one part, and the United Kingdom of Great Britain and Northern Ireland, of the other part.'
- (b) In Section III (Construction requirements for recording equipment), in paragraph 4.2 of subsection (c) (Recording instruments), for 'Article 15 of the Regulation' substitute 'Article 6(5) of Section 4 of Part B of Annex ROAD-1 to the Trade and Cooperation Agreement between the European Union and the European Atomic Energy Community, of the one part, and the United Kingdom of Great Britain and Northern Ireland, of the other part.'
- (c) In Section IV (Record sheets), in the third subparagraph of paragraph 1 of subsection (a) (General points), for 'Article 15(5) of the Regulation' substitute 'Article 6(6) of Section 4 of Part B of Annex ROAD-1 to the Trade and Cooperation Agreement between the European Union and the European Atomic Energy Community, of the one part, and the United Kingdom of Great Britain and Northern Ireland, of the other part'.
- (d) In Section V (Installation of recording equipment), in the first subparagraph of paragraph 5, for 'this Regulation' substitute 'Section 4 of part B and Section 2 of Part C of Annex ROAD-1 to the Trade and Cooperation Agreement between the European Union and the European Atomic Energy Community, of the one part, and the United Kingdom of Great Britain and Northern Ireland, of the other part'.
- (e) In Section V (Installation of recording equipment), in the third subparagraph of paragraph 5, for 'Part A of Annex II to Council Directive 70/156/EEC' substitute 'the Consolidated Resolution on the Construction of Vehicles (R.E.3)' and for 'the Regulation' substitute 'Section 2 of Part C of Annex ROAD-1 to the Trade and Cooperation Agreement between the European Union and the European Atomic Energy Community, of the one part, and the United Kingdom of Great Britain and Northern Ireland, of the other part'.
- (f) In Section VI (Checks and inspections), in the text before paragraph 1, after 'Member States' insert 'and the United Kingdom'.
- (g) In Section VI (Checks and inspections), in the second subparagraph of paragraph 1 (Certification of new or repaired instruments), after 'Member States' insert 'and the United Kingdom', and for 'the Regulations and its Annexes' substitute 'Section 4 of part B and Section 2 of Part C of Annex ROAD-1 to the Trade and Cooperation Agreement between the European Union and the European Atomic Energy Community, of the one part, and the United Kingdom of Great Britain and Northern Ireland, of the other part'.
- (h) In Section VI (Checks and inspections), in subparagraph (b) of paragraph 3 (Periodic inspections), after 'Member State' insert 'and the United Kingdom'.

Appendix ROAD.B.4.2: Adaptations to the technical specifications of the digital tachograph

**Annex IB to Council Regulation (EEC) No 3821/85, including its appendixes, introduced by Council Regulation (EC) No 2135/98, is adapted for the purpose of this Section as follows:**

1. In the case of the United Kingdom, the references to 'Member State' are replaced by 'Party', except for the references in subsection IV (Construction and functional requirements for tachograph cards), paragraph 174 and subsection VII (Card issuing), paragraph 268a;
2. For 'Council Regulation (EEC) No 3820/85' and 'Regulation (EC) No 561/2006' substitute 'Section 2 of part B of Annex ROAD-1 to the Trade and Cooperation Agreement between the European Union and the European Atomic Energy Community, of the one part, and the United Kingdom of Great Britain and Northern Ireland, of the other part';

**Section I (Definitions) of Annex IB to Council Regulation (EEC) No 3821/85 is adapted for the purpose of this Section as follows:**

3. Point (u) is replaced by the following:

'(u) "effective circumference of the wheels" means the average of the distances travelled by each of the wheels moving the vehicle (driving wheels) in the course of one complete rotation. The measurement of those distances shall be made under standard test conditions as defined under requirement 414 and is expressed in the form "l = ... mm". Vehicle manufacturers may replace the measurement of those distances by a theoretical calculation which takes into account the distribution of the weight on the axles, vehicle unladen in normal running order, namely with coolant fluid, lubricants, fuel, tools, spare-wheel and driver. The methods for such theoretical calculation are subject to approval by the competent authority in a Party and can take place only before tachograph activation;'

4. In point (bb), the reference to 'Council Directive 92/6/EEC' is replaced by 'the applicable law of each Party'.

5. Point (ii) is replaced by the following:

"security certification" means: process to certify, by a Common Criteria certification body, that the recording equipment (or component) or the tachograph card under investigation fulfils the security requirements defined in the relative protection profiles;'

6. In point (mm), the reference to 'Directive 92/23/EEC' is replaced by 'UNECE Regulation No 54'.

7. In point (nn), footnote 17 is replaced by the following:

"Vehicle Identification Number" means a fixed combination of characters assigned to each vehicle by the manufacturer, which consists of two sections: the first, composed of not more than six characters (letters or figures), identifying the general characteristics of the vehicle, in particular the type and model; the second, composed of eight characters of which the first four may be letters or figures and the other four figures only, providing, in conjunction with the first section, clear identification of a particular vehicle.'

8. In point (rr), the first indent is replaced by the following:

'- installed and used only in M1 and N1 type vehicles as defined in the Consolidated Resolution on the Construction of Vehicles (R.E.3)',

*Section II (General characteristics and functions of the recording equipment) of Annex IB to Council Regulation (EEC) No 3821/85 is adapted for the purpose of this Section as follows:*

9. In paragraph 004, the last subparagraph is deleted.

**Section III (Construction and functional requirements for recording equipment) of Annex IB to Council Regulation (EEC) No 3821/85 is adapted for the purpose of this Section as follows:**

10. In paragraph 065, the reference to 'Directive 2007/46/EC' is replaced by 'the Consolidated Resolution on the Construction of Vehicles (R.E.3).'

11. In paragraph 162, the reference to 'Commission Directive 95/54/EC of 31 October 1995 adapting to technical progress Council Directive 72/245/EEC' is replaced by 'UNECE Regulation No 10'.

**Section IV (Construction and functional requirements for tachograph cards) of Annex IB to Council Regulation (EEC) No 3821/85 is adapted for the purpose of this Section as follows:**

12. In paragraph 174, the reference to 'UK: The United Kingdom' is replaced by 'For the United Kingdom, the distinguishing sign shall be the UK.'

13. In paragraph 185, the reference to 'Community territory' is replaced by 'the territory of the Union and of the United Kingdom'.

14. In paragraph 188, the reference to 'Commission Directive 95/54/EC of 31 October 1995' is replaced by 'UNECE Regulation No 10'.

15. In paragraph 189, the last subparagraph is deleted.

**Section V (Installation of recording equipment) of Annex IB to Council Regulation (EEC) No 3821/85 is adapted for the purpose of this Section as follows:**

16. In paragraph 250a, the reference to 'Regulation (EC) No 68/2009' is replaced by 'Appendix 12 of this Annex.'

**Section VI (Checks, inspections and repairs) of Annex IB to Council Regulation (EEC) No 3821/85 is adapted for the purpose of this Section as follows:**

17. The introductory sentence is replaced by the following:

"Requirements on the circumstances in which seals may be removed, as referred to in Article 5(5) of Section 2 of Part C of Annex ROAD-1 to the Trade and Cooperation Agreement between the European Union and the European Atomic Energy Community, of the one part, and the United Kingdom of Great Britain and Northern Ireland, of the other part, are defined in Chapter V(3) of this Annex'

18. Under subsection 1 (Approval of fitters or workshops), the reference to 'Article 12(1) of this Regulation' is replaced by 'Article 8 of Section 2 of part C of Annex ROAD-1 to the Trade and Cooperation Agreement between the European Union and the European Atomic Energy Community, of the one part, and the United Kingdom of Great Britain and Northern Ireland, of the other part'.

**Section VII (Card issuing) of Annex IB to Council Regulation (EEC) No 3821/85 is adapted for the purpose of this Section as follows:**

19. In paragraph 268a, after 'Member States', wherever it occurs, insert 'and the United Kingdom'.

**Section VIII (Type approval of recording equipment and tachograph cards) of Annex IB to Council Regulation (EEC) No 3821/85 is adapted for the purpose of this Section as follows:**

20. In paragraph 271, omit 'in accordance with Article 5 of this Regulation'.

**Appendix 1 (Data dictionary) of Annex IB to Council Regulation (EEC) No 3821/85 is adapted for the purpose of this Section as follows:**

21. In point 2.111, the reference to 'Directive 92/23 (EEC) 31.3.1992, OJ L 129, p. 95' is replaced by 'UNECE Regulation No 54'.

**Appendix 9 (Type approval List of minimum required tests) of Annex IB to Council Regulation (EEC) No 3821/85 is adapted for the purpose of this Section as follows:**

22. In subpoint 5.1 of Section 2 (Vehicle unit functional tests), the reference to 'Directive 95/54/EC' is replaced by 'UNECE Regulation No 10'.

23. In subpoint 5.1 of Section 3 (Motion sensor functional tests), the reference to 'Directive 95/54/EC' is replaced by 'UNECE Regulation No 10'.

**Appendix 12 (Adaptor for M1 and N1 category vehicles) of Annex IB to Council Regulation (EEC) No 3821/85 is adapted for the purpose of this Section as follows:**

24. In Section 4 (Construction and functional requirements for the adaptor) in paragraph 4.5 (performance characteristics) in ADA\_023, for 'Commission Directive 2006/28/EC adapting to technical progress Council Directive 72/245/EEC' substitute 'UNECE Regulation No 10'.

25. In point 5.1 of the table under subsection 7.2 (Functional certificate), for 'Directive 2006/28/EC' substitute 'UNECE Regulation No 10'.

Appendix ROAD.B.4.3: Adaptations to the technical specifications of the smart tachograph

**Commission Implementing Regulation (EU) No 2016/799, including its annexes and appendixes, is adapted for the purpose of this Section as follows:**

1. In the case of the United Kingdom, the references to 'Member State' are replaced by 'Party', except for the references in point (229) of subsection 4.1 and in point (424) of Section 7;
2. For 'Regulation (EEC) No 3820/85' and 'Regulation (EC) No 561/2006' substitute 'Section 2 of Part B of Annex ROAD-1 to the Trade and Cooperation Agreement between the European Union and the European Atomic Energy Community, of the one part, and the United Kingdom of Great Britain and Northern Ireland, of the other part';
3. For 'Regulation (EU) No 165/2014' substitute 'Section 4 of Part B and Section 2 of Part C of Annex ROAD-1 to the Trade and Cooperation Agreement between the European Union and the European Atomic Energy Community, of the one part, and the United Kingdom of Great Britain and Northern Ireland, of the other part, except for the references in point (402) of subsection 5.3 and in point (424) of Section 7';
4. For 'Directive (EU) 2015/719' and for 'Council Directive 96/53/EC' substitute 'Section 1 of Part C of Annex ROAD-1 to the Trade and Cooperation Agreement between the European Union and the European Atomic Energy Community, of the one part, and the United Kingdom of Great Britain and Northern Ireland, of the other part'.

**Section 1 (Definitions) of Annex IC to Commission Implementing Regulation (EU) No 2016/799 is adapted for the purpose of this Section as follows:**

5. Point (u) is replaced by the following:

'(u) "effective circumference of the wheels" means:

the average of the distances travelled by each of the wheels moving the vehicle (driving wheels) in the course of one complete rotation. The measurement of those distances shall be made under standard test conditions as defined under requirement 414 and is expressed in the form "l = ... mm". Vehicle manufacturers may replace the measurement of those distances by a theoretical calculation which takes into account the distribution of the weight on the axles, vehicle unladen in normal running order, namely with coolant fluid, lubricants, fuel, tools, spare-wheel and driver. The methods for such theoretical calculation are subject to approval by the competent authority in a Party and can take place only before tachograph activation;';

6. In point (hh), the reference to 'Council Directive 92/6/EEC' is replaced by 'the applicable law of each Party';
7. In point (uu), the reference to 'Directive 92/23/EEC' is replaced by 'UNECE Regulation No 54';
8. In point (vv), footnote 9 is replaced by the following:

' 'Vehicle Identification Number' means a fixed combination of characters assigned to each vehicle by the manufacturer, which consists of two sections: the first, composed of not more than six characters (letters or figures), identifying the general characteristics of the vehicle, in particular the type and model; the second, composed of eight characters of which the first four may be letters or figures and the other four figures only, providing, in conjunction with the first section, clear identification of a particular vehicle.';



9. In point (yy), the first indent is replaced by the following:

'- installed and used only in M1 and N1 type vehicles as defined in the Consolidated Resolution on the Construction of Vehicles (R.E.3)';

10. Point (aaa) is deleted;

11. In point (ccc), the first paragraph is replaced by '15 June 2019'.

**Section 2 (General characteristics and functions of the recording equipment) of Annex IC to Commission Implementing Regulation (EU) No 2016/799 is adapted for the purpose of this Section as follows:**

12. The last subparagraph of paragraph (7) of subsection 2.1 is deleted.

**Section 3 (Construction and functional requirements for recording equipment) of Annex IC to Commission Implementing Regulation (EU) No 2016/799 is adapted for the purpose of this Section as follows:**

13. In point (200) of subsection 3.20, the second sentence of the third subparagraph is deleted.

14. Point (201) of subsection 3.20 is replaced by the following:

'The vehicle unit may also be able to output the following data using an appropriate dedicated serial link independent from an optional CAN bus connection (ISO 11898 Road vehicles — Interchange of digital information — Controller Area Network (CAN) for high speed communication), to allow their processing by other electronic units installed in the vehicle:

— current UTC date and time,

— speed of the vehicle,

— total distance travelled by the vehicle (odometer),

— currently selected driver and co-driver activity,

— information if any tachograph card is currently inserted in the driver slot and in the co-driver slot and (if applicable) information about the corresponding cards identification (card number and issuing country).

Other data may also be output in addition to that minimum list.

When the ignition of the vehicle is ON, those data shall be permanently broadcast. When the ignition of the vehicle is OFF, at least any change of driver or co-driver activity and/or any insertion or withdrawal of a tachograph card shall generate a corresponding data output. In the event that data output has been withheld whilst the ignition of the vehicle is OFF, that data shall be made available once the ignition of the vehicle is ON again.

The driver consent shall be required in case personal data are transmitted.'

**Section 4 (Construction and functional requirements for tachograph cards) of Annex IC to Commission Implementing Regulation (EU) No 2016/799 is adapted for the purpose of this Section as follows:**

15. In Point (229) of the subsection 4.1, the following subparagraph is added:

'For the United Kingdom, the distinguishing sign shall be the UK.';

16. In point (237), for 'Article 26.4 of Regulation (EU) No. 165/2014' substitute 'Article 9(2) of Section 2 of Part C of Annex ROAD-1 to the Trade and Cooperation Agreement between the European Union and the European Atomic Energy Community, of the one part, and the United Kingdom of Great Britain and Northern Ireland, of the other part';

17. In point (241) of subsection 4.4 of Chapter 4 of this Annex, the word 'Community territory' is replaced by 'the territory of the Union and of the United Kingdom';

18. Point (246) in subsection 4.5 is deleted.

**Section 5 (Installation of recording equipment) of Annex IC to Commission Implementing Regulation (EU) No 2016/799 is adapted for the purpose of this Section as follows:**

19. Point (397) in subsection 5.2 is replaced by the following:

(397) For M1 and N1 vehicles only, and which are fitted with an adaptor in conformity with Appendix 16 of this Annex and where it is not possible to include all the information necessary, as described in Requirement 396, a second, additional, plaque may be used. In such cases, this additional plaque shall contain at least the last four indents described in Requirement 396.';

20. In point (402) of subsection 5.3, for 'Article 22(3) of Regulation (EU) No 165/2014' substitute 'Article 5(3) of Section 2 of Part C of Annex ROAD-1 to the Trade and Cooperation Agreement between the European Union and the European Atomic Energy Community, of the one part, and the United Kingdom of Great Britain and Northern Ireland, of the other part'.

**Section 6 (Checks, inspections and repairs) of Annex IC to Commission Implementing Regulation (EU) No 2016/799 is adapted for the purpose of this Section as follows:**

21. The introductory sentence is replaced by the following:

'Requirements on the circumstances in which seals may be removed are defined in Chapter 5.3 of this Annex'.

**Section 7 (Card issuing) of Annex IC to Commission Implementing Regulation (EU) No 2016/799 is adapted for the purpose of this Section as follows:**

22. In point (424), after the reference to 'Member States' insert 'and the United Kingdom', and for the reference to 'Article 31 of Regulation (EU) No 165/2014' substitute 'Article 13 of Section 2 of Part C of Annex ROAD-1 to the Trade and Cooperation Agreement between the European Union and the European Atomic Energy Community, of the one part, and the United Kingdom of Great Britain and Northern Ireland, of the other part'.

**Appendix 1 (Data dictionary) of Annex IC to Commission Implementing Regulation (EU) No 2016/799 is adapted for the purpose of this Section as follows:**

23. In point 2.163, for 'Directive 92/23/EEC' substitute 'UNECE Regulation No 54'.

**Appendix 11 (Common security mechanisms) of Annex IC to Commission Implementing Regulation (EU) No 2016/799 is adapted for the purpose of this Section as follows:**

24. In point 9.1.4 (Equipment Level: Vehicle Units), in the first note below CSM\_78, for 'Regulation (EU) No 581/2010' substitute 'Article 7(5) of Section 2 of Part B Annex ROAD-1 to the Trade and Cooperation Agreement between the European Union and the European Atomic Energy Community, of the one part, and the United Kingdom of Great Britain and Northern Ireland, of the other part'.

25. In point 9.1.5 (Equipment level: Tachograph Cards), in the note below CSM\_89, for 'Regulation (EU) No 581/2010' substitute 'Article 7(5) of Section 2 of Part B Annex ROAD-1 to the Trade and Cooperation Agreement between the European Union and the European Atomic Energy Community, of the one part, and the United Kingdom of Great Britain and Northern Ireland, of the other part'.

**Appendix 12 (Positioning based on Global Navigation Satellite System (GNSS)) of Annex IC to Commission Implementing Regulation (EU) No 2016/799 is adapted for the purpose of this Section as follows:**

26. The second subparagraph of Section 1 (Introduction) is deleted.

27. In Section 2 (Specification of the GNSS receiver), the reference to 'compatibility with the services provided by the Galileo and European Geostationary Navigation Overlay Service (EGNOS) programmes as set out in Regulation (EU) No 1285/2013 of the European Parliament and of the Council', is replaced by 'compatibility with Satellite Based Augmentation Systems (SBAS)'.

**Appendix 16 (Adaptor for M1 and N1 category vehicles) of Annex IC to Commission Implementing Regulation (EU) No 2016/799 is adapted for the purpose of this Section as follows:**

28. In point 5.1 in the table under Section (7) (Type approval of recording equipment when an adaptor is used), the reference to 'Directive 2006/28/EC' is replaced by 'UNECE Regulation No 10'.

- PART C – Requirements for vehicles used for the transport of goods in accordance with Article ROAD.8 of this Agreement

*Section 1. Weights and dimensions*

Article 1 - Subject matter and principles

The maximum weights and dimensions of the vehicles that may be used for journeys referred to in Article ROAD.4 [Transport of goods between, through and within the territories of the Parties] of this Agreement are those set out in Appendix ROAD C.1.1.

Article 2 - Definitions

For the purposes of this Section, the following definitions apply:

- (a) "motor vehicle" means any power-driven vehicle which travels on the road by its own means;
- (b) "trailer" means any vehicle intended to be coupled to a motor vehicle excluding semitrailers, and constructed and equipped for the carriage of goods;
- (c) "semi-trailer" means any vehicle intended to be coupled to a motor vehicle in such a way that part of it rests on the motor vehicle with a substantial part of its weight and of the weight of its load being borne by the motor vehicle, and constructed and equipped for the carriage of goods;
- (d) "vehicle combination" means either:
  - a road train consisting of a motor vehicle coupled to a trailer; or
  - an articulated vehicle consisting of a motor vehicle coupled to a semi-trailer;
- (e) "conditioned vehicle" means any vehicle whose fixed or movable superstructures are specially equipped for the carriage of goods at controlled temperatures and whose side walls, inclusive of insulation, are each at least 45 mm thick;
- (f) "maximum authorised dimensions" means the maximum dimensions for use of a vehicle;
- (g) "maximum authorised weight" means the maximum weight for use of a laden vehicle;
- (h) "maximum authorised axle weight" means the maximum weight for use of a laden axle or group of axles;
- (i) "tonne" means the weight executed by the mass of a tonne and shall correspond to 9.8 kilonewtons (kN);
- (j) "indivisible load" means a load that cannot, for the purpose of carriage by road, be divided into two or more loads without undue expense or risk of damage and which owing to its dimensions or mass cannot be carried by a motor vehicle, trailer, road train or articulated vehicle complying with this Section in all respects;
- (k) "alternative fuels" means fuels or power sources which serve, at least partly, as a substitute for fossil oil sources in the energy supply to transport and which have the

potential to contribute to its decarbonisation and enhance the environmental performance of the transport sector, consisting of:

- (i) electricity consumed in all types of electric vehicles;
  - (ii) hydrogen;
  - (iii) natural gas, including biomethane, in gaseous form (Compressed Natural Gas — CNG) and liquefied form (Liquefied Natural Gas — LNG);
  - (iv) Liquefied Petroleum Gas (LPG);
  - (v) mechanical energy from on-board storage/on-board sources, including waste heat;
- (l) "alternatively fuelled vehicle" means a motor vehicle powered wholly or in part by an alternative fuel;
- (m) "zero-emission vehicle" means a heavy goods vehicle without an internal combustion engine, or with an internal combustion engine that emits less than 1 g CO<sub>2</sub>/kWh; and
- (n) "intermodal transport operation" means the transport of one or more containers or swap bodies, with a length of no more than 45 feet, where the lorry, trailer, semi-trailer (with or without tractor unit), swap body or container uses the road on the initial and/or final leg of the journey and, on the other leg, rail or inland waterway or maritime services.

#### Article 3 - Special permits

A vehicle or vehicle combination which exceeds the maximum weights and dimensions set out in Appendix Road C.1.1 may only be allowed to circulate on the basis of a special permit issued without discrimination by the competent authorities, or on the basis of similar non-discriminatory arrangements agreed on a case-by-case basis with those authorities, where these vehicles or vehicle combinations carry or are intended to carry indivisible loads.

#### Article 4 - Local restrictions

This Section shall not preclude the non-discriminatory application of road traffic provisions in force in each Party which permit the weight and/or dimensions of vehicles on certain roads or civil engineering structures to be limited.

This includes the possibility to impose local restrictions on maximum authorised dimensions and/or weights of vehicles that may be used in specified areas or on specified roads, where the infrastructure is not suitable for long and heavy vehicles, such as city centres, small villages or places of special natural interest.

#### Article 5 - Aerodynamic devices attached to the rear of vehicles or vehicle combinations

1. Vehicles or vehicle combinations equipped with aerodynamic devices may exceed the maximum lengths provided for in point 1.1 of Appendix ROAD.C.1.1, to allow the addition of such devices to the rear of vehicles or vehicle combinations. Vehicles or vehicle combinations equipped with such devices shall comply with point 1.5 of Appendix ROAD.C.1.1, and any exceeding of the maximum lengths shall not result in an increase in the loading length of those vehicles or vehicle combinations.

2. The aerodynamic devices referred to in paragraph 1 shall fulfil the following operational conditions:

- (a) in circumstances where the safety of other road users or of the driver is at risk, they shall be folded, retracted or removed by the driver;
- (b) when aerodynamic devices and equipment exceed 500 mm in length in the in-use position they shall be retractable or foldable;
- (c) their use on urban and inter-urban road infrastructures shall take into account the special characteristics of areas where the speed limit is less than or equal to 50 km/h and where vulnerable road users are more likely to be present; and
- (d) when retracted/folded, they shall not exceed the maximum authorised length by more than 20 cm.

#### Article 6 - Aerodynamic cabins

Vehicles or vehicle combinations may exceed the maximum lengths laid down in point 1.1 of Appendix ROAD.C.1.1 provided that their cabs deliver improved aerodynamic performance, energy efficiency and safety performance. Vehicles or vehicle combinations equipped with such cabs shall comply with point 1.5 of Appendix ROAD.C.1.1 and any exceeding of the maximum lengths shall not result in an increase in the load capacity of those vehicles.

#### Article 7 - Intermodal transport operations

1. The maximum lengths laid down in point 1.1 of Appendix ROAD.C.1.1, subject where applicable to Article 6, and the maximum distance laid down in point 1.6 of Appendix ROAD.C.1.1, may be exceeded by 15 cm for vehicles or vehicle combinations engaged in the transport of 45-foot containers or 45-foot swap bodies, empty or loaded, provided that the road transport of the container or swap body in question is part of an intermodal transport operation carried out according to the conditions set by each Party.

2. For intermodal transport operations, the maximum authorised vehicle weight for articulate vehicles with five or six axles may be exceeded by two tonnes in the combination set out in point 2.2.2(a) of Appendix ROAD.C.1.1 and by four tonnes in the combination set out in point 2.2.2(b) of Appendix ROAD.C.1.1. The maximum authorised vehicle weight of these vehicles may not exceed 44 tonnes.

#### Article 8 - Proof of compliance

1. As proof of compliance with this Section, vehicles covered by it shall carry one of the following proofs):

- (a) a combination of the following two plates:
  - the manufacturer's statutory plate, which is a plate or label, affixed by the manufacturer on a vehicle that provides the main technical characteristics which are necessary for the identification of the vehicle and provides the competent authorities with the relevant information concerning the permissible maximum laden masses; and

- a plate relating to dimensions as far as possible affixed next to the manufacturer's statutory plate and containing the following information:

- (1) name of the manufacturer;
- (2) vehicle identification number;
- (3) length of the motor vehicle, trailer or semi-trailer (L);
- (4) width of the motor vehicle, trailer or semi-trailer (W); and
- (5) data for the measurement of the length of vehicle combinations:
  - the distance (a) between the front of the motor vehicle and the centre of the coupling device (coupling hook or fifth wheel); in the case of a fifth wheel with several coupling points, the minimum and maximum values must be given ( $a_{\min}$  and  $a_{\max}$ );
  - the distance (b) between the centre of the coupling device of the trailer (fifth wheel ring) or of the semi-trailer (king pin) and the rear of the trailer or of the semi-trailer; in the case of a device with several coupling points, the minimum and maximum values must be given ( $b_{\min}$  and  $b_{\max}$ ).

The length of vehicle combinations is the length of the motor vehicle and trailer or semi-trailer placed in a straight line behind each other.

- (b) a single plate containing the information on the two plates referred to in point (a); or
- (c) a single document issued by the competent authorities of a Party or, in the case of the Union, the Member State where the vehicle is registered or put into circulation containing the same information as the plates referred to in point (a). It shall be kept in a place easily accessible to inspection and shall be adequately protected.

2. If the characteristics of the vehicle no longer correspond to those indicated on the proof of compliance, the Party or, in the case of the Union, the Member State in which the vehicle is registered or put into circulation shall take the necessary steps to ensure that the proof of compliance is altered.
3. The plates and documents referred to in paragraph 1 shall be recognised by the Parties as the proof of vehicle compliance provided for in this Section.

#### Article 9 - Enforcement

1. Each Party shall take specific measures to identify vehicles or vehicle combinations in circulation that are likely to have exceeded the maximum authorised weight and that shall therefore be checked by the competent authorities of the Parties in order to ensure compliance with the requirements of this Section. This can be done with the aid of automatic systems set up on the road infrastructure, or by means of on-board weighing equipment installed in vehicles. Such on-board weighing equipment shall be accurate and reliable, fully interoperable and compatible with all vehicle types.

2. A Party shall not require on-board weighing equipment to be installed on vehicles or vehicle combinations which are registered in the other Party.
3. Where automatic systems are used to establish infringements of this Section and to impose penalties, such automatic systems shall be certified. Where automatic systems are used only for identification purposes, they need not be certified.
4. The Parties shall, in accordance with Article 14 of Section 1 of Part A of this Annex, ensure that their competent authorities exchange information about infringements and penalties relating to this Article.



APPENDIX ROAD.C.1.1: MAXIMUM WEIGHTS AND DIMENSIONS AND RELATED CHARACTERISTICS OF VEHICLES

**1. Maximum authorised dimensions for vehicles (in metre; "m")**

*1.1 Maximum length:*

— motor vehicle	12.00 m
— trailer	12.00 m
— articulated vehicle	16.50 m
— road train	18.75 m

*1.2 Maximum width:*

(a) all vehicles except the vehicles referred to in point (b) 2.55 m

(b) superstructures of conditioned vehicles or conditioned containers 2.60 m  
or swap bodies transported by vehicles

*1.3 Maximum height (any vehicle)* 4.00 m

1.4 Removable superstructures and standardised freight items such as containers are included in the dimensions specified in points 1.1, 1.2, 1.3, 1.6, 1.7, 1.8 and 4.4

1.5 Any motor vehicle or vehicle combination which is in motion must be able to turn within a swept circle having an outer radius of 12.50 m and an inner radius of 5.30 m

1.6 Maximum distance between the axis of the fifth-wheel king pin and the rear of a semi-trailer 12.00 m

1.7 Maximum distance measured parallel to the longitudinal axis of the road train from the foremost external point of the loading area behind the cabin to the rearmost external point of the trailer of the combination, minus the distance between the rear of the drawing vehicle and the front of the trailer 15.65 m

1.8 Maximum distance measured parallel to the longitudinal axis of the road train from the foremost external point of the loading area behind the cabin to the rearmost external point of the trailer of the combination 16.40 m

**2. Maximum authorised vehicle weight (in tonnes)**

*2.1 Vehicles forming part of a vehicle combination*

2.1.1 Two-axle trailer 18 tonnes

2.1.2 Three-axle trailer 24 tonnes

*2.2 Vehicle combinations*

In the case of vehicle combinations including alternatively fuelled or zero-emission vehicles, the maximum authorised weights provided for in this Section are increased by the additional weight of the alternative fuel or zero-emission technology with a maximum of 1 tonne and 2 tonnes respectively.

#### 2.2.1 Road trains with five or six axles

(a) two-axle motor vehicle with three-axle trailer	40 tonnes
(b) three-axle motor vehicle with two or three-axle trailer	40 tonnes

#### 2.2.2 Articulated vehicles with five or six axles

(a) two-axle motor vehicle with three-axle semi-trailer	40 tonnes
(b) three-axle motor vehicle with two or three-axle semi-trailer	40 tonnes

#### 2.2.3 Road trains with four axles consisting of a two-axle motor vehicle and a two-axle trailer

36 tonnes

#### 2.2.4 Articulated vehicles with four axles consisting of a two-axle motor vehicle and a two-axle semi-trailer, if the distance between the axles of the semi-trailer:

is 1.3 m or greater but not more than 1.8 m 36 tonnes

is greater than 1.8 m 36 tonnes (+ 2 tonnes margin when the maximum authorised weight (MAW) of the motor vehicle (18 tonnes) and the MAW of the tandem axle of the semi-trailer (20 tonnes) are respected and the driving axle is fitted with twin tyres and air suspension or equivalent suspension)

### 2.3 Motor vehicles

In the case of alternatively fuelled motor vehicles or zero-emission vehicles, the maximum authorised weights provided for in subsections 2.3.1 and 2.3.2 are increased by the additional weight of the alternative fuel or zero-emission technology with a maximum of 1 tonne and 2 tonnes respectively.

2.3.1 Two-axle motor vehicles 18 tonnes

2.3.2 Three-axle motor vehicles 25 tonnes (26 tonnes where the driving axle is fitted with twin tyres and air suspension or equivalent suspension, or where each driving axle is fitted with twin tyres and the maximum weight of each axle does not exceed 9.5 tonnes)

### 2.3.3 Four-axle motor vehicles with two steering axles

32 tonnes where the driving axle is fitted with twin tyres and air suspension or equivalent suspension, or where each driving axle is fitted with twin tyres and the maximum weight of each axle does not exceed 9.5 tonnes

## 3. Maximum authorised axle weight of the vehicles (in tonnes)

### 3.1 Single axles

Single non-driving axle 10 tonnes

### 3.2 Tandem axles of trailers and semi-trailers

The sum of the axle weights per tandem axle must not exceed, if the distance (d) between the axles is:

- less than 1 m ( $d < 1.0$ )	11 tonnes
- between 1.0 m and less than 1.3 m ( $1.0 \leq d < 1.3$ )	16 tonnes
- between 1.3 m and less than 1.8 m ( $1.3 \leq d < 1.8$ )	18 tonnes
- 1.8 m or more ( $1.8 \leq d$ )	20 tonnes

### 3.3 Tri-axles of trailers and semi-trailers

The sum of the axle weights per tri-axle must not exceed, if the distance (d) between the axles is:

1.3 m or less ( $d \leq 1.3$ )	21 tonnes
over 1.3 m and up to 1.4 m ( $1.3 < d \leq 1.4$ )	24 tonnes

### 3.4 Driving axle

Driving axle of the vehicles referred to in points 2.2 and 2.3 11.5 tonnes

### 3.5 Tandem axles of motor vehicles

The sum of the axle weights per tandem axle must not exceed, if the distance (d) between the axles is:

- less than 1 m ( $d < 1.0$ )	11.5 tonnes
- 1.0 m or greater but less than 1.3 m ( $1.0 \leq d < 1.3$ )	16 tonnes
- 1.3 m or greater but less than 1.8 m ( $1.3 \leq d < 1.8$ )	18 tonnes (19 tonnes where the driving axle is fitted with twin tyres and air suspension or equivalent suspension, or

where each driving axle is fitted with twin tyres

and where the maximum weight for each axle does not exceed 9.5 tonnes)

#### **4. Other characteristics of the vehicles**

##### 4.1 All vehicles

The weight borne by the driving axle or driving axles of a vehicle or vehicle combination must not be less than 25 % of the total laden weight of the vehicle or vehicle combination.

##### 4.2 Road trains

The distance between the rear axle of a motor vehicle and the front axle of a trailer must not be less than 3.00 m.

##### 4.3 Maximum authorised weight depending on the wheelbase

The maximum authorised weight in tonnes of a four-axle motor vehicle may not exceed five times the distance in metres between the axes of the foremost and rearmost axles of the vehicle.

##### 4.4 Semi-trailers

The distance measured horizontally between the axis of the fifth-wheel king pin and any point at the front of the semi-trailer must not exceed 2.04 m.

## *Section 2. Requirements for tachographs, drivers' cards and workshop cards*

### Article 1 - Subject-matter and principles

This Section lays down the requirements for vehicles within the scope of Section 2 of Part B of this Annex regarding the installation, testing, and control of tachographs, as referred to in Article ROAD 8 (2) of this Agreement.

### Article 2 - Definitions

1. For the purposes of this Section, the definitions set out in Article 2 of Section 2 and in Article 2 of Section 4 of Part B of this Annex shall apply.
2. In addition to the definitions referred to in paragraph 1, for the purposes of this Section the following definitions apply:
  - (a) "vehicle unit" means the tachograph excluding the motion sensor and the cables connecting the motion sensor. The vehicle unit may be a single unit or several units distributed in the vehicle, provided that it complies with the security requirements of this Section; the vehicle unit includes, among other things, a processing unit, a data memory, a time measurement function, two smart card interface devices for driver and co-driver, a printer, a display, connectors and facilities for entering the user's inputs;
  - (b) "motion sensor" means a part of the tachograph providing a signal representative of vehicle speed and/or distance travelled;
  - (c) "control card" means a tachograph card issued by the authorities of a Party to a national competent control authority which identifies the control body and, optionally, the control officer, and which allows access to the data stored in the data memory or in the driver cards and, optionally, in the workshop cards for reading, printing and/or downloading;
  - (d) "workshop card" means a tachograph card issued by the authorities of a Party to designated staff of a tachograph manufacturer, a fitter, a vehicle manufacturer or a workshop, approved by that Party, which identifies the cardholder and allows for the testing, calibration and activation of tachographs, and/or downloading from them;
  - (e) "activation" means the phase in which the tachograph becomes fully operational and implements all functions, including security functions, through the use of a workshop card;
  - (f) "calibration" means, with regard to the digital tachograph, updating or confirming vehicle parameters, including vehicle identification and vehicle characteristics, to be held in the data memory through the use of a workshop card;
  - (g) "downloading" from a digital or smart tachograph means the copying, together with the digital signature, of a part, or of a complete set, of data files recorded in the data memory of the vehicle unit or in the memory of a tachograph card, provided that this process does not alter or delete any stored data;
  - (h) "fault" means an abnormal operation detected by the digital tachograph which may result from an equipment malfunction or failure;

- (i) "installation" means the mounting of a tachograph in a vehicle;
- (j) "periodic inspection" means a set of operations performed to check that the tachograph works properly, that its settings correspond to the vehicle parameters, and that no manipulation devices are attached to the tachograph;
- (k) "repair" means any repair of a motion sensor or of a vehicle unit that requires the disconnection of its power supply, or its disconnection from other tachograph components, or the opening of the motion sensor or vehicle unit;
- (l) "interoperability" means the capacity of systems and the underlying business processes to exchange data and to share information;
- (m) "interface" means a facility between systems which provides the media through which they can connect and interact;
- (n) "time measurement" means a permanent digital record of the coordinated universal date and time (UTC); and
- (o) "TACHOnet messaging system" means the messaging system complying with the technical specifications laid down in Annexes I to VII of Commission Implementing Regulation (EU) 2016/68 of 21 January 2016 on common procedures and specifications necessary for the interconnection of electronic registers of driver cards<sup>142</sup>.

#### Article 3 - Installation

##### 1. Tachographs as referred to in paragraph 2 shall be installed in vehicles:

- (a) where the maximum permissible mass of the vehicle, including any trailer, or semitrailer, exceeds 3.5 tonnes; or
- (b) from 1 July 2026, where the maximum permissible mass of the vehicle, including any trailer, or semi-trailer, exceeds 2.5 tonnes.

##### 2. The tachographs are:

- (a) for vehicles put into service for the first time before 1 May 2006, an analogue tachograph;
- (b) for vehicles put into service for the first time between 1 May 2006 and 30 September 2011, the first version of the digital tachograph;
- (c) for vehicles put into service for the first time between 1 October 2011 and 30 September 2012, the second version of the digital tachograph;
- (d) for vehicles put into service for the first time between 1 October 2012 and 14 June 2019, the third version of the digital tachograph;

---

<sup>142</sup> OJ L 15, 22.1.2016, p. 51

- (e) for vehicles registered for the first time from 15 June 2019 and until 2 years after the entry into force of the detailed specifications referred to in Article 2(2)(g) of Section 4 of Part B of this Annex, a smart tachograph 1; and
  - (f) for vehicles registered for the first time more than 2 years after the entry into force of the detailed specifications referred to in Article 2(2)(h) of Section 4 of Part B of this Annex, a smart tachograph 2.
3. Each Party may exempt from the application of this Section the vehicles mentioned in Article 8(3) of Section 2 of Part B of this Annex.
  4. Each Party may exempt from the application of this Section vehicles used for transport operations which have been granted an exception in accordance with Article 8(4) of Section 2 of Part B of this Annex. Each Party shall immediately notify each other when making use of this paragraph.
  5. No later than three years from the end of the year of entry into force of the detailed technical specifications of the smart tachograph 2, vehicles mentioned in point (a) of paragraph 1 which are equipped with an analogue tachograph or a digital tachograph shall be fitted with a smart tachograph 2 when operating on the territory of a Party other than the one where they are registered.
  6. No later than four years after the entry into force of the detailed technical specifications of the smart tachograph 2, vehicles mentioned in point (a) of paragraph 1 equipped with a smart tachograph 1, shall be equipped with a smart tachograph 2 when operating on the territory of a Party other than the one where they are registered.
  7. From 1 July 2026, vehicles mentioned in point (b) of paragraph 1 shall be equipped with a smart tachograph 2 when operating on the territory of a Party other than the one where they are registered.
  8. Nothing in this Section shall affect the application on the Union territory of the Union rules on recording equipment in road transport to Union road haulage operators.

#### Article 4 - Data protection

1. Each Party shall ensure that the processing of personal data in the context of this Section is carried out solely for the purpose of verifying compliance with this Section.
2. Each Party shall, in particular, ensure that personal data are protected against uses other than the one strictly referred to in paragraph 1 in relation to:
  - (a) the use of a global navigation satellite system (GNSS) for the recording of location data as referred to in the technical specification for smart tachograph 1 and smart tachograph 2;
  - (b) the electronic exchange of information on driver cards as referred to in Article 13, and in particular any cross-border exchanges of such data with third Parties; and
  - (c) the keeping of records by road haulage operators as referred to in Article 15.

3. Digital tachographs shall be designed in such a way as to ensure privacy. Only data necessary for the purposes referred to in paragraph 1 shall be processed.
4. Owners of vehicles, road haulage operators and any other entity concerned shall comply with the relevant provisions on the protection of personal data.

#### Article 5 - Installation and repair

1. Tachographs may be installed or repaired only by fitters, workshops or vehicle manufacturers approved by the competent authorities in a Party for that purpose in accordance with Article 7.
2. Approved fitters, workshops or vehicle manufacturers shall seal the tachograph after having verified that it is functioning properly, and, in particular, in such a way as to ensure that no manipulation device can tamper with or alter the data recorded.
3. The approved fitter, workshop or vehicle manufacturer shall place a special mark on the seals which it affixes and, in addition, for digital, smart 1 and smart 2 tachographs, shall enter the electronic security data for carrying out authentication checks. Each Party shall keep and publish a register of the marks and electronic security data used and the necessary information related to the electronic security data used.
4. For the purpose of certifying that the installation of the tachograph took place in accordance with the requirements of this Section, an installation plaque shall be affixed in such a way as to be clearly visible and easily accessible.
5. Tachograph components shall be sealed. Any connections to the tachograph which are potentially vulnerable to tampering, including the connection between the motion sensor and the gearbox, and the installation plaque where relevant, shall be sealed.

A seal shall be removed or broken only:

- by fitters or workshops approved by the competent authorities under Article 7 for repair, maintenance or recalibration purposes of the tachograph, or by control officers properly trained and, where required authorised, for control purposes; or
- for the purpose of vehicle repair or modification which affects the seal. In such cases, a written statement stating the date and time at which the seal was broken and giving the reasons for the seal removal shall be kept on board the vehicle.

The removed or broken seals shall be replaced by an approved fitter or a workshop without undue delay and at the latest within seven days of their removal or breaking. When the seals have been removed or broken for control purposes, they may be replaced by a control officer equipped with sealing equipment and a unique special mark without undue delay.

When a control officer removes a seal, the control card shall be inserted in the tachograph from the moment of the removal of the seal until the inspection is finished, including in the case of the placement of a new seal. The control officer shall issue a written statement containing at least the following information:

- vehicle identification number;



- name of the officer;
- control authority and country;
- number of the control card;
- number of the removed seal;
- date and time of seal removal; and
- number of the new seal, where the control officer has placed a new seal.

Before replacing the seals, a check and calibration of the tachograph shall be performed by an approved workshop, except where a seal has been removed or broken for control purposes and replaced by a control officer.

#### Article 6 - Inspections of tachographs

1. Tachographs shall be subject to regular inspection by approved workshops. Regular inspections shall be carried out at least every two years.
2. The inspections referred to in paragraph 1 shall check at least the following:
  - the tachograph is correctly fitted and appropriate for the vehicle;
  - the tachograph is working properly;
  - the tachograph carries the type-approval mark;
  - the installation plaque is affixed;
  - all seals are intact and effective;
  - there are no manipulation devices attached to the tachograph or traces of the use of such devices; and
  - the tyre size and the actual circumference of the tyres.
3. Workshops shall draw up an inspection report in cases where irregularities in the functioning of the tachograph had to be remedied, whether as a result of a periodic inspection or of an inspection carried out at the specific request of the national competent authority. They shall keep a list of all inspection reports drawn up.
4. Inspection reports shall be retained for a minimum period of two years from the time the report was made. Each Party shall decide whether inspection reports are to be retained or sent to the competent authority during that period. In cases where the inspection reports are kept by the workshop, upon request from the competent authority, the workshop shall make available the reports of inspections and calibrations carried out during that period.

## Article 7 - Approval of fitters, workshops and vehicle manufacturers

1. Each Party or, in the case of the Union, each Member State shall approve, regularly control and certify the fitters, workshops and vehicle manufacturers which may carry out installations, checks, inspections and repairs of tachographs.
2. Each Party or, in the case of the Union, each Member State shall ensure that fitters, workshops and vehicle manufacturers are competent and reliable. For that purpose, they shall establish and publish a set of clear national procedures and shall ensure that the following minimum criteria are met:
  - (a) the staff are properly trained;
  - (b) the equipment necessary to carry out the relevant tests and tasks is available; and
  - (c) the fitters, workshops and vehicle manufacturers are of good repute.
3. Audits of approved fitters or workshops shall be carried out as follows:
  - (a) approved fitters or workshops shall be subject, at least every two years, to an audit of the procedures they apply when handling tachographs. The audit shall focus in particular on the security measures taken and the handling of workshop cards. Parties or, in the case of the Union, Member States may carry out these audits without conducting a site visit; and
  - (b) unannounced technical audits of approved fitters or workshops shall also take place in order to check the calibrations, inspections and installations carried out. Those audits shall cover at least 10 % of the approved fitters and workshops annually.
4. Each Party and their competent authorities shall take appropriate measures to prevent conflicts of interests between fitters or workshops and road haulage operators. In particular, where there is a serious risk of a conflict of interests, additional specific measures shall be taken to ensure that the fitter or workshop complies with this Section.
5. The competent authorities of each Party shall withdraw approvals, either temporarily or permanently, from fitters, workshops and vehicle manufacturers which fail to meet their obligations under this Section.

## Article 8 - Workshop cards

1. The period of validity of workshop cards shall not exceed one year. When renewing the workshop card, the competent authority shall ensure that the criteria listed in Article 7(2) are met by the fitter, workshop or vehicle manufacturer.
2. The competent authority shall renew a workshop card within 15 working days after receipt of a valid renewal request and all the necessary documentation. If a workshop card is damaged, malfunctions, or is lost or stolen, the competent authority shall supply a replacement card within five working days of receiving a detailed request to that effect. Competent authorities shall maintain a register of lost, stolen or defective cards.

3. If a Party or, in the case of the Union, a Member State withdraws the approval of a fitter, workshop or vehicle manufacturer as provided for in Article 7, it shall also withdraw the workshop cards issued thereto.
4. Each Party shall take all necessary measures to prevent the workshop cards distributed to approved fitters, workshops and vehicle manufacturers from being falsified.

#### Article 9 - Issuing of driver cards

1. Driver cards shall be issued, at the request of the driver, by the competent authority in a Party where the driver has his normal residence. Where the competent authorities in a Party issuing the driver card have doubts as to the validity of a statement as to normal residence, or for the purpose of certain specific controls, they may request any additional information or evidence from the driver.

For the purposes of this Article, "normal residence" means the place where a person usually lives, that is for at least 185 days in each calendar year, because of personal and occupational ties, or, in the case of a person with no occupational ties, because of personal ties which show close links between that person and the place where he is living.

However, the normal residence of a person whose occupational ties are in a place different from their personal ties and who consequently lives in turn in different places situated in the two Parties shall be regarded as being the place of their personal ties, provided that such person returns there regularly. This last condition need not be complied with where the person is living in a Party in order to carry out a fixed-term assignment.

2. In duly justified and exceptional cases, each Party or, in the case of the Union, a Member State may issue a temporary and non-renewable driver card valid for a maximum period of 185 days to a driver who does not have his normal residence in a Party, provided that such driver is in a labour law relationship with an undertaking established in the issuing Party and, in so far, presents a driver attestation when required.

3. The competent authorities of the issuing Party shall take appropriate measures to ensure that an applicant does not already hold a valid driver card and shall personalise the driver card, ensuring that its data are visible and secure.

4. The driver card shall not be valid for more than five years.

5. A valid driver card shall not be withdrawn or suspended unless the competent authorities of a Party find that the card has been falsified, or the driver is using a card of which he is not the holder, or the card held has been obtained on the basis of false declarations and/or forged documents. If such suspension or withdrawal measures are taken by a Party or, in the case of the Union, a Member State other than the issuing Party or, in the case of the Union, other than the issuing Member State, the former shall return the card to the authorities of the Party or, in the case of the Union, the authorities of the Member State which issued it, as soon as possible, indicating the reasons for the withdrawal or suspension. If the return of the card is expected to take longer than two weeks, the suspending or withdrawing Party or, in the case of the Union, the suspending or withdrawing Member State shall inform the issuing Party or, in the case of the Union, the issuing Member State within those two weeks of the reasons for suspension or withdrawal.

6. The competent authority of the issuing Party may require a driver to replace the driver card by a new one if this is necessary to comply with the relevant technical specifications.

7. Each Party shall take all necessary measures to prevent driver cards from being falsified.

8. This Article shall not prevent a Party or, in the case of the Union, a Member State from issuing a driver card to a driver who has his normal residence in a part of that Party's territory, to which this Annex does not apply, provided that the relevant provisions of this Section are applied in such cases.

#### Article 10 - Renewal of driver cards

1. Where, in the case of renewals, the Party of the driver's normal residence is different from that which issued his current card, and where the authorities of the former Party are requested to renew the driver card, they shall inform the authorities which issued the earlier card of the reasons for its renewal.
2. In the event of a request for the renewal of a card which is imminently about to expire, the competent authority shall supply a new card before the expiry date, provided that the request was sent within the time-limits laid down in Article 5 of Section 4 of Part B of this Annex.

#### Article 11 - Stolen, lost or defective driver cards

1. Issuing authorities shall keep records of issued, stolen, lost or defective driver cards for a period at least equivalent to their period of validity.
2. If the driver card is damaged, malfunctions or is lost or stolen, the competent authorities in the Party of his normal residence shall supply a replacement card within eight working days after their receipt of a detailed request to that effect.

#### Article 12 - Mutual acceptance of driver cards

1. Each Party shall accept the driver cards issued by the other Party.
2. Where the holder of a valid driver card issued by a Party has established his normal residence in the other Party and has asked for his card to be exchanged for an equivalent driver card, it shall be the responsibility of the Party or, in the case of the Union, the Member State which carries out the exchange to verify whether the card produced is still valid.
3. Parties or, in the case of the Union, Member States carrying out an exchange shall return the old card to the authorities of the issuing Party or, in the case of the Union, the issuing Member State and indicate the reasons for so doing.
4. Where a Party or, in the case of the Union, a Member State replaces or exchanges a driver card, the replacement or exchange, and any subsequent replacement or exchange, shall be registered in that Party or, in the case of the Union, in that Member State.

### Article 13 - Electronic exchange of information on driver cards

1. In order to ensure that an applicant does not already hold a valid driver card, Parties or, in the case of the Union, Member States shall maintain national electronic registers containing the following information on driver cards for a period at least equivalent to the period of validity of those cards:
  - surname and first name of the driver;
  - birth date and, if available, place of birth of the driver;
  - valid driving licence number and country of issue of the driving licence (if applicable);
  - status of the driver card; and
  - driver card number.
2. The electronic registers of the Parties or, in the case of the Union, the Member States shall be interconnected and accessible throughout the territory of the Parties, using the TACHOnet messaging system or a compatible system. In the case of the use of a compatible system, the exchange of electronic data with the other Party shall be possible through the TACHOnet messaging system.
3. When issuing, replacing and, where necessary, renewing a driver card, Parties or, in the case of the Union, Member States shall verify through electronic data exchange that the driver does not already hold another valid driver card. The data exchanged shall be limited to the data necessary for the purpose of this verification.
4. Control officers may have access to the electronic register in order to check the status of a driver card.

### Article 14 - Settings of tachographs

1. Digital tachographs shall not be set in such a way that they automatically switch to a specific category of activity when the vehicle's engine or ignition is switched off, unless the driver remains able to choose manually the appropriate category of activity.
2. Vehicles shall not be fitted with more than one tachograph, except for the purposes of field tests.
3. Each Party shall forbid the production, distribution, advertising and/or selling of devices constructed and/or intended for the manipulation of tachographs.

### Article 15 - Responsibility of road haulage operators

1. Road haulage operators shall be responsible for ensuring that their drivers are properly trained and instructed as regards the correct functioning of tachographs, whether digital, smart or analogue, shall make regular checks to ensure that their drivers make correct use thereof, and shall not give to their drivers any direct or indirect incentives that could encourage the misuse of tachographs.

Road haulage operators shall issue a sufficient number of record sheets to drivers of vehicles fitted with analogue tachographs, taking into account the fact that record sheets are personal in character,

the length of the period of service and the possible need to replace record sheets which are damaged or have been taken by an authorised control officer. Road haulage operators shall issue to drivers only record sheets of an approved model suitable for use in the equipment installed in the vehicle.

The road haulage operator shall ensure that, taking into account the length of the period of service, the printing of data from the tachograph at the request of a control officer can be carried out correctly in the event of an inspection.

2. Road haulage operators shall keep record sheets and printouts, whenever printouts have been made to comply with Article 9 of Section 4 of Part B of this Annex, in chronological order and in a legible form, for at least a year after their use, and shall give copies to the drivers concerned who request them. Road haulage operators shall also give copies of data downloaded from driver cards to the drivers concerned who request them, together with printed paper versions of those copies. Record sheets, printouts and downloaded data shall be produced or handed over at the request of any authorised control officer.
3. Road haulage operators shall be liable for infringements of this Section and of Section 4 of Part B of this Annex committed by their drivers or by drivers at their disposal. However, each Party may make such liability conditional on the road haulage operator's infringement of the first subparagraph of paragraph 1 of this Article and Article 7(1) and (2) of Section 2 of Part B of this Annex.

#### Article 16 - Procedures for road haulage operators in the event of malfunctioning equipment

1. In the event of the breakdown or faulty operation of a tachograph, the road haulage operator shall have it repaired by an approved fitter or workshop, as soon as circumstances permit.
2. If the vehicle is unable to return to the road haulage operator's premises within a period of one week calculated from the day of the breakdown or of the discovery of defective operation, the repair shall be carried out en route.
3. Each Party or, in the case of the Union, the Member States shall give the competent authorities power to prohibit the use of the vehicle in cases where the breakdown or faulty operation has not been remedied as provided in paragraphs 1 and 2 in so far as this is in accordance with the national legislation in the Party concerned.

#### Article 17 - Procedure for the issuing of tachograph cards

The European Commission shall provide to the competent authorities of the United Kingdom the cryptographic material for the issuing of tachograph cards for drivers, workshops and control authorities, in accordance with the European Root Certification Authority (ERCA) certificate policy and the certificate policy of the United Kingdom.

ANNEX ROAD-2: MODEL OF AUTHORISATION FOR AN INTERNATIONAL REGULAR AND SPECIAL  
REGULAR SERVICE

(First page of authorisation)

(Orange paper – DIN A4)

(To be worded in the official language(s) or one of the official languages of the Party  
where the request is made)

**Authorisation**

In accordance with Title I of Heading Three of Part Two [Transport of goods by road] of the Trade and Cooperation Agreement between the European Union and the European Atomic Energy Community, of the one part, and the United Kingdom of Great Britain and Northern Ireland, of the other part,

ISSUING STATE: .....

Authorising authority: .....

Issuing State distinguishing sign: ..... <sup>(143)</sup>

**AUTHORISATION**

**No.:**

..... for a regular service  <sup>(2)</sup>

for a special regular service  <sup>(2)</sup>

by coach and bus between the Parties to the Trade and Cooperation Agreement between the European Union and the European Atomic Energy Community, of the one part, and the United Kingdom of Great Britain and Northern Ireland, of the other part,

To: .....

.....  
Last name, first name or trade name of the operator or of the managing operator in the case of a group of undertakings or in the case of a partnership:

Address:

.....

.....

...

Telephone and fax or e-mail:

.....

<sup>143</sup> Austria (A), Belgium (B), Bulgaria (BG), Cyprus (CY), Croatia (HR), Czech Republic (CZ), Denmark (DK), Estonia (EST), Finland (FIN), France (F), Germany (D), Greece (GR), Hungary (H), Ireland (IRL), Italy (I), Latvia (LV), Lithuania (LT), Luxembourg (L), Malta (MT), Netherlands (NL), Poland (PL), Portugal (P), Romania (RO), Slovak Republic (SK), Slovenia (SLO), Spain (E), Sweden (S), United Kingdom (UK), to be completed.

<sup>2</sup> Tick or complete as appropriate.

.....

(Second page of authorisation)

Name, address, telephone and fax or e-mails of the operator, or, in the case of groups of operators or partnerships, the names of all operators of the group or of the partnership; in addition, names of any subcontractors, to be identified as such:

- (1) .....
- (2) .....
- (3) .....
- (4) .....
- (5) .....

List attached, if appropriate

Validity of the authorisation: From: ..... To: .....

Place and date of issue: .....

Signature and stamp of the issuing authority or agency: .....

1. Route: .....

.....

(a) Place of departure of service: .....

.....

(b) Place of destination of service: .....

.....

Principal itinerary, with passenger pick-up and set-down points underlined: .....

.....

2. Timetable: .....

(attached to this authorisation)

3. Special regular service:

(a) Category of passengers: .....

.....

4. Other conditions or special points .....

.....

.....

Stamp of authority issuing the authorisation

**Important notice:**



- (1) This authorisation is valid for the entire journey.
- (2) The authorisation or a true copy certified by the issuing authorising authority shall be kept on the vehicle for the duration of the journey and shall be presented to enforcement officials on request.
- (3) The departure or destination shall take place in the territory of the Party where the operator is established and the coaches and buses registered.

(Third page of authorisation)

### GENERAL CONSIDERATIONS

- (1) The road passenger transport operator shall begin the transport service within the period indicated in the decision of the authorising authority granting the authorisation.
- (2) Except in the event of *force majeure*, the operator of an international regular or special regular service shall take all measures to guarantee a transport service that complies with the conditions as stipulated in the authorisation.
- (3) The operator shall make the information about the route, the stopping points, the timetable, the fares and the conditions of transport publicly available.
- (4) Without prejudice to documents pertaining to the vehicle and driver (such as the vehicle registration certificate and driving licence), the following documents shall serve as control documents required under Article X+4 of Title II of Heading Three of Part Two [Transport of passengers by road] of Trade and Cooperation Agreement between the European Union and the European Atomic Energy Community, of the one part, and the United Kingdom of Great Britain and Northern Ireland, of the other part and shall be kept in the vehicle and presented at the request of any authorised inspecting officer:
  - the authorisation or a certified true copy thereof to carry out international regular or special regular services;
  - the operator's licence or a certified true copy thereof for the international carriage of passengers by road provided for according to the United Kingdom or Union legislation;
  - when operating an international special regular service, the contract between the organiser and the transport operator or a certified true copy thereof as well as a document evidencing that the passengers constitute a specific category to the exclusion of other passengers for the purposes of a special regular service;
  - when the operator of a regular or special regular service uses additional vehicles to deal with temporary and exceptional situations, in addition to the relevant documents mentioned above, a copy of the contract between the operator of the international regular or special regular service and the undertaking providing the additional vehicles or an equivalent document.

(Fourth page of authorisation)

**GENERAL CONSIDERATIONS (cont.)**

- (5) Operators operating an international regular service, with the exclusion of special regular service, shall issue transport tickets confirming the rights of the passenger to be transported and serving as a control document evidencing of the conclusion of the contract of carriage between the passenger and the transport operator, either individual or collective. The tickets that can also be electronic shall indicate:
- (a) the name of the operator;
  - (b) the points of departure and destination and, if applicable, the return journey;
  - (c) the period of validity of the ticket and, if applicable, the date and time of departure;
  - (d) the price of transport.

The transport ticket shall be presented, by the passenger, at the request of any authorised inspection officer.

- (6) Operators operating international regular or special regular passenger transport services shall allow all inspections intended to ensure that operations are being conducted correctly, in particular as regards driving and rest periods and road safety and emissions.
-

ANNEX ROAD-3: MODEL OF APPLICATION FOR AN AUTHORISATION FOR AN INTERNATIONAL  
REGULAR AND SPECIAL REGULAR SERVICE

(White paper – DIN A4)

(To be worded in the official language(s) or one of the official languages of the Party  
where the request is made)

**APPLICATION FORM FOR AN AUTHORISATION OR RENEWAL OF AN  
AUTHORISATION TO CARRY OUT AN INTERNATIONAL REGULAR SERVICE  
OR AN INTERNATIONAL SPECIAL REGULAR SERVICE <sup>(144)</sup>**

To start a regular service

To start a special regular service

To renew authorisation for a service

To alter the conditions of authorisation for a service

carried out by coach and bus between Parties in accordance with the Trade and Cooperation Agreement between the European Union and the European Atomic Energy Community, of the one part, and the United Kingdom of Great Britain and Northern Ireland, of the other part,

.....  
(Authorising authority)

1. Name and first name or trade name of the applicant operator; in the case of an application by a group of operators or by a partnership, the name of the operator entrusted by the other operators for the purposes of submitting the application:  
.....  
.....

2. Services to be carried out <sup>(1)</sup>

By an operator  by a group of operators  by a partnership  by a subcontractor

3. Names and addresses of the operator or, in the case of a group of operators or of a partnership, the names of all operators of the group or of the partnership; in addition, any subcontractors shall be identified by their names <sup>(2)</sup>

3.1 ..... tel. ....

3.2 ..... tel. ....

3.3 ..... tel. ....

3.4 ..... tel. ....

(Second page of the application for authorisation or renewal of authorisation)

144 Tick or complete as appropriate

<sup>2</sup> Attach list if applicable.

4 In the case of a special regular service:

4.1 Category of passengers: <sup>(145)</sup> workers  school pupils/students  other

5 Duration of authorisation requested or date on which the service ends:

.....

6 Principal route of service (underline passenger pick-up and set-down points, with full addresses): <sup>(146)</sup>

.....

.....

.....

7 Period of operation: .....

.....

.....

8 Frequency (daily, weekly, etc.): .....

9 Fares ..... Annex attached.

10 Enclose a driving schedule to permit verification of compliance with the international rules on driving times and rest time periods.

11 Number of authorisations or of certified true copies of authorisations requested: ( <sup>3</sup> )

.....

12 Any additional information:

.....

(Place and date) (Signature of applicant)

.....

The attention of the applicant is drawn to the fact that, since the authorisation or its certified true copy has to be kept on board the vehicle, the number of authorisations or certified true copies, issued by the authorising authority, which the applicant must have should correspond to the number of vehicles needed for carrying out the service requested at the same time.

#### **Important notice**

In particular the following must be attached to the application:

- (a) the timetable including the time slots for controls at relevant border crossings;
- (b) a certified true copy of the operator's (or operators') licence(s) for the international carriage of passengers by road provided for according to national or Union legislation;
- (c) a map on an appropriate scale on which are marked the route and the stopping points at which passengers are to be taken up or set down;
- (d) a driving schedule to permit verification of compliance with the international rules on driving times and rest periods;
- (e) any appropriate information concerning coach and bus terminals.

---

<sup>145</sup> Tick or complete as appropriate.

<sup>146</sup> The authorising authority may request a full list of passenger pick-up and set-down points with full addresses to be attached separately to this application form. <sup>3</sup> Complete as appropriate.







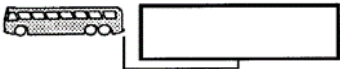

ANNEX ROAD-4: MODEL OF JOURNEY FORM FOR OCCASIONAL SERVICES

JOURNEY FORM No..... of Book No.....

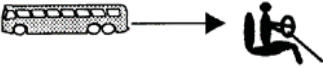
(colour Pantone 358 (light green), or as close as possible to this colour, format DIN A4 uncoated paper)

OCCASIONAL SERVICES WITH CABOTAGE AND OCCASIONAL SERVICES WITH TRANSIT

(Each item, if necessary, can be supplemented on a separate sheet)

1	 Registration number of the coach	.....  Place, date and signature of the carrier																																																															
2	  Carrier and, where appropriate, subcontractor or group of carriers	1. .... 2. .... 3. ....																																																															
3	  Name of driver(s)	1. .... 2. .... 3. ....																																																															
4	Organisation of person responsible for the occasional service	1. .... 2. ....  3. .... 4. ....																																																															
5	<b>Type of service</b>	<input type="checkbox"/> Occasional service with cabotage  <input type="checkbox"/> Occasional service with transit																																																															
6	Place of departure of service: ..... Country: .....  Place of destination of service: ..... Country: .....																																																																
7	<table border="1" style="width: 100%; border-collapse: collapse;"> <thead> <tr> <th style="width: 15%;">Journey</th> <th style="width: 35%;">Route/Daily stages and/or passenger pick-up or set-down points</th> <th style="width: 15%;">Number of passengers</th> <th style="width: 15%;">Empty (mark with an X)</th> <th style="width: 20%;">Planned km</th> </tr> <tr> <th style="text-align: center;">Dates</th> <th style="text-align: center;">from  To</th> <th style="text-align: center;"></th> <th style="text-align: center;"></th> <th></th> </tr> </thead> <tbody> <tr><td> </td><td> </td><td> </td><td> </td><td> </td></tr> <tr><td> </td><td> </td><td> </td><td> </td><td> </td></tr> <tr><td> </td><td> </td><td> </td><td> </td><td> </td></tr> <tr><td> </td><td> </td><td> </td><td> </td><td> </td></tr> <tr><td> </td><td> </td><td> </td><td> </td><td> </td></tr> <tr><td> </td><td> </td><td> </td><td> </td><td> </td></tr> <tr><td> </td><td> </td><td> </td><td> </td><td> </td></tr> <tr><td> </td><td> </td><td> </td><td> </td><td> </td></tr> <tr><td> </td><td> </td><td> </td><td> </td><td> </td></tr> <tr><td> </td><td> </td><td> </td><td> </td><td> </td></tr> </tbody> </table>	Journey	Route/Daily stages and/or passenger pick-up or set-down points	Number of passengers	Empty (mark with an X)	Planned km	Dates	from  To																																																									
Journey	Route/Daily stages and/or passenger pick-up or set-down points	Number of passengers	Empty (mark with an X)	Planned km																																																													
Dates	from  To																																																																
8	Connection points, if any, with another carrier in the same group	Number of passengers set down	Final destination of the passengers set down	Carrier picking up the passengers																																																													

9	Unforeseen changes			
	.....			
	.....			

ANNEX FISH.1

#	Code	Common Name	ICES Areas	Shares													
				2021		2022		2023		2024		2025		2026 onwards			
				EU	UK	EU	UK	EU	UK	EU	UK	EU	UK	EU	UK		
1	ALF/3X14-	Alfonosinos (3,4,5,6,7,8,9,10,12,14)	UK, Union and international waters of 3, 4, 5, 6, 7, 8, 9, 10, 12 and 14	96.95	3.05	96.95	3.05	96.95	3.05	96.95	3.05	96.95	3.05	96.95	3.05	96.95	3.05
2	ANF/07.	Anglerfish (7)	7	78.78	21.22	78.24	21.76	77.70	22.30	77.05	22.95	76.62	23.38	76.62	23.38	76.62	23.38
3	ANF/2AC4-C	Anglerfish (North Sea)	UK and Union waters of 4; UK waters of 2a	13.74	86.26	12.92	87.08	12.11	87.89	11.13	88.87	10.48	89.52	10.48	89.52	10.48	89.52
4	ANF/56-14	Anglerfish (West of Scotland)	6; UK and international waters of 5b; international waters of 12 and 14	60.99	39.01	59.62	40.38	58.25	41.75	56.60	43.40	55.50	44.50	55.50	44.50	55.50	44.50
5	ARU/1/2.	Greater Silver Smelt (1,2)	UK and international waters of 1 and 2	56.90	43.10	56.90	43.10	56.90	43.10	56.90	43.10	56.90	43.10	56.90	43.10	56.90	43.10
6	ARU/3A4-C	Greater Silver Smelt (North Sea)	UK and Union waters of 4; Union waters of 3a	98.40	1.60	98.40	1.60	98.40	1.60	98.40	1.60	98.40	1.60	98.40	1.60	98.40	1.60
7	ARU/567.	Greater Silver Smelt (Western)	6 and 7; UK and international waters of 5	94.41	5.59	94.41	5.59	94.41	5.59	94.41	5.59	94.41	5.59	94.41	5.59	94.41	5.59
8	BL/12INT-	Blue Ling (International 12)	International waters of 12	99.14	0.86	99.14	0.86	99.14	0.86	99.14	0.86	99.14	0.86	99.14	0.86	99.14	0.86
9	BL/24-	Blue Ling (North Sea)	UK and international waters of 2; UK and Union waters of 4	73.19	26.81	73.19	26.81	73.19	26.81	73.19	26.81	73.19	26.81	73.19	26.81	73.19	26.81
10	BL/5B67-	Blue Ling (Western)	6 and 7; UK and international waters of 5	77.31	22.69	76.73	23.27	76.16	23.84	75.46	24.54	75.00	25.00	75.00	25.00	75.00	25.00
11	BOR/678-	Boarfish (Western)	6, 7 and 8	93.65	6.36	93.65	6.36	93.65	6.36	93.65	6.36	93.65	6.36	93.65	6.36	93.65	6.36
12	BSF/56712-	Black Scabbardfish (Western)	6 and 7; UK and international waters of 5; international waters of 12	94.31	5.69	94.31	5.69	94.31	5.69	94.31	5.69	94.31	5.69	94.31	5.69	94.31	5.69
13	COD/07A.	Cod (Irish Sea)	7a	56.05	43.95	55.84	44.16	55.63	44.37	55.37	44.63	55.20	44.80	55.20	44.80	55.20	44.80
14	COD/07D.	Cod (Eastern Channel)	7d	90.75	9.25	90.75	9.25	90.75	9.25	90.75	9.25	90.75	9.25	90.75	9.25	90.75	9.25
15	COD/5BE6A	Cod (West of Scotland)	6a; UK and international waters of 5b east of 12°00' W	30.23	69.77	27.37	72.63	24.51	75.49	21.08	78.92	18.79	81.21	18.79	81.21	18.79	81.21
16	COD/5W6-14	Cod (Rockall)	6b; UK and international waters of 5b west of 12°00' W and of 12 and 14	33.95	66.05	31.71	68.29	29.47	70.53	26.78	73.22	24.99	75.01	24.99	75.01	24.99	75.01
17	COD/7XAD34	Cod (Celtic Sea)	7b, 7c, 7e-k, 8, 9 and 10; Union waters of CECAF 34.1.1	90.70	9.30	90.47	9.53	90.23	9.77	89.95	10.05	89.76	10.24	89.76	10.24	89.76	10.24
18	DGS/15X14	Spurdoc (Western)	6, 7 and 8; UK and international waters of 5; international waters of 1, 12 and 14	57.53	42.47	56.61	43.39	55.69	44.31	54.58	45.42	53.84	46.16	53.84	46.16	53.84	46.16
19	DWS/56789-	Deep-sea Sharks (Western)	6, 7, 8 and 9; UK and international waters of 5	100.00	0.00	100.00	0.00	100.00	0.00	100.00	0.00	100.00	0.00	100.00	0.00	100.00	0.00
20	HAD/07A.	Haddock (Irish Sea)	7a	47.24	52.76	46.42	53.58	45.61	54.39	44.63	55.37	43.98	56.02	43.98	56.02	43.98	56.02
21	HAD/5BC6A.	Haddock (West of Scotland)	6a; UK and international waters of 5b	19.39	80.61	19.39	80.61	19.39	80.61	19.39	80.61	19.39	80.61	19.39	80.61	19.39	80.61
22	HAD/6B1214	Haddock (Rockall)	UK, Union and international waters of 6b; international waters 12 and 14	16.76	83.24	16.32	83.68	15.88	84.12	15.35	84.65	15.00	85.00	15.00	85.00	15.00	85.00
23	HAD/7X7A34	Haddock (Celtic Sea)	7b-k, 8, 9 and 10; Union waters of CECAF 34.1.1	84.00	16.00	83.00	17.00	82.00	18.00	80.80	19.20	80.00	20.00	80.00	20.00	80.00	20.00
24	HER/07A/MM	Herring (Irish Sea)	7a north of 52°30'N	11.01	88.99	8.50	91.50	6.00	94.00	2.99	97.01	0.99	99.01	0.99	99.01	0.99	99.01

25	HER/5B6ANB	Herring (West of Scotland)	6b and 6aN, UK and international waters 5b	35.95	64.05	35.34	64.66	34.74	65.26	34.01	65.99	33.53	66.47	33.53	66.47	33.53	66.47
26	HER/7EF.	Herring (Western Channel and Bristol Channel)	7e and 7f	50.00	50.00	50.00	50.00	50.00	50.00	50.00	50.00	50.00	50.00	50.00	50.00	50.00	50.00
27	HER/7G-K.	Herring (Celtic Sea)	7a south of 52°30'N, 7g, 7h, 7j and 7k	99.88	0.12	99.88	0.12	99.88	0.12	99.88	0.12	99.88	0.12	99.88	0.12	99.88	0.12
28	HKE/2AC4-C	Hake (North Sea)	UK and Union waters 4; UK waters of 2a	60.67	39.33	57.11	42.89	53.56	46.44	49.29	50.71	46.45	53.55	46.45	53.55	46.45	53.55
29	HKE/571214	Hake (Western)	6 and 7, UK and international waters of 5b; international waters of 12 and 14	80.33	19.67	80.05	19.95	79.77	20.23	79.43	20.57	79.20	20.80	79.20	20.80	79.20	20.80
30	JAX/2A-14	Horse Mackerel (Western)	UK and Union waters of 4b; 6, 7a-c, e-k; 8a-b, d-e; UK and international waters of 2a and 5b; international waters of 12 and 14	90.61	9.39	90.61	9.39	90.61	9.39	90.61	9.39	90.61	9.39	90.61	9.39	90.61	9.39
31	JAX/4B7D	Horse Mackerel (Southern North Sea and Eastern Channel)	UK and Union waters of 4b, 4c and 7d	71.46	28.54	68.60	31.40	65.73	34.27	62.29	37.71	60.00	40.00	60.00	40.00	60.00	40.00
32	L/W/2AC4-C	Lemon Sole and Witch (North Sea)*	Union waters of 2a and 4	35.97	64.03	35.48	64.52	34.98	65.02	34.39	65.61	34.00	66.00	34.00	66.00	34.00	66.00
33	LEZ/07.	Megrims (7)	7	81.37	18.63	80.65	19.35	79.93	20.07	79.07	20.93	78.50	21.50	78.50	21.50	78.50	21.50
34	LEZ/2AC4-C	Megrims (North Sea)	UK and Union waters 4; UK waters of 2a	3.74	96.26	3.74	96.26	3.74	96.26	3.74	96.26	3.74	96.26	3.74	96.26	3.74	96.26
35	LEZ/56-14	Megrims (West of Scotland)	6; UK and international waters of 5b; international waters of 12 and 14	60.84	39.16	59.55	40.45	58.25	41.75	56.69	43.31	55.65	44.35	55.65	44.35	55.65	44.35
36	LIN/03A-C.	Ling (3a)	Union waters of 3a	92.65	7.35	92.65	7.35	92.65	7.35	92.65	7.35	92.65	7.35	92.65	7.35	92.65	7.35
37	LIN/04-C.	Ling (North Sea)	UK and Union waters of 4	21.22	78.78	20.92	79.08	20.61	79.39	20.24	79.76	20.00	80.00	20.00	80.00	20.00	80.00
38	LIN/6X14.	Ling (Western)	6, 7, 8, 9 and 10; international waters of 12 and 14	63.67	36.33	63.25	36.75	62.83	37.17	62.33	37.67	62.00	38.00	62.00	38.00	62.00	38.00
39	NEP/*07U16	Nephrops (Porcupine Bank)	Functional Unit 16 of ICES Subarea 7	85.32	14.68	85.32	14.68	85.32	14.68	85.32	14.68	85.32	14.68	85.32	14.68	85.32	14.68
40	NEP/07.	Nephrops (7)	7	61.68	38.32	60.76	39.24	59.84	40.16	58.74	41.26	58.00	42.00	58.00	42.00	58.00	42.00
41	NEP/2AC4-C	Nephrops (North Sea)	UK and Union waters 4; UK waters of 2a	13.38	86.62	13.38	86.62	13.38	86.62	13.38	86.62	13.38	86.62	13.38	86.62	13.38	86.62
42	NOP/2A3A4.	Norway Pout (North Sea)	3a; UK and Union waters and 4; UK waters of 2a	85.00	15.00	82.50	17.50	80.00	20.00	77.00	23.00	75.00	25.00	75.00	25.00	75.00	25.00
43	PLE/07A.	Plaice (Irish Sea)	7a	48.89	51.11	48.89	51.11	48.89	51.11	48.89	51.11	48.89	51.11	48.89	51.11	48.89	51.11
44	PLE/56-14	Plaice (West of Scotland)	6; UK and international waters of 5b; international waters of 12 and 14	39.23	60.77	39.23	60.77	39.23	60.77	39.23	60.77	39.23	60.77	39.23	60.77	39.23	60.77
45	PLE/7DE.	Plaice (English Channel)*	7d and 7e	70.36	29.64	70.27	29.73	70.18	29.82	70.07	29.93	70.00	30.00	70.00	30.00	70.00	30.00
46	PLE/7FG.	Plaice (7fg)	7f and 7g	74.86	25.14	74.58	25.42	74.30	25.70	73.96	26.04	73.74	26.26	73.74	26.26	73.74	26.26
47	PLE/7HJK.	Plaice (7hjk)	7h, 7j and 7k	84.25	15.75	83.71	16.29	83.17	16.83	82.52	17.48	82.09	17.91	82.09	17.91	82.09	17.91
48	POK/56-14	Saithe (West of Scotland)	6; UK and international waters of 5b, 12 and 14	62.32	37.68	58.99	41.01	55.66	44.34	51.66	48.34	49.00	51.00	49.00	51.00	49.00	51.00
49	POK/7/3411	Saithe (Celtic Sea)	7, 8, 9 and 10; Union waters of CECAF 34.1.1	84.86	15.14	84.90	15.10	84.93	15.07	84.97	15.03	85.00	15.00	85.00	15.00	85.00	15.00
50	POL/07.	Pollack (7)	7	78.03	21.97	77.27	22.73	76.51	23.49	75.61	24.39	75.00	25.00	75.00	25.00	75.00	25.00
51	POL/56-14	Pollack (West of Scotland)	6; UK and international waters of 5b; international waters of 12 and 14	63.38	36.62	63.38	36.62	63.38	36.62	63.38	36.62	63.38	36.62	63.38	36.62	63.38	36.62
52	PRA/2AC4-C	Northern Prawn (North Sea)	UK and Union waters 4; UK waters of 2a	77.99	22.01	77.99	22.01	77.99	22.01	77.99	22.01	77.99	22.01	77.99	22.01	77.99	22.01



53	RJE/7FG.	Small-eyed Ray (7fg)	7f and 7g	56.36	43.64	53.39	46.61	50.42	49.58	46.86	53.14	44.49	55.51	44.49	55.51
54	RIU/7DE.	Undulate Ray (English Channel)	7d and 7e	69.12	30.88	68.09	31.91	67.06	32.94	65.82	34.18	65.00	35.00	65.00	35.00
55	RNG/5B67-	Roundnose Grenadier (Western)	6 and 7; UK and international waters of 5b	95.16	4.84	95.16	4.84	95.16	4.84	95.16	4.84	95.16	4.84	95.16	4.84
56	RNG/8X14-	Roundnose Grenadier (8,9,10,12,14)	Union and international waters of 8, 9, 10, 12 and 14	99.71	0.29	99.71	0.29	99.71	0.29	99.71	0.29	99.71	0.29	99.71	0.29
57	SAN/2A3A4.	Sandeel (North Sea, All Banks)	Union waters of 2a, 3a and 4	97.26	2.74	97.14	2.86	97.03	2.97	96.89	3.11	96.80	3.20	96.80	3.20
58	SBR/678-	Red Seabream (Western)	6, 7 and 8	90.00	10.00	90.00	10.00	90.00	10.00	90.00	10.00	90.00	10.00	90.00	10.00
59	SOL/07A.	Sole (Irish Sea)	7a	77.15	22.86	77.03	22.97	76.92	23.08	76.79	23.21	76.70	23.30	76.70	23.30
60	SOL/07D.	Sole (Eastern Channel)	7d	80.31	19.69	80.23	19.77	80.15	19.85	80.06	19.94	80.00	20.00	80.00	20.00
61	SOL/07E.	Sole (Western Channel)	7e	38.97	61.03	38.60	61.40	38.24	61.76	37.79	62.21	37.50	62.50	37.50	62.50
62	SOL/24-C.	Sole (North Sea)	UK and Union waters 4; UK waters of 2a	88.09	11.91	86.81	13.19	85.54	14.46	84.02	15.98	83.00	17.00	83.00	17.00
63	SOL/56-14	Sole (West of Scotland)	6; UK and international waters of 5b; international waters of 12 and 14	80.00	20.00	80.00	20.00	80.00	20.00	80.00	20.00	80.00	20.00	80.00	20.00
64	SOL/7FG.	Sole (7fg)	7f and 7g	69.35	30.65	68.93	31.07	68.51	31.49	68.01	31.99	67.67	32.33	67.67	32.33
65	SOL/7HJK.	Sole (7hjk)	7h, 7j and 7k	83.33	16.67	83.33	16.67	83.33	16.67	83.33	16.67	83.33	16.67	83.33	16.67
66	SPR/2AC4-C	Sprat (North Sea)	UK and Union waters 4; UK waters of 2a	96.18	3.82	96.18	3.82	96.18	3.82	96.18	3.82	96.18	3.82	96.18	3.82
67	SPR/7DE.	Sprat (English Channel)	7d and 7e	28.60	71.40	25.45	74.55	22.30	77.70	18.52	81.48	16.00	84.00	16.00	84.00
68	SRX/07D.	Skates and Rays (Eastern Channel)	7d	84.51	15.49	84.44	15.56	84.36	15.64	84.27	15.73	84.21	15.79	84.21	15.79
69	SRX/2AC4-C	Skates and Rays (North Sea)	UK and Union waters 4; UK waters of 2a	32.73	67.27	32.29	67.71	31.86	68.14	31.35	68.65	31.00	69.00	31.00	69.00
70	SRX/67AKXD	Skates and Rays (Western)	UK and Union waters of 6a, 6b, 7a-c and 7e-k	71.06	28.94	70.54	29.46	70.02	29.98	69.40	30.60	68.99	31.01	68.99	31.01
71	T/B/2AC4-C	Turbot and Brill (North Sea)*	Union waters of 2a and 4	81.82	18.18	81.37	18.63	80.91	19.09	80.36	19.64	80.00	20.00	80.00	20.00
72	USK/04-C.	Tusk (North Sea)	UK and Union waters of 4	59.46	40.54	59.46	40.54	59.46	40.54	59.46	40.54	59.46	40.54	59.46	40.54
73	USK/567EL	Tusk (Western)	6 and 7; UK and international waters of 5	70.73	29.27	70.55	29.45	70.37	29.63	70.15	29.85	70.00	30.00	70.00	30.00
74	WHG/07A.	Whiting (Irish Sea)	7a	42.27	57.73	41.45	58.55	40.63	59.37	39.65	60.35	39.00	61.00	39.00	61.00
75	WHG/56-14	Whiting (West of Scotland)	6; UK and international waters of 5b; international waters of 12 and 14	37.53	62.47	36.67	63.33	35.81	64.19	34.78	65.22	34.09	65.91	34.09	65.91
76	WHG/7X7A-C	Whiting (Celtic Sea)*	7b, 7c, 7d, 7e, 7f, 7g, 7h, 7j and 7k	88.95	11.05	88.89	11.11	88.84	11.16	88.77	11.23	88.73	11.27	88.73	11.27

ANNEX FISH.2

2A. UK-EU-NO trilateral stocks

#	Code	Common Name	ICES Areas	Shares											
				2021		2022		2023		2024		2025		2026 onwards	
				EU	UK	EU	UK	EU	UK	EU	UK	EU	UK	EU	UK
77	COD/2A3AX4	Cod (North Sea)	4; UK waters of 2a; that part of 3a not covered by the Skagerrak and Kattegat	47.03	52.97	46.02	53.98	45.02	54.99	43.81	56.19	43.00	57.00	43.00	57.00
78	HAD/2AC4.	Haddock (North Sea)	4; UK waters of 2a	18.45	81.55	17.80	82.20	17.14	82.86	16.35	83.65	15.83	84.17	15.83	84.17
79	HER/2A47DX	Herring (North Sea bycatch)	4, 7d and Union waters of 2a	98.18	1.82	98.18	1.82	98.18	1.82	98.18	1.82	98.18	1.82	98.18	1.82
80	HER/4A8.	Herring (North Sea)	UK, Union and Norwegian waters of 4 north of 53° 30' N	71.33	28.67	70.42	29.58	69.50	30.50	68.41	31.59	67.68	32.32	67.68	32.32
81	HER/4CX87D	Herring (Southern North Sea and Eastern Channel)	4c, 7d excluding Blackwater	88.76	11.24	88.48	11.52	88.21	11.79	87.87	12.13	87.65	12.35	87.65	12.35
82	PLE/2A3AX4	Plaice (North Sea)	4; UK waters of 2a; that part of 3a not covered by the Skagerrak and the Kattegat	71.54	28.46	71.54	28.46	71.54	28.46	71.54	28.46	71.54	28.46	71.54	28.46
83	POK/2C3A4	Saithe (North Sea)	3a and 4; UK waters of 2a	77.71	22.29	76.78	23.22	75.85	24.15	74.74	25.26	74.00	26.00	74.00	26.00
84	WHG/2AC4.	Whiting (North Sea)	4; Union waters of 2a	34.78	65.22	32.71	67.29	30.63	69.37	28.13	71.87	26.47	73.53	26.47	73.53

2B. Coastal States Stocks

#	Code	Common Name	ICES Areas	Shares											
				2021		2022		2023		2024		2025		2026 onwards	
				EU	UK	EU	UK	EU	UK	EU	UK	EU	UK	EU	UK
85	MAC/2A34.	Mackerel (North Sea)	3a and 4; UK waters of 2a; Union waters of 3b, 3c and Subdivisions 22- 32	93.91	6.09	93.78	6.22	93.65	6.35	93.50	6.50	93.40	6.60	93.40	6.60
86	MAC/2CX14-	Mackerel (Western)	6, 7, 8a, 8b, 8d and 8e; UK and international waters of 5b; international waters of 2a, 12 and 14	95.15	64.85	34.06	65.94	32.98	67.02	31.67	68.33	30.80	69.20	30.80	69.20
87	WHB/1X14	Blue Whiting (Northern)	UK, Union and international waters of 1, 2, 3, 4, 5, 6, 7, 8a, 8b, 8d, 8e, 12 and 14	79.47	20.53	79.35	20.65	79.24	20.76	79.09	20.91	79.00	21.00	79.00	21.00

2C. ICCAT Stocks

#	Code	Common Name	Area	Shares	
				EU	UK
88	ALB/AN05N	Albacore (North Atlantic)	Atlantic Ocean, north of 5° N	98.48	1.52
89	BFT/AE45WM	Bluefin Tuna (Northeast Atlantic)	Atlantic Ocean, east of 45° W, and Mediterranean	99.75	0.25
90	BSH/AN05N	Blue Shark (North Atlantic)	Atlantic Ocean, north of 5° N	99.90	0.10

91	SWO/AND5N	Swordfish (North Atlantic)	Atlantic Ocean, north of 5° N	99.99	0.01
----	-----------	----------------------------	-------------------------------	-------	------

#### 2D. NAFO Stocks

#	Code	Common Name	Area	Shares	
				EU	UK
92	COD/N3M.	Cod (NAFO 3M)	NAFO 3M	83.66	16.34

#### 2E. Special Cases

#	Code	Common Name	ICES Areas	Shares	
				EU	UK
93	COD/1/2B.	Cod (Svalbard)	1 and 2b	75.00	25.00

#### 2F. Stocks that are only present in one Party's waters

#	Code	Common Name	ICES Areas	Shares	
				EU	UK
94	GHL/1/2INT	Greenland Halibut (International 1,2)	International waters of 1 and 2	100.00	0.00
95	GHL/2A-C46	Greenland Halibut (North Sea and West of Scotland)	6; UK and Union waters of 4; UK waters of 2a; UK and international waters of 5b	27.35	72.65
96	HER/06ACL	Herring (Clyde)	6 Clyde	0.00	100.00
97	HER/1/2-	Herring (ASH)	UK, Faroese, Norwegian and international waters of 1 and 2	70.00	30.00
98	LIN/05EI.	Ling (5)	UK and international waters of 5	81.48	18.52
99	LIN/1/2.	Ling (1,2)	UK and international waters of 1 and 2	77.78	22.22
100	NEP/5BC6.	Nephrops (West of Scotland)	6; UK and international waters of 5b	2.36	97.64
101	RED/51214D	Redfish [Deep Pelagic] (5,12,14)	UK and international waters of 5; international waters of 12 and 14	98.00	2.00
102	RED/51214S	Redfish [Shallow Pelagic] (5,12,14)	UK and international waters of 5; international waters of 12 and 14	98.00	2.00
103	SBR/10-	Red Seabream (Azores)	Union and international waters of 10	99.12	0.88
104	SRX/89-C.	Skates and Rays (8,9)	Union waters of 8 and 9	99.78	0.22
105	USK/1214EI	Tusk (1,2,14)	UK and international waters of 1, 2 and 14	71.43	28.57

9/00

**ANNEX FISH.3**

#	Stock Code	Common Name	ICES Areas
10 6	ANF/8ABDE.	Anglerfish (8)	8a, 8b, 8d and 8e
10 7	BLI/03A-	Blue Ling (3a)	Union waters of 3a
10 8	BSF/8910-	Black Scabbardfish (8,9,10)	8, 9 and 10
10 9	COD/03AN.	Cod (Skagerrak)	Skagerrak
11 0	HAD/03A.	Haddock (3a)	3a
11 1	HER/03A.	Herring (3a)	3a
11 2	HER/03A-BC	Herring (3a bycatch)	3a
11 3	HER/6AS7BC	Herring (West of Ireland)	6aS, 7b and 7c
11 4	HKE/03A.	Hake (3a)	3a
11 5	HKE/8ABDE.	Hake (8)	8a, 8b, 8d and 8e
11 6	JAX/08C.	Horse Mackerel (8c)	8c
11 7	LEZ/8ABDE.	Megrim (8)	8a, 8b, 8d and 8e
11 8	MAC/2A4A-N	Mackerel (Denmark allocation in Norwegian waters)	Norwegian waters of 2a and 4a
11 9	MAC/8C3411	Mackerel (Southern Component)	8c, 9 and 10; Union waters of CECAF 34.1.1
12 0	PLE/03AN.	Plaice (Skagerrak)	Skagerrak
12	SPR/03A.	Sprat (3a)	3a

1			
12 2	SRX/03A-C.	Skates and Rays (3a)	Union waters of 3a
12 3	USK/03A.	Tusk (3a)	3a
12 4	WHB/8C341 1	Blue Whiting (Southern Component)	8c, 9 and 10; Union waters of CECAF 34.1.1

#### **ANNEX FISH.4: PROTOCOL ON ACCESS TO WATERS**

The United Kingdom and the Union

AFFIRMING the sovereign rights and obligations of independent coastal States exercised by the Parties;

EMPHASISING that the right of each Party to grant vessels of the other Party access to fish in its waters is ordinarily to be exercised in annual consultations following the determination of TACs for a given year in annual consultations;

NOTING the social and economic benefits of a further period of stability, during which fishers would be permitted until 30 June 2026 to continue to access the waters of the other Party as before the entry into force of this Agreement;

HAVE AGREED as follows:

##### **Article 1**

An adjustment period is hereby established. The adjustment period shall last from 1 January 2021 until 30 June 2026.

##### **Article 2**

1. By derogation from Article FISH.8(1), (3), (4), (5), (6) and (7) [Access to waters] of Heading V [Fisheries], during the adjustment period each Party shall grant to vessels of the other Party full access to its waters to fish:

- (a) stocks listed in Annex FISH.1 and Annex FISH.2A, B and F at a level that is reasonably commensurate with the Parties respective shares of the fishing opportunities;
- (b) non quota stocks at a level that equates to the average tonnage fished by that Party in the waters of the other Party during the period 2012-2016;
- (c) for qualifying vessels to the zone in the waters of the Parties between six and twelve nautical miles from the baselines in ICES divisions 4c and 7d-g to the extent that each Party's qualifying vessels had access to that zone on 31 December 2020.

For the purposes of this point, "qualifying vessel" means a vessel of a Party, which fished in the zone mentioned in the previous sentence in at least four years between 2012 and 2016, or its direct replacement.

2. The Parties shall notify the other Party of any change in the level and conditions of access to waters that will apply from 1 July 2026.

3. Article 9[Compensatory measures in case of withdrawal or reduction of access] shall apply *mutatis mutandis* in relation to any change under paragraph 2 of this Article in respect of the period from 1 July 2026 to 31 December 2026.

## **ANNEX LAW-1: EXCHANGES OF DNA, FINGERPRINTS AND VEHICLE REGISTRATION DATA**

### **CHAPTER 0: General provisions**

#### **Article 1: Aim**

The aim of this Annex is to lay down the necessary data protection, administrative and technical provisions for the implementation of Title II [Exchanges of DNA, Fingerprints and vehicle registration data] of Part Three.

#### **Article 2: Technical specifications**

States shall observe common technical specifications in connection with all requests and answers related to searches and comparisons of DNA profiles, dactyloscopic data and vehicle registration data. These technical specifications are laid down in Chapters 1 to 3.

#### **Article 3: Communications network**

The electronic exchange of DNA data, dactyloscopic data and vehicle registration data between States shall take place using the Trans European Services for Telematics between Administrations (TESTA II) communications network and further developments thereof.

#### **Article 4: Availability of automated data exchange**

States shall take all necessary measures to ensure that automated searching or comparison of DNA data, dactyloscopic data and vehicle registration data is possible 24 hours a day and seven days a week. In the event of a technical fault, the States' national contact points shall immediately inform each other and shall agree on temporary alternative information exchange arrangements in accordance with the legal provisions applicable. Automated data exchange shall be re-established as quickly as possible.

#### **Article 5: Reference numbers for DNA data and dactyloscopic data**

The reference numbers referred to in Articles LAW.PRUM.7 [Establishment of domestic DNA analysis files] and LAW.PRUM.11 [Dactyloscopic data] shall consist of a combination of the following:

- (a) a code allowing the States, in the case of a match, to retrieve personal data and other information in their databases in order to supply it to one, several or all of the States in accordance with Article LAW.PRUM.14 [Supply of further personal data and other information];
- (b) a code to indicate the national origin of the DNA profile or dactyloscopic data; and
- (c) with respect to DNA data, a code to indicate the type of DNA profile.

#### **Article 6: Principles of DNA data exchange**

1. States shall use existing standards for DNA data exchange, such as the European Standard Set (ESS) or the Interpol Standard Set of Loci (ISSOL).

2. The transmission procedure, in the case of automated searching and comparison of DNA profiles, shall take place within a decentralised structure.
3. Appropriate measures shall be taken to ensure confidentiality and integrity of data being sent to other States, including their encryption.
4. States shall take the necessary measures to guarantee the integrity of the DNA profiles made available or sent for comparison to the other States and to ensure that those measures comply with international standards such as ISO 17025.
5. States shall use State codes in accordance with the ISO 3166-1 alpha-2 standard.

#### Article 7: Rules for requests and answers in connection with DNA data

1. A request for an automated search or comparison, as referred to in Articles LAW.PRUM.8 [Automated searching of DNA profiles] or LAW.PRUM.9 [Automated comparison of DNA profiles], shall include only the following information:
  - (a) the State code of the requesting State;
  - (b) the date, time and indication number of the request;
  - (c) DNA profiles and their reference numbers;
  - (d) the types of DNA profiles transmitted (unidentified DNA profiles or reference DNA profiles); and
  - (e) information required for controlling the database systems and quality control for the automatic search processes.
2. The answer (matching report) to the request referred to in paragraph 1 shall contain only the following information:
  - (a) an indication as to whether there were one or more matches (HITs) or no matches (No-HITs);
  - (b) the date, time and indication number of the request;
  - (c) the date, time and indication number of the answer;
  - (d) the State codes of the requesting and requested States;
  - (e) the reference numbers of the requesting and requested States;
  - (f) the type of DNA profiles transmitted (unidentified DNA profiles or reference DNA profiles);
  - (g) the requested and matching DNA profiles; and



(h) information required for controlling the database systems and quality control for the automatic search processes.

3. Automated notification of a match shall only be provided if the automated search or comparison has resulted in a match of a minimum number of loci. That minimum is set out in Chapter 1.

4. The States shall ensure that requests comply with declarations issued pursuant to Article LAW.PRUM.7(3) [Establishment of domestic DNA analysis files].

Article 8: Transmission procedure for automated searching of unidentified DNA profiles in accordance with Article LAW.PRUM.8 [Automated searching of DNA profiles]

1. If, in a search with an unidentified DNA profile, no match has been found in the national database or a match has been found with an unidentified DNA profile, the unidentified DNA profile may then be transmitted to all other States' databases and if, in a search with this unidentified DNA profile, matches are found with reference DNA profiles and/or unidentified DNA profiles in other States' databases, these matches shall be automatically communicated and the DNA reference data transmitted to the requesting State; if no matches can be found in other States' databases, it shall be automatically communicated to the requesting State.

2. If, in a search with an unidentified DNA profile, a match is found in other States' databases, each State concerned may insert a note to that effect in its national database.

Article 9: Transmission procedure for automated search of reference DNA profiles in accordance with Article LAW.PRUM.8 [Automated searching of DNA profiles]

If, in a search with a reference DNA profile, no match has been found in the national database with a reference DNA profile or a match has been found with an unidentified DNA profile, this reference DNA profile may then be transmitted to all other States' databases and if, in a search with this reference DNA profile, matches are found with reference DNA profiles and/or unidentified DNA profiles in other States' databases, these matches shall be automatically communicated and the DNA reference data transmitted to the requesting State; if no matches can be found in other States' databases, it shall be automatically communicated to the requesting State.

Article 10: Transmission procedure for automated comparison of unidentified DNA profiles in accordance with Article LAW.PRUM.9 [Automated comparison of DNA profiles]

1. If, in a comparison with unidentified DNA profiles, matches are found in other States' databases with reference DNA profiles and/or unidentified DNA profiles, these matches shall be automatically communicated and the DNA reference data transmitted to the requesting State.

2. If, in a comparison with unidentified DNA profiles, matches are found in other States' databases with unidentified DNA profiles or reference DNA profiles, each State concerned may insert a note to that effect in its national database.

#### Article 11: Principles for the exchange of dactyloscopic data

1. The digitalisation of dactyloscopic data and their transmission to the other States shall be carried out in accordance with the uniform data format specified in Chapter 2.
2. Each State shall ensure that the dactyloscopic data it transmits are of sufficient quality for a comparison by the automated fingerprint identification systems (AFIS).
3. The transmission procedure for the exchange of dactyloscopic data shall take place within a decentralised structure.
4. Appropriate measures shall be taken to ensure the confidentiality and integrity of dactyloscopic data being sent to other States, including their encryption.
5. The States shall use State codes in accordance with the ISO 3166-1 alpha-2 standard.

#### Article 12: Search capacities for dactyloscopic data

1. Each State shall ensure that its search requests do not exceed the search capacities specified by the requested State. The United Kingdom shall declare their maximum search capacities per day for dactyloscopic data of identified persons and for dactyloscopic data of persons not yet identified.
2. The maximum numbers of candidates accepted for verification per transmission are set out in Chapter 2.

#### Article 13: Rules for requests and answers in connection with dactyloscopic data

1. The requested State shall check the quality of the transmitted dactyloscopic data without delay by a fully automated procedure. Should the data be unsuitable for an automated comparison, the requested State shall inform the requesting State without delay.
2. The requested State shall conduct searches in the order in which requests are received. Requests shall be processed within 24 hours by a fully automated procedure. The requesting State may, if its domestic law so prescribes, ask for accelerated processing of its requests and the requested State shall conduct these searches without delay. If deadlines cannot be met for reasons of *force majeure*, the comparison shall be carried out without delay as soon as the impediments have been removed.

#### Article 14: Principles of automated searching of vehicle registration data

1. For automated searching of vehicle registration data States shall use a version of the European Vehicle and Driving Licence Information System (Eucaris) software application especially designed for the purposes of Article LAW.PRUM.15 [Automated searching of vehicle registration data], and amended versions of that software.
2. Automated searching of vehicle registration data shall take place within a decentralised structure.

3. The information exchanged via the Eucaris system shall be transmitted in encrypted form.
4. The data elements of the vehicle registration data to be exchanged are specified in Chapter 3.
5. In the implementation of Article LAW.PRUM.15 [Automated searching of vehicle registration data], States may give priority to searches related to combating serious crime.

#### Article 15: Costs

Each State shall bear the costs arising from the administration, use and maintenance of the Eucaris software application referred to in Article 14(1).

#### Article 16: Purpose

1. Processing of personal data by the receiving State shall be permitted solely for the purposes for which the data have been supplied in accordance with Title II [Exchanges of DNA, Fingerprints and vehicle registration data] of Part Three. Processing for other purposes shall be permitted solely with the prior authorisation of the State administering the file and subject only to the domestic law of the receiving State. Such authorisation may be granted provided that processing for such other purposes is permitted under the domestic law of the State administering the file.
2. Processing of data supplied pursuant to Articles LAW.PRUM.8 [Automated searching of DNA profiles], LAW.PRUM.9 [Automated comparison of DNA profiles] and LAW.PRUM.12 [Automated searching of dactyloscopic data] by the searching or comparing State shall be permitted solely in order to:
  - (a) establish whether the compared DNA profiles or dactyloscopic data match;
  - (b) prepare and submit a police or judicial request for legal assistance in compliance with domestic law if those data match;
  - (c) record within the meaning of Article 19 of this Chapter.
3. The State administering the file may process the data supplied to it in accordance with Articles LAW.PRUM.8 [Automated searching of DNA profiles], LAW.PRUM.9 [Automated comparison of DNA profiles] and LAW.PRUM.12 [Automated searching of dactyloscopic data] solely where this is necessary for the purposes of comparison, providing automated replies to searches or recording pursuant to Article 19 of this Chapter. The supplied data shall be deleted immediately following data comparison or automated replies to searches unless further processing is necessary for the purposes referred to in points (b) and (c) of paragraph 2 of this Article.
4. Data supplied in accordance with Article.LAW.PRUM.15 [Automated searching of vehicle registration data] may be used by the State administering the file solely where this is necessary for the purpose of providing automated replies to search procedures or recording pursuant to Article 19 of this Chapter. The data supplied shall be deleted immediately following automated replies to

searches unless further processing is necessary for recording pursuant to Article 19 of this Chapter. The Member State may use data received in a reply solely for the procedure for which the search was made.

#### Article 17: Accuracy, current relevance and storage time of data

1. The States shall ensure the accuracy and current relevance of personal data. The receiving State shall be notified without delay if it transpires ex officio, or from a notification by the data subject, that incorrect data or data which should not have been supplied have been supplied. The State(s) concerned shall be obliged to correct or delete the data. Moreover, personal data supplied shall be corrected if they are found to be incorrect. If the receiving body has reason to believe that the supplied data are incorrect or should be deleted, the supplying body shall be informed forthwith.

2. Data, the accuracy of which the data subject contests and the accuracy or inaccuracy of which cannot be established shall, in accordance with the domestic law of the States, be marked with a flag at the request of the data subject. If a flag exists, this may be removed subject to the domestic law of the States and only with the permission of the data subject or on the basis of a decision of the competent court or independent data protection authority.

3. Personal data supplied which should not have been supplied or received shall be deleted. Data which are lawfully supplied and received shall be deleted:

- (a) if they are not or no longer necessary for the purpose for which they were supplied; if personal data have been supplied without request, the receiving body shall immediately check if they are necessary for the purposes for which they were supplied;
- (b) following the expiry of the maximum period for keeping data laid down in the domestic law of the supplying State, where the supplying body informed the receiving body of that maximum period at the time of supplying the data.

4. Where there is reason to believe that deletion would prejudice the interests of the data subject, the data shall be blocked instead of being deleted in compliance with domestic law. Blocked data may be supplied or used solely for the purpose which prevented their deletion.

#### Article 18: Technical and organisational measures to ensure data protection and data security

1. The supplying and receiving bodies shall take steps to ensure that personal data is effectively protected against accidental or unauthorised destruction, accidental loss, unauthorised access, unauthorised or accidental alteration and unauthorised disclosure.

2. The features of the technical specification of the automated search procedure are regulated in the implementing measures as referred to in Article LAW.PRUM.17 [Implementing measures] which guarantee that:

- (a) state-of-the-art technical measures are taken to ensure data protection and data security, in particular data confidentiality and integrity;

- (b) encryption and authorisation procedures recognised by the competent authorities are used when having recourse to generally accessible networks; and
- (c) the admissibility of searches in accordance with paragraphs 2, 5 and 6 of Article 19 of this Chapter can be checked.

Article 19: Logging and recording: special rules governing automated and non-automated supply

1. Each State shall guarantee that every non-automated supply and every non-automated receipt of personal data by the body administering the file and by the searching body is logged in order to verify the admissibility of the supply. Logging shall contain the following information:

- (a) the reason for the supply;
- (b) the data supplied;
- (c) the date of the supply; and
- (d) the name or reference code of the searching body and of the body administering the file.

2. The following shall apply to automated searches for data based on Articles LAW.PRUM.8 [Automated searching of DNA profiles], LAW.PRUM.12 [Automated searching of dactyloscopic data] and LAW.PRUM.15 [Automated searching of vehicle registration data] and to automated comparison pursuant to Article LAW.PRUM.9 [Automated comparison of DNA profiles]:

- (a) only specially authorised officers of the national contact points may carry out automated searches or comparisons; the list of officers authorised to carry out automated searches or comparisons shall be made available upon request to the supervisory authorities referred to in paragraph 6 and to the other States;
- (b) each State shall ensure that each supply and receipt of personal data by the body administering the file and the searching body is recorded, including notification of whether or not a HIT exists; recording shall include the following information:
  - (i) the data supplied;
  - (ii) the date and exact time of the supply; and
  - (iii) the name or reference code of the searching body and of the body administering the file.

3. The searching body shall also record the reason for the search or supply as well as an identifier for the official who carried out the search and the official who ordered the search or supply.

4. The recording body shall immediately communicate the recorded data upon request to the competent data protection authorities of the relevant State at the latest within four weeks following receipt of the request; recorded data may be used solely for the following purposes:

- (a) monitoring data protection;
- (b) ensuring data security.

5. The recorded data shall be protected with suitable measures against inappropriate use and other forms of improper use and shall be kept for two years. After the conservation period, the recorded data shall be deleted immediately.

6. Responsibility for legal checks on the supply or receipt of personal data lies with the independent data protection authorities or, as appropriate, the judicial authorities of the respective States. Anyone can request those authorities to check the lawfulness of the processing of data in respect of their person in compliance with domestic law. Independently of such requests, those authorities and the bodies responsible for recording shall carry out random checks on the lawfulness of supply, based on the files involved.

7. The results of such checks shall be kept for inspection for 18 months by the independent data protection authorities. After that period, they shall be immediately deleted. Each data protection authority may be requested by the independent data protection authority of another State to exercise its powers in accordance with domestic law. The independent data protection authorities of the States shall perform the inspection tasks necessary for mutual cooperation, in particular by exchanging relevant information.

#### Article 20: Data subjects' rights to damages

Where a body of one State has supplied personal data under Title II [Exchanges of DNA, Fingerprints and vehicle registration data] of Part Three, the receiving body of the other State cannot use the inaccuracy of the data supplied as grounds to evade its liability vis-à-vis the injured party under domestic law. If damages are awarded against the receiving body because of its use of inaccurate transfer data, the body which supplied the data shall refund the amount paid in damages to the receiving body in full.

#### Article 21: Information requested by the States

The receiving State shall inform the supplying State on request of the processing of supplied data and the result obtained.

#### Article 22: Declarations and designations

1. The United Kingdom shall communicate its declarations pursuant to Article LAW.PRUM 7(3) [Establishment of domestic DNA analysis files], and Article 12(1) of this Chapter, as well as its designations pursuant to Articles LAW.PRUM 13(1) [National contact points], and LAW.PRUM 15(3) [Automated searching of vehicle registration data] to the Specialised Committee on Law Enforcement and Judicial Cooperation.

2. Factual information provided by the United Kingdom through these declarations and designations, and by Member States in accordance with Article LAW.PRUM.17(3) [Implementing measures], are included in the Manual as referred to in Article 18(2) of Decision 2008/616/JHA.

3. States may amend declarations and designations submitted in accordance with paragraph 1 at any time by means of a notification submitted to the Specialised Committee on Law Enforcement and Judicial Cooperation. The Specialised Committee on Law Enforcement and Judicial Cooperation shall forward any declarations received to the General Secretariat of the Council.

4. The General Secretariat of the Council shall communicate any changes in the Manual referred to in paragraph 2 to the Specialised Committee on Law Enforcement and Judicial Cooperation.

#### Article 23: Preparation of decisions as referred to in Article LAW.PRUM.18 [Ex ante evaluation]

1. The Council shall take a decision as referred to in Article LAW.PRUM.18 [Ex ante evaluation] on the basis of an evaluation report which shall be based on a questionnaire.

2. With respect to the automated data exchange in accordance with Title II [Exchanges of DNA, Fingerprints and vehicle registration data] of Part Three, the evaluation report shall also be based on an evaluation visit and a pilot run that shall be carried out if required when the United Kingdom has informed the Specialised Committee on Law Enforcement and Judicial Cooperation that they have implemented the obligations imposed on them under Title II [Exchanges of DNA, Fingerprints and vehicle registration data] of Part Three and submit the declarations provided for in Article 22 of this Chapter. Further details of the procedure are set out in Chapter 4 of this Annex.

#### Article 24: Statistics and reporting

1. An evaluation of the administrative, technical and financial application of the data exchange pursuant to Title II [Exchanges of DNA, Fingerprints and vehicle registration data] of Part Three shall be carried out on a regular basis. The evaluation shall be carried out with respect to the data categories for which data exchange has started among the States concerned. The evaluation shall be based on reports of the respective States.

2. Each State shall compile statistics on the results of the automated data exchange. In order to ensure comparability, the model for statistics will be compiled by the relevant Council Working Group. These statistics will be forwarded annually to the Specialised Committee on Law Enforcement and Judicial Cooperation.

3. In addition, States will be requested on a regular basis not to exceed once per year to provide further information on the administrative, technical and financial implementation of automated data exchange as needed to analyse and improve the process.

4. Statistics and reporting made by Member States in accordance with Decisions 2008/615/JHA and 2008/616/JHA shall apply in relation to this Article.

## CHAPTER 1: Exchange of DNA-data

### 1. DNA related forensic issues, matching rules and algorithms

#### 1.1. Properties of DNA-profiles

The DNA profile may contain 24 pairs of numbers representing the alleles of 24 loci which are also used in the DNA-procedures of Interpol. The names of those loci are provided in the following table:

VWA	TH01	D21S11	FGA	D8S1179	D3S1358	D18S51	Amelogenin
TPOX	CSF1P0	D13S317	D7S820	D5S818	D16S539	D2S1338	D19S433
Penta D	Penta E	FES	F13A1	F13B	SE33	CD4	GABA

The seven grey loci in the top row are both the present ESS and the ISSOL.

#### Inclusion Rules:

The DNA-profiles made available by the States for searching and comparison as well as the DNA-profiles sent out for searching and comparison shall contain at least six full designated<sup>147</sup> loci and may contain additional loci or blanks depending on their availability. The reference DNA profiles shall contain at least six of the seven ESS of loci. In order to raise the accuracy of matches, all available alleles shall be stored in the indexed DNA profile database and be used for searching and comparison. Each State should implement as soon as practically possible any new ESS of loci adopted by the EU.

Mixed profiles are not allowed, so that the allele values of each locus will consist of only two numbers, which may be the same in the case of homozygosity at a given locus.

Wild-cards and Micro-variants are to be dealt with using the following rules:

- Any non-numerical value except amelogenin contained in the profile (e.g. 'o', 'f', 'r', 'na', 'nr' or 'un') has to be automatically converted for the export to a wild card (\*) and searched against all,
- Numerical values '0', '1' or '99' contained in the profile have to be automatically converted for the export to a wild card (\*) and searched against all,
- If three alleles are provided for one locus the first allele will be accepted and the remaining two alleles have to be automatically converted for the export to a wild card (\*) and searched against all,

---

<sup>147</sup> 'Full designated' means the handling of rare allele values is included.



- When wild card values are provided for allele 1 or 2 then both permutations of the numerical value given for the locus will be searched (e.g. 12, \* could match against 12,14 or 9,12),
- Pentanucleotide (Penta D, Penta E and CD4) micro-variants will be matched according to the following:
  - x.1 = x, x.1, x.2
  - x.2 = x.1, x.2, x.3
  - x.3 = x.2, x.3, x.4
  - x.4 = x.3, x.4, x + 1,
- Tetranucleotide (the rest of the loci are tetranucleotides) micro-variants will be matched according to the following:
  - x.1 = x, x.1, x.2
  - x.2 = x.1, x.2, x.3
  - x.3 = x.2, x.3, x + 1.

## 1.2. Matching rules

The comparison of two DNA-profiles will be performed on the basis of the loci for which a pair of allele values is available in both DNA-profiles. At least six full designated loci (exclusive of amelogenin) must match between both DNA-profiles before a HIT response is provided.

A full match (Quality 1) is defined as a match, when all allele values of the compared loci commonly contained in the requesting and requested DNA-profiles are the same. A near match is defined as a match, when the value of only one of all the compared alleles is different in the two DNA profiles (Quality 2, 3 and 4). A near match is only accepted if there are at least six full designated matched loci in the two compared DNA profiles.

The reason for a near match may be:

- a human typing error at the point of entry of one of the DNA-profiles in the search request or the DNA-database,
- an allele-determination or allele-calling error during the generation procedure of the DNA-profile.

## 1.3. Reporting rules

Full matches, near matches and 'No-HITs' will all be reported.

The matching report will be sent to the requesting national contact point and will also be made available to the requested national contact point (to enable it to estimate the nature and number of possible follow-up requests for further available personal data and other information associated with the DNA-profile corresponding to the HIT in accordance with Article LAW.PRUM.14 [Supply of further personal data and other information]).

## 2. State code number table

In accordance with Title II [Exchanges of DNA, Fingerprints and vehicle registration data] of Part Three, ISO 3166-1 alpha-2 code are used for setting up the domain names and other configuration parameters required in the Prüm DNA data exchange applications over a closed network.

ISO 3166-1 alpha-2 codes are the following two-letter State codes:

State names	Code	State names	Code
Belgium	BE	Lithuania	LT
Bulgaria	BG	Luxemburg	LU
Czech Republic	CZ	Hungary	HU
Denmark	DK	Malta	MT
Germany	DE	Netherlands	NL
Estonia	EE	Austria	AT
Ireland	IE	Poland	PL
Greece	EL	Portugal	PT
Spain	ES	Romania	RO
France	FR	Slovakia	SK
Croatia	HR	Slovenia	SI
Italy	IT	Finland	FI
Cyprus	CY	Sweden	SE
Latvia	LV	United Kingdom	UK

## 3. Functional analysis

### 3.1. Availability of the system

Requests pursuant to Article LAW.PRUM.8 [Automated searching of DNA profiles] should reach the targeted database in the chronological order that each request was sent; responses should be dispatched to reach the requesting State within 15 minutes of the arrival of requests.

### 3.2. Second step

When a State receives a report of a match, its national contact point is responsible for comparing the values of the profile submitted as a question and the values of the profile(s) received as an answer to validate and check the evidential value of the profile. National contact points can contact each other directly for validation purposes.

Legal assistance procedures start after validation of an existing match between two profiles, on the basis of a 'full match' or a 'near match' obtained during the automated consultation phase.

## 4. DNA interface control document

### 4.1. Introduction

#### 4.1.1. Objectives

This Chapter defines the requirements for the exchange of DNA profile information between the DNA database systems of all States. The header fields are defined specifically for the Prüm DNA exchange; the data part is based on the DNA profile data part in the XML schema defined for the Interpol DNA exchange gateway.

Data are exchanged by Simple Mail Transfer Protocol (SMTP) and other state-of-the-art technologies, using a central relay mail server provided by the network provider. The XML file is transported as mail body.

#### 4.1.2. Scope

This ICD defines the content of the message (or 'mail') only. All network-specific and mail-specific topics are defined uniformly in order to allow a common technical base for the DNA data exchange.

This includes:

- the format of the subject field in the message to enable/allow for an automated processing of the messages,
- whether content encryption is necessary and if yes which methods should be chosen,
- the maximum length of messages.

#### 4.1.3. XML structure and principles

The XML message is structured into:

- the header part, which contains information about the transmission, and
- the data part, which contains profile specific information, as well as the profile itself.

The same XML schema shall be used for request and response.

For the purpose of complete checks of unidentified DNA profiles, as provided for in Article LAW.PRUM.9 [Automated comparison of DNA profiles], it shall be possible to send a batch of profiles in one message. A maximum number of profiles within one message must be defined. The number depends on the maximum allowed mail size and shall be defined after selection of the mail server.

XML example:

```
<?version="1.0" standalone="yes"?>
<PRUEMDNAx xmlns:msxsl="urn:schemas-microsoft-com:xslt"
xmlns:xsi="http://www.w3.org/2001/XMLSchema-instance">
<header>
(...)
</header>
<datas>
(...)
</datas>
[<datas> datas structure repeated, if multiple profiles sent by (...) a single SMTP message, only
allowed for Article LAW.PRUM.9 [Automated comparison of DNA profiles] cases
</datas>]
</PRUEMDNAx>
```

#### 4.2. XML structure definition

The following definitions are for documentation purposes and better readability; the real binding information is provided by an XML schema file (PRUEM DNA.xsd).

##### 4.2.1. Schema PRUEMDNAx

It contains the following fields:

Fields	Type	Description
header	PRUEM_header	Occurs: 1
datas	PRUEM_datas	Occurs: 1 ... 500

#### 4.2.2. Content of header structure

##### 4.2.2.1. PRUEM header

This is a structure describing the XML file header. It contains the following fields:

Fields	Type	Description
direction	PRUEM_header_dir	Direction of message flow
ref	String	Reference of the XML file
generator	String	Generator of XML file
schema_version	String	Version number of schema to use
requesting	PRUEM_header_info	Requesting State info
requested	PRUEM_header_info	Requested State info

##### 4.2.2.2. PRUEM\_header dir

Type of data contained in message, value can be:

Value	Description
R	Request
A	Answer

##### 4.2.2.3. PRUEM header info

Structure to describe State as well as message date/time. It contains the following fields:

Fields	Type	Description
source_isocode	String	ISO 3166-2 code of the requesting State
destination_isocode	String	ISO 3166-2 code of the requested State
request_id	String	unique Identifier for a request
date	Date	Date of creation of message

time	Time	Time of creation of message
------	------	-----------------------------

#### 4.2.3. Content of PRUEM Profile data

##### 4.2.3.1. PRUEM\_datas

This is a structure describing the XML profile data part. It contains the following fields:

Fields	Type	Description
reqtype	PRUEM request type	Type of request (Article LAW.PRUM.8 [Automated searching of DNA profiles] or LAW.PRUM.9 [Automated comparison of DNA profiles])
date	Date	Date profile stored
type	PRUEM_datas_type	Type of profile
result	PRUEM_datas_result	Result of request
agency	String	Name of corresponding unit responsible for the profile
profile_ident	String	Unique State profile ID
message	String	Error Message, if result = E
profile	IPSG_DNA_profile	If direction = A (Answer) AND result ≠ H (HIT) empty
match_id	String	In case of a HIT PROFILE_ID of the requesting profile
quality	PRUEM_hitquality_type	Quality of HIT
hitcount	Integer	Count of matched Alleles
rescount	Integer	Count of matched profiles. If direction = R (Request), then empty. If quality!=0 (the original requested profile), then empty.

##### 4.2.3.2. PRUEM\_request\_type

Type of data contained in message, value can be:

Value	Description
3	Requests pursuant to Article LAW.PRUM.8 [Automated searching of DNA profiles]
4	Requests pursuant to Article LAW.PRUM.9 [Automated comparison of DNA profiles]

#### 4.2.3.3. PRUEM\_hitquality\_type

Value	Description
0	Referring original requesting profile:  Case 'No-HIT': original requesting profile sent back only;  Case 'HIT': original requesting profile and matched profiles sent back.
1	Equal in all available alleles without wildcards
2	Equal in all available alleles with wildcards
3	HIT with Deviation (Microvariant)
4	HIT with mismatch

#### 4.2.3.4. PRUEM\_data\_type

Type of data contained in message, value can be:

Value	Description
P	Person profile
S	Stain

#### 4.2.3.5. PRUEM\_data\_result

Type of data contained in message, value can be:

Value	Description
-------	-------------

U	Undefined, If direction = R (request)
H	HIT
N	No-HIT
E	Error

#### 4.2.3.6. IPSTG\_DNA\_profile

Structure describing a DNA profile. It contains the following fields:

Fields	Type	Description
ess_issol	IPSTG_DNA_ISSOL	Group of loci corresponding to the ISSOL (standard group of Loci of Interpol)
additional_loci	IPSTG_DNA_additional_loci	Other loci
marker	String	Method used to generate of DNA
profile_id	String	Unique identifier for DNA profile

#### 4.2.3.7. IPSTG\_DNA\_ISSOL

Structure containing the loci of ISSOL (Standard Group of Interpol loci). It contains the following fields:

Fields	Type	Description
vwa	IPSTG_DNA_locus	Locus vwa
th01	IPSTG_DNA_locus	Locus th01
d21s11	IPSTG_DNA_locus	Locus d21s11
fga	IPSTG_DNA_locus	Locus fga
d8s1179	IPSTG_DNA_locus	Locus d8s1179
d3s1358	IPSTG_DNA_locus	Locus d3s1358
d18s51	IPSTG_DNA_locus	Locus d18s51



amelogenin	IPSG_DNA_locus	Locus amelogenin
------------	----------------	------------------

#### 4.2.3.8. IPSG\_DNA\_additional\_loci

Structure containing the other loci. It contains the following fields:

Fields	Type	Description
tpox	IPSG_DNA_locus	Locus tpox
csf1po	IPSG_DNA_locus	Locus csf1po
d13s317	IPSG_DNA_locus	Locus d13s317
d7s820	IPSG_DNA_locus	Locus d7s820
d5s818	IPSG_DNA_locus	Locus d5s818
d16s539	IPSG_DNA_locus	Locus d16s539
d2s1338	IPSG_DNA_locus	Locus d2s1338
d19s433	IPSG_DNA_locus	Locus d19s433
penta_d	IPSG_DNA_locus	Locus penta_d
penta_e	IPSG_DNA_locus	Locus penta_e
fes	IPSG_DNA_locus	Locus fes
f13a1	IPSG_DNA_locus	Locus f13a1
f13b	IPSG_DNA_locus	Locus f13b
se33	IPSG_DNA_locus	Locus se33
cd4	IPSG_DNA_locus	Locus cd4
gaba	IPSG_DNA_locus	Locus gaba

#### 4.2.3.9. IPSG\_DNA\_locus

Structure describing a locus. It contains the following fields:

Fields	Type	Description
low_allele	String	Lowest value of an allele
high_allele	String	Highest value of an allele

## 5. Application, security and communication architecture

### 5.1. Overview

In implementing applications for the DNA data exchange within the framework of Title II [Exchanges of DNA, Fingerprints and vehicle registration data] of Part Three, a common communication network shall be used, which will be logically closed among the States. In order to exploit this common communication infrastructure of sending requests and receiving replies in a more effective way, an asynchronous mechanism to convey DNA and dactyloscopic data requests in a wrapped SMTP e-mail message is adopted. In fulfilment of security concerns, the mechanism s/MIME as extension to the SMTP functionality will be used to establish a true end-to-end secure tunnel over the network.

The operational Trans European Services for Telematics between Administrations (TESTA) is used as the communication network for data exchange among the States. TESTA is under the responsibility of the European Commission. Taking into account that national DNA databases and the current national access points of TESTA may be located on different sites in the States, access to TESTA may be set up either by:

1. using the existing national access point or establishing a new national TESTA access point; or
2. setting up a secure local link from the site where the DNA database is located and managed by the competent national agency to the existing national TESTA access point.

The protocols and standards deployed in the implementation of Title II [Exchanges of DNA, Fingerprints and vehicle registration data] of Part Three applications comply with the open standards and meet the requirements imposed by national security policy makers of the States.

### 5.2. Upper Level Architecture

In the scope of Title II [Exchanges of DNA, Fingerprints and vehicle registration data] of Part Three, each State will make its DNA data available to be exchanged with and/or searched by other States in conformity with the standardised common data format. The architecture is based upon an any-to-any communication model. There exists neither a central computer server nor a centralised database to hold DNA profiles.

*Figure 1: Topology of DNA Data Exchange*

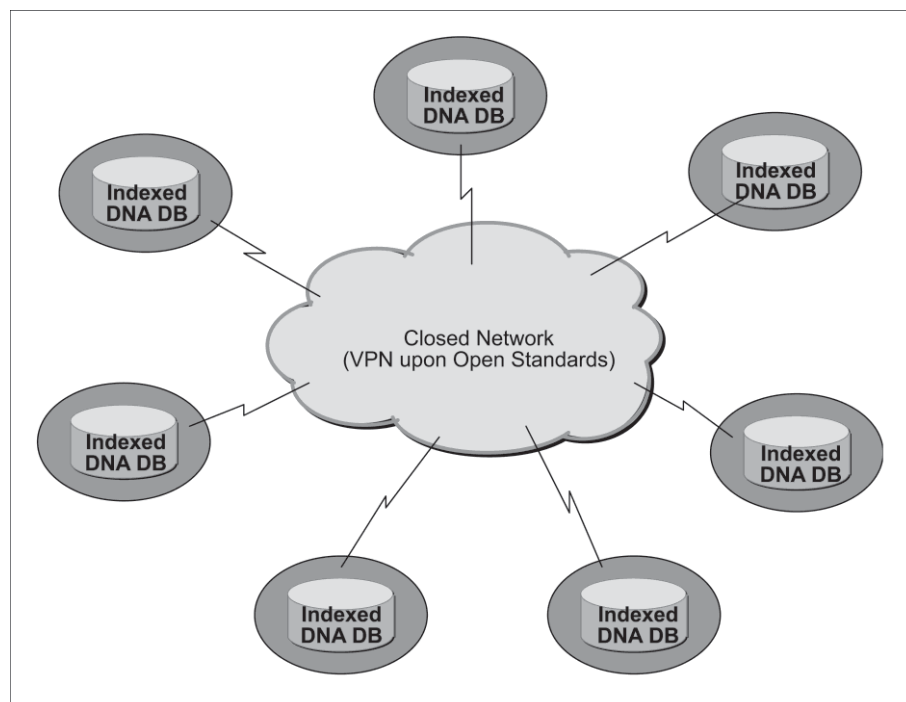

In addition to the fulfilment of domestic legal constraints at States' sites, each State may decide what kind of hardware and software should be deployed for the configuration at its site to comply with the requirements set out in Title II [Exchanges of DNA, Fingerprints and vehicle registration data] of Part Three.

### 5.3. Security Standards and Data Protection

Three levels of security concerns have been considered and implemented.

#### 5.3.1. *Data Level*

DNA profile data provided by each State shall have to be prepared in compliance with a common data protection standard, so that requesting States will receive an answer mainly to indicate HIT or No-HIT along with an identification number in case of a HIT, which does not contain any personal information. The further investigation after the notification of a HIT will be conducted at bilateral level pursuant to the existing domestic legal and organisational regulations of the respective States' sites.

#### 5.3.2. *Communication Level*

Messages containing DNA profile information (requesting and replying) will be encrypted by means of a state-of-the-art mechanism in conformity with open standards, such as s/MIME, before they are forwarded to the sites of other States.

#### 5.3.3. *Transmission Level*

All encrypted messages containing DNA profile information will be forwarded onto other States' sites through a virtual private tunnelling system administered by a trusted network provider at the

international level and the secure links to this tunnelling system under national responsibility. This virtual private tunnelling system does not have a connection point with the open Internet.

#### 5.4. Protocols and Standards to be used for encryption mechanism: s/MIME and related packages

The open standard s/MIME as extension to de facto e-mail standard SMTP will be deployed to encrypt messages containing DNA profile information. The protocol s/MIME (V3) allows signed receipts, security labels, and secure mailing lists and is layered on Cryptographic Message Syntax (CMS), an Internet Engineering Task Force (IETF) specification for cryptographic protected messages. It can be used to digitally sign, digest, authenticate or encrypt any form of digital data.

The underlying certificate used by the s/MIME mechanism has to be in compliance with X.509 standard. In order to ensure common standards and procedures with other Prüm applications, the processing rules for s/MIME encryption operations or to be applied under various Commercial Product of the Shelves (COTS) environments, are as follows:

- the sequence of the operations is: first encryption and then signing,
- the encryption algorithm AES (Advanced Encryption Standard) with 256 bit key length and RSA with 1024 bit key length shall be applied for symmetric and asymmetric encryption respectively,
- the hash algorithm SHA-1 shall be applied.

s/MIME functionality is built into the vast majority of modern e-mail software packages including Outlook, Mozilla Mail as well as Netscape Communicator 4.x and inter-operates among all major e-mail software packages.

Because of s/MIME's easy integration into national IT infrastructure at all States' sites, it is selected as a viable mechanism to implement the communication security level. For achieving the goal 'Proof of Concept' in a more efficient way and reducing costs the open standard JavaMail API is however chosen for prototyping DNA data exchange. JavaMail API provides simple encryption and decryption of e-mails using s/MIME and/or OpenPGP. The intent is to provide a single, easy-to-use API for e-mail clients that want to send and receive encrypted e-mail in either of the two most popular e-mail encryption formats. Therefore any state-of-the-art implementations to JavaMail API will suffice for the requirements set by Title II [Exchanges of DNA, Fingerprints and vehicle registration data] of Part Three, such as the product of Bouncy Castle JCE (Java Cryptographic Extension), which will be used to implement s/MIME for prototyping DNA data exchange among all States.

#### 5.5. Application Architecture

Each State will provide the other States with a set of standardised DNA profile data which are in conformity with the current common ICD. This can be done either by providing a logical view over individual national database or by establishing a physical exported database (indexed database).

The four main components: E-mail server/s/MIME, Application Server, Data Structure Area for fetching/feeding data and registering incoming/outgoing messages, and Match Engine implement the whole application logic in a product-independent way.

In order to provide all States with an easy integration of the components into their respective national sites, the specified common functionality has been implemented by means of open source components, which could be selected by each State depending on its national IT policy and regulations. Because of the independent features to be implemented to get access to indexed databases containing DNA profiles covered by Title II [Exchanges of DNA, Fingerprints and vehicle registration data] of Part Three, each State can freely select its hardware and software platform, including database and operating systems.

A prototype for the DNA Data Exchange has been developed and successfully tested over the existing common network. The version 1.0 has been deployed in the productive environment and is used for daily operations. States may use the jointly developed product but may also develop their own products. The common product components will be maintained, customised and further developed according to changing IT, forensic and/or functional police requirements.

*Figure 2: Overview Application Topology*

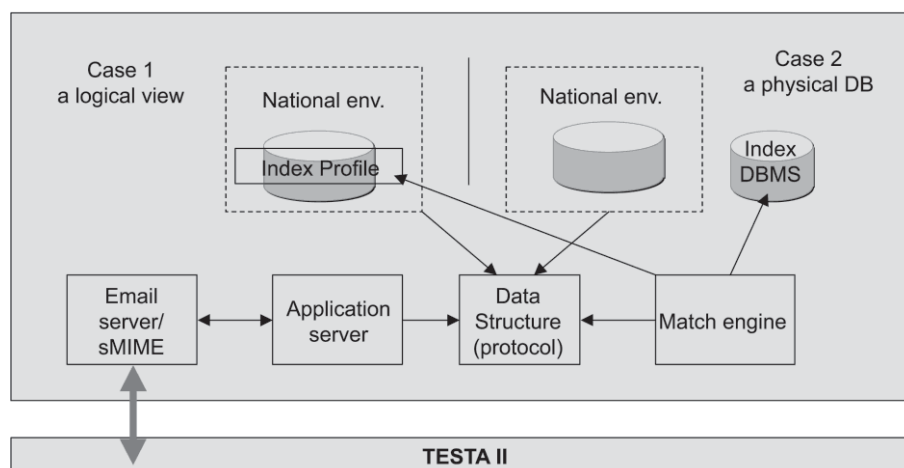

## 5.6. Protocols and Standards to be used for application architecture:

### 5.6.1. XML

The DNA data exchange will fully exploit XML-schema as attachment to SMTP e-mail messages. The eXtensible Markup Language (XML) is a W3C-recommended general-purpose markup language for creating special-purpose markup languages, capable of describing many different kinds of data. The description of the DNA profile suitable for exchange among all States has been done by means of XML and XML schema in the ICD document.

### 5.6.2. ODBC

Open DataBase Connectivity provides a standard software API method for accessing database management systems and making it independent of programming languages, database and operating systems. ODBC has, however, certain drawbacks. Administering a large number of client machines can involve a diversity of drivers and DLLs. This complexity can increase system administration overhead.

### 5.6.3. JDBC

Java DataBase Connectivity (JDBC) is an API for the Java programming language that defines how a client may access a database. In contrast to ODBC, JDBC does not require to use a certain set of local DLLs at the Desktop.

The business logic of processing DNA profile requests and replies at each States' site is described in the following diagram. Both requesting and replying flows interact with a neutral data area comprising different data pools with a common data structure.

*Figure 3: Overview Application Workflow at each State's site*

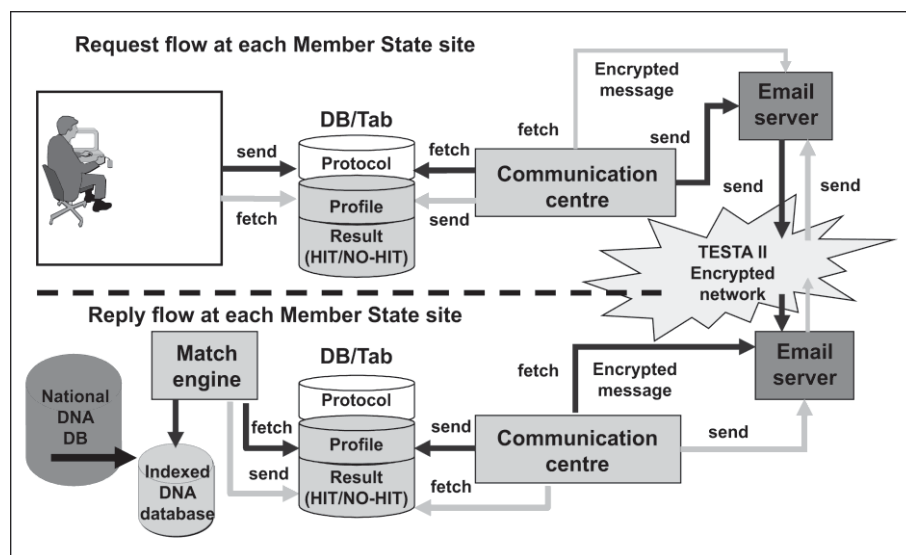

## 5.7. Communication Environment

### 5.7.1. Common Communication Network: TESTA and its follow-up infrastructure

The application DNA data exchange will exploit the e-mail, an asynchronous mechanism, to send requests and to receive replies among the States. As all States have at least one national access point to the TESTA network, the DNA data exchange will be deployed over the TESTA network. TESTA provides a number of added-value services through its e-mail relay. In addition to hosting TESTA specific e-mail boxes, the infrastructure can implement mail distribution lists and routing policies. This allows TESTA to be used as a clearing house for messages addressed to administrations connected to the EU wide Domains. Virus check mechanisms may also be put in place.

The TESTA e-mail relay is built on a high availability hardware platform located at the central TESTA application facilities and protected by firewall. The TESTA Domain Name Systems (DNS) will resolve resource locators to IP addresses and hide addressing issues from the user and from applications.

### 5.7.2. Security Concern

The concept of a Virtual Private Network (VPN) has been implemented within the framework of TESTA. Tag Switching Technology used to build this VPN will evolve to support Multi-Protocol Label Switching (MPLS) standard developed by the IETF.

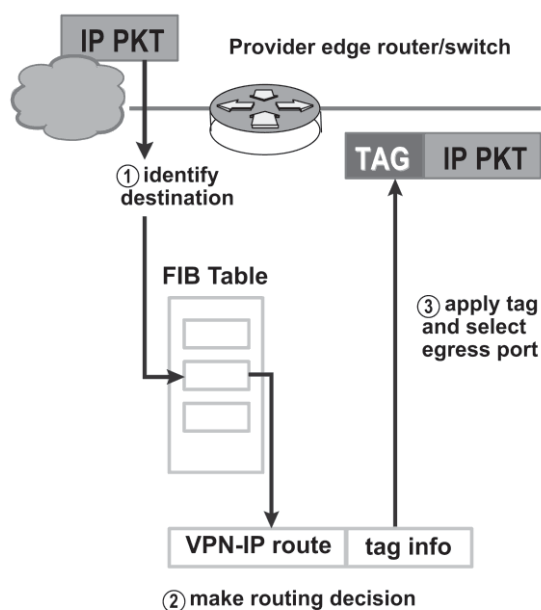

MPLS is an IETF standard technology that speeds up network traffic flow by avoiding packet analysis by intermediate routers (hops). This is done on the basis of so-called labels that are attached to packet by the edge routers of the backbone, on the basis of information stored in the forwarding information base (FIB). Labels are also used to implement VPNs.

MPLS combines the benefits of layer 3 routing with the advantages of layer 2 switching. Because IP addresses are not evaluated during transition through the backbone, MPLS does not impose any IP addressing limitations.

Furthermore, e-mail messages over the TESTA will be protected by s/MIME driven encryption mechanism. Without knowing the key and possessing the right certificate, nobody can decrypt messages over the network.

### 5.7.3. *Protocols and Standards to be used over the communication network*

#### 5.7.3.1. SMTP

SMTP is the de facto standard for e-mail transmission across the Internet. SMTP is a relatively simple, text-based protocol, where one or more recipients of a message are specified and then the message text is transferred. SMTP uses TCP port 25 upon the specification by the IETF. To determine the SMTP server for a given domain name, the MX (Mail eXchange) DNS (Domain Name Systems) record is used.

Since this protocol started as purely ASCII text-based it did not deal well with binary files. Standards such as MIME were developed to encode binary files for transfer through SMTP. Today, most SMTP servers support the 8BITMIME and s/MIME extension, permitting binary files to be transmitted almost as easily as plain text. The processing rules for s/MIME operations are described in the section s/MIME (see Section 5.4).

SMTP is a 'push' protocol that does not allow one to 'pull' messages from a remote server on demand. To do this a mail client shall use POP3 or IMAP. Within the framework of implementing DNA data exchange it is decided to use the protocol POP3.

#### 5.7.3.2. POP

Local e-mail clients use the Post Office Protocol version 3 (POP3), an application-layer Internet standard protocol, to retrieve e-mail from a remote server over a TCP/IP connection. By using the SMTP Submit profile of the SMTP protocol, e-mail clients send messages across the Internet or over a corporate network. MIME serves as the standard for attachments and non-ASCII text in e-mail. Although neither POP3 nor SMTP requires MIME-formatted e-mail, essentially Internet e-mail comes MIME-formatted, so POP clients must also understand and use MIME. The whole communication environment of Title II [Exchanges of DNA, Fingerprints and vehicle registration data] of Part Three will therefore include the components of POP.

#### 5.7.4. *Network Address Assignment*

##### Operative environment

A dedicated block half B class subnet has currently been allocated by the European IP registration authority (RIPE) to TESTA. The assignment of IP addresses to States is based upon a geographical schema in Europe. The data exchange among States within the framework of Title II [Exchanges of DNA, Fingerprints and vehicle registration data ] of Part Three is operated over a European wide logically closed IP network.

##### Testing Environment

In order to provide a smooth running environment for the daily operation among all connected States, it is necessary to establish a testing environment over the closed network for new States which prepare to join the operations. A sheet of parameters including IP addresses, network settings, e-mail domains as well as application user accounts has been specified and should be set up at the corresponding State's site. Moreover, a set of pseudo DNA profiles has been constructed for test purposes.

#### 5.7.5. *Configuration Parameters*

A secure e-mail system is set up using the eu-admin.net domain. That domain with the associated addresses will not be accessible from a location not on the TESTA EU wide domain, because the names are only known on the TESTA central DNS server, which is shielded from the Internet.

The mapping of these TESTA site addresses (host names) to their IP addresses is done by the TESTA DNS service. For each Local Domain, a Mail entry will be added to this TESTA central DNS server, relaying all e-mail messages sent to TESTA Local Domains to the TESTA central Mail Relay. That TESTA central Mail Relay will then forward them to the specific Local Domain e-mail server using the Local Domain e-mail addresses. By relaying the e-mail in this way, critical information contained in e-mails will only pass the Europe-wide closed network infrastructure and not the insecure Internet.

It is necessary to establish sub-domains (*bold italics*) at the sites of all States upon the following syntax:



‘application-type.State-code.pruem.testa.eu’, where:

‘State-code’ takes the value of one of the two letter-code State codes (i.e. AT, BE, etc.);

‘application-type’ takes one of the values: DNA,-FP and CAR.

By applying the above syntax, the sub domains for the States are shown in the following table:

**States’ sub domains syntax**

State	Sub Domains	Comments
BE	dna.be.pruem.testa.eu	
	fp.be.pruem.testa.eu	
	car.be.pruem.testa.eu	
	test.dna.be.pruem.testa.eu	
	test.fp.be.pruem.testa.eu	
	test.car.be.pruem.testa.eu	
BG	dna.bg.pruem.testa.eu	
	fp.bg.pruem.testa.eu	
	car.bg.pruem.testa.eu	
	test.dna.bg.pruem.testa.eu	
	test.fp.bg.pruem.testa.eu	
	test.car.bg.pruem.testa.eu	
CZ	dna.cz.pruem.testa.eu	
	fp.cz.pruem.testa.eu	
	car.cz.pruem.testa.eu	
	test.dna.cz.pruem.testa.eu	
	test.fp.cz.pruem.testa.eu	
	test.car.cz.pruem.testa.eu	

DK	dna.dk.pruem.testa.eu	
	fp.dk.pruem.testa.eu	
	car.dk.pruem.testa.eu	
	test.dna.dk.pruem.testa.eu	
	test.fp.dk.pruem.testa.eu	
	test.car.dk.pruem.testa.eu	
DE	dna.de.pruem.testa.eu	
	fp.de.pruem.testa.eu	
	car.de.pruem.testa.eu	
	test.dna.de.pruem.testa.eu	
	test.fp.de.pruem.testa.eu	
	test.car.de.pruem.testa.eu	
EE	dna.ee.pruem.testa.eu	
	fp.ee.pruem.testa.eu	
	car.ee.pruem.testa.eu	
	test.dna.ee.pruem.testa.eu	
	test.fp.ee.pruem.testa.eu	
	test.car.ee.pruem.testa.eu	
IE	dna.ie.pruem.testa.eu	
	fp.ie.pruem.testa.eu	
	car.ie.pruem.testa.eu	
	test.dna.ie.pruem.testa.eu	
	test.fp.ie.pruem.testa.eu	
	test.car.ie.pruem.testa.eu	

EL	dna.el.pruem.testa.eu	
	fp.el.pruem.testa.eu	
	car.el.pruem.testa.eu	
	test.dna.el.pruem.testa.eu	
	test.fp.el.pruem.testa.eu	
	test.car.el.pruem.testa.eu	
ES	dna.es.pruem.testa.eu	
	fp.es.pruem.testa.eu	
	car.es.pruem.testa.eu	
	test.dna.es.pruem.testa.eu	
	test.fp.es.pruem.testa.eu	
	test.car.es.pruem.testa.eu	
FR	dna.fr.pruem.testa.eu	
	fp.fr.pruem.testa.eu	
	car.fr.pruem.testa.eu	
	test.dna.fr.pruem.testa.eu	
	test.fp.fr.pruem.testa.eu	
	test.car.fr.pruem.testa.eu	
HR	dna.hr.pruem.testa.eu	
	fp.hr.pruem.testa.eu	
	car.hr.pruem.testa.eu	
	test.dna.hr.pruem.testa.eu	
	test.fp.hr.pruem.testa.eu	
	test.car.hr.pruem.testa.eu	

IT	dna.it.pruem.testa.eu	
	fp.it.pruem.testa.eu	
	car.it.pruem.testa.eu	
	test.dna.it.pruem.testa.eu	
	test.fp.it.pruem.testa.eu	
	test.car.it.pruem.testa.eu	
CY	dna.cy.pruem.testa.eu	
	fp.cy.pruem.testa.eu	
	car.cy.pruem.testa.eu	
	test.dna.cy.pruem.testa.eu	
	test.fp.cy.pruem.testa.eu	
	test.car.cy.pruem.testa.eu	
LV	dna.lv.pruem.testa.eu	
	fp.lv.pruem.testa.eu	
	car.lv.pruem.testa.eu	
	test.dna.lv.pruem.testa.eu	
	test.fp.lv.pruem.testa.eu	
	test.car.lv.pruem.testa.eu	
LT	dna.lt.pruem.testa.eu	
	fp.lt.pruem.testa.eu	
	car.lt.pruem.testa.eu	
	test.dna.lt.pruem.testa.eu	
	test.fp.lt.pruem.testa.eu	
	test.car.lt.pruem.testa.eu	

LU	dna.lu.pruem.testa.eu	
	fp.lu.pruem.testa.eu	
	car.lu.pruem.testa.eu	
	test.dna.lu.pruem.testa.eu	
	test.fp.lu.pruem.testa.eu	
	test.car.lu.pruem.testa.eu	
HU	dna.hu.pruem.testa.eu	
	fp.hu.pruem.testa.eu	
	car.hu.pruem.testa.eu	
	test.dna.hu.pruem.testa.eu	
	test.fp.hu.pruem.testa.eu	
	test.car.hu.pruem.testa.eu	
MT	dna.mt.pruem.testa.eu	
	fp.mt.pruem.testa.eu	
	car.mt.pruem.testa.eu	
	test.dna.mt.pruem.testa.eu	
	test.fp.mt.pruem.testa.eu	
	test.car.mt.pruem.testa.eu	
NL	dna.nl.pruem.nl.testa.eu	
	fp.nl.pruem.testa.eu	
	car.nl.pruem.testa.eu	
	test.dna.nl.pruem.testa.eu	
	test.fp.nl.pruem.testa.eu	
	test.car.nl.pruem.testa.eu	

AT	dna.at.pruem.testa.eu	
	fp.at.pruem.testa.eu	
	car.at.pruem.testa.eu	
	test.dna.at.pruem.testa.eu	
	test.fp.at.pruem.testa.eu	
	test.car.at.pruem.testa.eu	
PL	dna.pl.pruem.testa.eu	
	fp.pl.pruem.testa.eu	
	car.pl.pruem.testa.eu	
	test.dna.pl.pruem.testa.eu	
	test.fp.pl.pruem.testa.eu	
	test.car.pl.pruem.testa.eu	
PT	dna.pt.pruem.testa.eu	
	fp.pt.pruem.testa.eu	
	car.pt.pruem.testa.eu	
	test.dna.pt.pruem.testa.eu	
	test.fp.pt.pruem.testa.eu	
	test.car.pt.pruem.testa.eu	
RO	dna.ro.pruem.testa.eu	
	fp.ro.pruem.testa.eu	
	car.ro.pruem.testa.eu	
	test.dna.ro.pruem.testa.eu	
	test.fp.ro.pruem.testa.eu	
	test.car.ro.pruem.testa.eu	

SI	dna.si.pruem.testa.eu	
	fp.si.pruem.testa.eu	
	car.si.pruem.testa.eu	
	test.dna.si.pruem.testa.eu	
	test.fp.si.pruem.testa.eu	
	test.car.si.pruem.testa.eu	
SK	dna.sk.pruem.testa.eu	
	fp.sk.pruem.testa.eu	
	car.sk.pruem.testa.eu	
	test.dna.sk.pruem.testa.eu	
	test.fp.sk.pruem.testa.eu	
	test.car.sk.pruem.testa.eu	
FI	dna.fi.pruem.testa.eu	
	fp.fi.pruem.testa.eu	
	car.fi.pruem.testa.eu	
	test.dna.fi.pruem.testa.eu	
	test.fp.fi.pruem.testa.eu	
	test.car.fi.pruem.testa.eu	
SE	dna.se.pruem.testa.eu	
	fp.se.pruem.testa.eu	
	car.se.pruem.testa.eu	
	test.dna.se.pruem.testa.eu	
	test.fp.se.pruem.testa.eu	
	test.car.se.pruem.testa.eu	

UK	dna.uk.pruem.testa.eu	
	fp.uk.pruem.testa.eu	
	car.uk.pruem.testa.eu	
	test.dna.uk.pruem.testa.eu	
	test.fp.uk.pruem.testa.eu	
	test.car.uk.pruem.testa.eu	

## CHAPTER 2: Exchange of dactyloscopic data (interface control document)

The purpose of the following document interface Control Document is to define the requirements for the exchange of dactyloscopic information between the Automated Fingerprint Identification Systems (AFIS) of the States. It is based on the Interpol-Implementation of ANSI/NIST-ITL 1-2000 (INT-I, Version 4.22b).

This version shall cover all basic definitions for Logical Records Type-1, Type-2, Type-4, Type-9, Type-13 and Type-15 required for image- and minutiae-based dactyloscopic processing.

### 1. File Content Overview

A dactyloscopic file consists of several logical records. There are sixteen types of record specified in the original ANSI/NIST-ITL 1-2000 standard. Appropriate ASCII separation characters are used between each record and the fields and subfields within the records.

Only 6 record types are used to exchange information between the originating and the destination agency:

Type-1	→	Transaction information
Type-2	→	Alphanumeric persons/case data
Type-4	→	High resolution greyscale dactyloscopic images
Type-9	→	Minutiæ Record
Type-13	→	Variable resolution latent image record
Type-15	→	Variable resolution palmprint image record

#### 1.1. Type-1 — File header



This record contains routing information and information describing the structure of the rest of the file. This record type also defines the types of transaction which fall under the following broad categories:

1.2. Type-2 — Descriptive text

This record contains textual information of interest to the sending and receiving agencies.

1.3. Type-4 — High resolution greyscale image

This record is used to exchange high resolution greyscale (eight bit) dactyloscopic images sampled at 500 pixels/inch. The dactyloscopic images shall be compressed using the WSQ algorithm with a ratio of not more than 15:1. Other compression algorithms or uncompressed images shall not be used.

1.4. Type-9 — Minutiæ record

Type-9 records are used to exchange ridge characteristics or minutiæ data. Their purpose is partly to avoid unnecessary duplication of AFIS encoding processes and partly to allow the transmission of AFIS codes which contain less data than the corresponding images.

1.5. Type-13 — Variable-Resolution Latent Image Record

This record shall be used to exchange variable-resolution latent fingerprint and latent palmprint images together with textural alphanumerical information. The scanning resolution of the images shall be 500 pixels/inch with 256 grey-levels. If the quality of the latent image is sufficient it shall be compressed using WSQ-algorithm. If necessary the resolution of the images may be expanded to more than 500 pixels/inch and more than 256 grey-levels by mutual agreement. In that case, it is strongly recommended to use JPEG 2000 (see Appendix 7).

1.6. Variable-Resolution Palmprint Image Record

Type-15 tagged field image records shall be used to exchange variable-resolution palmprint images together with textural alphanumerical information. The scanning resolution of the images shall be 500 pixels/inch with 256 grey-levels. To minimise the amount of data, all palmprint images shall be compressed using WSQ-algorithm. If necessary the resolution of the images may be expanded to more than 500 pixels/inch and more than 256 grey-levels by mutual agreement. In that case, it is strongly recommended to use JPEG 2000 (see Appendix 7).

2. Record format

A transaction file shall consist of one or more logical records. For each logical record contained in the file, several information fields appropriate to that record type shall be present. Each information field may contain one or more basic single-valued information items. Taken together these items are used to convey different aspects of the data contained in that field. An information field may also consist of one or more information items grouped together and repeated multiple times within a field. Such a group of information items is known as a subfield. An information field may therefore consist of one or more subfields of information items.

2.1. Information separators

In the tagged-field logical records, mechanisms for delimiting information are implemented by use of four ASCII information separators. The delimited information may be items within a field or subfield, fields within a logical record, or multiple occurrences of subfields. These information separators are defined in the standard ANSI X3.4. These characters are used to separate and qualify information in a logical sense. Viewed in a hierarchical relationship, the File Separator 'FS' character is the most inclusive followed by the Group Separator 'GS', the Record Separator 'RS', and finally the Unit Separator 'US' characters. Table 1 lists these ASCII separators and a description of their use within this standard.

Information separators should be functionally viewed as an indication of the type data that follows. The 'US' character shall separate individual information items within a field or subfield. This is a signal that the next information item is a piece of data for that field or subfield. Multiple subfields within a field separated by the 'RS' character signals the start of the next group of repeated information item(s). The 'GS' separator character used between information fields signals the beginning of a new field preceding the field identifying number that shall appear. Similarly, the beginning of a new logical record shall be signalled by the appearance of the 'FS' character.

The four characters are only meaningful when used as separators of data items in the fields of the ASCII text records. There is no specific meaning attached to these characters occurring in binary image records and binary fields — they are just part of the exchanged data.

Normally, there should be no empty fields or information items and therefore only one separator character should appear between any two data items. The exception to this rule occurs for those instances where the data in fields or information items in a transaction are unavailable, missing, or optional, and the processing of the transaction is not dependent upon the presence of that particular data. In those instances, multiple and adjacent separator characters shall appear together rather than requiring the insertion of dummy data between separator characters.

For the definition of a field that consists of three information items, the following applies. If the information for the second information item is missing, then two adjacent 'US' information separator characters would occur between the first and third information items. If the second and third information items were both missing, then three separator characters should be used — two 'US' characters in addition to the terminating field or subfield separator character. In general, if one or more mandatory or optional information items are unavailable for a field or subfield, then the appropriate number of separator character should be inserted.

It is possible to have side-by-side combinations of two or more of the four available separator characters. When data are missing or unavailable for information items, subfields, or fields, there shall be one separator character less than the number of data items, subfields, or fields required.

Code	Type	Description	Hexadecimal Value	Decimal Value
US	Unit Separator	Separates information items	1F	31
RS	Record Separator	Separates subfields	1E	30

GS	Group Separator	Separates fields	1D	29
FS	File Separator	Separates logical records	1C	28

## 2.2. Record layout

For tagged-field logical records, each information field that is used shall be numbered in accordance with this standard. The format for each field shall consist of the logical record type number followed by a period '.', a field number followed by a colon ':', followed by the information appropriate to that field. The tagged-field number can be any one-to-nine digit number occurring between the period '.' and the colon ':'. It shall be interpreted as an unsigned integer field number. This implies that a field number of '2.123:' is equivalent to and shall be interpreted in the same manner as a field number of '2.000000123:'.

For purposes of illustration throughout this document, a three-digit number shall be used for enumerating the fields contained in each of the tagged-field logical records described herein. Field numbers will have the form of 'TT.xxx:' where the 'TT' represents the one- or two-character record type followed by a period. The next three characters comprise the appropriate field number followed by a colon. Descriptive ASCII information or the image data follows the colon.

Logical Type-1 and Type-2 records contain only ASCII textual data fields. The entire length of the record (including field numbers, colons, and separator characters) shall be recorded as the first ASCII field within each of these record types. The ASCII File Separator 'FS' control character (signifying the end of the logical record or transaction) shall follow the last byte of ASCII information and shall be included in the length of the record.

In contrast to the tagged-field concept, the Type-4 record contains only binary data recorded as ordered fixed-length binary fields. The entire length of the record shall be recorded in the first four-byte binary field of each record. For this binary record, neither the record number with its period, nor the field identifier number and its following colon, shall be recorded. Furthermore, as all the field lengths of this record is either fixed or specified, none of the four separator characters ('US', 'RS', 'GS', or 'FS') shall be interpreted as anything other than binary data. For the binary record, the 'FS' character shall not be used as a record separator or transaction terminating character.

## 3. Type-1 Logical Record: the File Header

This record describes the structure of the file, the type of the file, and other important information. The character set used for Type-1 fields shall contain only the 7-bit ANSI code for information interchange.

### 3.1. Fields for Type-1 Logical Record

#### 3.1.1. Field 1.001: Logical Record Length (LEN)

This field contains the total count of the number of bytes in the whole Type-1 logical record. The field begins with '1.001:', followed by the total length of the record including every character of every field and the information separators.

### 3.1.2. *Field 1.002: Version Number (VER)*

To ensure that users know which version of the ANSI/NIST standard is being used, this four byte field specifies the version number of the standard being implemented by the software or system creating the file. The first two bytes specify the major version reference number, the second two the minor revision number. For example, the original 1986 Standard would be considered the first version and designated '0100' while the present ANSI/NIST-ITL 1-2000 standard is '0300'.

### 3.1.3. *Field 1.003: File Content (CNT)*

This field lists each of the records in the file by record type and the order in which the records appear in the logical file. It consists of one or more subfields, each of which in turn contains two information items describing a single logical record found in the current file. The subfields are entered in the same order in which the records are recorded and transmitted.

The first information item in the first subfield is '1', to refer to this Type-1 record. It is followed by a second information item which contains the number of other records contained in the file. This number is also equal to the count of the remaining subfields of field 1.003.

Each of the remaining subfields is associated with one record within the file, and the sequence of subfields corresponds to the sequence of records. Each subfield contains two items of information. The first is to identify the Type of the record. The second is the record's IDC. The 'US' character shall be used to separate the two information items.

### 3.1.4. *Field 1.004: Type of Transaction (TOT)*

This field contains a three letter mnemonic designating the type of the transaction. These codes may be different from those used by other implementations of the ANSI/NIST standard.

CPS: Criminal Print-to-Print Search. This transaction is a request for a search of a record relating to a criminal offence against a prints database. The person's prints shall be included as WSQ-compressed images in the file.

In case of a No-HIT, the following logical records will be returned:

- 1 Type-1 Record,
- 1 Type-2 Record.

In case of a HIT, the following logical records will be returned:

- 1 Type-1 Record,
- 1 Type-2 Record,
- 1-14 Type-4 Record.

The CPS TOT is summarised in Table A.6.1 (Appendix 6).

**PMS: Print-to-Latent Search.** This transaction is used when a set of prints is searched against an Unidentified Latent database. The response will contain the HIT/No-HIT decision of the destination AFIS search. If multiple unidentified latents exist, multiple SRE transactions will be returned, with one latent per transaction. The person's prints shall be included as WSQ-compressed images in the file.

In case of a No-HIT, the following logical records will be returned:

- 1 Type-1 Record,
- 1 Type-2 Record.

In case of a HIT, the following logical records will be returned:

- 1 Type-1 Record,
- 1 Type-2 Record,
- 1 Type-13 Record.

The PMS TOT is summarised in Table A.6.1 (Appendix 6).

**MPS: Latent-to-Print Search.** This transaction is used when a latent is to be searched against a Prints database. The latent minutiae information and the image (WSQ-compressed) shall be included in the file.

In case of a No-HIT, the following logical records will be returned:

- 1 Type-1 Record,
- 1 Type-2 Record.

In case of a HIT, the following logical records will be returned:

- 1 Type-1 Record,
- 1 Type-2 Record,
- 1 Type-4 or Type-15 Record.

The MPS TOT is summarised in Table A.6.4 (Appendix 6).

**MMS: Latent-to-Latent Search.** In this transaction the file contains a latent which is to be searched against an Unidentified Latent database in order to establish links between various scenes of crime. The latent minutiae information and the image (WSQ-compressed) must be included in the file.

In case of a No-HIT, the following logical records will be returned:

- 1 Type-1 Record,

- 1 Type-2 Record.

In case of a HIT, the following logical records will be returned:

- 1 Type-1 Record,
- 1 Type-2 Record,
- 1 Type-13 Record.

The MMS TOT is summarised in Table A.6.4 (Appendix 6).

SRE: This transaction is returned by the destination agency in response to dactyloscopic submissions. The response will contain the HIT/No-HIT decision of the destination AFIS search. If multiple candidates exist, multiple SRE transactions will be returned, with one candidate per transaction.

The SRE TOT is summarised in Table A.6.2 (Appendix 6).

ERR: This transaction is returned by the destination AFIS to indicate a transaction error. It includes a message field (ERM) indicating the error detected. The following logical records will be returned:

- 1 Type-1 Record,
- 1 Type-2 Record.

The ERR TOT is summarised in Table A.6.3 (Appendix 6).

Transaction Type	Logical Record Type					
	1	2	4	9	13	15
CPS	M	M	M	—	—	—
SRE	M	M	C	— (C in case of latent HITs)	C	C
MPS	M	M	—	M (1*)	M	—
MMS	M	M	—	M (1*)	M	—
PMS	M	M	M*	—	—	M*
ERR	M	M	—	—	—	—

Key:

M	=	Mandatory,
M*	=	Only one of both record-types may be included,
O	=	Optional,
C	=	Conditional on whether data is available,
—	=	Not allowed,
1*	=	Conditional depending on legacy systems.

### 3.1.5. *Field 1.005: Date of Transaction (DAT)*

This field indicates the date on which the transaction was initiated and shall conform to the ISO standard notation of: YYYYMMDD

where YYYY is the year, MM is the month and DD is the day of the month. Leading zeros are used for single figure numbers. For example, '19931004' represents 4 October 1993.

### 3.1.6. *Field 1.006: Priority (PRY)*

This optional field defines the priority, on a level of 1 to 9, of the request. '1' is the highest priority and '9' the lowest. Priority '1' transactions shall be processed immediately.

### 3.1.7. *Field 1.007: Destination Agency Identifier (DAI)*

This field specifies the destination agency for the transaction.

It consists of two information items in the following format: CC/agency.

The first information item contains the Country Code, defined in ISO 3166, two alpha-numeric characters long. The second item, *agency*, is a free text identification of the agency, up to a maximum of 32 alpha-numeric characters.

### 3.1.8. *Field 1.008: Originating Agency Identifier (ORI)*

This field specifies the file originator and has the same format as the DAI (Field 1.007).

### 3.1.9. *Field 1.009: Transaction Control Number (TCN)*

This is a control number for reference purposes. It should be generated by the computer and have the following format: YYSSSSSSSA

where YY is the year of the transaction, SSSSSSSS is an eight-digit serial number, and A is a check character generated by following the procedure given in Appendix 2.

Where a TCN is not available, the field, YYSSSSSSSS, is filled with zeros and the check character generated as above.

#### *3.1.10. Field 1.010: Transaction Control Response (TCR)*

Where a request was sent out, to which this is the response, this optional field will contain the transaction control number of the request message. It therefore has the same format as TCN (Field 1.009).

#### *3.1.11. Field 1.011: Native Scanning Resolution (NSR)*

This field specifies the normal scanning resolution of the system supported by the originator of the transaction. The resolution is specified as two numeric digits followed by the decimal point and then two more digits.

For all transactions pursuant to Articles LAW.PRUM.11 [Dactyloscopic data] and LAW.PRUM.12 [Automated searching of dactyloscopic data] the sampling rate shall be 500 pixels/inch or 19,68 pixels/mm.

#### *3.1.12. Field 1.012: Nominal Transmitting Resolution (NTR)*

This five-byte field specifies the nominal transmitting resolution for the images being transmitted. The resolution is expressed in pixels/mm in the same format as NSR (Field 1.011).

#### *3.1.13. Field 1.013: Domain name (DOM)*

This mandatory field identifies the domain name for the user-defined Type-2 logical record implementation. It consists of two information items and shall be 'INT-I{{US}}4.22{{GS}}'.

#### *3.1.14. Field 1.014: Greenwich mean time (GMT)*

This mandatory field provides a mechanism for expressing the date and time in terms of universal Greenwich Mean Time (GMT) units. If used, the GMT field contains the universal date that will be in addition to the local date contained in Field 1.005 (DAT). Use of the GMT field eliminates local time inconsistencies encountered when a transaction and its response are transmitted between two places separated by several time zones. The GMT provides a universal date and 24-hour clock time independent of time zones. It is represented as 'CCYYMMDDHHMMSSZ', a 15-character string that is the concatenation of the date with the GMT and concludes with a 'Z'. The 'CCYY' characters shall represent the year of the transaction, the 'MM' characters shall be the tens and units values of the month, and the 'DD' characters shall be the tens and units values of the day of the month, the 'HH' characters represent the hour, the 'MM' the minute, and the 'SS' represents the second. The complete date shall not exceed the current date.

### **4. Type-2 Logical Record: Descriptive Text**

The structure of most of this record is not defined by the original ANSI/NIST standard. The record contains information of specific interest to the agencies sending or receiving the file. To ensure that communicating dactyloscopic systems are compatible, it is required that only the fields listed below are contained within the record. This document specifies which fields are mandatory and which optional, and also defines the structure of the individual fields.



#### 4.1. Fields for Type-2 Logical Record

##### 4.1.1. *Field 2.001: Logical Record Length (LEN)*

This mandatory field contains the length of this Type-2 record, and specifies the total number of bytes including every character of every field contained in the record and the information separators.

##### 4.1.2. *Field 2.002: Image Designation Character (IDC)*

The IDC contained in this mandatory field is an ASCII representation of the IDC as defined in the File Content field (CNT) of the Type-1 record (Field 1.003).

##### 4.1.3. *Field 2.003: System Information (SYS)*

This field is mandatory and contains four bytes which indicate which version of the INT-I this particular Type-2 record complies with.

The first two bytes specify the major version number, the second two the minor revision number. For example, this implementation is based on INT-I version 4 revision 22 and would be represented as '0422'.

##### 4.1.4. *Field 2.007: Case Number (CNO)*

This is a number assigned by the local dactyloscopic bureau to a collection of latents found at a scene-of-crime. The following format is adopted: CC/number

where CC is the Interpol Country Code, two alpha-numeric characters in length, and the number complies with the appropriate local guidelines and may be up to 32 alpha-numeric characters long.

This field allows the system to identify latents associated with a particular crime.

##### 4.1.5. *Field 2.008: Sequence Number (SQN)*

This specifies each sequence of latents within a case. It can be up to four numeric characters long. A sequence is a latent or series of latents which are grouped together for the purposes of filing and/or searching. This definition implies that even single latents will still have to be assigned a sequence number.

This field together with MID (Field 2.009) may be included to identify a particular latent within a sequence.

##### 4.1.6. *Field 2.009: Latent Identifier (MID)*

This specifies the individual latent within a sequence. The value is a single letter or two letters, with 'A' assigned to the first latent, 'B' to the second, and so on up to a limit of 'ZZ'. This field is used analogue to the latent sequence number discussed in the description for SQN (Field 2.008).

##### 4.1.7. *Field 2.010: Criminal Reference Number (CRN)*

This is a unique reference number assigned by a national agency to an individual who is charged for the first time with committing an offence. Within one country no individual ever has more than one CRN, or shares it with any other individual. However, the same individual may have Criminal Reference Numbers in several countries, which will be distinguishable by means of the country code.

The following format is adopted for CRN field: CC/number

where CC is the Country Code, defined in ISO 3166, two alpha-numeric characters in length, and the number complies with the appropriate national guidelines of the issuing agency, and may be up to 32 alpha-numeric characters long.

For transactions pursuant to Articles LAW.PRUM.11 [Dactyloscopic data ]and LAW.PRUM.12 [Automated searching of dactyloscopic data] this field will be used for the national criminal reference number of the originating agency which is linked to the images in Type-4 or Type-15 Records.

*4.1.8. Field 2.012: Miscellaneous Identification Number (MN1)*

This fields contains the CRN (Field 2.010) transmitted by a CPS or PMS transaction without the leading country code.

*4.1.9. Field 2.013: Miscellaneous Identification Number (MN2)*

This fields contains the CNO (Field 2.007) transmitted by an MPS or MMS transaction without the leading country code.

*4.1.10. Field 2.014: Miscellaneous Identification Number (MN3)*

This fields contains the SQN (Field 2.008) transmitted by an MPS or MMS transaction.

*4.1.11. Field 2.015: Miscellaneous Identification Number (MN4)*

This fields contains the MID (Field 2.009) transmitted by an MPS or MMS transaction.

*4.1.12. Field 2.063: Additional Information (INF)*

In case of an SRE transaction to a PMS request this field gives information about the finger which caused the possible HIT. The format of the field is:

*NN* where *NN* is the finger position code defined in Table 5, two digits in length.

In all other cases the field is optional. It consists of up to 32 alpha-numeric characters and may give additional information about the request.

*4.1.13. Field 2.064: Respondents List (RLS)*

This field contains at least two subfields. The first subfield describes the type of search that has been carried out, using the three-letter mnemonics which specify the transaction type in TOT (Field 1.004). The second subfield contains a single character. An 'I' shall be used to indicate that a HIT has been found and an 'N' shall be used to indicate that no matching cases have been found (No-HIT).

The third subfield contains the sequence identifier for the candidate result and the total number of candidates separated by a slash. Multiple messages will be returned if multiple candidates exist.

In case of a possible HIT the fourth subfield shall contain the score up to six digits long. If the HIT has been verified the value of this subfield is defined as '999999'.

Example: 'CPS{{RS}}I{{RS}}001/001{{RS}}999999{{GS}}'

If the remote AFIS does not assign scores, then a score of zero should be used at the appropriate point.

#### 4.1.14. Field 2.074: Status/Error Message Field (ERM)

This field contains error messages resulting from transactions, which will be sent back to the requester as part of an Error Transaction.

Numeric code (1-3)	Meaning (5-128)
003	ERROR: UNAUTHORISED ACCESS
101	Mandatory field missing
102	Invalid record type
103	Undefined field
104	Exceed the maximum occurrence
105	Invalid number of subfields
106	Field length too short
107	Field length too long
108	Field is not a number as expected
109	Field number value too small
110	Field number value too big
111	Invalid character
112	Invalid date
115	Invalid item value

116	Invalid type of transaction
117	Invalid record data
201	ERROR: INVALID TCN
501	ERROR: INSUFFICIENT FINGERPRINT QUALITY
502	ERROR: MISSING FINGERPRINTS
503	ERROR: FINGERPRINT SEQUENCE CHECK FAILED
999	ERROR: ANY OTHER ERROR. FOR FURTHER DETAILS CALL DESTINATION AGENCY.

Error messages in the range between 100 and 199:

These error messages are related to the validation of the ANSI/NIST records and defined as:

<error\_code 1>: IDC <idc\_number 1> FIELD <field\_id 1> <dynamic text 1> LF

<error\_code 2>: IDC <idc\_number 2> FIELD <field\_id 2> <dynamic text 2>...

where

- error\_code is a code uniquely related to a specific reason (see Table 3),
- field\_id is the ANSI/NIST field number of the incorrect field (e.g. 1.001, 2.001, ...) in the format <record\_type>.<field\_id>.<sub\_field\_id>,
- dynamic text is a more detailed dynamic description of the error,
- LF is a Line Feed separating errors if more than one error is encountered,
- for type-1 record the ICD is defined as '-1'.

Example:

201: IDC - 1 FIELD 1.009 WRONG CONTROL CHARACTER {{LF}} 115: IDC 0 FIELD 2.003 INVALID SYSTEM INFORMATION

This field is mandatory for error transactions.

#### 4.1.15. Field 2.320: Expected Number of Candidates (ENC)

This field contains the maximum number of candidates for verification expected by the requesting agency. The value of ENC shall not exceed the values defined in Table 11.

## 5. Type-4 Logical Record: High Resolution GreyScale Image

It should be noted that Type-4 records are binary rather than ASCII in nature. Therefore each field is assigned a specific position within the record, which implies that all fields are mandatory.

The standard allows both image size and resolution to be specified within the record. It requires Type-4 Logical Records to contain dactyloscopic image data that are being transmitted at a nominal pixel density of 500 to 520 pixels per inch. The preferred rate for new designs is at a pixel density of 500 pixels per inch or 19,68 pixels per mm. 500 pixels per inch is the density specified by the INT-I, except that similar systems may communicate with each other at a non-preferred rate, within the limits of 500 to 520 pixels per inch.

### 5.1. Fields for Type-4 Logical Record

#### 5.1.1. Field 4.001: Logical Record Length (LEN)

This four-byte field contains the length of this Type-4 record, and specifies the total number of bytes including every byte of every field contained in the record.

#### 5.1.2. Field 4.002: Image Designation Character (IDC)

This is the one-byte binary representation of the IDC number given in the header file.

#### 5.1.3. Field 4.003: Impression Type (IMP)

The impression type is a single-byte field occupying the sixth byte of the record.

Code	Description
0	Live-scan of plain fingerprint
1	Live-scan of rolled fingerprint
2	Non-live scan impression of plain fingerprint captured from paper
3	Non-live scan impression of rolled fingerprint captured from paper
4	Latent impression captured directly
5	Latent tracing
6	Latent photo
7	Latent lift
8	Swipe

9	Unknown
---	---------

#### 5.1.4. Field 4.004: Finger Position (FGP)

This fixed-length field of six bytes occupies the seventh through twelfth byte positions of a Type-4 record. It contains possible finger positions beginning in the left most byte (byte seven of the record). The known or most probable finger position is taken from Table 5. Up to five additional fingers may be referenced by entering the alternate finger positions in the remaining five bytes using the same format. If fewer than five finger position references are to be used the unused bytes are filled with binary 255. To reference all finger positions code 0, for unknown, is used.

Finger position	Finger code	Width (mm)	Length (mm)
Unknown	0	40,0	40,0
Right thumb	1	45,0	40,0
Right index finger	2	40,0	40,0
Right middle finger	3	40,0	40,0
Right ring finger	4	40,0	40,0
Right little finger	5	33,0	40,0
Left thumb	6	45,0	40,0
Left index finger	7	40,0	40,0
Left middle finger	8	40,0	40,0
Left ring finger	9	40,0	40,0
Left little finger	10	33,0	40,0
Plain right thumb	11	30,0	55,0
Plain left thumb	12	30,0	55,0
Plain right four fingers	13	70,0	65,0
Plain left four fingers	14	70,0	65,0

For scene of crime latents only the codes 0 to 10 should be used.

#### 5.1.5. *Field 4.005: Image Scanning Resolution (ISR)*

This one-byte field occupies the 13th byte of a Type-4 record. If it contains '0' then the image has been sampled at the preferred scanning rate of 19,68 pixels/mm (500 pixels per inch). If it contains '1' then the image has been sampled at an alternative scanning rate as specified in the Type-1 record.

#### 5.1.6. *Field 4.006: Horizontal Line Length (HLL)*

This field is positioned at bytes 14 and 15 within the Type-4 record. It specifies the number of pixels contained in each scan line. The first byte will be the most significant.

#### 5.1.7. *Field 4.007: Vertical Line Length (VLL)*

This field records in bytes 16 and 17 the number of scan lines present in the image. The first byte is the most significant.

#### 5.1.8. *Field 4.008: Greyscale Compression Algorithm (GCA)*

This one-byte field specifies the greyscale compression algorithm used to encode the image data. For this implementation, a binary code 1 indicates that WSQ compression (Appendix 7) has been used.

#### 5.1.9. *Field 4.009: The Image*

This field contains a byte stream representing the image. Its structure will obviously depend on the compression algorithm used.

### 6. Type-9 Logical Record: Minutiæ Record

Type-9 records shall contain ASCII text describing minutiæ and related information encoded from a latent. For latent search transaction, there is no limit for these Type-9 records in a file, each of which shall be for a different view or latent.

#### 6.1. Minutiæ extraction

##### 6.1.1. *Minutia type identification*

This standard defines three identifier numbers that are used to describe the minutia type. These are listed in Table 6. A ridge ending shall be designated Type 1. A bifurcation shall be designated Type 2. If a minutia cannot be clearly categorised as one of the above two types, it shall be designated as 'other', Type 0.

Table 6: Minutia types
------------------------

Type	Description
0	Other
1	Ridge ending
2	Bifurcation

#### 6.1.2. *Minutia placement and type*

For templates to be compliant with Section 5 of the ANSI INCITS 378-2004 standard, the following method, which enhances the current INCITS 378-2004 standard, shall be used for determining placement (location and angular direction) of individual minutiae.

The position or location of a minutia representing a ridge ending shall be the point of forking of the medial skeleton of the valley area immediately in front of the ridge ending. If the three legs of the valley area were thinned down to a single-pixel-wide skeleton, the point of the intersection is the location of the minutia. Similarly, the location of the minutia for a bifurcation shall be the point of forking of the medial skeleton of the ridge. If the three legs of the ridge were each thinned down to a single-pixel-wide skeleton, the point where the three legs intersect is the location of the minutia.

After all ridge endings have been converted to bifurcations, all of the minutiae of the dactyloscopic image are represented as bifurcations. The X and Y pixel coordinates of the intersection of the three legs of each minutia can be directly formatted. Determination of the minutia direction can be extracted from each skeleton bifurcation. The three legs of every skeleton bifurcation shall be examined and the endpoint of each leg determined. Figure 6.1.2 illustrates the three methods used for determining the end of a leg that is based on a scanning resolution of 500 ppi.

The ending is established according to the event that occurs first. The pixel count is based on a scan resolution of 500 ppi. Different scan resolutions would imply different pixel counts.

- a distance of 0,064" (the 32nd pixel);
- the end of skeleton leg that occurs between a distance of 0,02" and 0,064" (the 10th through the 32nd pixels); shorter legs are not used;
- a second bifurcation is encountered within a distance of 0,064" (before the 32nd pixel).

*Figure 4*



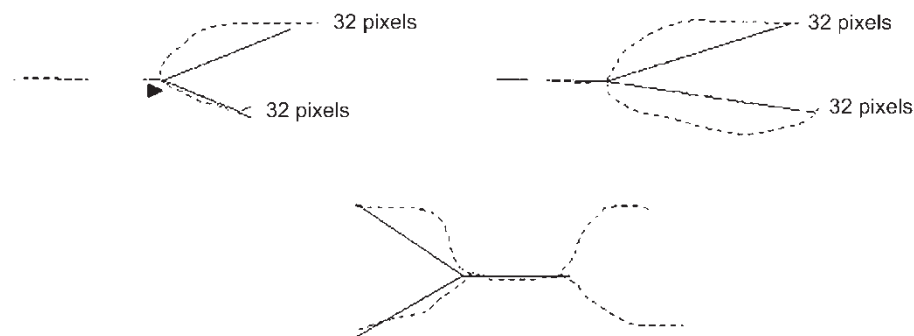

The angle of the minutiae is determined by constructing three virtual rays originating at the bifurcation point and extending to the end of each leg. The smallest of the three angles formed by the rays is bisected to indicate the minutiae direction.

#### 6.1.3. *Coordinate system*

The coordinate system used to express the minutiae of a fingerprint shall be a Cartesian coordinate system. Minutiae locations shall be represented by their x and y coordinates. The origin of the coordinate system shall be the upper left corner of the original image with x increasing to the right and y increasing downward. Both x and y coordinates of a minutiae shall be represented in pixel units from the origin. It should be noted that the location of the origin and units of measure is not in agreement with the convention used in the definitions of the Type 9 in the ANSI/NIST-ITL 1-2000.

#### 6.1.4. *Minutiae direction*

Angles are expressed in standard mathematical format, with zero degrees to the right and angles increasing in the counter clockwise direction. Recorded angles are in the direction pointing back along the ridge for a ridge ending and toward the centre of the valley for a bifurcation. This convention is 180 degrees opposite of the angle convention described in the definitions of the Type 9 in the ANSI/NIST-ITL 1-2000.

### 6.2. Fields for Type-9 Logical record INCITS-378 Format

All fields of the Type-9 records shall be recorded as ASCII text. No binary fields are permissible in this tagged-field record.

#### 6.2.1. *Field 9.001: Logical record length (LEN)*

This mandatory ASCII field shall contain the length of the logical record specifying the total number of bytes, including every character of every field contained in the record.

#### 6.2.2. *Field 9.002: Image designation character (IDC)*

This mandatory two-byte field shall be used for the identification and location of the minutiae data. The IDC contained in this field shall match the IDC found in the file content field of the Type-1 record.

#### 6.2.3. *Field 9.003: Impression type (IMP)*

This mandatory one-byte field shall describe the manner by which the dactyloscopic image information was obtained. The ASCII value of the proper code as selected from Table 4 shall be entered in this field to signify the impression type.

*6.2.4. Field 9.004: Minutiæ format (FMT)*

This field shall contain a 'U' to indicate that the minutiæ are formatted in M1-378 terms. Even though information may be encoded in accordance with the M1-378 standard, all data fields of the Type-9 record shall remain as ASCII text fields.

*6.2.5. Field 9.126: CBEFF information*

This field shall contain three information items. The first information item shall contain the value '27' (0x1B). This is the identification of the CBEFF Format Owner assigned by the International Biometric Industry Association (IBIA) to INCITS Technical Committee M1. The <US> character shall delimit this item from the CBEFF Format Type that is assigned a value of '513' (0x0201) to indicate that this record contains only location and angular direction data without any Extended Data Block information. The <US> character shall delimit this item from the CBEFF Product Identifier (PID) that identifies the 'owner' of the encoding equipment. The vendor establishes this value. It can be obtained from the IBIA website ([www.ibia.org](http://www.ibia.org)) if it is posted.

*6.2.6. Field 9.127: Capture equipment identification*

This field shall contain two information items separated by the <US> character. The first shall contain 'APPF' if the equipment used originally to acquire the image was certified to comply with Appendix F (IAFIS Image Quality Specification, 29 January 1999) of CJIS-RS-0010, the Federal Bureau of Investigation's Electronic Fingerprint Transmission Specification. If the equipment did not comply, it will contain the value of 'NONE'. The second information item shall contain the Capture Equipment ID which is a vendor-assigned product number of the capture equipment. A value of '0' indicates that the capture equipment ID is unreported.

*6.2.7. Field 9.128: Horizontal line length (HLL)*

This mandatory ASCII field shall contain the number of pixels contained on a single horizontal line of the transmitted image. The maximum horizontal size is limited to 65534 pixels.

*6.2.8. Field 9.129: Vertical line length (VLL)*

This mandatory ASCII field shall contain the number of horizontal lines contained in the transmitted image. The maximum vertical size is limited to 65534 pixels.

*6.2.9. Field 9.130: Scale units (SLC)*

This mandatory ASCII field shall specify the units used to describe the image sampling frequency (pixel density). A '1' in this field indicates pixels per inch, or a '2' indicates pixels per centimetre. A '0' in this field indicates no scale is given. In this case, the quotient of HPS/VPS gives the pixel aspect ratio.

*6.2.10. Field 9.131: Horizontal pixel scale (HPS)*

This mandatory ASCII field shall specify the integer pixel density used in the horizontal direction providing the SLC contains a '1' or a '2'. Otherwise, it indicates the horizontal component of the pixel aspect ratio.

*6.2.11. Field 9.132: Vertical pixel scale (VPS)*

This mandatory ASCII field shall specify the integer pixel density used in the vertical direction providing the SLC contains a '1' or a '2'. Otherwise, it indicates the vertical component of the pixel aspect ratio.

*6.2.12. Field 9.133: Finger view*

This mandatory field contains the view number of the finger associated with this record's data. The view number begins with '0' and increments by one to '15'.

*6.2.13. Field 9.134: Finger position (FGP)*

This field shall contain the code designating the finger position that produced the information in this Type-9 record. A code between 1 and 10 taken from Table 5 or the appropriate palm code from Table 10 shall be used to indicate the finger or palm position.

*6.2.14. Field 9.135: Finger quality*

The field shall contain the quality of the overall finger minutiae data and shall be between 0 and 100. This number is an overall expression of the quality of the finger record, and represents quality of the original image, of the minutia extraction and any additional operations that may affect the minutiae record.

*6.2.15. Field 9.136: number of minutiae*

The mandatory field shall contain a count of the number of minutiae recorded in this logical record.

*6.2.16. Field 9.137: Finger minutiae data*

This mandatory field has six information items separated by the <US> character. It consists of several subfields, each containing the details of single minutiae. The total number of minutiae subfields must agree with the count found in field 136. The first information item is the minutiae index number, which shall be initialised to '1' and incremented by '1' for each additional minutia in the fingerprint. The second and third information items are the 'x' coordinate and 'y' coordinates of the minutiae in pixel units. The fourth information item is the minutiae angle recorded in units of two degrees. This value shall be nonnegative between 0 and 179. The fifth information item is the minutiae type. A value of '0' is used to represent minutiae of type 'OTHER', a value of '1' for a ridge ending and a value of '2' for a ridge bifurcation. The sixth information item represents the quality of each minutiae. This value shall range from 1 as a minimum to 100 as a maximum. A value of '0' indicates that no quality value is available. Each subfield shall be separated from the next with the use of the <RS> separator character.

*6.2.17. Field 9.138: Ridge count information*

This field consists of a series of subfields each containing three information items. The first information item of the first subfield shall indicate the ridge count extraction method. A '0' indicates that no assumption shall be made about the method used to extract ridge counts, nor their order in the record. A '1' indicates that for each centre minutia, ridge count data was extracted to the nearest neighbouring minutia in four quadrants, and ridge counts for each centre minutia are listed together. A '2' indicates that for each centre minutia, ridge count data was extracted to the nearest neighbouring minutia in eight octants, and ridge counts for each centre minutia are listed together. The remaining two information items of the first subfield shall both contain '0'. Information items shall be separated by the <US> separator character. Subsequent subfields will contain the centre minutia index number as the first information item, the neighbouring minutia index number as the second information item, and the number of ridges crossed as the third information item. Subfields shall be separated by the <RS> separator character.

#### 6.2.18. Field 9.139: Core information

This field will consist of one subfield for each core present in the original image. Each subfield consists of three information items. The first two items contain the 'x' and 'y' coordinate positions in pixel units. The third information item contains the angle of the core recorded in units of 2 degrees. The value shall be a nonnegative value between 0 and 179. Multiple cores will be separated by the <RS> separator character.

#### 6.2.19. Field 9.140: Delta information

This field will consist of one subfield for each delta present in the original image. Each subfield consists of three information items. The first two items contain the 'x' and 'y' coordinate positions in pixel units. The third information item contains the angle of the delta recorded in units of 2 degrees. The value shall be a nonnegative value between 0 and 179. Multiple cores will be separated by the <RS> separator character.

### 7. Type-13 variable-resolution latent image record

The Type-13 tagged-field logical record shall contain image data acquired from latent images. These images are intended to be transmitted to agencies that will automatically extract or provide human intervention and processing to extract the desired feature information from the images.

Information regarding the scanning resolution used, the image size, and other parameters required to process the image, are recorded as tagged-fields within the record.

Table 7: Type-13 variable-resolution latent record layout

Ident	Cond. code	Field Number	Field name	Char type	Field size per occurrence		Occur count		Max byte count
					min.	max.	min	max	
LEN	M	13.001	LOGICAL	N	4	8	1	1	15

			RECOR D LENGT H						
IDC	M	13.002	IMAGE DESIGN ATION CHARA CTER	N	2	5	1	1	12
IMP	M	13.003	IMPRES SION TYPE	A	2	2	1	1	9
SRC	M	13.004	SOURC E AGENC Y/ORI	AN	6	35	1	1	42
LCD	M	13.005	LATENT CAPTU RE DATE	N	9	9	1	1	16
HLL	M	13.006	HORIZO NTAL LINE LENGT H	N	4	5	1	1	12
VLL	M	13.007	VERTIC AL LINE LENGT H	N	4	5	1	1	12
SLC	M	13.008	SCALE UNITS	N	2	2	1	1	9
HPS	M	13.009	HORIZO NTAL PIXEL SCALE	N	2	5	1	1	12

VPS	M	13.010	VERTICAL PIXEL SCALE	N	2	5	1	1	12
CGA	M	13.011	COMPRESSION ALGORITHM	A	5	7	1	1	14
BPX	M	13.012	BITS PER PIXEL	N	2	3	1	1	10
FGP	M	13.013	FINGER POSITION	N	2	3	1	6	25
RSV		13.014 13.019	RESERVED FOR FUTURE DEFINITION	—	—	—	—	—	—
COM	O	13.020	COMMENT	A	2	128	0	1	135
RSV		13.021 13.199	RESERVED FOR FUTURE DEFINITION	—	—	—	—	—	—
UDF	O	13.200 13.998	USER- DEFINED FIELDS	—	—	—	—	—	—
DAT	M	13.999	IMAGE DATA	B	2	—	1	1	—

*Key for character type: N = Numeric; A = Alphabetic; AN = Alphanumeric; B = Binary*

## 7.1. Fields for the Type-13 logical record

The following paragraphs describe the data contained in each of the fields for the Type-13 logical record.

Within a Type-13 logical record, entries shall be provided in numbered fields. It is required that the first two fields of the record are ordered, and the field containing the image data shall be the last physical field in the record. For each field of the Type-13 record, Table 7 lists the 'condition code' as being mandatory 'M' or optional 'O', the field number, the field name, character type, field size, and occurrence limits. Based on a three digit field number, the maximum byte count size for the field is given in the last column. As more digits are used for the field number, the maximum byte count will also increase. The two entries in the 'field size per occurrence' include all character separators used in the field. The 'maximum byte count' includes the field number, the information, and all the character separators including the 'GS' character.

### 7.1.1. *Field 13.001: Logical record length (LEN)*

This mandatory ASCII field shall contain the total count of the number of bytes in the Type-13 logical record. Field 13.001 shall specify the length of the record including every character of every field contained in the record and the information separators.

### 7.1.2. *Field 13.002: Image designation character (IDC)*

This mandatory ASCII field shall be used to identify the latent image data contained in the record. This IDC shall match the IDC found in the file content (CNT) field of the Type-1 record.

### 7.1.3. *Field 13.003: Impression type (IMP)*

This mandatory one- or two-byte ASCII field shall indicate the manner by which the latent image information was obtained. The appropriate latent code choice selected from Table 4 (finger) or Table 9 (palm) shall be entered in this field.

### 7.1.4. *Field 13.004: Source agency/ORI (SRC)*

This mandatory ASCII field shall contain the identification of the administration or organisation that originally captured the facial image contained in the record. Normally, the Originating Agency Identifier (ORI) of the agency that captured the image will be contained in this field. It consists of two information items in the following format: CC/agency.

The first information item contains the Interpol Country Code, two alpha-numeric characters long. The second item, agency, is a free text identification of the agency, up to a maximum of 32 alpha-numeric characters.

### 7.1.5. *Field 13.005: Latent capture date (LCD)*

This mandatory ASCII field shall contain the date that the latent image contained in the record was captured. The date shall appear as eight digits in the format CCYYMMDD. The CCYY characters shall represent the year the image was captured; the MM characters shall be the tens and unit values of the month; and the DD characters shall be the tens and unit values of the day in the month. For example, 20000229 represents 29 February 2000. The complete date shall be a legitimate date.

**7.1.6. Field 13.006: Horizontal line length (HLL)**

This mandatory ASCII field shall contain the number of pixels contained on a single horizontal line of the transmitted image.

**7.1.7. Field 13.007: Vertical line length (VLL)**

This mandatory ASCII field shall contain the number of horizontal lines contained in the transmitted image.

**7.1.8. Field 13.008: Scale units (SLC)**

This mandatory ASCII field shall specify the units used to describe the image sampling frequency (pixel density). A '1' in this field indicates pixels per inch, or a '2' indicates pixels per centimetre. A '0' in this field indicates no scale is given. In this case, the quotient of HPS/VPS gives the pixel aspect ratio.

**7.1.9. Field 13.009: Horizontal pixel scale (HPS)**

This mandatory ASCII field shall specify the integer pixel density used in the horizontal direction providing the SLC contains a '1' or a '2'. Otherwise, it indicates the horizontal component of the pixel aspect ratio.

**7.1.10. Field 13.010: Vertical pixel scale (VPS)**

This mandatory ASCII field shall specify the integer pixel density used in the vertical direction providing the SLC contains a '1' or a '2'. Otherwise, it indicates the vertical component of the pixel aspect ratio.

**7.1.11. Field 13.011: Compression algorithm (CGA)**

This mandatory ASCII field shall specify the algorithm used to compress greyscale images. See Appendix 7 for the compression codes.

**7.1.12. Field 13.012: Bits per pixel (BPX)**

This mandatory ASCII field shall contain the number of bits used to represent a pixel. This field shall contain an entry of '8' for normal greyscale values of '0' to '255'. Any entry in this field greater than '8' shall represent a greyscale pixel with increased precision.

**7.1.13. Field 13.013: Finger/palm position (FGP)**

This mandatory tagged-field shall contain one or more of the possible finger or palm positions that may match the latent image. The decimal code number corresponding to the known or most probable finger position shall be taken from Table 5 or the most probable palm position from Table 10 and entered as a one- or two-character ASCII subfield. Additional finger and/or palm positions may be referenced by entering the alternate position codes as subfields separated by the 'RS' separator character. The code '0', for 'Unknown Finger', shall be used to reference every finger position from one through ten. The code '20', for 'Unknown Palm', shall be used to reference every listed palmprint position.



**7.1.14. Field 13.014-019: Reserved for future definition (RSV)**

These fields are reserved for inclusion in future revisions of this standard. None of these fields are to be used at this revision level. If any of these fields are present, they are to be ignored.

**7.1.15. Field 13.020: Comment (COM)**

This optional field may be used to insert comments or other ASCII text information with the latent image data.

**7.1.16. Field 13.021-199: Reserved for future definition (RSV)**

These fields are reserved for inclusion in future revisions of this standard. None of these fields are to be used at this revision level. If any of these fields are present, they are to be ignored.

**7.1.17. Fields 13.200-998: User-defined fields (UDF)**

These fields are user-definable fields and will be used for future requirements. Their size and content shall be defined by the user and be in accordance with the receiving agency. If present they shall contain ASCII textual information.

**7.1.18. Field 13.999: Image data (DAT)**

This field shall contain all data from a captured latent image. It shall always be assigned field number 999 and shall be the last physical field in the record. For example, '13.999:' is followed by image data in a binary representation.

Each pixel of uncompressed greyscale data shall normally be quantised to eight bits (256 grey levels) contained in a single byte. If the entry in BPX Field 13.012 is greater or less than '8', the number of bytes required to contain a pixel will be different. If compression is used, the pixel data shall be compressed in accordance with the compression technique specified in the GCA field.

**7.2. End of Type-13 variable-resolution latent image record**

For the sake of consistency, immediately following the last byte of data from Field 13.999 an 'FS' separator shall be used to separate it from the next logical record. This separator shall be included in the length field of the Type-13 record.

**8. Type-15 variable-resolution palmprint image record**

The Type-15 tagged-field logical record shall contain and be used to exchange palmprint image data together with fixed and user-defined textual information fields pertinent to the digitised image. Information regarding the scanning resolution used, the image size and other parameters or comments required to process the image are recorded as tagged-fields within the record. Palmprint images transmitted to other agencies will be processed by the recipient agencies to extract the desired feature information required for matching purposes.

The image data shall be acquired directly from a subject using a live-scan device, or from a palmprint card or other media that contains the subject's palmprints.

Any method used to acquire the palmprint images shall be capable of capturing a set of images for each hand. This set shall include the writer's palm as a single scanned image, and the entire area of the full palm extending from the wrist bracelet to the tips of the fingers as one or two scanned images. If two images are used to represent the full palm, the lower image shall extend from the wrist bracelet to the top of the interdigital area (third finger joint) and shall include the thenar, and hypothenar areas of the palm. The upper image shall extend from the bottom of the interdigital area to the upper tips of the fingers. This provides an adequate amount of overlap between the two images that are both located over the interdigital area of the palm. By matching the ridge structure and details contained in this common area, an examiner can confidently state that both images came from the same palm.

As a palmprint transaction may be used for different purposes, it may contain one or more unique image areas recorded from the palm or hand. A complete palmprint record set for one individual will normally include the writer's palm and the full palm image(s) from each hand. Since a tagged-field logical image record may contain only one binary field, a single Type-15 record will be required for each writer's palm and one or two Type-15 records for each full palm. Therefore, four to six Type-15 records will be required to represent the subject's palmprints in a normal palmprint transaction.

#### 8.1. Fields for the Type-15 logical record

The following paragraphs describe the data contained in each of the fields for the Type-15 logical record.

Within a Type-15 logical record, entries shall be provided in numbered fields. It is required that the first two fields of the record are ordered, and the field containing the image data shall be the last physical field in the record. For each field of the Type-15 record, Table 8 lists the 'condition code' as being mandatory 'M' or optional 'O', the field number, the field name, character type, field size, and occurrence limits. Based on a three digit field number, the maximum byte count size for the field is given in the last column. As more digits are used for the field number, the maximum byte count will also increase. The two entries in the 'field size per occurrence' include all character separators used in the field. The 'maximum byte count' includes the field number, the information, and all the character separators including the 'GS' character.

##### 8.1.1. *Field 15.001: Logical record length (LEN)*

This mandatory ASCII field shall contain the total count of the number of bytes in the Type-15 logical record. Field 15.001 shall specify the length of the record including every character of every field contained in the record and the information separators.

##### 8.1.2. *Field 15.002: Image designation character (IDC)*

This mandatory ASCII field shall be used to identify the palmprint image contained in the record. This IDC shall match the IDC found in the file content (CNT) field of the Type-1 record.

##### 8.1.3. *Field 15.003: Impression type (IMP)*

This mandatory one-byte ASCII field shall indicate the manner by which the palmprint image information was obtained. The appropriate code selected from Table 9 shall be entered in this field.

##### 8.1.4. *Field 15.004: Source agency/ORI (SRC)*

This mandatory ASCII field shall contain the identification of the administration or organisation that originally captured the facial image contained in the record. Normally, the Originating Agency Identifier (ORI) of the agency that captured the image will be contained in this field. It consists of two information items in the following format: CC/agency.

The first information item contains the Interpol Country Code, two alpha-numeric characters long. The second item, agency, is a free text identification of the agency, up to a maximum of 32 alpha-numeric characters.

**8.1.5. Field 15.005: Palmprint capture date (PCD)**

This mandatory ASCII field shall contain the date that the palmprint image was captured. The date shall appear as eight digits in the format CCYYMMDD. The CCYY characters shall represent the year the image was captured; the MM characters shall be the tens and unit values of the month; and the DD characters shall be the tens and units values of the day in the month. For example, the entry 20000229 represents 29 February 2000. The complete date shall be a legitimate date.

**8.1.6. Field 15.006: Horizontal line length (HLL)**

This mandatory ASCII field shall contain the number of pixels contained on a single horizontal line of the transmitted image.

**8.1.7. Field 15.007: Vertical line length (VLL)**

This mandatory ASCII field shall contain the number of horizontal lines contained in the transmitted image.

**8.1.8. Field 15.008: Scale units (SLC)**

This mandatory ASCII field shall specify the units used to describe the image sampling frequency (pixel density). A '1' in this field indicates pixels per inch, or a '2' indicates pixels per centimetre. A '0' in this field indicates no scale is given. In this case, the quotient of HPS/VPS gives the pixel aspect ratio.

**8.1.9. Field 15.009: Horizontal pixel scale (HPS)**

This mandatory ASCII field shall specify the integer pixel density used in the horizontal direction providing the SLC contains a '1' or a '2'. Other-wise, it indicates the horizontal component of the pixel aspect ratio.

**8.1.10. Field 15.010: Vertical pixel scale (VPS)**

This mandatory ASCII field shall specify the integer pixel density used in the vertical direction providing the SLC contains a '1' or a '2'. Otherwise, it indicates the vertical component of the pixel aspect ratio.

Table 8: Type-15 variable-resolution palmprint record layout									
Ident	Cond.	Field	Field	Char	Field	size	per	Occur count	Max

	code	number	name	type	occurrence				byte count
					min.	max.	min	max	
LEN	M	15.001	LOGICAL RECORD LENGTH	N	4	8	1	1	15
IDC	M	15.002	IMAGE DESIGNATION CHARACTER	N	2	5	1	1	12
IMP	M	15.003	IMPRESSION TYPE	N	2	2	1	1	9
SRC	M	15.004	SOURCE AGENCY/ORI	AN	6	35	1	1	42
PCD	M	15.005	PALMPRINT CAPTURE DATE	N	9	9	1	1	16
HLL	M	15.006	HORIZONTAL LINE LENGTH	N	4	5	1	1	12
VLL	M	15.007	VERTICAL LINE LENGTH	N	4	5	1	1	12
SLC	M	15.008	SCALE	N	2	2	1	1	9

			UNITS						
HPS	M	15.009	HORIZONTAL PIXEL SCALE	N	2	5	1	1	12
VPS	M	15.010	VERTICAL PIXEL SCALE	N	2	5	1	1	12
CGA	M	15.011	COMPRESSION ALGORITHM	AN	5	7	1	1	14
BPX	M	15.012	BITS PER PIXEL	N	2	3	1	1	10
PLP	M	15.013	PALMP RINT POSITION	N	2	3	1	1	10
RSV		15.014 15.019	RESERVED FOR FUTURE INCLUSION	—	—	—	—	—	—
COM	O	15.020	COMMENT	AN	2	128	0	1	128
RSV		15.021 15.199	RESERVED FOR FUTURE INCLUSION	—	—	—	—	—	—
UDF	O	15.200	USER- DEFINE	—	—	—	—	—	—

		15.998	D FIELDS						
DAT	M	15.999	IMAGE DATA	B	2	—	1	1	—

Table 9: Palm Impression Type	
Description	Code
Live-scan palm	10
Nonlive-scan palm	11
Latent palm impression	12
Latent palm tracing	13
Latent palm photo	14
Latent palm lift	15

#### 8.1.11. Field 15.011: Compression algorithm (CGA)

This mandatory ASCII field shall specify the algorithm used to compress greyscale images. An entry of 'NONE' in this field indicates that the data contained in this record are uncompressed. For those images that are to be compressed, this field shall contain the preferred method for the compression of tenprint fingerprint images. Valid compression codes are defined in Appendix 7.

#### 8.1.12. Field 15.012: Bits per pixel (BPX)

This mandatory ASCII field shall contain the number of bits used to represent a pixel. This field shall contain an entry of '8' for normal greyscale values of '0' to '255'. Any entry in this field greater than or less than '8' shall represent a greyscale pixel with increased or decreased precision respectively.

Table 10: Palm Codes, Areas and Sizes				
Palm Position	Palm code	Image area (mm <sup>2</sup> )	Width (mm)	Height (mm)
Unknown Palm	20	28387	139,7	203,2
Right Full Palm	21	28387	139,7	203,2
Right Writer s Palm	22	5645	44,5	127,0

Left Full Palm	23	28387	139,7	203,2
Left Writer s Palm	24	5645	44,5	127,0
Right Lower Palm	25	19516	139,7	139,7
Right Upper Palm	26	19516	139,7	139,7
Left Lower Palm	27	19516	139,7	139,7
Left Upper Palm	28	19516	139,7	139,7
Right Other	29	28387	139,7	203,2
Left Other	30	28387	139,7	203,2

#### 8.1.13. *Field 15.013: Palmprint position (PLP)*

This mandatory tagged-field shall contain the palmprint position that matches the palmprint image. The decimal code number corresponding to the known or most probable palmprint position shall be taken from Table 10 and entered as a two-character ASCII subfield. Table 10 also lists the maximum image areas and dimensions for each of the possible palmprint positions.

#### 8.1.14. *Field 15.014-019: Reserved for future definition (RSV)*

These fields are reserved for inclusion in future revisions of this standard. None of these fields are to be used at this revision level. If any of these fields are present, they are to be ignored.

#### 8.1.15. *Field 15.020: Comment (COM)*

This optional field may be used to insert comments or other ASCII text information with the palmprint image data.

#### 8.1.16. *Field 15.021-199: Reserved for future definition (RSV)*

These fields are reserved for inclusion in future revisions of this standard. None of these fields are to be used at this revision level. If any of these fields are present, they are to be ignored.

#### 8.1.17. *Fields 15.200-998: User-defined fields (UDF)*

These fields are user-definable fields and will be used for future requirements. Their size and content shall be defined by the user and be in accordance with the receiving agency. If present, they shall contain ASCII textual information.

#### 8.1.18. *Field 15.999: Image data (DAT)*

This field shall contain all of the data from a captured palmprint image. It shall always be assigned field number 999 and shall be the last physical field in the record. For example, '15.999:' is followed

by image data in a binary representation. Each pixel of uncompressed greyscale data shall normally be quantised to eight bits (256 grey levels) contained in a single byte. If the entry in BPX Field 15.012 is greater or less than 8, the number of bytes required to contain a pixel will be different. If compression is used, the pixel data shall be compressed in accordance with the compression technique specified in the CGA field.

## 8.2. End of Type-15 variable-resolution palmprint image record

For the sake of consistency, immediately following the last byte of data from Field 15.999 an 'FS' separator shall be used to separate it from the next logical record. This separator shall be included in the length field of the Type-15 record.

## 8.3. Additional Type-15 variable-resolution palmprint image records

Additional Type-15 records may be included in the file. For each additional palmprint image, a complete Type-15 logical record together with the 'FS' separator is required.

Table 11: Maximum numbers of candidates accepted for verification per transmission							
Type of AFIS Search	TP/TP	LT/TP	LP/PP	TP/UL	LT/UL	PP/ULP	LP/ULP
Maximum Number of Candidates	1	10	5	5	5	5	5

Search types:

TP/TP: ten-print against ten-print

LT/TP: fingerprint latent against ten-print

LP/PP: palmprint latent against palmprint

TP/UL: ten-print against unsolved fingerprint latent

LT/UL: fingerprint latent against unsolved fingerprint latent

PP/ULP: palmprint against unsolved palmprint latent

LP/ULP: palmprint latent against unsolved palmprint latent

## 9. Appendices to Chapter 2 (exchange of dactyloscopic data)

### 9.1. Appendix 1: ASCII Separator Codes



ASCII	Position <sup>148</sup>	Description
LF	1/10	Separates error codes in Field 2.074
FS	1/12	Separates logical records of a file
GS	1/13	Separates fields of a logical record
RS	1/14	Separates the subfields of a record field
US	1/15	Separates individual information items of the field or subfield

## 9.2. Appendix 2: Calculation of Alpha-Numeric Check Character

For TCN and TCR (Fields 1.09 and 1.10):

The number corresponding to the check character is generated using the following formula:

$$(YY * 10^8 + SSSSSSS) \text{ Modulo } 23$$

Where YY and SSSSSSS are the numerical values of the last two digits of the year and the serial number respectively.

The check character is then generated from the look-up table given below.

For CRO (Field 2.010)

The number corresponding to the check character is generated using the following formula:

$$(YY * 10^6 + NNNNNN) \text{ Modulo } 23$$

Where YY and NNNNNN are the numerical values of the last two digits of the year and the serial number respectively.

The check character is then generated from the look-up table given below.

Check Character Look-up Table		
1-A	9-J	17-T
2-B	10-K	18-U
3-C	11-L	19-V

---

<sup>148</sup> This is the position as defined in the ASCII standard.

4-D	12-M	20-W
5-E	13-N	21-X
6-F	14-P	22-Y
7-G	15-Q	0-Z
8-H	16-R	

### 9.3. Appendix 3: Character Codes

7-bit ANSI code for information interchange										
ASCII Character Set										
+	0	1	2	3	4	5	6	7	8	9
30				!	'	#	\$	%	&	'
40	(	)	*	+	,	-	.	/	0	1
50	2	3	4	5	6	7	8	9	:	;
60	<	=	>	?	@	A	B	C	D	E
70	F	G	H	I	J	K	L	M	N	O
80	P	Q	R	S	T	U	V	W	X	Y
90	Z	[	\	]	^	_	`	a	b	c
100	d	e	f	g	h	i	j	k	l	m
110	n	o	p	q	r	s	t	u	v	w
120	x	y	z	{{		}}	~			

### 9.4. Appendix 4: Transaction Summary

Type 1 Record (mandatory)					
Identifier	Field number	Field name	CPS/PMS	SRE	ERR

LEN	1.001	Logical Record Length	M	M	M
VER	1.002	Version Number	M	M	M
CNT	1.003	File Content	M	M	M
TOT	1.004	Type of Transaction	M	M	M
DAT	1.005	Date	M	M	M
PRY	1.006	Priority	M	M	M
DAI	1.007	Destination Agency	M	M	M
ORI	1.008	Originating Agency	M	M	M
TCN	1.009	Transaction Control Number	M	M	M
TCR	1.010	Transaction Control Reference	C	M	M
NSR	1.011	Native Scanning Resolution	M	M	M
NTR	1.012	Nominal Transmitting Resolution	M	M	M
DOM	1.013	Domain name	M	M	M
GMT	1.014	Greenwich mean time	M	M	M

Under the Condition Column:

O = Optional; M = Mandatory; C = Conditional if transaction is a response to the origin agency

Type 2 Record (mandatory)						
Identifier	Field number	Field name	CPS/PMS	MPS/MMS	SRE	ERR
LEN	2.001	Logical Record Length	M	M	M	M
IDC	2.002	Image Designation Character	M	M	M	M
SYS	2.003	System Information	M	M	M	M
CNO	2.007	Case Number	—	M	C	—

SQN	2.008	Sequence Number	—	C	C	—
MID	2.009	Latent Identifier	—	C	C	—
CRN	2.010	Criminal Reference Number	M	—	C	—
MN1	2.012	Miscellaneous Identification Number	—	—	C	C
MN2	2.013	Miscellaneous Identification Number	—	—	C	C
MN3	2.014	Miscellaneous Identification Number	—	—	C	C
MN4	2.015	Miscellaneous Identification Number	—	—	C	C
INF	2.063	Additional Information	O	O	O	O
RLS	2.064	Respondents List	—	—	M	—
ERM	2.074	Status/Error Message Field	—	—	—	M
ENC	2.320	Expected Number of Candidates	M	M	—	—

Under the Condition Column:

O = Optional; M = Mandatory; C = Conditional if data is available

*	=	if the transmission of the data is in accordance with domestic law (not covered by Articles LAW.PRUM.11 [Dactyloscopic data] and LAW.PRUM.12 [Automated searching of dactyloscopic data])
---	---	---

#### 9.5. Appendix 5: Type-1 Record Definitions

Identifier	Condition	Field number	Field name	Character type	Example data
LEN	M	1.001	Logical Record Length	N	1.001:230{{GS}} }

VER	M	1.002	Version Number	N	1.002:0300{{GS}}
CNT	M	1.003	File Content	N	1.003:1{{US}}15{{RS}}2{{US}}00{{RS}}4{{US}}01{{RS}}4{{US}}02{{RS}}4{{US}}03{{RS}}4{{US}}04{{RS}}4{{US}}05{{RS}}4{{US}}06{{RS}}4{{US}}07{{RS}}4{{US}}08{{RS}}4{{US}}09{{RS}}4{{US}}10{{RS}}4{{US}}11{{RS}}4{{US}}12{{RS}}4{{US}}13{{RS}}4{{US}}14{{GS}}
TOT	M	1.004	Type of Transaction	A	1.004:CPS{{GS}}
DAT	M	1.005	Date	N	1.005:20050101{{GS}}
PRY	M	1.006	Priority	N	1.006:4{{GS}}
DAI	M	1.007	Destination Agency	1*	1.007:DE/BKA{{GS}}
ORI	M	1.008	Originating Agency	1*	1.008:NL/NAFIS{{GS}}
TCN	M	1.009	Transaction Control Number	AN	1.009:0200000004F{{GS}}
TCR	C	1.010	Transaction Control Reference	AN	1.010:0200000004F{{GS}}
NSR	M	1.011	Native Scanning	AN	1.011:19.68{{G}}

			Resolution		S}}
NTR	M	1.012	Nominal Transmitting Resolution	AN	1.012:19,68{{GS}}
DOM	M	1.013	Domain Name	AN	1.013: INT- I{{US}}4,22{{GS}}
GMT	M	1.014	Greenwich Mean Time	AN	1.014:20050101 125959Z

Under the Condition Column: O = Optional, M = Mandatory, C = Conditional

Under the Character Type Column: A = Alpha, N = Numeric, B = Binary

1\* allowed characters for agency name are ['0..9', 'A..Z', 'a..z', '\_', ':', ', ', '-']

#### 9.6. Appendix 6: Type-2 Record Definitions

Identifier	Condition	Field number	Field name	Character type	Example data
LEN	M	2.001	Logical Record Length	N	2.001:909{{GS}}
IDC	M	2.002	Image Designation Character	N	2.002:00{{GS}}
SYS	M	2.003	System Information	N	2.003:0422{{GS}}
CRN	M	2.010	Criminal Reference Number	AN	2.010:DE/E999999999{{GS}}
INF	O	2.063	Additional Information	1*	2.063:Additional Information 123{{GS}}

ENC	M	2.320	Expected Number of Candidates	N	2.320:1{{GS}}
-----	---	-------	-------------------------------	---	---------------

Table A.6.2: SRE-Transaction

Identifier	Condition	Field number	Field name	Character type	Example data
LEN	M	2.001	Logical Record Length	N	2.001:909{{GS}}
IDC	M	2.002	Image Designation Character	N	2.002:00{{GS}}
SYS	M	2.003	System Information	N	2.003:0422{{GS}}
CRN	C	2.010	Criminal Reference Number	AN	2.010:NL/2222222222{{GS}}
MN1	C	2.012	Miscellaneous Identification Number	AN	2.012:E999999999{{GS}}
MN2	C	2.013	Miscellaneous Identification Number	AN	2.013:E999999999{{GS}}
MN3	C	2.014	Miscellaneous Identification Number	N	2.014:0001{{GS}}
MN4	C	2.015	Miscellaneous Identification Number	A	2.015:A{{GS}}
INF	O	2.063	Additional Information	1*	2.063:Additional Information 123{{GS}}
RLS	M	2.064	Respondents	AN	2.064:CPS{{RS}}001/001

			List		{{RS}}999999{{GS}}
--	--	--	------	--	--------------------

Table A.6.3: ERR-Transaction					
Identifier	Condition	Field number	Field name	Character type	Example data
LEN	M	2.001	Logical Record Length	N	2.001:909{{GS}}
IDC	M	2.002	Image Designation Character	N	2.002:00{{GS}}
SYS	M	2.003	System Information	N	2.003:0422{{GS}}
MN1	M	2.012	Miscellaneous Identification Number	AN	2.012:E999999999{{GS}}
MN2	C	2.013	Miscellaneous Identification Number	AN	2.013:E999999999{{GS}}
MN3	C	2.014	Miscellaneous Identification Number	N	2.014:0001{{GS}}
MN4	C	2.015	Miscellaneous Identification Number	A	2.015:A{{GS}}
INF	O	2.063	Additional Information	1*	2.063:Additional Information 123{{GS}}
ERM	M	2.074	Status/Error Message Field	AN	2.074: 201: IDC - 1 FIELD 1.009 WRONG CONTROL CHARACTER {{LF}} 115: IDC 0 FIELD 2.003 INVALID SYSTEM INFORMATION {{GS}}



Identifier	Condition	Field number	Field name	Character type	Example data
LEN	M	2.001	Logical Record Length	N	2.001:909{{GS}}
IDC	M	2.002	Image Designation Character	N	2.002:00{{GS}}
SYS	M	2.003	System Information	N	2.003:0422{{GS}}
CNO	M	2.007	Case Number	AN	2.007:E999999999{{GS}}
SQN	C	2.008	Sequence Number	N	2.008:0001{{GS}}
MID	C	2.009	Latent Identifier	A	2.009:A{{GS}}
INF	O	2.063	Additional Information	1*	2.063:Additional Information 123{{GS}}
ENC	M	2.320	Expected Number of Candidates	N	2.320:1{{GS}}

Under the Condition Column: O = Optional, M = Mandatory, C = Conditional

Under the Character Type Column: A = Alpha, N = Numeric, B = Binary

1\* allowed characters are ['0..9', 'A..Z', 'a..z', '\_', ':', ',', '-', ';']

## 9.7. Appendix 7: Greyscale Compression Codes

### Compression Codes

Compression	Value	Remarks
Wavelet Scalar Quantisation Greyscale Fingerprint Image Compression	WSQ	Algorithm to be used for the compression of greyscale images in Type-4, Type-7 and Type-13 to Type-15 records. Shall not be used for

Specification  IAFIS-IC-0010(V3), dated 19 December 1997		resolutions > 500dpi.
JPEG 2000  [ISO 15444/ITU T.800]	J2K	To be used for lossy and losslessly compression of greyscale images in Type-13 to Type-15 records. Strongly recommended for resolutions > 500 dpi

#### 9.8. Appendix 8: Mail specification

To improve the internal workflow the mail subject of a PRUEM transaction has to be filled with the country code (CC) of the State that send the message and the Type of Transaction (TOT Field 1.004).

Format: CC/type of transaction

Example: 'DE/CPS'

The mail body can be empty.

### CHAPTER 3: Exchange of vehicle registration data

#### 1. Common data-set for automated search of vehicle registration data

##### 1.1. Definitions

The definitions of mandatory and optional data elements set out in Article 14(4) of Chapter 0 are as follows:

##### Mandatory (M):

The data element has to be communicated when the information is available in a State's national register. Therefore there is an obligation to exchange the information when available.

##### Optional (O):

The data element may be communicated when the information is available in a State's national register. Therefore there is no obligation to exchange the information even when the information is available.

An indication (Y) is given for each element in the data set where the element is specifically identified as important in relation with Article LAW.PRUM.15 [Automated searching of vehicle registration data].

#### 1.2. Vehicle/owner/holder search

##### 1.2.1. Triggers for the search

There are two different ways to search for the information as defined in the next paragraph:

- by Chassis Number (VIN), Reference Date and Time (optional),
- by License Plate Number, Chassis Number (VIN) (optional), Reference Date and Time (optional).

By means of these search criteria, information related to one and sometimes more vehicles will be returned. If information for only one vehicle has to be returned, all the items are returned in one response. If more than one vehicle is found, the requested State itself can determine which items will be returned; all items or only the items to refine the search (e.g. because of privacy reasons or because of performance reasons).

The items necessary to refine the search are pictured in paragraph 1.2.2.1. In paragraph 1.2.2.2 the complete information set is described.

When the search is done by Chassis Number, Reference Date and Time, the search can be done in one or all of the participating States.

When the search is done by License Number, Reference Data and Time, the search has to be done in one specific State.

Normally the actual Date and Time is used to make a search, but it is possible to conduct a search with a Reference Date and Time in the past. When a search is made with a Reference Date and Time in the past and historical information is not available in the register of the specific State because no such information is registered at all, the actual information can be returned with an indication that the information is actual information.

### 1.2.2. Data set

#### 1.2.2.1. Items to be returned necessary for the refinement of the search

Item	M/O <sup>149</sup>	Remarks	Prüm Y/N <sup>150</sup>
Data relating to vehicles			
Licence number	M		Y
Chassis number/VIN	M		Y
Country of registration	M		Y
Make	M	(D.1 <sup>151</sup> ) e.g. Ford, Opel, Renault,	Y

---

<sup>149</sup> M = mandatory when available in national register, O = optional.

<sup>150</sup> All the attributes specifically allocated by the States are indicated with Y.

		etc.	
Commercial type of the vehicle	M	(D.3) e.g. Focus, Astra, Megane	Y
EU Category Code	M	(J) mopeds, motorbikes, cars, etc.	Y

#### 1.2.2.2. Complete data set

Item	M/O <sup>152</sup>	Remarks	Prüm Y/N
Data relating to holders of the vehicle		(C.1 <sup>153</sup> ) The data refer to the holder of the specific registration certificate.	
Registration holders' (company) name	M	(C.1.1.)  separate fields will be used for surname, infixes, titles, etc., and the name in printable format will be communicated	Y
First name	M	(C.1.2)  separate fields for first name(s) and initials will be used, and the name in printable format will be communicated	Y
Address	M	(C.1.3)  separate fields will be used for Street, House number and Annex, Zip code, Place of residence, Country of residence, etc., and the Address in printable format will be communicated	Y
Gender	M	Male, female	Y
Date of birth	M		Y

---

<sup>151</sup> Harmonised document abbreviation, see Council Directive 1999/37/EC of 29 April 1999.

<sup>152</sup> M = mandatory when available in national register, O = optional.

<sup>153</sup> Harmonised document abbreviation, see Council Directive 1999/37/EC of 29 April 1999.

Legal entity	M	individual, association, company, firm, etc.	Y
Place of Birth	O		Y
ID Number	O	An identifier that uniquely identifies the person or the company.	N
Type of ID Number	O	The type of ID Number (e.g. passport number).	N
Start date holdership	O	Start date of the holdership of the car. This date will often be the same as printed under (I) on the registration certificate of the vehicle.	N
End date holdership	O	End data of the holdership of the car.	N
Type of holder	O	If there is no owner of the vehicle (C.2) the reference to the fact that the holder of the registration certificate: <ul style="list-style-type: none"> <li>– is the vehicle owner,</li> <li>– is not the vehicle owner,</li> <li>– is not identified by the registration certificate as being the vehicle owner.</li> </ul>	N
Data relating to owners of the vehicle		(C.2)	
Owners' (company) name	M	(C.2.1)	Y
First name	M	(C.2.2)	Y
Address	M	(C.2.3)	Y
Gender	M	male, female	Y
Date of birth	M		Y
Legal entity	M	individual, association, company, firm, etc.	Y
Place of Birth	O		Y
ID Number	O	An identifier that uniquely identifies the person or the	N

		company.	
Type of ID Number	O	The type of ID Number (e.g. passport number).	N
Start date ownership	O	Start date of the ownership of the car.	N
End date ownership	O	End data of the ownership of the car.	N
Data relating to vehicles			
Licence number	M		Y
Chassis number/VIN	M		Y
Country of registration	M		Y
Make	M	(D.1) e.g. Ford, Opel, Renault, etc.	Y
Commercial type of the vehicle	M	(D.3) e.g. Focus, Astra, Megane.	Y
Nature of the vehicle/EU Category Code	M	(J) mopeds, motorbikes, cars, etc.	Y
Date of first registration	M	(B) Date of first registration of the vehicle somewhere in the world.	Y
Start date (actual) registration	M	(I) Date of the registration to which the specific certificate of the vehicle refers.	Y
End date registration	M	End data of the registration to which the specific certificate of the vehicle refers. It is possible this date indicates the period of validity as printed on the document if not unlimited (document abbreviation = H).	Y
Status	M	Scrapped, stolen, exported, etc.	Y
Start date status	M		Y
End date status	O		N

kW	O	(P.2)	Y
Capacity	O	(P.1)	Y
Type of licence number	O	Regular, transito, etc.	Y
Vehicle document id 1	O	The first unique document ID as printed on the vehicle document.	Y
Vehicle document id 2 <sup>154</sup>	O	A second document ID as printed on the vehicle document.	Y
Data relating to insurances			
Insurance company name	O		Y
Begin date insurance	O		Y
End date insurance	O		Y
Address	O		Y
Insurance number	O		Y
ID number	O	An identifier that uniquely identifies the company.	N
Type of ID number	O	The type of ID number (e.g. number of the Chamber of Commerce)	N

## 2. Data Security

### 2.1. Overview

The Eucaris software application handles secure communication to the other States and communicates to the back-end legacy systems of States using XML. States exchange messages by directly sending them to the recipient. The data centre of a State is connected to the TESTA network.

---

<sup>154</sup> In Luxembourg two separate vehicle registration document ID's are used.

The XML-messages sent over the network are encrypted. The technique to encrypt these messages is SSL. The messages sent to the back-end are plain text XML-messages since the connection between the application and the back-end shall be in a protected environment.

A client application is provided which can be used within a State to query their own register or other States' registers. The clients will be identified by means of user-id/password or a client certificate. The connection to a user may be encrypted, but this is the responsibility of each individual State.

## 2.2. Security Features related to message exchange

The security design is based on a combination of HTTPS and XML signature. This alternative uses XML-signature to sign all messages sent so the server and can authenticate the sender of the message by checking the signature. 1-sided SSL (only a server certificate) is used to protect the confidentiality and integrity of the message in transit and provides protection against deletion/replay and insertion attacks. Instead of bespoke software development to implement 2-sided SSL, XML-signature is implemented. Using XML-signature is closer to the web services roadmap than 2-sided SSL and therefore more strategic.

The XML-signature can be implemented in several ways but the chosen approach is to use XML Signature as part of the Web Services Security (WSS). WSS specifies how to use XML-signature. Since WSS builds upon the SOAP standard, it is logical to adhere to the SOAP standard as much as possible.

## 2.3. Security features not related to message exchange

### 2.3.1. Authentication of users

The users of the Eucaris web application authenticate themselves using a username and password. Since standard Windows authentication is used, States can enhance the level of authentication of users if needed by using client certificates.

### 2.3.2. User roles

The Eucaris software application supports different user roles. Each cluster of services has its own authorisation. E.g. (exclusive) users of the "Treaty of Eucaris" — functionality' may not use the "Prüm" — functionality'. Administrator services are separated from the regular end-user roles.

### 2.3.3. Logging and tracing of message exchange

Logging of all message types is facilitated by the Eucaris software application. An administrator function allows the national administrator to determine which messages are logged: requests from end-users, incoming requests from other States, provided information from the national registers, etc.

The application can be configured to use an internal database for this logging, or an external (Oracle) database. The decision on what messages have to be logged clearly depends on logging facilities elsewhere in the legacy systems and connected client applications.

The header of each message contains information on the requesting State, the requesting organisation within that State and the user involved. Also the reason of the request is indicated.



By means of the combined logging in the requesting and responding State complete tracing of any message exchange is possible (e.g. on request of a citizen involved).

Logging is configured through the Eucaris web client (menu Administration, Logging configuration). The logging functionality is performed by the Core System. When logging is enabled, the complete message (header and body) is stored in one logging record. Per defined service, and per message type that passes along the Core System, the logging level can be set.

#### Logging Levels

The following logging levels are possible:

Private — Message is logged: The logging is NOT available to the extract logging service but is available on a national level only, for audits and problem solving.

None — Message is not logged at all.

#### Message Types

Information exchange between States consists of several messages, of which a schematic representation is given in Figure 5 below.

The possible message types (in Figure 5 shown for the Eucaris Core System of State X) are the following:

1. Request to Core System\_Request message by Client;
2. Request to Other State\_Request message by Core System of this State;
3. Request to Core System of this State\_Request message by Core System of other State;
4. Request to Legacy Register\_Request message by Core System;
5. Request to Core System\_Request message by Legacy Register;
6. Response from Core System\_Request message by Client;
7. Response from Other State\_Request message by Core System of this State;
8. Response from Core System of this State\_Request message by other State;
9. Response from Legacy Register\_Request message by Core System;
10. Response from Core System\_Request message by Legacy Register.

The following information exchanges are shown in Figure 5:

- \* Information request from State X to State Y — blue arrows. This request and response consists of message types 1, 2, 7 and 6, respectively;

- \* Information request from State Z to State X — red arrows. This request and response consists of message types 3, 4, 9 and 8, respectively;
- \* Information request from the legacy register to its core system (this route also includes a request from a custom client behind the legacy register) — green arrows. This kind of request consists of message types 5 and 10.

*Figure 5: Message types for logging*

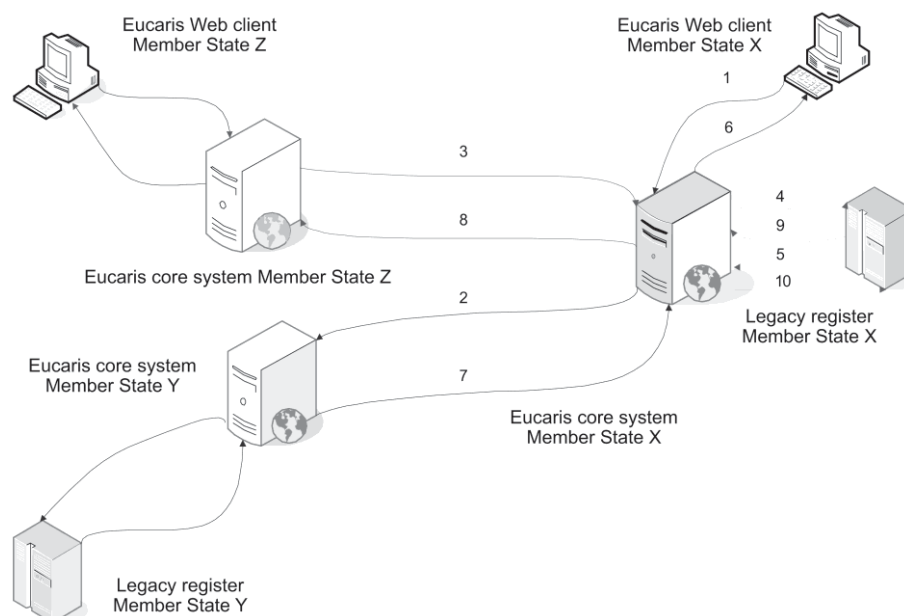

#### 2.3.4. Hardware Security Module

A Hardware Security Module is not used.

A Hardware Security Module (HSM) provides good protection for the key used to sign messages and to identify servers. This adds to the overall level of security but an HSM is expensive to buy/maintain and there are no requirements to decide for a FIPS 140-2 level 2 or level 3 HSM. Since a closed network is used that mitigates threats effectively, it is decided not to use an HSM initially. If an HSM is necessary e.g. to obtain accreditation, it can be added to the architecture.

### 3. Technical conditions of the data exchange

#### 3.1. General description of the Eucaris application

##### 3.1.1. Overview

The Eucaris application connects all participating States in a mesh network where each State communicates directly to another State. There is no central component needed for the communication to be established. The Eucaris application handles secure communication to the other States and communicates to the back-end legacy systems of States using XML. The following picture visualises this architecture.

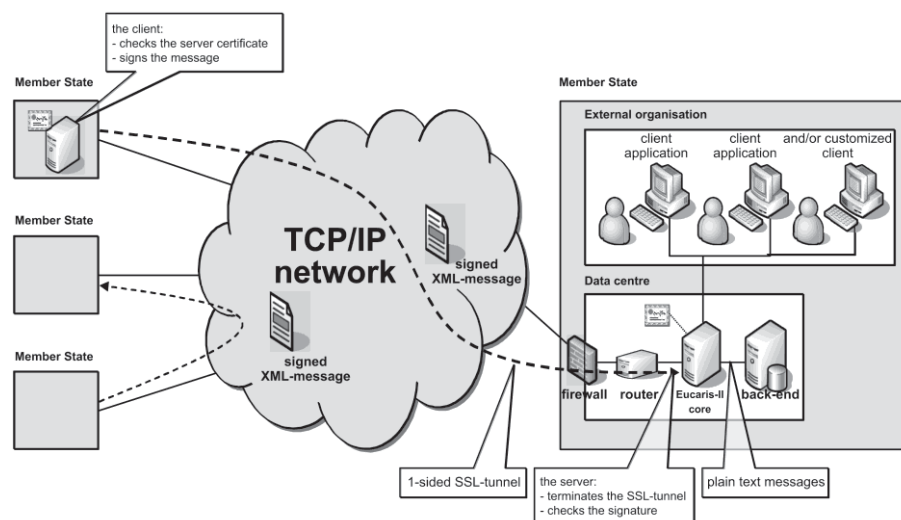

States exchange messages by directly sending them to the recipient. The data centre of a State is connected to the network used for the message exchange (TESTA). To access the TESTA network, States connect to TESTA via their national gate. A firewall shall be used to connect to the network and a router connects the Eucaris application to the firewall. Depending on the alternative chosen to protect the messages, a certificate is used either by the router or by the Eucaris application.

A client application is provided which can be used within a State to query its own register or other States' registers. The client application connects to Eucaris. The clients will be identified by means of user-id/password or a client certificate. The connection to a user in an external organisation (e.g. police) may be encrypted but this is the responsibility of each individual State.

### 3.1.2. Scope of the system

The scope of the Eucaris system is limited to the processes involved in the exchange of information between the Registration Authorities in the States and a basic presentation of this information. Procedures and automated processes in which the information is to be used, are outside the scope of the system.

States can choose either to use the Eucaris client functionality or to set up their own customised client application. The table below describes which aspects of the Eucaris system are mandatory to use and/or prescribed and which are optional to use and/or free to determine by the States.

Eucaris aspects	M/O 155	Remark
Network concept	M	The concept is an 'any-to-any' communication.
Physical	M	TESTA

155

M = mandatory to use or to comply with O = optional to use or to comply with.

network		
Core application	M	<p>The core application of Eucaris has to be used to connect to the other States. The following functionality is offered by the core:</p> <ul style="list-style-type: none"> <li>* Encrypting and signing of the messages;</li> <li>* Checking of the identity of the sender;</li> <li>* Authorisation of States and local users;</li> <li>* Routing of messages;</li> <li>* Queuing of asynchronous messages if the recipient service is temporally unavailable;</li> <li>* Multiple country inquiry functionality;</li> <li>* Logging of the exchange of messages;</li> <li>* Storage of incoming messages</li> </ul>
Client application	O	In addition to the core application the Eucaris II client application can be used by a State. When applicable, the core and client application are modified under auspices of the Eucaris organisation.
Security concept	M	The concept is based on XML-signing by means of client certificates and SSL-encryption by means of service certificates.
Message specifications	M	Every State has to comply with the message specifications as set by the Eucaris organisation and this Chapter. The specifications can only be changed by the Eucaris organisation in consultation with the States.
Operation and Support	M	The acceptance of new States or a new functionality is under auspices of the Eucaris organisation. Monitoring and help desk functions are managed centrally by an appointed State.

### 3.2. Functional and Non-Functional Requirements

#### 3.2.1. *Generic functionality*

In this section the main generic functions have been described in general terms.

No	Description

1.	The system allows the Registration Authorities of the States to exchange request and response messages in an interactive way.
2.	The system contains a client application, enabling end-users to send their requests and presenting the response information for manual processing.
3.	The system facilitates ‘broadcasting’, allowing a State to send a request to all other States. The incoming responses are consolidated by the core application in one response message to the client application (this functionality is called a "Multiple Country Inquiry").
4.	The system is able to deal with different types of messages. User roles, authorisation, routing, signing and logging are all defined per specific service.
5.	The system allows the States to exchange batches of messages or messages containing a large number of requests or replies. These messages are dealt with in an asynchronous way.
6.	The system queues asynchronous messages if the recipient State is temporarily unavailable and guarantees the deliverance as soon as the recipient is up again.
7.	The system stores incoming asynchronous messages until they can be processed.
8.	The system only gives access to Eucaris applications of other States, not to individual organisations within those other States, i.e. each Registration Authority acts as the single gateway between its national end-users and the corresponding Authorities in the other States.
9.	It is possible to define users of different States on one Eucaris server and to authorise them following the rights of that State.
10.	Information on the requesting State, organisation and end user are included in the messages.
11.	The system facilitates logging of the exchange of messages between the different States and between the core application and the national registration systems.
12.	The system allows a specific secretary, which is an organisation or State explicitly appointed for this task, to gather logged information on messages sent/received by all the participating States, in order to produce statistical reports.
13.	Each State indicates itself what logged information is made available for the secretary and what information is ‘private’.
14.	The system allows the National Administrators of each State to extract statistics of use.
15.	The system enables addition of new States through simple administrative tasks.

### 3.2.2. Usability

No	Description
16.	The system provides an interface for automated processing of messages by back-end systems/legacy and enables the integration of the user interface in those systems (customised user-interface).
17.	The system is easy to learn, self-explanatory and contains help-text.
18.	The system is documented to assist States in integration, operational activities and future maintenance (e.g. reference guides, functional/technical documentation, operational guide, ...).
19.	The user interface is multi-lingual and offers facilities for the end-user to select a preferred language.
20.	The user interface contains facilities for a Local Administrator to translate both screen-items and coded information to the national language.

### 3.2.3. Reliability

No	Description
21.	The system is designed as a robust and dependable operational system which is tolerant to operator errors and which will recover cleanly from power cuts or other disasters. It shall be possible to restart the system with no or minimal loss of data.
22.	The system shall give stable and reproducible results.
23.	The system has been designed to function reliably. It is possible to implement the system in a configuration that guarantees an availability of 98 % (by redundancy, the use of back-up servers, etc.) in each bilateral communication.
24.	It is possible to use part of the system, even during failure of some components (if State C is down, States A and B are still able to communicate). The number of single points of failure in the information chain should be minimised.
25.	The recovery time after a severe failure should be less than one day. It should be possible to minimise down-time by using remote support, e.g. by a central service desk.

#### 3.2.4. Performance

No	Description
26.	The system can be used 24x7. This time-window (24x7) is then also required from the States' legacy systems.
27.	The system responds rapidly to user requests irrespective of any background tasks. This is also required from the Parties legacy systems to ensure acceptable response time. An overall response time of 10 seconds maximum for a single request is acceptable.
28.	The system has been designed as a multi-user system and in such a way that background tasks can continue while the user performs foreground tasks.
29.	The system has been designed to be scaleable in order to support the potential increase of number of messages when new functionality is added or new organisations or States are added.

#### 3.2.5. Security

No	Description
30.	The system is suited (e.g. in its security measures) for the exchange of messages containing privacy-sensitive personal data (e.g. car owner/holders), classified as EU restricted.
31.	The system is maintained in such a way that unauthorised access to the data is prevented.
32.	The system contains a service for the management of the rights and permissions of national end-users.
33.	States are able to check the identity of the sender (at State level), by means of XML-signing.
34.	States shall explicitly authorise other States to request specific information.
35.	The system provides at application level a full security and encryption policy compatible with the level of security required in such situations. Exclusiveness and integrity of the information is guaranteed by the use of XML-signing and encryption by means of SSL-tunnelling.
36.	All exchange of messages can be traced by means of logging.
37.	Protection is provided against deletion attacks (a third party deletes a message) and replay or insertion attacks (a third party replays or inserts a message).

38.	The system makes use of certificates of a Trusted Third Party (TTP).
39.	The system is able to handle different certificates per State, depending on the type of message or service.
40.	The security measures at application level are sufficient to allow the use of non-accredited networks.
41.	The system is able to use novice security techniques such as an XML-firewall.

### 3.2.6. *Adaptability*

No	Description
42.	The system is extensible with new messages and new functionality. The costs of adaptations are minimal. Due to the centralised development of application components.
43.	States are able to define new message types for bilateral use. Not all States are required to support all message types.

### 3.2.7. *Support and Maintenance*

No	Description
44.	The system provides monitoring facilities for a central service-desk and/or operators concerning the network and servers in the different States.
45.	The system provides facilities for remote support by a central service-desk.
46.	The system provides facilities for problem analysis.
47.	The system can be expanded to new States.
48.	The application can easily be installed by staff with a minimum of IT-qualifications and experience. The installation procedure shall be as much as possible automated.
49.	The system provides a permanent testing and acceptance environment.
50.	The annual costs of maintenance and support has been minimised by adherence to market standards and by creating the application in such a way that as little support as possible from a central service-desk is required.



### 3.2.8. Design requirements

No	Description
51.	The system is designed and documented for an operational lifetime of many years.
52.	The system has been designed in such a way that it is independent of the network provider.
53.	The system is compliant with the existing HW/SW in the States by interacting with those registration systems using open standard web service technology (XML, XSD, SOAP, WSDL, HTTP(s), Web services, WSS, X.509, etc.).

### 3.2.9. Applicable standards

No	Description
54.	The system is compliant with data protection issues as stated in Regulation EC 45/2001 (Articles 21, 22 and 23) and Directive 95/46/EC.
55.	The system complies with the IDA Standards.
56.	The system supports UTF8.

## CHAPTER 4: Evaluation procedure according to Article LAW.PRUM.18 [Ex ante evaluation]

### Article 1: Questionnaire

1. The relevant Working Group of the Council of the European Union (the “Council Working Group”) shall draw up a questionnaire concerning each of the automated data exchanges set out in Articles LAW.PRUM.5 [Objective] to LAW.PRUM.17 [Implementing measures].
2. As soon as the United Kingdom considers that it fulfils the prerequisites for sharing data in the relevant data category, it shall answer the relevant questionnaire.

### Article 2: Pilot run

1. If required, and with a view to evaluating the results of the questionnaire, the United Kingdom shall carry out a pilot run together with one or more other Member States already sharing data under Decision 2008/615/JHA. The pilot run takes place shortly before or shortly after the evaluation visit.
2. The conditions and arrangements for this pilot run shall be identified by the relevant Council Working Group and be based upon prior individual agreement with the United Kingdom. The States taking part in the pilot run shall decide on the practical details.

### Article 3: Evaluation visit

1. With a view to evaluating the results of the questionnaire, an evaluation visit shall take place.
2. The conditions and arrangement for this visit shall be identified by the relevant Council Working Group and be based upon prior individual agreement between the United Kingdom and the evaluation team. The United Kingdom shall enable the evaluation team to check the automated exchange of data in the data category or categories to be evaluated, in particular by organising a programme for the visit, which takes into account the requests of the evaluation team.
3. Within one month of the visit, the evaluation team shall produce a report on the evaluation visit and shall forward it to the United Kingdom for its comments. If appropriate, this report may be revised by the evaluation team on the basis of the United Kingdom's comments.
4. The evaluation team shall consist of no more than three experts, designated by the Member States taking part in the automated data exchange in the data categories to be evaluated, who have experience regarding the concerned data category, have the appropriate national security clearance to deal with these matters and are willing to take part in at least one evaluation visit in another State. The evaluation team shall also include a representative of the Commission.
5. The members of the evaluation team shall respect the confidential nature of the information they acquire when carrying out their task.

### Article 4: Evaluations carried out under Council Decisions 2008/615/JHA and 2008/616/JHA

When carrying out the evaluation procedure as referred to in Article LAW.PRUM.18 [Ex ante evaluation] and this Chapter, the Council, through the relevant Council Working Group, will take into account the results of the evaluation procedures, carried out in the context of the adoption of Council Implementing Decisions (EU) 2019/968<sup>156</sup> and (EU) 2020/1188<sup>157</sup>. The relevant Council Working Group will decide on the necessity of carrying out the pilot run referred to in Article LAW.PRUM.18(1) [Ex ante evaluation], in Article 23(2) of Chapter 0 of this Annex, and in Article 2 of this Chapter.

### Article 5: Report to the Council

An overall evaluation report, summarising the results of the questionnaires, the evaluation visit and, where applicable, the pilot run, shall be presented to the Council for its decision pursuant to Article LAW.PRUM.18 [Ex ante evaluation].

---

<sup>156</sup> Council Implementing Decision (EU) 2019/968 of 6 June 2019 on the launch of automated data exchange with regard to DNA data in the United Kingdom (OJ L 156, 13.6.2019, p. 8).

<sup>157</sup> Council Implementing Decision (EU) 2020/1188 of 6 August 2020 on the launch of automated data exchange with regard to dactyloscopic data in the United Kingdom (OJ L 265, 12.8.2020, p. 1).

## **ANNEX LAW-2: PASSENGER NAME RECORD DATA**

### **Passenger name record data elements (as far as collected by air carriers):**

1. PNR record locator;
2. Date of reservation/issue of ticket;
3. Date or dates of intended travel;
4. Name or names;
5. Address, telephone number and electronic contact information of the passenger, the persons who made the flight reservation for the passenger, persons through whom an air passenger may be contacted and persons who are to be informed in the event of an emergency;
6. All available payment/billing information (covering information relating solely to the payment methods for, and billing of, the air ticket, to the exclusion of any other information not directly relating to the flight);
7. Complete travel itinerary for specific PNR;
8. Frequent flyer information (the designator of the airline or vendor that administers the program, frequent flyer traveller number, membership level, tier description and alliance code);
9. Travel agency/travel agent;
10. Travel status of passenger, including confirmations, check-in status, no-show or go-show information;
11. Split/divided PNR information;
12. Other Supplementary Information (OSI), Special Service Information (SSI) and Special Service Request (SSR) information;
13. Ticketing field information, including ticket number, date of ticket issuance and one-way tickets, automated ticket fare quote fields;
14. Seat information, including seat number;
15. Code share information;
16. All baggage information;
17. The names of other passengers on the PNR and number of passengers on the PNR travelling together;
18. Any advance passenger information (API) data collected (type, number, country of issuance and expiry date of any identity document, nationality, family name, given name, gender, date of birth, airline, flight number, departure date, arrival date, departure port, arrival port, departure time and arrival time);

19. All historical changes to the PNR listed in points 1 to 18.

**ANNEX LAW-3: FORMS OF CRIME FOR WHICH EUROPOL IS COMPETENT**

- Terrorism,
- Organised crime,
- Drug trafficking,
- Money-laundering activities,
- Crime connected with nuclear and radioactive substances,
- Immigrant smuggling,
- Trafficking in human beings,
- Motor vehicle crime,
- Murder and grievous bodily injury,
- Illicit trade in human organs and tissue,
- Kidnapping, illegal restraint and hostage-taking,
- Racism and xenophobia,
- Robbery and aggravated theft,
- Illicit trafficking in cultural goods, including antiquities and works of art,
- Swindling and fraud,
- Crime against the financial interests of the Union,
- Insider dealing and financial market manipulation,
- Racketeering and extortion,
- Counterfeiting and product piracy,
- Forgery of administrative documents and trafficking therein,
- Forgery of money and means of payment,
- Computer crime,
- Corruption,
- Illicit trafficking in arms, ammunition and explosives,

- Illicit trafficking in endangered animal species,
- Illicit trafficking in endangered plant species and varieties,
- Environmental crime, including ship-source pollution,
- Illicit trafficking in hormonal substances and other growth promoters,
- Sexual abuse and sexual exploitation, including child abuse material and solicitation of children for sexual purposes,
- Genocide, crimes against humanity and war crimes.

**ANNEX LAW-4: FORMS OF SERIOUS CRIME FOR WHICH EUROJUST IS COMPETENT**

- Terrorism,
- Organised crime,
- Drug trafficking,
- Money-laundering activities,
- Crime connected with nuclear and radioactive substances,
- Immigrant smuggling,
- Trafficking in human beings,
- Motor vehicle crime,
- Murder and grievous bodily injury,
- Illicit trade in human organs and tissue,
- Kidnapping, illegal restraint and hostage taking,
- Racism and xenophobia,
- Robbery and aggravated theft,
- Illicit trafficking in cultural goods, including antiquities and works of art,
- Swindling and fraud,
- Crime against the financial interests of the Union,
- Insider dealing and financial market manipulation,
- Racketeering and extortion,
- Counterfeiting and product piracy,
- Forgery of administrative documents and trafficking therein,
- Forgery of money and means of payment,
- Computer crime,
- Corruption,
- Illicit trafficking in arms, ammunition and explosives,

- Illicit trafficking in endangered animal species,
- Illicit trafficking in endangered plant species and varieties,
- Environmental crime, including ship source pollution,
- Illicit trafficking in hormonal substances and other growth promoters,
- Sexual abuse and sexual exploitation, including child abuse material and solicitation of children for sexual purposes,
- Genocide, crimes against humanity and war crimes.



#### ANNEX LAW-5: ARREST WARRANT

This warrant has been issued by a competent judicial authority. I request that the person mentioned below be arrested and surrendered for the purposes of conducting a criminal prosecution or executing a custodial sentence or detention order.<sup>158</sup>

(a) Information regarding the identity of the requested person:

Name:

Forename(s):

Maiden name, where applicable:

Aliases, where applicable:

Sex:

Nationality:

Date of birth:

Place of birth:

Residence and/or known address:

Language(s) which the requested person understands (if known):

Distinctive marks/description of the requested person:

Photo and fingerprints of the requested person, if they are available and can be transmitted, or contact details of the person to be contacted in order to obtain such information or a DNA profile (where this evidence can be supplied but has not been included)

(b) Decision on which the warrant is based:

1. Arrest warrant or judicial decision having the same effect:

<sup>158</sup> This warrant must be written in, or translated into, one of the official languages of the executing State, when that State is known, or any other language accepted by that State.

Type:	
2. Enforceable judgement:	
Reference:	

(c) Indications on the length of the sentence:	
1. Maximum length of the custodial sentence or detention order which may be imposed for the offence(s):	
2. Length of the custodial sentence or detention order imposed:	
Remaining sentence to be served:	

(d) Indicate if the person appeared in person at the trial resulting in the decision:	
1.	<input type="checkbox"/> Yes, the person appeared in person at the trial resulting in the decision.
2.	<input type="checkbox"/> No, the person did not appear in person at the trial resulting in the decision.
3.	If you have ticked the box under point 2, please confirm the existence of one of the following, if applicable:
	<input type="checkbox"/> 3.1a. the person was summoned in person on ... (day/month/year) and thereby informed of the scheduled date and place of the trial which resulted in the decision and was informed that a decision may be handed down if he or she does not appear for the trial;
	OR
	<input type="checkbox"/> 3.1b. the person was not summoned in person but by other means actually received official information of the scheduled date and place of the trial which resulted in the decision, in such a manner that it was unequivocally established that he or she was aware of the scheduled trial, and was informed that a decision may be handed down if he or she does not appear for the trial;

OR

- 3.2. being aware of the scheduled trial, the person had given a mandate to a legal counsellor, who was either appointed by the person concerned or by the State, to defend him or her at the trial, and was indeed defended by that counsellor at the trial;

OR

- 3.3. the person was served with the decision on ... (day/month/year) and was expressly informed about the right to a retrial or appeal, in which he or she has the right to participate and which allows the merits of the case, including fresh evidence, to be re-examined, and which may lead to the original decision being reversed, and

- the person expressly stated that he or she does not contest this decision;

OR

- the person did not request a retrial or appeal within the applicable timeframe;

OR

- 3.4. the person was not personally served with the decision, but
- the person will be personally served with this decision without delay after the surrender; and
  - when served with the decision, the person will be expressly informed of his or her right to a retrial or appeal, in which he or she has the right to participate and which allows the merits of the case, including fresh evidence, to be re-examined, and which may lead to the original decision being reversed; and
  - the person will be informed of the timeframe within which he or she has to request a retrial or appeal, which will be ..... days.

4. If you have ticked the box under point 3.1b, 3.2 or 3.3 above, please provide information about how the relevant condition has been met:

.....  
.....

(e) Offences:

This warrant relates to in total:   offences

Description of the circumstances in which the offence(s) was (were) committed, including the time, place and degree of participation in the offence(s) by the requested person:

Nature and legal classification of the offence(s) and the applicable statutory provision/code:

I. The following applies only in case both the issuing and the executing State have made a notification under Article LAW.SURR.79(4) [Scope] of the Agreement: if applicable, tick one or more of the following offences, as defined by the law of the issuing State, punishable in the issuing State by a custodial sentence or detention order for a maximum period of at least three years:

- participation in a criminal organisation,
- terrorism as defined in Annex LAW-7 of the Agreement,
- trafficking in human beings,
- sexual exploitation of children and child pornography,
- illicit trafficking in narcotic drugs and psychotropic substances,
- illicit trafficking in weapons, munitions and explosives,
- corruption, including bribery,
- fraud, including that affecting the financial interests of the United Kingdom, of a Member State or of the Union,
- laundering of the proceeds of crime,
- counterfeiting of currency,
- computer-related crime,
- environmental crime, including illicit trafficking in endangered animal species and in

endangered plant species and varieties,

- facilitation of unauthorised entry and residence,
- murder, grievous bodily injury,
- illicit trade in human organs and tissue,
- kidnapping, illegal restraint and hostage-taking,
- racism and xenophobia,
- organised or armed robbery,
- illicit trafficking in cultural goods, including antiques and works of art,
- swindling,
- racketeering and extortion,
- counterfeiting and piracy of products,
- forgery of administrative documents and trafficking therein,
- forgery of means of payment,
- illicit trafficking in hormonal substances and other growth promoters,
- illicit trafficking in nuclear or radioactive materials,
- trafficking in stolen vehicles,
- rape,
- arson,
- crimes within the jurisdiction of the International Criminal Court,
- unlawful seizure of aircraft, ships or spacecraft,
- sabotage.

II. Full descriptions of offence(s) not covered by section I above:

(f) Other circumstances relevant to the case (optional information):  
(NB: This could cover remarks on extraterritoriality, interruption of periods of time limitation and other consequences of the offence)

(g) This warrant pertains also to the seizure and handing over of property which may be required as evidence:

This warrant pertains also to the seizure and handing over of property acquired by the requested person as a result of the offence:

Description of the property (and location) (if known):

(h) The offence(s) on the basis of which this warrant has been issued is (are) punishable by/has(have) led to a custodial life sentence or lifetime detention order:

the issuing State will upon request by the executing State give an assurance that it will:

review the penalty or measure imposed – on request or at least after 20 years, and/or

encourage the application of measures of clemency to which the person is entitled to apply for under the law or practice of the issuing State, aiming at a non-execution of such penalty

or measure.

(i) The judicial authority which issued the warrant:

Official name:

Name of its representative:<sup>1</sup>

Post held (title/grade):

File reference:

Address:

Tel. No.: (country code) (area/city code)

Fax No. (country code) (area/city code)

E-mail:

Contact details of the person to contact to make necessary practical arrangements for the surrender:

Where a central authority has been made responsible for the transmission and administrative reception of arrest warrants:

Name of the central authority:

Contact person, if applicable (title/grade and name):

Address:

Tel. No.: (country code) (area/city code)

Fax No. (country code) (area/city code)

---

<sup>1</sup> In the different language versions a reference to the "holder" of the judicial authority will be included.

E-mail:	
Signature of the issuing judicial authority and/or its representative:	
Name:	
Post held (title/grade):	
Date:	
Official stamp (if available):	



## **ANNEX LAW-6: EXCHANGE OF CRIMINAL RECORD INFORMATION – TECHNICAL AND PROCEDURAL SPECIFICATIONS**

### **CHAPTER 1– GENERAL PROVISIONS**

#### **Article 1: Objective**

The objective of this Annex is to lay down the necessary procedural and technical provisions for the implementation of Title IX [Exchange of criminal record information] of Part Three.

#### **Article 2: Communications network**

1. The electronic exchange of information extracted from the criminal record between, on the one side, a Member State and, on the other side, the United Kingdom shall take place using a common communication infrastructure that provides for encrypted communications.
2. The common communication infrastructure shall be the Trans European Services for Telematics between Administrations (TESTA) communications network. Any further developments thereof or any alternative secure network shall ensure that the common communication infrastructure in place continues to fulfil the security requirements adequate for the exchange of criminal record information.

#### **Article 3: Interconnection software**

1. The States shall use a standardised interconnection software enabling the connection of their central authorities to the common communication infrastructure in order to exchange the information extracted from the criminal record with the other States electronically in accordance with the provisions of Title IX [Exchange of criminal record information] of Part Three and this Annex.
2. For the Member States, the interconnection software shall be the ECRIS reference implementation software or their national ECRIS implementation software, if necessary adapted for the purposes of information exchange with the United Kingdom as set out in this Agreement.
3. The United Kingdom shall be responsible for the development and operation of its own interconnection software. For that purpose, at the latest before the entry into force of this Agreement, the United Kingdom shall ensure that its national interconnection software functions in accordance with the protocols and technical specifications established for the ECRIS reference implementation software, and with any further technical requirements established by eu-LISA.
4. The United Kingdom shall also ensure the implementation of any subsequent technical adaptations to its national interconnection software required by any changes to the technical specifications established for the ECRIS reference implementation software, or changes to any further technical requirements established by eu-LISA, without undue delay. To that end, the Union shall ensure that the United Kingdom is informed without undue delay of any planned changes to the technical specifications or requirements and is provided with any information necessary for the United Kingdom to comply with its obligations under this Annex.

#### **Article 4: Information to be transmitted in notifications, requests and replies**

1. All notifications referred to in Article LAW.EXINF.123 [Notifications] shall include the following obligatory information:
  - (a) information on the convicted person (full name, date of birth, place of birth (town and State), gender, nationality and – if applicable – previous name(s));

- (b) information on the nature of the conviction (date of conviction, name of the court, date on which the decision became final);
- (c) information on the offence giving rise to the conviction (date of the offence underlying the conviction and name or legal classification of the offence as well as reference to the applicable legal provisions); and
- (d) information on the contents of the conviction (notably the sentence as well as any supplementary penalties, security measures and subsequent decisions modifying the enforcement of the sentence).

2. The following optional information shall be transmitted in notifications if that information has been entered in the criminal record (points (a) to (d)) or is available to the central authority (points (e) to (h)):

- (a) the convicted person's parents' names;
- (b) the reference number of the conviction;
- (c) the place of the offence;
- (d) disqualifications arising from the conviction;
- (e) the convicted person's identity number, or the type and number of the person's identification document;
- (f) fingerprints, which have been taken from that person;
- (g) if applicable, pseudonym and/or alias(es);
- (h) facial image.

In addition, any other information concerning convictions entered in the criminal record may be transmitted.

3. All requests for information referred to in Article LAW.EXINF.125 [Requests for information] shall be submitted in a standardised electronic format according to the model form set out in Chapter 2 [FORMS] of this Annex, in one of the official languages of the requested State.

4. All replies to requests referred to in Article LAW.EXINF.126 [Replies to requests] shall be submitted in a standardised electronic format in accordance with the model form set out in Chapter 2 [FORMS] of this Annex, and accompanied by a list of convictions, as provided for by national law. The requested State shall reply either in one of its official languages or in any other language accepted by both Parties. The United Kingdom, on the one side, and the Union, on behalf of any of its Member States, on the other side, may notify to the Specialised Committee on Law Enforcement and Judicial Cooperation which language(s) it accepts in addition to the official language(s) of that State.

5. The Specialised Committee on Law Enforcement and Judicial Cooperation shall adopt any modifications to the forms in Chapter 2 [FORMS] of this Annex referred to in paragraphs 3 and 4 as may be necessary.

#### Article 5: Format of transmission of information

1. When transmitting information in accordance with Article LAW.EXINF.123 [Notifications] and Article LAW.EXINF.126 [Replies to requests] relating to the name or legal classification of the offence and to the applicable legal provisions, the States shall refer to the corresponding code for each of the offences referred to in the transmission, as provided for in the table of offences in Chapter 3 [STANDARDISED FORMAT OF TRANSMISSION OF INFORMATION] of this Annex. By way of

exception, if the offence does not correspond to any specific sub-category, the 'open category' code of the relevant or closest category of offences or, in the absence of the latter, an 'other offences' code, shall be used for that particular offence.

2. The States may also provide available information relating to the level of completion and the level of participation in the offence and, if applicable, to the existence of total or partial exemption from criminal responsibility, or to recidivism.

3. When transmitting information in accordance with Article LAW.EXINF.123 [Notifications] and Article LAW.EXINF.126 [Replies to requests] relating to the contents of the conviction, notably the sentence as well as any supplementary penalties, security measures and subsequent decisions modifying the enforcement of the sentence, the States shall refer to the corresponding code for each of the penalties and measures referred to in the transmission, as provided for in the table of penalties and measures in Chapter 3 [STANDARISED FORMAT OF TRANSMISSION OF INFORMATION] of this Annex. By way of exception, if the penalty or measure does not correspond to any specific sub-category, the 'open category' code of the relevant or closest category of penalties and measures or, in the absence of the latter, an 'other penalties and measures' code, shall be used for that particular penalty or measure.

4. The States shall also provide, if applicable, available information relating to the nature and/or conditions of execution of the penalty or measure imposed as provided for in the table of parameters of Chapter 3 [STANDARISED FORMAT OF TRANSMISSION OF INFORMATION] of this Annex. The parameter 'non-criminal ruling' shall be indicated only in cases where information on such a ruling is provided on a voluntary basis by the State of nationality of the person concerned, when replying to a request for information on convictions.

5. The following information shall be provided by the States to the Specialised Committee on Law Enforcement and Judicial Cooperation, with a view in particular to disseminating this information to other States:

- (a) the list of national offences in each of the categories referred to in the table of offences in Chapter 3 [STANDARISED FORMAT OF TRANSMISSION OF INFORMATION] of this Annex. The list shall include the name or legal classification of the offence and reference to the applicable legal provisions. It may also include a short description of the constitutive elements of the offence;
- (b) the list of types of sentences, possible supplementary penalties and security measures and possible subsequent decisions modifying the enforcement of the sentence as defined in national law, in each of the categories referred to in the table of penalties and measures in Chapter 3 [STANDARISED FORMAT OF TRANSMISSION OF INFORMATION] of this Annex. It may also include a short description of the specific penalty or measure.

6. The lists and descriptions referred to in paragraph 5 shall be regularly updated by the States. Updated information shall be sent to the Specialised Committee on Law Enforcement and Judicial Cooperation.

7. The Specialised Committee on Law Enforcement and Judicial Cooperation shall adopt any modifications to the tables in Chapter 3 [STANDARISED FORMAT OF TRANSMISSION OF INFORMATION] of this Annex referred to in paragraphs 1 to 4 as may be necessary.

#### Article 6: Continuity of transmission

If the electronic mode of transmission of information is temporarily not available, the States shall transmit information by any means capable of producing a written record under conditions allowing

the central authority of the requested State to establish the authenticity thereof, for the entire period of such unavailability.

#### Article 7: Statistics and reporting

1. An evaluation of the electronic exchange of information extracted from criminal records pursuant to Title IX [Exchange of criminal record information] of Part Three shall be carried out on a regular basis. The evaluation shall be based on the statistics and reports of the respective States.
2. Each State shall compile statistics on the exchange generated by the interconnection software and shall forward them every month to the Specialised Committee on Law Enforcement and Judicial Cooperation and to eu-LISA. The States shall also provide the Specialised Committee on Law Enforcement and Judicial Cooperation and eu-LISA with the statistics on the number of nationals of other States convicted on their territory and on the number of such convictions.

#### Article 8: Technical specifications

The States shall observe common technical specifications on the electronic exchange of information extracted from the criminal record as provided by eu-LISA in the implementation of this Agreement and shall adapt their systems as appropriate without undue delay.

## CHAPTER 2– FORMS

### Request for information extracted from the criminal record

- (a) Information on the requesting State:
- State:
  - Central authority(ies):
  - Contact person:
  - Telephone (with STD code):
  - Fax (with STD code):
  - E-mail address:
  - Correspondence address:
  - File reference, if known:
- (b) Information on the identity of the person concerned by the request <sup>(1)</sup>:
- Full name (forenames and all surnames)
  - Previous names:
  - Pseudonym and/or alias, if any:
  - Gender: M  F
  - Nationality:
  - Date of birth (in figures: dd/mm/yyyy):
  - Place of birth (town and State):

Father's name:

Mother's name:

Residence or known address:

Person's identity number or type and number of the person's identification document:

Fingerprints:

Facial image :

Other available identification information:

(c) Purpose of the request:

*Please tick the appropriate box*

(1)  criminal proceedings (please identify the authority before which the proceedings are pending and, if available, the case reference number) ...

...

(2)  request outside the context of criminal proceedings (please identify the authority before which the proceedings are pending and, if available, the case reference number, while ticking the relevant box):

(i)  from a judicial authority ...

...

(ii)  from a competent administrative authority ...

...

(iii)  from the person concerned for information on own criminal record ...

...

Purpose for which the information is requested:

Requesting authority:

the person concerned does not consent for this information to be divulged (if the person concerned was asked for his or her consent in accordance with the law of the requesting State).

Contact person for any further information needed:

Name:

Telephone:

E-mail address:

Other information (e.g. urgency of the request):

### **Reply to the request**

Information relating to the person concerned

*Please tick the appropriate box*

The undersigned authority confirms that:

- there is no information on convictions in the criminal record of the person concerned
- there is information on convictions entered in the criminal record of the person concerned; a list of convictions is attached
- there is other information entered in the criminal record of the person concerned; such information is attached (optional)
- there is information on convictions entered in the criminal record of the person concerned but the convicting State intimated that the information about these convictions may not be retransmitted for any purposes other than that of criminal proceedings. The request for more information may be sent directly to ...(please indicate the convicting State)
- in accordance with the national law of the requested State, requests made for any purposes other than that of criminal proceedings may not be dealt with.

Contact person for any further information needed:

Name:

Telephone:

E-mail address:

Other information (limitations of use of the data concerning requests outside the context of criminal proceedings):

Please indicate the number of pages attached to the reply form:

Done at

on

Signature and official stamp (if appropriate):

Name and position/organisation:

If appropriate, please attach a list of convictions and send the complete package to the requesting State. It is not necessary to translate the form or the list into the language of the requesting State.

---

(<sup>1</sup>) To facilitate the identification of the person as much information as possible is to be provided.

### CHAPTER 3– STANDARDISED FORMAT OF TRANSMISSION OF INFORMATION

Common table of offences categories, with a table of parameters, referred to in Article 5(1) and (2) of Chapter 1 [Format of transmission of information]

<b>Code</b>	<b>Categories and sub-categories of offences</b>
0100 00 open category	<b>Crimes within the jurisdiction of the International Criminal Court</b>

0101 00	Genocide
0102 00	Crimes against humanity
0103 00	War crimes
0200 00 open category	<b>Participation in a criminal organisation</b>
0201 00	Directing a criminal organisation
0202 00	Knowingly taking part in the criminal activities of a criminal organisation
0203 00	Knowingly taking part in the non-criminal activities of a criminal organisation
0300 00 open category	<b>Terrorism</b>
0301 00	Directing a terrorist group
0302 00	Knowingly participating in the activities of a terrorist group
0303 00	Financing of terrorism
0304 00	Public provocation to commit a terrorist offence
0305 00	Recruitment or training for terrorism
0400 00 open category	<b>Trafficking in human beings</b>
0401 00	Trafficking in human beings for the purposes of labour or services exploitation
0402 00	Trafficking in human beings for the purposes of the exploitation of the prostitution of others or other forms of sexual exploitation
0403 00	Trafficking in human beings for the purposes of organ or human tissue removal

0404 00	Trafficking in human beings for the purposes of slavery, practices similar to slavery or servitude
0405 00	Trafficking in human beings for the purposes of labour or services exploitation of a minor
0406 00	Trafficking in human beings for the purposes of the exploitation of the prostitution of minors or other forms of their sexual exploitation
0407 00	Trafficking in human beings for the purposes of organ or human tissue removal of a minor
0408 00	Trafficking in human beings for the purposes of slavery, practices similar to slavery or servitude of a minor
0500 00 open category	<b>Illicit trafficking (1) and other offences related to weapons, firearms, their parts and components, ammunition and explosives</b>
0501 00	Illicit manufacturing of weapons, firearms, their parts and components, ammunition and explosives
0502 00	Illicit trafficking of weapons, firearms, their parts and components ammunition and explosives at national level (2)
0503 00	Illicit exportation or importation of weapons, firearms, their parts and components, ammunition and explosives
0504 00	Unauthorised possession or use of weapons, firearms, their parts and components, ammunition and explosives
0600 00 open category	<b>Environmental crime</b>
0601 00	Destroying or damaging protected fauna and flora species
0602 00	Unlawful discharges of polluting substances or ionising radiation into air, soil or water
0603 00	Offences related to waste, including hazardous waste
0604 00	Offences related to illicit trafficking (1) in protected fauna and flora species or parts



	thereof
0605 00	Unintentional environmental offences
0700 00 open category	<b>Offences related to drugs or precursors, and other offences against public health</b>
0701 00	Offences related to illicit trafficking (3) in narcotic drugs, psychotropic substances and precursors not exclusively for own personal consumption
0702 00	Illicit consumption of drugs and their acquisition, possession, manufacture or production exclusively for own personal consumption
0703 00	Aiding or inciting others to use narcotic drugs or psychotropic substances illicitly
0704 00	Manufacture or production of narcotic drugs not exclusively for personal consumption
0800 00 open category	<b>Crimes against the person</b>
0801 00	Intentional killing
0802 00	Aggravated cases of intentional killing (4)
0803 00	Unintentional killing
0804 00	Intentional killing of a new-born by his/her mother
0805 00	Illegal abortion
0806 00	Illegal euthanasia
0807 00	Offences related to committing suicide
0808 00	Violence causing death
0809 00	Causing grievous bodily injury, disfigurement or permanent disability
0810 00	Unintentionally causing grievous bodily injury, disfigurement or permanent disability

0811 00	Causing minor bodily injury
0812 00	Unintentionally causing minor bodily injury
0813 00	Exposing to danger of loss of life or grievous bodily injury
0814 00	Torture
0815 00	Failure to offer aid or assistance
0816 00	Offences related to organ or tissue removal without authorisation or consent
0817 00	Offences related to illicit trafficking (3) in human organs and tissue
0818 00	Domestic violence or threat
0900 00 open category	<b>Offences against personal liberty, dignity and other protected interests, including racism and xenophobia</b>
0901 00	Kidnapping, kidnapping for ransom, illegal restraint
0902 00	Unlawful arrest or deprivation of liberty by public authority
0903 00	Hostage-taking
0904 00	Unlawful seizure of an aircraft or ship
0905 00	Insults, slander, defamation, contempt
0906 00	Threats
0907 00	Duress, pressure, stalking, harassment or aggression of a psychological or emotional nature
0908 00	Extortion
0909 00	Aggravated extortion
0910 00	Illegal entry into private property

0911 00	Invasion of privacy other than illegal entry into private property
0912 00	Offences against protection of personal data
0913 00	Illegal interception of data or communication
0914 00	Discrimination on grounds of gender, race, sexual orientation, religion or ethnic origin
0915 00	Public incitement to racial discrimination
0916 00	Public incitement to racial hatred
0917 00	Blackmail
1000 00 open category	<b>Sexual offences</b>
1001 00	Rape
1002 00	Aggravated rape (5) other than rape of a minor
1003 00	Sexual assault
1004 00	Procuring for prostitution or sexual act
1005 00	Indecent exposure
1006 00	Sexual harassment
1007 00	Soliciting by a prostitute
1008 00	Sexual exploitation of children
1009 00	Offences related to child pornography or indecent images of minors
1010 00	Rape of a minor
1011 00	Sexual assault of a minor

1100 00 open category	<b>Offences against family law</b>
1101 00	Illicit sexual relations between close family members
1102 00	Polygamy
1103 00	Evading the alimony or maintenance obligation
1104 00	Neglect or desertion of a minor or a disabled person
1105 00	Failure to comply with an order to produce a minor or removal of a minor
1200 00 open category	<b>Offences against the State, public order, course of justice or public officials</b>
1201 00	Espionage
1202 00	High treason
1203 00	Offences related to elections and referendum
1204 00	Attempt against life or health of the Head of State
1205 00	Insult of the State, Nation or State symbols
1206 00	Insult or resistance to a representative of public authority
1207 00	Extortion, duress, pressure towards a representative of public authority
1208 00	Assault or threat on a representative of public authority
1209 00	Public order offences, breach of the public peace
1210 00	Violence during sports events
1211 00	Theft of public or administrative documents
1212 00	Obstructing or perverting the course of justice, making false allegations in the course

	of criminal or judicial proceedings, perjury
1213 00	Unlawful impersonation of a person or an authority
1214 00	Escape from lawful custody
1300 00 open category	<b>Offences against public property or public interests</b>
1301 00	Public, social security or family benefit fraud
1302 00	Fraud affecting European benefits or allowances
1303 00	Offences related to illegal gambling
1304 00	Obstructing of public tender procedures
1305 00	Active or passive corruption of a civil servant, a person holding public office or public authority
1306 00	Embezzlement, misappropriation or other diversion of property by a public official
1307 00	Abuse of a function by a public official
1400 00 open category	<b>Tax and customs offences</b>
1401 00	Tax offences
1402 00	Customs offences
1500 00 open category	<b>Economic and trade related offences</b>
1501 00	Bankruptcy or fraudulent insolvency
1502 00	Breach of accounting regulation, embezzlement, concealment of assets or unlawful increase in a company's liabilities

1503 00	Violation of competition rules
1504 00	Laundering of proceeds from crime
1505 00	Active or passive corruption in the private sector
1506 00	Revealing a secret or breaching an obligation of secrecy
1507 00	'Insider trading'
1600 00 open category	<b>Offences against property or causing damage to goods</b>
1601 00	Unlawful appropriation
1602 00	Unlawful appropriation or diversion of energy
1603 00	Fraud, including swindling
1604 00	Dealing in stolen goods
1605 00	Illicit trafficking (6) in cultural goods, including antiques and works of art
1606 00	Intentional damage or destruction of property
1607 00	Unintentional damage or destruction of property
1608 00	Sabotage
1609 00	Offences against industrial or intellectual property
1610 00	Arson
1611 00	Arson causing death or injury to persons
1612 00	Forest arson
1700 00 open category	<b>Theft offences</b>

1701 00	Theft
1702 00	Theft after unlawful entry into property
1703 00	Theft, using violence or weapons, or using threat of violence or weapons against person
1704 00	Forms of aggravated theft which do not involve use of violence or weapons, or use of threat of violence or weapons, against persons.
1800 00 open category	<b>Offences against information systems and other computer-related crime</b>
1801 00	Illegal access to information systems
1802 00	Illegal system interference
1803 00	Illegal data interference
1804 00	Production, possession, dissemination of or trafficking in computer devices or data enabling commitment of computer-related offences
1900 00 open category	<b>Forgery of means of payment</b>
1901 00	Counterfeiting or forging currency
1902 00	Counterfeiting of non-cash means of payment
1903 00	Counterfeiting or forging public fiduciary documents
1904 00	Putting into circulation/using counterfeited or forged currency, non-cash means of payment or public fiduciary documents
1905 00	Possession of a device for the counterfeiting or forgery of currency or public fiduciary documents
2000 00 open category	<b>Falsification of documents</b>

2001 00	Falsification of a public or administrative document by a private individual
2002 00	Falsification of a document by a civil servant or a public authority
2003 00	Supply or acquisition of a forged public or administrative document; supply or acquisition of a forged document by a civil servant or a public authority
2004 00	Using forged public or administrative documents
2005 00	Possession of a device for the falsification of public or administrative documents
2006 00	Forgery of private documents by a private individual
2100 00 open category	<b>Offences against traffic regulations</b>
2101 00	Dangerous driving
2102 00	Driving under the influence of alcohol or narcotic drugs
2103 00	Driving without a licence or while disqualified
2104 00	Failure to stop after a road accident
2105 00	Avoiding a road check
2106 00	Offences related to road transport
2200 00 open category	<b>Offences against labour law</b>
2201 00	Unlawful employment
2202 00	Offences relating to remuneration, including social security contributions
2203 00	Offences relating to working conditions, health and safety at work
2204 00	Offences relating to access to or exercise of a professional activity



2205 00	Offences relating to working hours and rest time
2300 00 open category	<b>Offences against migration law</b>
2301 00	Unauthorised entry or residence
2302 00	Facilitation of unauthorised entry and residence
2400 00 open category	<b>Offences against military obligations</b>
2500 00 open category	<b>Offences related to hormonal substances and other growth promoters</b>
2501 00	Illicit importation, exportation or supply of hormonal substances and other growth promoters
2600 00 open category	<b>Offences related to nuclear materials or other hazardous radioactive substances</b>
2601 00	Illicit importation, exportation, supply or acquisition of nuclear or radioactive materials
2700 00 open category	<b>Other offences</b>
2701 00	Other intentional offences
2702 00	Other unintentional offences

(1) Unless otherwise specified in this category, ‘trafficking’ means import, export, acquisition, sale, delivery, movement or transfer.

(2) For the purposes of this sub-category trafficking includes acquisition, sale, delivery, movement or transfer.

(3) For the purposes of this sub-category trafficking includes import, export, acquisition, sale, delivery, movement or transfer.

- (4) For example: particularly grave circumstances.
- (5) For example rape with particular cruelty.
- (6) Trafficking includes import, export, acquisition, sale, delivery, movement or transfer.

<b>Parameters</b>		
Level of completion:	Completed act	C
	Attempt or preparation	A
	Non-transmitted element	∅
Level of participation:	Perpetrator	M
	Aider and abettor or instigator/organiser, conspirator	H
	Non-transmitted element	∅
Exemption from criminal responsibility:	Insanity or diminished responsibility	S
<b>Recidivism</b>		R

**Common table of penalties and measures categories, with a table of parameters, referred to in Article 5(3) and (4) of Chapter 1 [Format of transmission of information]**

<b>Code</b>	<b>Categories and sub-categories of penalties and measures</b>
1000 open category	<b>Deprivation of freedom</b>
1001	Imprisonment
1002	Life imprisonment
2000 open category	<b>Restriction of personal freedom</b>
2001	Prohibition from frequenting some places

2002	Restriction to travel abroad
2003	Prohibition to stay in some places
2004	Prohibition from entry to a mass event
2005	Prohibition to enter in contact with certain persons through whatever means
2006	Placement under electronic surveillance (1)
2007	Obligation to report at specified times to a specific authority
2008	Obligation to stay/reside in a certain place
2009	Obligation to be at the place of residence on the set time
2010	Obligation to comply with the probation measures ordered by the court, including the obligation to remain under supervision
3000 open category	<b>Prohibition of a specific right or capacity</b>
3001	Disqualification from function
3002	Loss/suspension of capacity to hold or to be appointed to public office
3003	Loss/suspension of the right to vote or to be elected
3004	Incapacity to contract with public administration
3005	Ineligibility to obtain public subsidies
3006	Cancellation of the driving licence (2)
3007	Suspension of driving licence
3008	Prohibition to drive certain vehicles
3009	Loss/suspension of the parental authority

3010	Loss/suspension of right to be an expert in court proceedings/witness under oath/juror
3011	Loss/suspension of right to be a legal guardian (3)
3012	Loss/suspension of right of decoration or title
3013	Prohibition to exercise professional, commercial or social activity
3014	Prohibition from working or activity with minors
3015	Obligation to close an establishment
3016	Prohibition to hold or to carry weapons
3017	Withdrawal of a hunting/fishing license
3018	Prohibition to issue cheques or to use payment/credit cards
3019	Prohibition to keep animals
3020	Prohibition to possess or use certain items other than weapons
3021	Prohibition to play certain games/sports
4000 open category	<b>Prohibition or expulsion from territory</b>
4001	Prohibition from national territory
4002	Expulsion from national territory
5000 open category	<b>Personal obligation</b>
5001	Submission to medical treatment or other forms of therapy
5002	Submission to a social-educational programme

5003	Obligation to be under the care/control of the family
5004	Educational measures
5005	Socio-judicial probation
5006	Obligation of training/working
5007	Obligation to provide judicial authorities with specific information
5008	Obligation to publish the judgment
5009	Obligation to compensate for the prejudice caused by the offence
6000 open category	<b>Penalty on personal property</b>
6001	Confiscation
6002	Demolition
6003	Restoration
7000 open category	<b>Placing in an institution</b>
7001	Placing in a psychiatric institution
7002	Placing in a detoxification institution
7003	Placing in an educational institution
8000 open category	<b>Financial penalty</b>
8001	Fine
8002	Day-fine (4)

8003	Fine for the benefit of a special recipient (5)
9000 open category	<b>Working penalty</b>
9001	Community service or work
9002	Community service or work accompanied with other restrictive measures
10000 open category	<b>Military penalty</b>
10001	Loss of military rank (6)
10002	Expulsion from professional military service
10003	Military imprisonment
11000 open category	<b>Exemption/deferment of sentence/penalty, warning</b>
12000 open category	<b>Other penalties and measures</b>

<b>Parameters (to be specified where applicable)</b>	
∅	Penalty
m	Measure
a	Suspended penalty/measure
b	Partially suspended penalty/measure
c	Suspended penalty/measure with probation/supervision

d	Partially suspended penalty/measure with probation/supervision
e	Conversion of penalty/measure
f	Alternative penalty/measure imposed as principal penalty
g	Alternative penalty/measure imposed initially in case of non-respect of the principal penalty
h	Revocation of suspended penalty/measure
i	Subsequent formation of an overall penalty
j	Interruption of enforcement/postponement of the penalty/measure (7)
k	Remission of the penalty
l	Remission of the suspended penalty
n	End of penalty
o	Pardon
p	Amnesty
q	Release on parole (liberation of a person before end of the sentence under certain conditions)
r	Rehabilitation (with or without the deletion of penalty from criminal records)
s	Penalty or measure specific to minors
t	Non-criminal ruling (8)

- 
- (1) Fixed or mobile placement.
  - (2) Reapplication in order to obtain a new driving licence is necessary.
  - (3) Legal guardian for a person who is legally incompetent or for a minor.
  - (4) Fine expressed in daily units.
  - (5) E.g.: for an institution, association, foundation or a victim.
  - (6) Military demotion.
  - (7) Does not lead to avoidance of enforcement of penalty.
  - (8) This parameter will be indicated only when such information is provided in reply to the request received by the State of nationality of the person concerned.

*This document has been agreed between the European Union and the United Kingdom and is provided for information only. No rights may be derived from it until the date of application. The numbering of the articles is provisional.*



## **ANNEX LAW-7: DEFINITION OF TERRORISM**

### **1. Scope**

For the purposes of Title IX [Exchange of criminal record information] of Part Three, point (b) of Article LAW.SURR.79(3) [Scope], Article LAW.SURR.79(4) [Scope], point (c) of Article LAW.SURR.82(2) [Political offence exception], point (a) of Article LAW.CONFISC.15(2) [Grounds for refusal], ANNEX LAW-5 [ARREST WARRANT] and ANNEX LAW-8 [Freezing and Confiscation], “terrorism” means the offences as defined in paragraphs 3 to 14 of this Annex.

### **2. Definitions of terrorist group and structured group**

2.1. “Terrorist group” means a structured group of more than two persons, established for a period of time and acting in concert to commit terrorist offences.

2.2. “Structured group” means a group that is not randomly formed for the immediate commission of an offence and that does not need to have formally defined roles for its members, continuity of its membership or a developed structure.

### **3. Terrorist offences**

3.1. Intentional acts, as defined as offences under domestic law, which, given their nature or context may seriously damage a country or an international organisation where committed with one of the aims listed in paragraph 3.2:

- (a) attacks upon a person’s life which may cause death;
- (b) attacks upon the physical integrity of a person;
- (c) kidnapping or hostage-taking;
- (d) causing extensive destruction to a government or public facility, a transport system, an infrastructure facility, including an information system, a fixed platform located on the continental shelf, a public place or private property likely to endanger human life or result in major economic loss;
- (e) seizure of aircraft, ships or other means of public or goods transport;
- (f) manufacture, possession, acquisition, transport, supply or use of explosives or weapons, including chemical, biological, radiological or nuclear weapons, as well as research into, and development of, chemical, biological, radiological or nuclear weapons;
- (g) release of dangerous substances, or causing fires, floods or explosions, the effect of which is to endanger human life;
- (h) interfering with or disrupting the supply of water, power or any other fundamental natural resource, the effect of which is to endanger human life;

- (i) seriously hindering or interrupting the functioning of an information system by inputting computer data, by transmitting, damaging, deleting, deteriorating, altering or suppressing such data, or by rendering such data inaccessible, intentionally and without right, in cases where:
  - i. a significant number of information systems have been affected through the use of a tool designed or adapted primarily for that purpose;
  - ii. the offence causes serious damage;
  - iii. the offence is committed against a critical infrastructure information system;
- (j) deleting, damaging, deteriorating, altering or suppressing computer data on an information system, or rendering such data inaccessible, intentionally and without right, in cases where the offence is committed against a critical infrastructure information system;
- (k) threatening to commit any of the acts listed in points (a) to (j).

3.2. The aims referred to in paragraph 3.1 are:

- (a) seriously intimidating a population;
- (b) unduly compelling a government or an international organisation to perform or abstain from performing any act;
- (c) seriously destabilising or destroying the fundamental political, constitutional, economic or social structures of a country or an international organisation.

4. Offences relating to a terrorist group

The following intentional acts:

- (a) directing a terrorist group;
- (b) participating in the activities of a terrorist group, including by supplying information or material resources, or by funding its activities in any way, with knowledge of the fact that such participation will contribute to the criminal activities of the terrorist group.

5. Public provocation to commit a terrorist offence

The distribution, or otherwise making available by any means, whether online or offline, of a message to the public, with the intent to incite the commission of one of the offences listed in points (a) to (j) of paragraph 3.1 where such conduct, directly or indirectly, such as by the glorification of terrorist acts, advocates the commission of terrorist offences, thereby causing a danger that one or more such offences may be committed when committed intentionally.

6. Recruitment for terrorism

Soliciting another person to commit or contribute to the commission of one of the offences listed in points (a) to (j) of paragraph 3.1, or in paragraph 4 when committed intentionally.

7. Providing training for terrorism

Providing instruction on the making or use of explosives, firearms or other weapons or noxious or hazardous substances, or on other specific methods or techniques, for the purpose of committing, or contributing to the commission of, one of the offences listed in points (a) to (j) of paragraph 3.1, knowing that the skills provided are intended to be used for this purpose when committed intentionally.

8. Receiving training for terrorism

Receiving instruction on the making or use of explosives, firearms or other weapons or noxious or hazardous substances, or on other specific methods or techniques, for the purpose of committing, or contributing to the commission of, one of the offences listed in points (a) to (j) of paragraph 3.1 when committed intentionally.

9. Travelling for the purpose of terrorism

9.1. Travelling to a country other than that State for the purpose of committing, or contributing to the commission of, a terrorist offence as referred to in paragraph 3, for the purpose of the participation in the activities of a terrorist group with knowledge of the fact that such participation will contribute to the criminal activities of such a group as referred to in paragraph 4, or for the purpose of providing or receiving training for terrorism as referred to in paragraphs 7 and 8 when committed intentionally.

9.2. In addition, the following conduct when committed intentionally:

- (a) travelling to that State for the purpose of committing, or contributing to the commission of, a terrorist offence as referred to in paragraph 3, for the purpose of the participation in the activities of a terrorist group with knowledge of the fact that such participation will contribute to the criminal activities of such a group as referred to in paragraph 4, or for the purpose of providing or receiving training for terrorism as referred to in paragraphs 7 and 8; or
- (b) preparatory acts undertaken by a person entering that State with the intention to commit, or contribute to the commission of, a terrorist offence as referred to in paragraph 3.1.

10. Organising or otherwise facilitating travelling for the purpose of terrorism

Any act of organisation or facilitation that assists any person in travelling for the purpose of terrorism, as referred to in paragraph 9.1 and point (a) of paragraph 9.2, knowing that the assistance thus rendered is for that purpose when committed intentionally.

## 11. Terrorist financing

11.1. Providing or collecting funds, by any means, directly or indirectly, with the intention that they be used, or in the knowledge that they are to be used, in full or in part, to commit, or to contribute to the commission of, any of the offences referred to in paragraphs 3 to 10 when committed intentionally.

11.2. Where the terrorist financing referred to in paragraph 11.1 concerns any of the offences laid down in paragraphs 3, 4 and 9, it shall not be necessary that the funds be in fact used, in full or in part, to commit, or to contribute to the commission of, any of those offences, nor shall it be required that the offender knows for which specific offence or offences the funds are to be used.

## 12. Other offences related to terrorist activities

The following intentional acts:

- (a) aggravated theft with a view to committing one of the offences listed in paragraph 3;
- (b) extortion with a view to committing one of the offences listed in paragraph 3;
- (c) drawing up or using false administrative documents with a view to committing one of the offences listed points (a) to (j) of paragraph 3.1, point (b) of paragraph 4, and paragraph 9.

## 13. Relationship to terrorist offences

For an offence referred to in paragraphs 4 to 12 to be considered terrorism as referred to in paragraph 1, it shall not be necessary that a terrorist act be actually committed, nor shall it be necessary, insofar as the offences referred to in paragraphs 5 to 10 and 12 are concerned, to establish a link to another specific offence laid down in this Annex.

## 14. Aiding and abetting, inciting and attempting

The following acts:

- (a) aiding and abetting an offence referred to in paragraphs 3 to 8, 11 and 12;
- (b) inciting an offence referred to in paragraphs 3 to 12; and
- (c) attempting to commit an offence referred to in paragraphs 3, 6, 7, paragraph 9.1, point (a) of paragraph 9.2, and paragraphs 11 and 12, with the exception of possession as provided for in point (f) of paragraph 3.1 and the offence referred to in point (k) of paragraph 3.1.

## ANNEX LAW-8: FREEZING AND CONFISCATION

### Freezing / Provisional Measures Request Form

#### SECTION A

Requesting State: .....

Requested State: .....

#### SECTION B: Urgency

Grounds for urgency and/or requested date of execution:

Time limits for execution of the freezing request are set out in Article LAW.CONFISC.8 [Obligation to take provisional measures] of the Agreement. However, if a shorter or specific time limit is necessary, please provide the date and explain the reason for this:

#### SECTION C: Relevant persons

State all information, as far as known, regarding the identity of the (1) natural or (2) legal person(s) concerned in the freezing request or of the person(s) that owns/own the property that is covered by the freezing request (if more than one person is concerned, please provide the information for each person):

1. Natural person:

Name:

First name(s):

Other relevant name(s), if applicable:

Aliases, if applicable:

Sex:

Nationality:

Identity number or social security number:

Type and number of the identity document(s) (ID card, passport), if available:

Date of birth:

Place of birth:

Residence and/or known address; if address not known, state the last known address:

Language(s) which the person understands:

Please indicate whether this person has the freezing request directed against him or her or owns the property that is

covered by the freezing request:

2. Legal person:

Name:

Form of legal person:

Shortened name, commonly used name or trading name, if applicable:

Registered seat:

Registration number:

Address of the legal person:

Name of the legal person's representative:

Please indicate whether this legal person has the freezing request directed against it or owns the property that is covered by the freezing request:

If different from the address above, please give the location where the freezing measure is to be carried out:

3. Third parties:

(i) Third parties whose rights in relation to the property that is covered by the freezing request are directly prejudiced by the request (identity and grounds), if applicable:

(ii) In case third parties have had the opportunity to claim rights, attach documents demonstrating that this has been the case.

4. Provide any other information that will assist with the execution of the freezing request:

**SECTION D: Relevant Property**

State all information, as far as known, regarding the assets subject of the freezing request. Please provide details of all property and individual items where applicable:

1. If relating to an amount of money:

(i) Grounds for believing that the person has property/income in the requested State

(ii) Description and location of the property/source of income of that person

(iii) Exact location of the property/source of income of that person

(iv) Details of the bank account of that person (if known)

2. If the freezing request concerns specific item(s) of property (or property of equivalent value to such property):

(i) Grounds for believing that the specific item(s) of property is located in the requested State

(ii) Description and location of the specific item(s) of property

(iii) Other relevant information

3. Total amount requested for freezing or execution in the requested State (in figures and words, indicate currency):

**SECTION E: Grounds for request or issuing freezing order (if applicable)**

Summary of the facts:

1. Set out the reasons for the freezing request or why the order has been issued, including a summary of the underlying facts and grounds for freezing, a description of the criminal offence(s) charged, under investigation or subject to proceedings, the stage the investigation or proceedings have reached, the reasons for any risk factors and any other relevant information.

2. Nature and legal classification of the criminal offence(s) in relation to which the freezing request relates or the order was issued and the applicable legal provision(s).

3. The following applies only in the case(s) where both the requesting and requested State have made a notification under Article LAW.CONFISC.15 [Grounds for refusal] (2) of the Agreement: if applicable, tick one or more of the following offences, as defined by the law of the requesting State, punishable in the requesting State by a custodial sentence or detention order for a maximum period of at least three years. Where the freezing request or order concerns several criminal offences, please indicate numbers in the list of criminal offences below (corresponding to the criminal offences as described under points 1 and 2 above):

- participation in a criminal organisation
- terrorism as defined in Annex LAW-7 [Definition of terrorism]
- trafficking in human beings
- sexual exploitation of children and child pornography
- illicit trafficking in narcotic drugs and psychotropic substances
- illicit trafficking in weapons, munitions and explosives
- corruption, including bribery
- fraud, including that affecting the financial interests of the United Kingdom, a Member State or the Union
- laundering of the proceeds of crime
- counterfeiting currency
- computer-related crime
- environmental crime, including illicit trafficking in endangered animal species and endangered plant species and varieties
- facilitation of unauthorised entry and residence
- murder
- grievous bodily injury
- illicit trade in human organs and tissue
- kidnapping, illegal restraint and hostage-taking
- racism and xenophobia
- organised or armed robbery
- illicit trafficking in cultural goods, including antiques and works of art
- swindling
- racketeering and extortion
- counterfeiting and piracy of products
- forgery of administrative documents and trafficking therein
- forgery of means of payment
- illicit trafficking in hormonal substances and other growth promoters
- illicit trafficking in nuclear or radioactive materials
- trafficking in stolen vehicles
- rape
- arson
- crimes within the jurisdiction of the International Criminal Court
- unlawful seizure of aircraft, ships or spacecraft
- sabotage

4. Any other relevant information (e.g. relation between the property and the criminal offence):

**SECTION F: Confidentiality**

- Need to maintain the information in the request confidential after execution:
  
- Need for specific formalities at the time of execution:



**SECTION G: Requests to more than one State**

Where a freezing request has been transmitted to more than one State, provide the following information:

1. A freezing request has been transmitted to the following other State(s) (State and authority):
  
2. Please indicate the reasons for transmitting freezing requests to multiple States:
  
3. Value of assets, if known, in each requested State:
  
4. Please indicate any specific needs:

**SECTION H: Relation to earlier freezing requests or orders**

If applicable, provide information relevant to identify previous or related freezing requests:

1. Date of request or issue and transmission of order:
  
2. Authority to which it was transmitted:
  
3. Reference given by the issuing and executing authorities:

**SECTION I: Confiscation**

This freezing request is accompanied by a confiscation order issued in the requesting State (reference number of the confiscation order):

- Yes, reference number:  
 No

The property shall remain frozen in the requested State pending the transmission and execution of the confiscation order (estimated date for submission of the confiscation order, if possible):

**SECTION J: Legal remedies (if applicable)**

Please indicate if a legal remedy can be sought in the requesting State against the issuing of a freezing request/order, and if so please provide further details (description of the legal remedy, including necessary steps to take and deadlines):

**SECTION K: Issuing Authority**

If there is a freezing order in the requesting state upon which this freezing request is based, please provide the following details:

1. Type of issuing authority:

- judge, court, public prosecutor
- another competent authority designated by the requesting State

2. Contact details:

Official name of the issuing authority:

Name of its representative:

Post held (title/grade):

File no:

Address:

Tel. No: (country code) (area/city code)

Fax No: (country code) (area/city code)

E-mail:

Languages in which it is possible to communicate with the issuing authority:

Signature of the issuing authority and/or its representative certifying the content of the Freezing/Provisional Measures Request Form as accurate and correct:

Name:

Post held (title/grade):

Date:

Official stamp (if available):

**SECTION L: Validating Authority**

Please indicate the type of authority which has validated the Freezing/Provisional Measures Request Form, if applicable:

- judge, court, public prosecutor
- another competent authority designated by the requesting State

Official name of the validating authority:

Name of its representative:

Post held (title/grade):

File no:

Address:

Tel. No: (country code) (area/city code)

Fax No: (country code) (area/city code)

E-mail:

Languages in which it is possible to communicate with the competent authority:

**SECTION M: Central Authority**

Please indicate the central authority responsible for the administrative transmission and receipt of freezing requests in the requesting State:

Official name of the central authority:

Name of its representative:

Post held (title/grade):

File no:

Address:

Tel. No: (country code) (area/city code)

Fax No: (country code) (area/city code)

E-mail:

Languages in which it is possible to communicate with the competent authority:

**SECTION N: Further information**

1. Please indicate if the main contact point in the requesting State should be the:

- issuing authority
- competent authority
- central authority

2. If different from above, please provide the contact details of the person(s) to contact for additional information regarding this freezing request:

Name/Title/Organisation:

Address:

E-mail/Contact Phone No:

**SECTION O: Annexes**

The original or duly authenticated copy of the freezing order must be provided with the Freezing/Provisional Measures Request Form if a freezing order has been issued in the requesting State.

**Confiscation Request Form**

**SECTION A**

Requesting State: .....

Requested State: .....

**SECTION B: Confiscation order**

Date of issue: .....

Date order became final: .....

Reference number: .....

Total amount of order in figures and words, indicate currency

Amount requested for execution in requested State, or if specific type(s) of property, description and location of property

Please provide details of the court findings in relation to the confiscation order:

- property is the proceeds of an offence, or equivalent to the full or part of the value of such proceeds
- property constitutes instrumentalities of such an offence
- property is liable to extended confiscation
- property is subject to confiscation under any other provisions relating to powers of confiscation, including confiscation without a final conviction, under the law of the requesting State following proceedings in relation to a criminal offence

**SECTION C: Affected persons**

State all information, as far as known, regarding the identity of the (1) natural or (2) legal person(s) affected by the confiscation request (if more than one person is concerned, please provide the information for each person):

1. Natural person:

Name:

First name(s):

Other relevant name(s), if applicable:

Aliases, if applicable:

Sex:

Nationality:

Identity number or social security number:

Type and number of the identity document(s) (ID card, passport), if available:

Date of birth:

Place of birth:

Residence and/or known address; if address not known, state the last known address:

Language(s) which the person understands:

Please indicate whether this person has the confiscation request directed against him or her or owns the property that is covered by the confiscation request:

2. Legal person:

Name:

Form of legal person:

Shortened name, commonly used name or trading name, if applicable:

Registered seat:

Registration number:

Address of the legal person:

Name of the legal person's representative:

If different from the address above, please give the location where the confiscation request is to be carried out:

3. Third parties:

(i) Third parties whose rights in relation to the property that is covered by the confiscation request are directly prejudiced by the request (identity and grounds), if known/applicable:

(ii) In case third parties have had the opportunity to claim rights, attach documents demonstrating that this has been the case.

4. Provide any other information that will assist with the execution of the confiscation request:

#### **SECTION D: Affected Property**

State all information, as far as known, regarding the assets subject to the confiscation. Please provide details of all property and individual items where applicable:

1. If relating to amount of money:

(i) Grounds for believing that the person has property/income in the requested State:

(ii) Description and location of the property/source of income:

2. If the request concerns specific item(s) of property:

(i) Grounds for believing that the specific item(s) of property is/are located in the requested State:

(ii) Description and location of the specific item(s) of property:

3. Value of property:

(i) Total amount of request (approximate amount):

(ii) Total amount requested for execution in the requested State (approximate amount):

(iii) If specific type(s) of property, description and location of property:

**SECTION E: Grounds for confiscation**

Summary of the facts:

1. Set out the reasons why a confiscation order has been issued, including a summary of the underlying facts and grounds for confiscation, a description of offences, the reasons for any risk factors and any other relevant information (such as date, place and circumstances of the offence):

2. Nature and legal classification of the offence(s) in relation to which the confiscation order was issued and the applicable legal provision(s):

3. The following applies only in the case where both the requesting and requested State have made a notification under Article LAW.CONFISC.15 [Grounds for refusal] (2) of the Agreement: if applicable, tick one or more of the following offences, as defined by the law of the requesting State, punishable in the requesting State by a custodial sentence or detention order for a maximum period of at least three years. Where the confiscation order concerns several criminal offences, please indicate numbers in the list of criminal offences below (corresponding to the criminal offences as

described under points 1 and 2 above):

- participation in a criminal organisation
- terrorism as defined in Annex LAW-7 [Definition of terrorism]
- trafficking in human beings
- sexual exploitation of children and child pornography
- illicit trafficking in narcotic drugs and psychotropic substances
- illicit trafficking in weapons, munitions and explosives
- corruption, including bribery
- fraud, including that affecting the financial interests of the United Kingdom, a Member State or the Union
- laundering of the proceeds of crime
- counterfeiting currency
- computer-related crime
- environmental crime, including illicit trafficking in endangered animal species and endangered plant species and varieties
- facilitation of unauthorised entry and residence
- murder
- grievous bodily injury
- illicit trade in human organs and tissue
- kidnapping, illegal restraint and hostage-taking
- racism and xenophobia
- organised or armed robbery
- illicit trafficking in cultural goods, including antiques and works of art
- swindling
- racketeering and extortion
- counterfeiting and piracy of products
- forgery of administrative documents and trafficking therein
- forgery of means of payment
- illicit trafficking in hormonal substances and other growth promoters
- illicit trafficking in nuclear or radioactive materials
- trafficking in stolen vehicles
- rape
- arson
- crimes within the jurisdiction of the International Criminal Court
- unlawful seizure of aircraft, ships, or spacecraft
- sabotage

4. Any other relevant information (e.g. relation between the property and the criminal offence):

#### **SECTION F: Confidentiality**

- Need to maintain the information in the request or part of it confidential

Please indicate any relevant information:

#### **SECTION G: Requests to more than one State**

Where a confiscation request has been transmitted to more than one State, provide the following information:

1. A confiscation request has been transmitted to the following other State(s) (State and authority):



2. Reasons for transmitting confiscation request to multiple States (select appropriate reasons):

(i) If a request concerns specific items of property:

- Different items of property covered by the request are believed to be located in different States
- The confiscation request relates to a specific item of property and requires action in more than one State

(ii) If the confiscation request concerns an amount of money:

- The estimated value of the property which may be confiscated in the requesting State and in any one requested State is not likely to be sufficient to cover the full amount set out in the order
- Other specific needs:

3. Value of assets, if known, in each requested State:

4. If confiscation of the specific item(s) of property requires action in more than one State, description of the action to be taken in the requested State:

**SECTION H: Conversion and transfer of property**

1. If the confiscation request concerns a specific item of property, confirm whether the requesting State allows for the confiscation in the requested State to take the form of a requirement to pay a sum of money corresponding to the value of the property:

- Yes
- No

2. If the confiscation concerns an amount of money, state whether property, other than money obtained from the execution of the confiscation request, may be transferred to the requesting State:

- Yes
- No

**SECTION I: Imprisonment in default or other measures restricting the liberty of a person**

<p>Please indicate whether the requesting State allows for the application by the requested State of imprisonment in default or other measures restricting the liberty of a person where it is not possible to execute the confiscation request, either wholly or partially:</p> <p><input type="checkbox"/> Yes <input type="checkbox"/> No</p>
<p><b>SECTION J: Restitution or victim compensation</b></p> <p>1. Please indicate, where relevant:</p> <p><input type="checkbox"/> An issuing authority or another competent authority of the requesting State has issued a decision to compensate the victim with, or restitute to the victim, the following sum of money:</p> <p><input type="checkbox"/> An issuing authority or another competent authority of the requesting State has issued a decision to restitute the following property other than money to the victim:</p> <p>2. Details of the decision to restitute property to, or compensate, the victim:</p> <p>Issuing authority (official name): Date of the decision: Reference number of the decision (if available): Description of the property to be restituted or amount awarded in compensation: Name of the victim: Address of the victim:</p>
<p><b>SECTION K: Legal remedies</b></p> <p>Please indicate if a legal remedy has already been sought against the issuing of a confiscation order, and if so please provide further details (description of the legal remedy, including necessary steps to take and deadlines):</p>
<p><b>SECTION L: Issuing Authority</b></p> <p>Please provide details on the authority which issued the confiscation request in the requesting State:</p>

1. Type of the issuing authority:

- judge, court, public prosecutor
- another competent authority designated by the requesting State

2. Contact details:

Official name of the issuing authority:

Name of its representative:

Post held (title/grade):

File no:

Address:

Tel. No: (country code) (area/city code)

Fax No: (country code) (area/city code)

E-mail:

Languages in which it is possible to communicate with the issuing authority:

Signature of the issuing authority and/or its representative certifying the content of the Confiscation Request Form as accurate and correct:

Name:

Post held (title/grade):

Date:

Official stamp (if available):

**SECTION M: Validating Authority**

Please indicate the type of authority which has validated the Confiscation Request Form, if applicable:

- judge, court, public prosecutor
  
- another competent authority designated by the issuing State

Official name of the validating authority:

Name of its representative:

Post held (title/grade):

File no:

Address:

Tel. No: (country code) (area/city code)

Fax No: (country code) (area/city code)

E-mail:

Languages in which it is possible to communicate with the competent authority:

**SECTION N: Central Authority**

Please indicate the central authority responsible for the administrative transmission and receipt of the Confiscation Request Form in the requesting State:

Official name of the central authority:

Name of its representative:

Post held (title/grade):

File no:

Address:

Tel. No: (country code) (area/city code)

Fax No: (country code) (area/city code)

E-mail:

Languages in which it is possible to communicate with the competent authority:

**SECTION O: Further information**

1. Please indicate if the main contact point in the requesting State should be the:

- issuing authority
- competent authority
- central authority

2. If different from above, please provide the contact details of the person(s) to contact for additional information regarding this Confiscation Request Form:

Name/ Title/ Organisation:

Address:

E-mail/Contact Phone No:

**SECTION P: Annexes**

The original or duly authenticated copy of the confiscation order must be provided with the Confiscation Request Form.

#### **ANNEX UNPRO-1: IMPLEMENTATION OF THE FINANCIAL CONDITIONS**

1. The Commission shall communicate to the United Kingdom, as soon as possible and at the latest on 16 April of the financial year, the following information for each Union programme, activity, or part thereof, in which the United Kingdom participates:
  - (a) the amounts in commitment appropriations in the Union budget definitively adopted for the year in question for the budget lines covering participation of the United Kingdom in accordance with Protocol I [Programmes and activities in which the United Kingdom participates] of this Agreement and, if relevant, the amount of external assigned appropriations that do not result from financial contribution from other donors on these budget lines;
  - (b) the amount of the participation fee referred to in Article UNPRO.2.1 (4)[Financial conditions] of this Agreement;
  - (c) from year N+1 of implementation of a programme included in the Protocol referred to in Article UNPRO.1.3 [Establishment of the participation] of this Agreement, the implementation of commitment appropriations corresponding to budgetary year N and the level of decommitment;
  - (d) for programmes to which Article UNPRO.2.2 [Programmes to which an automatic correction mechanism applies] applies, for the part of the programmes where such information is necessary to calculate the automatic correction, the level of commitments entered into in favour of United Kingdom entities broken down according to the corresponding year of budgetary appropriations and the related total level of commitments.

On the basis of its Draft Budget, the Commission shall provide an estimate of information under points (a) and (b) as soon as possible, and, at the latest, by 1 September of the financial year.

2. The Commission shall issue, at the latest on 16 April and on 16 July of each financial year, a call for funds to the United Kingdom that corresponds to the contribution of the United Kingdom under this Agreement for each of the programmes, activities, or parts thereof, in which the United Kingdom participates.
3. The United Kingdom shall pay the amount indicated in the call for funds at the latest 60 days after the call for funds is issued. The United Kingdom may make separate payments for each programme and activity.
4. By derogation from paragraphs 2 and 3, for the year 2021 in which the Protocol referred to in Article UNPRO.1.3 [Establishment of the participation] of this Agreement is concluded, the Commission shall issue a call for funds at the latest on 16 April 2021 if the Protocol is signed on or before 31 March 2021, or at the latest on the 16th of the month following the month in which the Protocol was signed if it is signed after 31 March 2021. If that call for funds is issued after 16 July of the year in question, there shall be a single call for funds for this year. The United Kingdom shall pay the amount indicated in the call for funds at the latest 60 days after the call for funds is issued. The United Kingdom may make separate payments for each programme and activity.
5. The call for funds for a given year shall have the value established by dividing the annual amount calculated in application of Article UNPRO.2.1 [Financial conditions] of this Agreement, including any adjustment under Article UNPRO.2.1 (8) [Financial conditions] of this Agreement,

under Article UNPRO.2.2 [Programmes to which an automatic correction mechanism applies] of this Agreement or UNPRO.2.3 [Financing in relation to programmes implemented through financial instruments or budgetary guarantees] of this Agreement, by the number of calls for funds for that year pursuant to paragraphs 2 and 4 of this Annex.

6. By derogation from paragraph 5, in relation to the contribution to Horizon Europe for the multiannual financial framework 2021-2027, the call for funds for a given year N shall have the value established by dividing:

(a) the annual amount calculated

i. by applying the following payment schedule for payments if year N is:

-2021: 50% paid in 2021, 50% paid in 2026

-2022: 50% paid in 2022, 50% paid in 2027

ii. on the amount resulting from the application of Articles UNPRO.2.1 [Financial conditions] and UNPRO.2.2 [Programmes to which an automatic correction mechanism applies] of this Agreement, including any adjustment under Article UNPRO.2.1 (8) [Financial conditions] or Article UNPRO.2.2 [Programmes to which an automatic correction mechanism applies] of this Agreement for that year N, by

(b) the number of calls for funds for that year N pursuant to paragraphs 2 and 4:

The application of this paragraph has no bearing on establishing the calculation of the automatic correction under Articles UNPRO.2.2 [Programmes to which an automatic correction mechanism applies] and UNPRO.3.4 [Performance review].

For all the calculations of other amounts related to Part V of this Agreement, the annual contribution of the United Kingdom shall take into account this paragraph.

7. Where the participation of the United Kingdom is terminated pursuant to Article UNPRO.3.2 [Termination of the participation of the United Kingdom in a Union programme by the Union] or Article UNPRO.3.3. [Termination of the participation in a programme in the case of substantial modification of Union programme] of this Agreement any payments in relation to the period before the termination takes effect, which were postponed in accordance with paragraph 6 of this Annex, shall become due. The Commission shall issue a call for funds in relation to the amount due at the latest one month after the termination takes effect. The United Kingdom shall pay this due amount within 60 days of the issue of the call for funds.

8. The Regulation (EU, Euratom) 2018/1046 of the European Parliament and of the Council<sup>159</sup> ('Financial Regulation') applicable to the general budget of the European Union shall apply to the management of the appropriations.

---

<sup>159</sup> Regulation (EU, Euratom) 2018/1046 of the European Parliament and of the Council of 18 July 2018 on the financial rules applicable to the general budget of the Union, amending Regulations (EU) No 1296/2013, (EU) No 1301/2013, (EU) No 1303/2013, (EU) No 1304/2013, (EU) No 1309/2013, (EU) No 1316/2013, (EU) No 223/2014, (EU) No 283/2014, and Decision No 541/2014/EU and repealing Regulation (EU, Euratom) No 966/2012 (OJ EU L 193, 30.7.2018, p. 1).

9. In the absence of payment by the United Kingdom by the due date, the Commission shall send a formal letter of reminder.

Any delay in the payment of the contribution shall give rise to the payment of default interest by the United Kingdom on the outstanding amount as from the due date until the day on which that outstanding amount is paid in full.

The interest rate for amounts receivable but not paid on the due date shall be the rate applied by the European Central Bank to its principal refinancing operations, as published in the C series of the Official Journal of the European Union, in force on the first day of the month in which the due date falls, or 0 per cent, whichever is higher, plus three and a half percentage points.



## **ANNEX INST: RULES OF PROCEDURE FOR DISPUTE SETTLEMENT**

### **I. Definitions**

1. For the purposes of Title I [Dispute Settlement] of Part Six of this Agreement and of these Rules of Procedure, the following definitions apply:

- (a) "administrative staff", in respect of an arbitrator, means individuals under the direction and control of an arbitrator, other than assistants;
- (b) "adviser" means an individual retained by a Party to advise or assist that Party in connection with the arbitration proceedings;
- (c) "arbitration tribunal" means a tribunal established under Article INST.15 [Establishment of an arbitration tribunal] of Title I [Dispute Settlement] of Part Six of this Agreement;
- (d) "arbitrator" means a member of the arbitration tribunal;
- (e) "assistant" means an individual who, under the terms of appointment and under the direction and control of an arbitrator, conducts research or provides assistance to that arbitrator;
- (f) "complaining Party" means any Party that requests the establishment of an arbitration tribunal under Article INST.14 [Arbitration Procedure] of Title I [Dispute Settlement] of Part Six of this Agreement;
- (g) "registry" means an external body with relevant expertise appointed by the Parties to provide administrative support for the proceedings;
- (h) "respondent Party" means the Party that is alleged to be in violation of the covered provisions; and
- (i) "representative of a Party" means an employee or any individual appointed by a government department, agency or any other public entity of a Party who represents the Party for the purposes of a dispute under this Agreement or any supplementing agreement.

### **II. Notifications**

2. Any request, notice, written submission or other document of:

- (a) the arbitration tribunal shall be sent to both Parties at the same time;
- (b) a Party, which is addressed to the arbitration tribunal, shall be copied to the other Party at the same time; and
- (c) a Party, which is addressed to the other Party, shall be copied to the arbitration tribunal at the same time, as appropriate.

3. Any notification referred to in rule 2 shall be made by e-mail or, where appropriate, any other means of telecommunication that provides a record of the sending thereof. Unless proven otherwise, such notification shall be deemed to be delivered on the date of its sending.

4. All notifications shall be addressed to the Legal Service of the European Commission and to the Legal Adviser of the Foreign, Commonwealth & Development Office of the United Kingdom, respectively.

5. Minor errors of a clerical nature in a request, notice, written submission or other document related to the arbitration tribunal proceedings may be corrected by delivery of a new document clearly indicating the changes.

6. If the last day for delivery of a document falls on a non-working day of the institutions of the Union or of the government of the United Kingdom, the time period for the delivery of the document shall end on the first following working day.

### **III. Appointment of arbitrators**

7. If pursuant to Article INST.15 (Establishment of an arbitration tribunal) of Title I [Dispute Settlement] of Part Six of this Agreement, an arbitrator is selected by lot, the co-chair of the Partnership Council of the complaining Party shall promptly inform the co-chair of the respondent Party of the date, time and venue of the lot. The respondent Party may, if it so chooses, be present during the lot. In any event, the lot shall be carried out with the Party or Parties that are present.

8. The co-chair of the complaining Party shall notify, in writing, each individual who has been selected to serve as an arbitrator of his or her appointment. Each individual shall confirm his or her availability to both Parties within five days from the date on which he or she was informed of his or her appointment.

9. The co-chair of the Partnership Council of the complaining Party shall select by lot the arbitrator or chairperson, within five days from the expiry of the time period referred to in Article INST.15(2) [Establishment of an arbitration tribunal] of Title I [Dispute Settlement] of Part Six of this Agreement, if any of the sub-lists referred in paragraph 1 of Article INST.27 [List of arbitrators] of Title I [Dispute Settlement] of Part Six of this Agreement:

- (a) is not established, amongst those individuals who have been formally proposed by one or both Parties for the establishment of that particular sub-list; or
- (b) no longer contains at least five individuals, amongst those individuals who remain on that particular sub-list.

9a. The Parties may appoint a registry to assist in the organisation and conduct of specific dispute settlement proceedings on the basis of ad-hoc arrangements or on the basis of arrangements adopted by the Partnership Council pursuant to Article INST.34A [Annexes] of Title I [Dispute Settlement] of Part Six of this Agreement. To that end, the Partnership Council shall consider no later than 180 days after the entry into force of this Agreement whether there are any necessary amendments to these Rules of Procedure.

### **IV. Organisational Meeting**

10. Unless the Parties agree otherwise, they shall meet the arbitration tribunal within seven days of its establishment in order to determine such matters that the Parties or the arbitration tribunal deem to be appropriate, including:

- (a) if not determined earlier, the remuneration and expenses to be paid to the arbitrators, which shall in any case be in accordance with WTO standards;

- (b) the remuneration to be paid to assistants; the total amount of the remuneration of an assistant or assistants of each arbitrator shall not exceed 50% of the remuneration of that arbitrator;
- (c) the timetable of the proceedings; and
- (d) ad-hoc procedures to protect confidential information.

Arbitrators and representatives of the Parties may take part in this meeting via telephone or video conference.

## **V. Written Submissions**

11. The complaining Party shall deliver its written submission no later than 20 days after the date of establishment of the arbitration tribunal. The respondent Party shall deliver its written submission no later than 20 days after the date of delivery of the written submission of the complaining Party.

## **VI. Operation of the arbitration tribunal**

12. The chairperson of the arbitration tribunal shall preside at all its meetings. The arbitration tribunal may delegate to the chairperson the authority to make administrative and procedural decisions.

13. Unless otherwise provided in Title I [Dispute Settlement] of Part Six of this Agreement or in these Rules of Procedure, the arbitration tribunal may conduct its activities by any means, including telephone, facsimile transmissions or computer links.

14. Only arbitrators may take part in the deliberations of the arbitration tribunal, but the arbitration tribunal may permit their assistants to be present at its deliberations.

15. The drafting of any decision and report shall remain the exclusive responsibility of the arbitration tribunal and shall not be delegated.

16. Where a procedural question arises that is not covered by Title I [Dispute Settlement] of Part Six of this Agreement and its Annexes, the arbitration tribunal, after consulting the Parties, may adopt an appropriate procedure that is compatible with those provisions.

17. When the arbitration tribunal considers that there is a need to modify any of the time periods for the proceedings other than the time periods set out in Title I [Dispute Settlement] of Part Six of this Agreement or to make any other procedural or administrative adjustment, it shall inform the Parties, in writing and after consultation of the Parties, of the reasons for the change or adjustment and of the time period or adjustment needed.

## **VII. Replacement**

18. When a Party considers that an arbitrator does not comply with the requirements of Annex INST-X (Code of Conduct for arbitrators) and for that reason should be replaced, that Party shall notify the other Party within 15 days from when it obtained sufficient evidence of the arbitrator's alleged failure to comply with the requirements of that Annex.

19. The Parties shall consult within 15 days of the notification referred to in rule 18. They shall inform the arbitrator of his or her alleged failure and they may request the arbitrator to take steps to ameliorate the failure. They may also, if they so agree, remove the arbitrator and select a new

arbitrator in accordance with Article INST.15 (Establishment of an arbitration tribunal) of Title I [Dispute Settlement] of Part Six of this Agreement.

20. If the Parties fail to agree on the need to replace the arbitrator, other than the chairperson of the arbitration tribunal, either Party may request that this matter be referred to the chairperson of the arbitration tribunal, whose decision shall be final.

If the chairperson of the arbitration tribunal finds that the arbitrator does not comply with the requirements of Annex INST-X (Code of Conduct for arbitrators), the new arbitrator shall be selected in accordance with INST.15 (Establishment of an arbitration tribunal) of Title I [Dispute Settlement] of Part Six of this Agreement.

21. If the Parties fail to agree on the need to replace the chairperson, either Party may request that this matter be referred to one of the remaining members of the pool of individuals from the sub-list of chairpersons established under INST.27 (Lists of arbitrators) of Title I [Dispute Settlement] of Part Six of this Agreement. His or her name shall be drawn by lot by the co-chair of the Partnership Council from the requesting Party, or the chair's delegate. The decision by the selected person on the need to replace the chairperson shall be final.

If this person finds that the chairperson does not comply with the requirements of Annex INST-X (Code of Conduct for arbitrators), the new chairperson shall be selected in accordance with Article INST.15 (Establishment of an arbitration tribunal) of Title I [Dispute Settlement] of Part Six of this Agreement.

### **VIII. Hearings**

22. On the basis of the timetable determined pursuant to rule 10, after consulting with the Parties and the other arbitrators, the chairperson of the arbitration tribunal shall notify the Parties of the date, time and venue of the hearing. That information shall be made publicly available by the Party in which the hearing takes place, unless the hearing is closed to the public.

23. Unless the Parties agree otherwise, the hearing shall be held in London if the complaining Party is the Union and in Brussels if the complaining Party is the United Kingdom. The respondent Party shall bear the expenses derived from the logistical administration of the hearing.

24. The arbitration tribunal may convene additional hearings if the Parties so agree.

25. All arbitrators shall be present during the entirety of the hearing.

26. Unless the Parties agree otherwise, the following persons may attend the hearing, irrespective of whether the hearing is open to the public or not:

- (a) representatives of a Party;
- (b) advisers;
- (c) assistants and administrative staff;
- (d) interpreters, translators and court reporters of the arbitration tribunal; and
- (e) experts, as decided by the arbitration tribunal pursuant to Article INST.26(2) [Receipt of Information] of Title I [Dispute Settlement] of Part Six of this Agreement.

27. No later than five days before the date of a hearing, each Party shall deliver to the arbitration tribunal and to the other Party a list of the names of persons who will make oral

arguments or presentations at the hearing on behalf of that Party and of other representatives and advisers who will be attending the hearing.

28. The arbitration tribunal shall conduct the hearing in the following manner, ensuring that the complaining Party and the respondent Party are afforded equal time in both argument and rebuttal argument:

*Argument*

- (a) argument of the complaining Party;
- (b) argument of the respondent Party.

*Rebuttal Argument*

- (a) reply of the complaining Party;
- (b) counter-reply of the respondent Party.

29. The arbitration tribunal may direct questions to either Party at any time during the hearing.

30. The arbitration tribunal shall arrange for a transcript of the hearing to be prepared and delivered to the Parties as soon as possible after the hearing. The Parties may comment on the transcript and the arbitration tribunal may consider those comments.

31. Each Party may deliver a supplementary written submission concerning any matter that arises during the hearing within 10 days after the date of the hearing.

## **IX. Questions in Writing**

32. The arbitration tribunal may at any time during the proceedings submit questions in writing to one or both Parties. Any questions submitted to one Party shall be copied to the other Party.

33. Each Party shall provide the other Party with a copy of its responses to the questions submitted by the arbitration tribunal. The other Party shall have an opportunity to provide comments in writing on the Party's responses within five days after the delivery of such copy.

## **X. Confidentiality**

34. Each Party and the arbitration tribunal shall treat as confidential any information submitted by the other Party to the arbitration tribunal that the other Party has designated as confidential. When a Party submits to the arbitration tribunal a written submission which contains confidential information, it shall also provide, within 15 days, a submission without the confidential information which shall be disclosed to the public.

35. Nothing in these Rules of Procedure shall preclude a Party from disclosing statements of its own positions to the public to the extent that, when making reference to information submitted by the other Party, it does not disclose any information designated by the other Party as confidential.

36. The arbitration tribunal shall hold the relevant parts of the session in private when the submission and arguments of a Party contain confidential information. The Parties shall maintain the confidentiality of the arbitration tribunal hearings when the hearings are held in closed session.

## **XI. Ex parte contacts**

37. The arbitration tribunal shall not meet or communicate with a Party in the absence of the other Party.

38. An arbitrator shall not discuss any aspect of the subject matter of the proceedings with a Party or both Parties in the absence of the other arbitrators.

## **XII. Amicus curiae submissions**

39. Unless the Parties agree otherwise within five days of the date of the establishment of the arbitration tribunal, the arbitration tribunal may receive unsolicited written submissions from natural persons of a Party or legal persons established in the territory of a Party that are independent from the governments of the Parties, provided that they:

- (a) are received by the arbitration tribunal within 10 days of the date of the establishment of the arbitration tribunal;
- (b) are concise and in no case longer than 15 pages, including any annexes, typed at double space;
- (c) are directly relevant to a factual or a legal issue under consideration by the arbitration tribunal;
- (d) contain a description of the person making the submission, including for a natural person his or her nationality and for a legal person its place of establishment, the nature of its activities, its legal status, general objectives and its source of financing;
- (e) specify the nature of the interest that the person has in the arbitration proceedings; and
- (f) are drafted in English.

40. The submissions shall be delivered to the Parties for their comments. The Parties may submit comments, within 10 days of the delivery, to the arbitration tribunal.

41. The arbitration tribunal shall list in its report all the submissions it has received pursuant to rule 39. The arbitration tribunal shall not be obliged to address in its report the arguments made in such submissions, however, if it does, it shall also take into account any comments made by the Parties pursuant to rule 40.

## **XIII. Urgent cases**

42. In cases of urgency referred to in Article INST.19 [Urgent proceedings] of Title I [Dispute Settlement] of Part Six of this Agreement, the arbitration tribunal, after consulting the Parties, shall adjust, as appropriate, the time periods referred to in these Rules of Procedure. The arbitration tribunal shall notify the Parties of such adjustments.

## **XIV. Translation and interpretation**

43. The language of proceedings before the arbitration tribunal shall be English. Reports and decisions of the arbitration tribunal shall be issued in English.

44. Each party shall bear its own costs of the translation of any documents submitted to the arbitration tribunal which are not originally drafted in English, as well as any costs relating to interpretation during the hearing related to its representatives or advisers.

## **XV. Other Procedures**

48. The time periods laid down in these Rules of Procedure shall be adjusted in accordance with the special time periods provided for the adoption of a report or decision by the arbitration tribunal in the proceedings provided for in Article INST.22 (Reasonable Period of Time), Article INST.23 (Compliance Review), Article INST.24 (Temporary Remedies) and Article INST.25 (Review of any Measure taken to comply after the Adoption of Temporary Remedies) of Title I [Dispute Settlement] of Part Six of this Agreement.

## **ANNEX INST: CODE OF CONDUCT FOR ARBITRATORS**

### **I. Definitions**

1. For the purposes of this this Code of Conduct, the following definitions apply:
  - (a) "administrative staff" means, in respect of an arbitrator, individuals under the direction and control of an arbitrator, other than assistants;
  - (b) "arbitrator" means a member of an arbitration tribunal;
  - (c) "assistant" means an individual who, under the terms of appointment of an arbitrator, conducts research or provides assistance to that arbitrator; and
  - (d) "candidate" means an individual whose name is on a list of arbitrators referred to in Article INST.27 [Lists of Arbitrators] of Title I [Dispute Settlement] of Part Six of this Agreement or who is under consideration for selection as an arbitrator under Article INST.15 [Establishment of an arbitration tribunal] of Title I [Dispute Settlement] of Part Six of this Agreement.

### **II. Governing Principles**

2. In order to preserve the integrity and impartiality of the dispute settlement mechanism, each candidate and arbitrator shall:
  - (a) get acquainted with this Code of Conduct;
  - (b) be independent and impartial;
  - (c) avoid direct or indirect conflicts of interest;
  - (d) avoid impropriety and the appearance of impropriety or bias;
  - (e) observe high standards of conduct; and
  - (f) not be influenced by self-interest, outside pressure, political considerations, public clamour, and loyalty to a Party or fear of criticism.
3. An arbitrator shall not, directly or indirectly, incur any obligation or accept any benefit that would in any way interfere, or appear to interfere, with the proper performance of his or her duties.
4. An arbitrator shall not use his or her position on the arbitration tribunal to advance any personal or private interests. An arbitrator shall avoid actions that may create the impression that others are in a special position to influence him or her.
5. An arbitrator shall not allow past or existing financial, business, professional, personal, or social relationships or responsibilities to influence his or her conduct or judgement.
6. An arbitrator shall avoid entering into any relationship or acquiring any financial interest that is likely to affect his or her impartiality or that might reasonably create an appearance of impropriety or bias.



### **III. Disclosure obligations**

7. Prior to the acceptance of his or her appointment as an arbitrator under Article INST.15 [Establishment of an arbitration tribunal] of Title I [Dispute Settlement] of Part Six of this Agreement, a candidate requested to serve as an arbitrator shall disclose any interest, relationship or matter that is likely to affect his or her independence or impartiality or that might reasonably create an appearance of impropriety or bias in the proceedings. To that end, a candidate shall make all reasonable efforts to become aware of any such interests, relationships and matters, including financial interests, professional interests, or employment or family interests.

8. The disclosure obligation under paragraph 7 is a continuing duty which requires an arbitrator to disclose any such interests, relationships or matters that may arise during any stage of the proceedings.

9. A candidate or an arbitrator shall communicate to the Partnership Council for consideration by the Parties any matters concerning actual or potential violations of this Code of Conduct at the earliest time he or she becomes aware of them.

### **IV. Duties of Arbitrators**

10. Upon acceptance of his or her appointment, an arbitrator shall be available to perform and shall perform his or her duties thoroughly and expeditiously throughout the proceedings, and with fairness and diligence.

11. An arbitrator shall consider only the issues raised in the proceedings and which are necessary for a decision and shall not delegate that duty to any other person.

12. An arbitrator shall take all appropriate steps to ensure that his or her assistants and administrative staff are aware of, and comply with, the obligations incurred by arbitrators under Parts II, III, IV and VI of this Code of Conduct.

### **V. Obligations of Former Arbitrators**

13. Each former arbitrator shall avoid actions that may create the appearance that he or she was biased in carrying out the duties or derived advantage from the decision of the arbitration tribunal.

14. Each former arbitrator shall comply with the obligations in Part VI of this Code of Conduct.

### **VI. Confidentiality**

15. An arbitrator shall not, at any time, disclose any non-public information concerning the proceedings or acquired during the proceedings for which he or she has been appointed. An arbitrator shall not, in any case, disclose or use such information to gain personal advantage or advantage for others, or to adversely affect the interests of others.

16. An arbitrator shall not disclose a decision of the arbitration tribunal or parts thereof prior to its publication in accordance with Title I [Dispute Settlement] of Part Six of this Agreement.

17. An arbitrator shall not, at any time, disclose the deliberations of an arbitration tribunal, or any arbitrator's view, nor make any statements on the proceedings for which he or she has been appointed or on the issues in dispute in the proceedings.

## **VII. Expenses**

18. Each arbitrator shall keep a record and render a final account of the time devoted to the proceedings and of his or her expenses, as well as the time and expenses of his or her assistants and administrative staff.

## **PROTOCOL ON ADMINISTRATIVE COOPERATION AND COMBATING FRAUD IN THE FIELD OF VALUE ADDED TAX AND ON MUTUAL ASSISTANCE FOR THE RECOVERY OF CLAIMS RELATING TO TAXES AND DUTIES**

### *TITLE I: GENERAL PROVISIONS*

#### Article 1: Objective

The objective of this Protocol is to establish the framework for administrative cooperation between the Member States and the United Kingdom, in order to enable their authorities to assist each other in ensuring compliance with VAT legislation and in protecting VAT revenue and in recovering claims relating to taxes and duties.

#### Article 2: Scope

1. This Protocol lays down rules and procedures for cooperation:
  - (a) to exchange any information that may help to effect a correct assessment of VAT, monitor the correct application of VAT, and combat VAT fraud; and
  - (b) for the recovery of:
    - (i) claims relating to VAT, customs duties and excise duties, levied by or on behalf of a State or its territorial or administrative subdivisions, excluding the local authorities, or on behalf of the Union;
    - (ii) administrative penalties, fines, fees and surcharges relating to the claims referred to in point (i) imposed by the administrative authorities that are competent to levy the taxes or duties concerned or carry out administrative enquiries with regard to them, or confirmed by administrative or judicial bodies at the request of those administrative authorities; and
    - (iii) interest and costs relating to the claims referred to in points (i) and (ii).
2. This Protocol does not affect the application of the rules on administrative cooperation and combating fraud in the field of VAT and assistance for the recovery of claims between Member States.
3. This Protocol does not affect the application of the rules on mutual assistance in criminal matters.

#### Article 3: Definitions

For the purpose of this Protocol, the following definitions shall apply:

- (a) "administrative enquiry" means all the controls, checks and other action taken by the States in the performance of their duties with a view to ensuring the proper application of the VAT legislation;
- (b) "applicant authority" means a central liaison office or a liaison department of a State which makes a request under Title III [Recovery assistance];

- (c) "automatic exchange" means the systematic communication of predefined information to another State, without prior request;
- (d) "by electronic means" means using electronic equipment for the processing (including digital compression) and storage of data, and employing wires, radio transmission, optical technologies or other electromagnetic means;
- (e) "CCN/CSI network" means the common platform based on the common communication network ('CCN') and common system interface ('CSI'), developed by the Union to ensure all transmissions by electronic means between competent authorities in the area of taxation.
- (f) "central liaison office" means the office designated pursuant to paragraph 2 of Article 4 [Organisation] with the principal responsibility for contacts for the application of Title II [Administrative Cooperation and Combating VAT Fraud] or Title III [Recovery assistance];
- (g) "competent authority" means the authority designated pursuant to paragraph 1 of Article 4 [Organisation];
- (h) "competent official" means any official designated pursuant to paragraph 4 of Article 4 [Organisation] who can directly exchange information under Title II [Administrative Cooperation and Combating VAT Fraud];
- (i) "customs duties" means the duty payable on goods entering or leaving the customs territory of each Party in accordance with the rules set out in the customs legislation of the respective Parties;
- (j) "excise duties" means those duties and charges defined as such under the domestic legislation of the State in which the applicant authority is located;
- (k) "liaison department" means any office other than the central liaison office designated as such pursuant to paragraph 3 of Article 4 [Organisation] to request or grant mutual assistance under Title II [Administrative Cooperation and Combating VAT Fraud] or Title III [Recovery assistance];
- (l) "person" means any person as defined in point (m) of Article OTH.1(l), of Title XVII [OTHER PROVISIONS] of Part Two of this Agreement.<sup>160</sup>
- (m) "requested authority" means the central liaison office, the liaison department or – as far as cooperation under Title II [Administrative Cooperation and Combating VAT Fraud] is concerned – the competent official who receives a request from a requesting or an applicant authority;

---

<sup>160</sup> For greater certainty and in particular for the purposes of this Protocol, it is understood that the term "person" includes any association of persons lacking the legal status of a legal person but recognised under applicable law as having the capacity to perform legal acts. It also includes any other legal arrangement of whatever nature and form, having legal personality or not, which conducts transactions which are subject to VAT or which is liable for the payment of the claims referred to in point (b) of paragraph 1 of Article 2 [Scope] of this Protocol.

- (n) "requesting authority" means a central liaison office, a liaison department or a competent official who makes a request for assistance under Title II [Administrative Cooperation and Combating VAT Fraud], on behalf of a competent authority;
- (o) "simultaneous control" means the coordinated checking of the tax situation of a taxable person or of two or more related taxable persons organised by two or more States with common or complementary interests;
- (p) "Specialised Committee" means the Trade Specialised Committee on Administrative cooperation in VAT and Recovery of Taxes and Duties;
- (q) "spontaneous exchange" means the non-systematic communication, at any moment and without prior request, of information to another State;
- (r) "State" means a Member State, or the United Kingdom, as the context requires;
- (s) "third country" means a country that is neither a Member State nor the United Kingdom;
- (t) "VAT" means value added tax pursuant to Council Directive 2006/112/EC on the common system of value added tax for the Union and means value added tax pursuant to the Value Added Tax Act 1994 for the United Kingdom.

#### Article 4: Organisation

- 1 Each State shall designate a competent authority responsible for the application of this Protocol.
- 2 Each State shall designate:
  - (a) one central liaison office with the principal responsibility for the application of Title II [Administrative Cooperation and Combating VAT Fraud] of this Protocol; and
  - (b) one central liaison office with the principal responsibility for the application of Title III [Recovery assistance] of this Protocol.
- 3 Each competent authority may designate, directly or by delegation:
  - (a) liaison departments to exchange directly information under Title II [Administrative Cooperation and Combating VAT Fraud] of this Protocol;
  - (b) liaison departments to request or grant mutual assistance under Title III [Recovery assistance] of this Protocol, in relation to their specific territorial or operational competences.
- 4 Each competent authority may designate, directly or by delegation, competent officials who can directly exchange information on the basis of Title II [Administrative Cooperation and Combating VAT Fraud] of this Protocol.
- 5 Each central liaison office shall keep the list of liaison departments and competent officials up-to-date and make it available to the other central liaison offices.
- 6 Where a liaison department or a competent official sends or receives a request for assistance under this Protocol, it shall inform its central liaison office thereof.

7. Where a central liaison office, a liaison department or a competent official receives a request for mutual assistance requiring action outside its competence, it shall forward the request without delay to the competent central liaison office or liaison department, and shall inform the requesting or applicant authority thereof. In such a case, the period laid down in Article 8 [Time limit for providing information] shall start the day after the request for assistance has been forwarded to the competent central liaison office or the competent liaison department.

8. Each Party shall inform the Specialised Committee of its competent authorities for the purposes of this Protocol within one month of the signature of this Agreement and of any changes regarding those competent authorities without delay. The Specialised Committee shall keep the list of competent authorities updated.

#### Article 5: Service level agreement

A service level agreement ensuring the technical quality and quantity of the services for the functioning of the communication and information exchange systems shall be concluded according to a procedure established by the Specialised Committee.

#### Article 6: Confidentiality

1. Any information obtained by a State under this Protocol shall be treated as confidential and shall be protected in the same manner as information obtained under its domestic law.

2. Such information may be disclosed to persons or authorities (including courts and administrative or supervisory bodies) concerned with the application of VAT laws and for the purpose of a correct assessment of VAT as well as for the purpose of applying enforcement measures including recovery or precautionary measures with regard to claims referred to in point (b) of paragraph 1 of Article 2 [Scope].

3. The information referred to in paragraph 1 may also be used for assessment of other taxes and for assessment and enforcement, including recovery or precautionary measures, with regard to claims relating to compulsory social security contributions. If the information exchanged reveals or helps to prove the existence of breaches of the tax law, it may also be used for imposing administrative or criminal sanctions. Only the persons or authorities mentioned in paragraph 2 may use the information and then only for purposes set out in the preceding sentences of this paragraph. They may disclose it in public court proceedings or in judicial decisions.

4. Notwithstanding paragraphs 1 and 2, the State providing the information shall, on the basis of a reasoned request, permit its use for purposes other than those referred to in paragraph 1 of Article 2 [Scope] by the State which receives the information if, under the legislation of the State providing the information, the information may be used for similar purposes. The requested authority shall accept or refuse any such request within one month.

5. Reports, statements and any other documents, or certified true copies or extracts thereof, obtained by a State under the assistance provided by this Protocol may be invoked as evidence in that State on the same basis as similar documents provided by another authority of that State.

6. Information provided by a State to another State may be transmitted by the latter to another State, subject to prior authorisation by the competent authority from which the information originated. The State of origin of the information may oppose such a sharing of information within

ten working days of the date on which it received the communication from the State wishing to share the information.

7. The States may transmit information obtained in accordance with this Protocol to third countries subject to the following conditions:

- (a) the competent authority from which the information originates has consented to that transmission; and
- (b) the transmission is permitted by assistance arrangements between the State transmitting the information and that particular third country.

8. When a State receives information from a third country, the States may exchange that information, in so far as permitted by the assistance arrangements with that particular third country.

9. Each State shall immediately notify the other States concerned regarding any breach of confidentiality, and any sanctions and remedial actions consequently imposed.

10. Persons duly accredited by the Security Accreditation Authority of the European Commission may have access to this information only in so far as it is necessary for care, maintenance and development of the electronic systems hosted by the European Commission and used by the States to implement this Protocol.

## *TITLE II: ADMINISTRATIVE COOPERATION AND COMBATING VAT FRAUD*

### Chapter one: Exchange of information on request

#### Article 7: Exchange of information and administrative enquiries

1. At the request of the requesting authority, the requested authority shall communicate the information referred to point (a) of paragraph 1 of Article 2 [Scope], including any information relating to a specific case or cases.

2. For the purpose of forwarding the information referred to in paragraph 1, the requested authority shall arrange for the conduct of any administrative enquiries necessary to obtain such information.

3. The request referred to in paragraph 1 may contain a reasoned request for a specific administrative enquiry. The requested authority shall undertake the administrative enquiry in consultation with the requesting authority where necessary. If the requested authority takes the view that no administrative enquiry is necessary, it shall immediately inform the requesting authority of the reasons thereof.

4. Where the requested authority refuses to undertake an administrative enquiry into amounts that were declared or amounts that should have been declared by a taxable person established in the State of the requested authority in connection with supplies of goods or services and imports of goods which are made by that taxable person and which are taxable in the State of the requesting authority, the requested authority shall at least provide to the requesting authority the dates and values of any relevant supplies and imports made by the taxable person in the State of the requesting authority over the previous two years, unless the requested authority does not hold and is not required to hold this information under domestic legislation.

5. In order to obtain the information sought or to conduct the administrative enquiry requested, the requested authority or the administrative authority to which it has recourse shall proceed as though acting on its own account or at the request of another authority in its own State.

6. At the request of the requesting authority, the requested authority shall communicate to it any pertinent information it obtains or has in its possession as well as the results of administrative enquiries, in the form of reports, statements and any other documents, or certified true copies or extracts thereof.

7. Original documents shall be provided only where this is not contrary to the provisions in force in the State of the requested authority.

#### Article 8: Time limit for providing information

1. The requested authority shall provide the information referred to in Article 7 as quickly as possible and no later than 90 days following the date of receipt of the request. However, where the requested authority is already in possession of that information, the time limit shall be reduced to a maximum period of 30 days.

2. In certain special categories of cases, time limits which are different from those provided for in paragraph 1 may be agreed between the requested and the requesting authorities.

3. Where the requested authority is unable to respond to the request within the time limits referred to in paragraphs 1 and 2, it shall forthwith inform the requesting authority in writing of the reasons for its failure to do so, and when it considers it would be likely to be able to respond.

#### Chapter two: Exchange of information without prior request

##### Article 9: Types of exchange of information

The exchange of information without prior request shall either be spontaneous exchanges, as provided for in Article 10, or automatic exchanges, as provided for in Article 11.

##### Article 10: Spontaneous exchange of information

The competent authority of a State shall, without prior request, forward to the competent authority of another State the information referred to in point (a) of paragraph 1 of Article 2 [Scope] which has not been forwarded under the automatic exchange referred to in Article 11 [Automatic exchange of information] and of which it is aware of in the following cases:

- (a) where taxation is deemed to take place in another State and information is necessary for the effectiveness of the control system of that State;
- (b) where a State has grounds to believe that a breach of VAT legislation has been committed or is likely to have been committed in the other State;
- (c) where there is a risk of tax loss in the other State.



### Article 11: Automatic exchange of information

1. The categories of information subject to automatic exchange shall be determined by the Specialised Committee in accordance with Article 39 [Trade Specialised Committee on Administrative Cooperation in VAT and Recovery of Taxes and Duties].
2. A State may abstain from taking part in the automatic exchange of one or more categories of information referred to in paragraph 1 where the collection of information for such exchange would require the imposition of new obligations on persons liable for VAT or would impose a disproportionate administrative burden on that State.
3. Each State shall notify the Specialised Committee in writing of its decision taken in accordance with the previous paragraph.

### Chapter three: Other forms of cooperation

#### Article 12: Administrative notification

1. The requested authority shall, at the request of the requesting authority and in accordance with the rules governing the notification of similar instruments and decisions in the State of the requested authority, notify the addressee of all instruments and decisions which have been sent from the requesting authorities and concern the application of VAT legislation in the State of the requesting authority.
2. Requests for notification, mentioning the subject of the instrument or decision to be notified, shall indicate the name, address and any other relevant information for identifying the addressee.
3. The requested authority shall inform the requesting authority immediately of its response to the request for notification and notify it, in particular, of the date of notification of the decision or instrument to the addressee.

#### Article 13: Presence in administrative offices and participation in administrative enquiries

1. By agreement between the requesting authority and the requested authority, and in accordance with the arrangements laid down by the latter, the requested authority may allow officials authorised by the requesting authority to be present in the offices of the requested authority, or any other place where those authorities carry out their duties, with a view to exchanging the information referred to in point (a) of paragraph 1 of Article 2 [Scope]. Where the requested information is contained in documentation to which the officials of the requested authority have access, the officials of the requesting authority shall be given copies thereof on request.
2. By agreement between the requesting authority and the requested authority, and in accordance with the arrangements laid down by the latter, the requested authority may allow officials authorised by the requesting authority to be present during the administrative enquiries carried out in the territory of the State of the requested authority, with a view to exchanging the information referred to in point (a) of paragraph 1 of Article 2 [Scope]. Such administrative enquiries shall be carried out exclusively by the officials of the requested authority. The officials of the requesting authority shall not exercise the powers of inspection conferred on officials of the requested authority. They may, however, have access to the same premises and documents as the

latter, through the intermediation of the officials of the requested authority and for the sole purpose of carrying out the administrative enquiry.

3. By agreement between the requesting authorities and the requested authority, and in accordance with the arrangements laid down by the latter, officials authorised by the requesting authorities may take part in the administrative enquiries carried out in the territory of the requested State with a view to collecting and exchanging the information referred to in point (a) of paragraph 1 of Article 2 [Scope]. Such administrative enquiries shall be carried out jointly by the officials of the requesting and requested authorities and shall be conducted under the direction and according to the legislation of the requested State. The officials of the requesting authorities shall have access to the same premises and documents as the officials of the requested authority and, in so far as it is permitted under the legislation of the requested State for its officials, shall be able to interview taxable persons.

Where it is permitted under the legislation of the requested State, the officials of the requesting States shall exercise the same inspection powers as those conferred on officials of the requested State.

The inspection powers of the officials of the requesting authorities shall be exercised for the sole purpose of carrying out the administrative enquiry.

By agreement between the requesting authorities and the requested authority and in accordance with the arrangements laid down by the requested authority, the participating authorities may draft a common enquiry report.

4. The officials of the requesting authority present in another State in accordance with paragraphs 1, 2 and 3 must at all times be able to produce written authority stating their identity and their official capacity.

#### Article 14: Simultaneous controls

1. The States may agree to conduct simultaneous controls whenever they consider such controls to be more effective than controls carried out by only one State.

2. A State shall identify independently the taxable persons which it intends to propose for a simultaneous control. The competent authority of that State shall notify the competent authority of the other State concerned of the cases proposed for a simultaneous control. It shall give reasons for its choice, as far as possible, by providing the information which led to its decision. It shall specify the period of time during which such controls should be conducted.

3. A competent authority that receives the proposal for a simultaneous control shall confirm its agreement or communicate its reasoned refusal to the counterpart authority, in principle within two weeks of receipt of the proposal, but within a month of receipt of the proposal at the latest.

4. Each competent authority concerned shall appoint a representative to be responsible for supervising and coordinating the control operation.

#### Chapter four: General provisions

#### Article 15: Conditions governing the exchange of information

1. The requested authority shall provide a requesting authority with the information referred to in point (a) of paragraph 1 of Article 2 [Scope] or carry out an administrative notification referred to in Article 12 [Administrative notification] provided that:
  - (a) the number and nature of the requests for information or administrative notification made by the requesting authority do not impose a disproportionate administrative burden on that requested authority; and
  - (b) the requesting authority has exhausted the usual sources of information which it could have used in the circumstances to obtain the information requested or measures which it could reasonably have taken to carry out the administrative notification requested, without running the risk of jeopardising the achievement of the desired end.
2. This Protocol shall impose no obligation to have enquiries carried out or to provide information on a particular case if the laws or administrative practices of the State which would have to supply the information do not authorise that State to carry out those enquiries or collect or use that information for its own purposes.
3. A requested authority may refuse to provide information where the requesting authority is unable, for legal reasons, to provide similar information. The requested authority shall inform the Specialised Committee of the grounds for the refusal.
4. The provision of information may be refused where it would lead to the disclosure of a commercial, industrial or professional secret or of a commercial process, or of information whose disclosure would be contrary to public policy.
5. Paragraphs 2, 3 and 4 should in no case be interpreted as authorising the requested authority to refuse to supply information on the sole grounds that this information is held by a bank, other financial institution, nominee or person acting in an agency or fiduciary capacity or because it relates to ownership interests in a legal person.
6. The requested authority shall inform the requesting authority of the grounds for refusing a request for assistance.

#### Article 16: Feedback

Where a competent authority provides information pursuant to Article 7 [Exchange of information and administrative enquiries] or 10 [Spontaneous exchange of information], it may request the competent authority which receives the information to give feedback thereon. If such request is made, the competent authority which receives the information shall, without prejudice to the rules on tax secrecy and data protection applicable in its State, send feedback as soon as possible, provided that this does not impose a disproportionate administrative burden on it.

#### Article 17: Language

Requests for assistance, including requests for notification and attached documents, shall be made in a language agreed between the requested and requesting authority.

#### Article 18: Statistical data

1. By 30 June each year, the Parties shall communicate by electronic means to the Specialised Committee statistical data on the application of this Title.
2. The content and format of the statistical data to be communicated under paragraph 1 shall be determined by the Specialised Committee.

#### Article 19: Standard forms and means of communication

1. Any information communicated pursuant to Articles 7 [Exchange of information and administrative enquiries], 10 [Spontaneous exchange of information], 11 [Automatic exchange of information], 12 [Administrative notification] and 16 [Feedback] and the statistics pursuant to Article 18 [Statistical data] shall be provided using a standard form referred to in point (d) of paragraph 2 of Article 39 [Trade Specialised Committee on Administrative Cooperation in VAT and Recovery of Taxes and Duties], except in the cases referred to in paragraphs 7 and 8 of Article 6 [Confidentiality] or in specific cases where the respective competent authorities deem other secure means more appropriate and agree to use those means.
2. The standard forms shall be transmitted, in so far as possible, by electronic means.
3. Where the request has not been lodged completely through the electronic systems, the requested authority shall confirm receipt of the request by electronic means without delay and, in any event, no later than five working days after receipt.
4. Where an authority has received a request or information of which it is not the intended recipient, it shall send a message by electronic means to the sender without delay and, in any event, no later than five working days after receipt.
5. Pending the adoption by the Specialised Committee of the decisions referred to in paragraph 2 of Article 39 [Trade Specialised Committee on Administrative Cooperation in VAT and Recovery of Taxes and Duties], the competent authorities shall make use of the rules set out in the Annex to this Protocol, including the standard forms.

### *TITLE III: RECOVERY ASSISTANCE*

#### Chapter one: Exchange of information

#### Article 20: Request for information

1. At the request of the applicant authority, the requested authority shall provide any information which is foreseeably relevant to the applicant authority in the recovery of its claims as referred to in point (b) of paragraph 1 of Article 2 [Scope]. The request for information shall include, where available, the name and any other data relevant to the identification of the persons concerned.

For the purpose of providing that information, the requested authority shall arrange for the carrying-out of any administrative enquiries necessary to obtain it.

2. The requested authority shall not be obliged to supply information:

- (a) which it would not be able to obtain for the purpose of recovering similar claims on its own behalf;
- (b) which would disclose any commercial, industrial or professional secrets; or
- (c) the disclosure of which would be liable to prejudice the security of or be contrary to the public policy of the State of the requested authority.

3. Paragraph 2 shall in no case be construed as permitting a requested authority to decline to supply information solely because this information is held by a bank, other financial institution, nominee or person acting in an agency or a fiduciary capacity or because it relates to ownership interests in a legal person.

4. The requested authority shall inform the applicant authority of the grounds for refusing a request for information.

#### Article 21: Exchange of information without prior request

Where a refund of taxes or duties relates to a person established or resident in another State, the State from which the refund is to be made may inform the State of establishment or residence of the pending refund.

#### Article 22: Presence in administrative offices and participation in administrative enquiries

1. By agreement between the applicant authority and the requested authority, and in accordance with the arrangements laid down by the latter, officials authorised by the applicant authority may, with a view to promoting mutual assistance provided for in this Title:

- (a) be present in the offices where officials of the requested State carry out their duties;
- (b) be present during administrative enquiries carried out in the territory of the requested State; and
- (c) assist the competent officials of the requested State during court proceedings in that State.

2. In so far as it is permitted under applicable legislation in the requested State, the agreement referred to in point (b) of paragraph 1 may provide that officials of the applicant authority may interview individuals and examine records.

3. Officials authorised by the applicant authority who make use of the possibility offered by paragraphs 1 and 2 must at all times be able to produce written authority stating their identity and their official capacity.

#### Chapter two: Assistance for the notification of documents

#### Article 23: Request for notification of certain documents relating to claims

1. At the request of the applicant authority, the requested authority shall notify to the addressee all documents, including those of a judicial nature, which have been sent from the State of the applicant authority and which relate to a claim as referred to in point (b) of paragraph 1 of Article 2 [Scope] or to its recovery.

The request for notification shall be accompanied by a standard form containing at least the following information:

- (a) name, address and other data relevant to the identification of the addressee;
- (b) the purpose of the notification and the period within which notification should be effected;
- (c) a description of the attached document and the nature and amount of the claim concerned;  
and
- (d) name, address and other contact details regarding:
  - (i) the office responsible with regard to the attached document; and
  - (ii) if different, the office where further information can be obtained concerning the notified document or concerning the possibilities for contesting the payment obligation.

2. The applicant authority shall make a request for notification pursuant to this Article only when it is unable to notify in accordance with the rules governing the notification of the document concerned in its own State or when such notification would give rise to disproportionate difficulties.

3. The requested authority shall forthwith inform the applicant authority of any action taken on its request for notification and in particular of the date of notification of the document to the addressee.

#### Article 24: Means of notification

1. The requested authority shall ensure that notification in the requested State is effected in accordance with the applicable national laws, regulations and administrative practices.

2. Paragraph 1 shall be without prejudice to any other form of notification made by a competent authority of the applicant State in accordance with the rules in force in that State.

A competent authority established in the applicant State may notify any document directly by registered mail or electronically to a person within the territory of another State.

#### Chapter three: Recovery or precautionary measures

##### Article 25: Request for recovery

1. At the request of the applicant authority, the requested authority shall recover claims which are the subject of an instrument permitting enforcement in the State of the applicant authority.

2. As soon as any relevant information relating to the matter which gave rise to the request for recovery comes to the knowledge of the applicant authority, it shall forward it to the requested authority.

##### Article 26: Conditions governing a request for recovery

1. The applicant authority may not make a request for recovery if and as long as the claim or the instrument permitting its enforcement are contested in the State of the applicant authority,

except in cases where the third subparagraph of paragraph 4 of Article 29 [Disputed claims and enforcement measures] applies.

2. Before the applicant authority makes a request for recovery, appropriate recovery procedures available in the State of the applicant authority shall be applied, except in the following situations:

- (a) where it is obvious that there are no assets for recovery in that State or that such procedures will not result in the payment of a substantial amount, and the applicant authority has specific information indicating that the person concerned has assets in the State of the requested authority;
- (b) where recourse to such procedures in the State of the applicant authority would give rise to disproportionate difficulty.

#### Article 27: Instrument permitting enforcement in the State of the requested authority and other accompanying documents

1. Any request for recovery shall be accompanied by a uniform instrument permitting enforcement in the State of the requested authority.

This uniform instrument permitting enforcement shall reflect the substantial contents of the initial instrument permitting enforcement in the State of the applicant authority, and constitute the sole basis for recovery and precautionary measures in the State of the requested authority. No act of recognition, supplementing or replacement shall be required in that State.

The uniform instrument permitting enforcement shall contain at least the following information:

- (a) information relevant to the identification of the initial instrument permitting enforcement, a description of the claim, including its nature, the period covered by the claim, any dates of relevance to the enforcement process, and the amount of the claim and its different components such as principal, interest accrued, etc.;
- (b) name and other data relevant to the identification of the debtor; and
- (c) name, address and other contact details regarding:
  - (i) the office responsible for the assessment of the claim; and
  - (ii) if different, the office where further information can be obtained concerning the claim or the possibilities for contesting the payment obligation.

2. The request for recovery of a claim may be accompanied by other documents relating to the claim issued by the State of the applicant authority.

#### Article 28: Execution of the request for recovery

1. For the purpose of the recovery in the State of the requested authority, any claim in respect of which a request for recovery has been made shall be treated as if it was a claim of that State, except where otherwise provided for in this Protocol. The requested authority shall make use of the



powers and procedures provided under the laws, regulations or administrative provisions of that State applying to its claims except where otherwise provided for in this Protocol.

The State of the requested authority shall not be obliged to grant to claims whose recovery is requested preferences accorded to similar claims arising in the State of the requested authority, except where otherwise agreed or provided under the law of that State.

The State of the requested authority shall recover the claim in its own currency.

2. The requested authority shall inform the applicant authority with due diligence of any action it has taken on the request for recovery.

3. From the date on which the recovery request is received, the requested authority shall charge interest for late payment in accordance with the laws, regulations and administrative provisions applicable to its own claims.

4. The requested authority may, where the applicable laws, regulations or administrative provisions so permit, allow the debtor time to pay or authorise payment by instalment and it may charge interest in that respect. It shall inform the applicant authority of any such decision.

5. Without prejudice to paragraph 1 of Article 35 [Costs], the requested authority shall remit to the applicant authority the amounts recovered with respect to the claim and the interest referred to in paragraphs 3 and 4 of this Article.

#### Article 29: Disputed claims and enforcement measures

1. Disputes concerning the claim, the initial instrument permitting enforcement in the State of the applicant authority or the uniform instrument permitting enforcement in the State of the requested authority and disputes concerning the validity of a notification made by an applicant authority shall fall within the competence of the competent bodies of the State of the applicant authority. If, in the course of the recovery procedure, the claim, the initial instrument permitting enforcement in the State of the applicant authority or the uniform instrument permitting enforcement in the State of the requested authority is contested by an interested party, the requested authority shall inform that party that such an action must be brought by the latter before the competent body of the State of the applicant authority in accordance with the laws in force there.

2. Disputes concerning enforcement measures taken in the State of the requested authority or concerning the validity of a notification made by an authority of the requested State shall be brought before the competent body of that State in accordance with its laws and regulations.

3. Where an action as referred to in paragraph 1 has been brought, the applicant authority shall inform the requested authority thereof and shall indicate the extent to which the claim is not contested.

4. As soon as the requested authority has received the information referred to in paragraph 3, either from the applicant authority or from the interested party, it shall suspend the enforcement procedure, as far as the contested part of the claim is concerned, pending the decision of the body competent in the matter, unless the applicant authority requests otherwise in accordance with the third subparagraph of this paragraph.



At the request of the applicant authority, or where otherwise deemed to be necessary by the requested authority, and without prejudice to Article 31 [Request for precautionary measures], the requested authority may take precautionary measures to guarantee recovery in so far as the applicable laws or regulations allow.

The applicant authority may, in accordance with the laws, regulations and administrative practices in force in its State, ask the requested authority to recover a contested claim or the contested part of a claim, in so far as the laws, regulations and administrative practices in force in the State of the requested authority allow. Any such request shall be reasoned. If the result of contestation is subsequently favourable to the debtor, the applicant authority shall be liable for reimbursing any sums recovered, together with any compensation due, in accordance with the laws in force in the State of the requested authority.

If a mutual agreement procedure has been initiated between the State of the applicant authority and the State of requested authority, and the outcome of the procedure may affect the claim in respect of which assistance has been requested, the recovery measures shall be suspended or stopped until that procedure has been terminated, unless it concerns a case of immediate urgency because of fraud or insolvency. If the recovery measures are suspended or stopped, the second subparagraph shall apply.

#### Article 30: Amendment or withdrawal of the request for recovery assistance

1. The applicant authority shall inform the requested authority immediately of any subsequent amendment to its request for recovery or of the withdrawal of its request, indicating the reasons for amendment or withdrawal.
2. If the amendment of the request is caused by a decision of the competent body referred to in paragraph 1 of Article 29 [Disputed claims and enforcement measures], the applicant authority shall communicate this decision together with a revised uniform instrument permitting enforcement in the State of the requested authority. The requested authority shall then proceed with further recovery measures on the basis of the revised instrument.

Recovery or precautionary measures already taken on the basis of the original uniform instrument permitting enforcement in the State of the requested authority may be continued on the basis of the revised instrument, unless the amendment of the request is due to invalidity of the initial instrument permitting enforcement in the State of the applicant authority or the original uniform instrument permitting enforcement in the State of the requested authority.

Articles 27 [Instruments permitting enforcement in the State of the requested authority and other accompanying documents] and 29 [Disputed claims and enforcement measures] shall apply in relation to the revised instrument.

#### Article 31: Request for precautionary measures

1. At the request of the applicant authority, the requested authority shall take precautionary measures, if allowed by its national law and in accordance with its administrative practices, to ensure recovery where a claim or the instrument permitting enforcement in the State of the applicant authority is contested at the time when the request is made, or where the claim is not yet the subject of an instrument permitting enforcement in the State of the applicant authority, in so far as precautionary measures are possible in a similar situation under the law and administrative practices of the State of the applicant authority.

The document drawn up for permitting precautionary measures in the State of the applicant authority and relating to the claim for which mutual assistance is requested, if any, shall be attached to the request for precautionary measures in the State of the requested authority. This document shall not be subject to any act of recognition, supplementing or replacement in the State of the requested authority.

2. The request for precautionary measures may be accompanied by other documents relating to the claim.

#### Article 32: Rules governing the request for precautionary measures

In order to give effect to Article 31 [Request for precautionary measures], paragraph 2 of Article 25 [Request for recovery], paragraphs 1 and 2 of Article 28 [Execution of the request for recovery], Articles 29 [Disputed claims and enforcement measures] and 30 [Amendment or withdrawal of the request for recovery assistance] shall apply *mutatis mutandis*.

#### Article 33: Limits to the requested authority's obligation

1. The requested authority shall not be obliged to grant the assistance provided for in Articles 25 [Request for recovery] to 31 [Request for precautionary measures] if recovery of the claim would, because of the situation of the debtor, create serious economic or social difficulties in the State of the requested authority, in so far as the laws, regulations and administrative practices in force in that State allow such exception for national claims.

2. The requested authority shall not be obliged to grant the assistance provided for in Articles 25 [Request for recovery] to 31 [Request for precautionary measures] where the costs or administrative burdens for the requested State would be clearly disproportionate to the monetary benefit to be derived by the applicant State.

3. The requested authority shall not be obliged to grant the assistance provided for in Article 20 [Request for information] and Articles 22 [Presence in administrative offices and participation in administrative enquiries] to 31 [Request for precautionary measures] if the initial request for assistance pursuant to Article 20 [Request for information], 22 [Presence in administrative offices and participation in administrative enquiries], 23 [Request for notification of certain documents relating to claims], 25 [Request for recovery] or 31 [Request for precautionary measures] is made in respect of claims which are more than 5 years old, dating from the due date of the claim in the State of the applicant authority to the date of the initial request for assistance.

However, in cases where the claim or the initial instrument permitting enforcement in the State of the applicant authority is contested, the 5-year period shall be deemed to begin from the moment when it is established in the State of the applicant authority that the claim or the instrument permitting enforcement may no longer be contested.

Moreover, in cases where a postponement of the payment or payment by instalments arrangement has been granted by the State of the applicant authority, the 5-year period shall be deemed to begin from the moment when the entire extended payment period has come to its end.

However, in those cases the requested authority shall not be obliged to grant assistance in respect of claims which are more than 10 years old, dating from the due date of the claim in the State of the applicant authority.

4. A State shall not be obliged to grant assistance if the total amount for which assistance is requested is less than GBP 5000.
5. The requested authority shall inform the applicant authority of the grounds for refusing a request for assistance.

#### Article 34: Questions on limitation

1. Questions concerning periods of limitation shall be governed solely by the laws in force in the State of the applicant authority.
2. In relation to the suspension, interruption or prolongation of periods of limitation, any steps taken in the recovery of claims by or on behalf of the requested authority in pursuance of a request for assistance which have the effect of suspending, interrupting or prolonging the period of limitation according to the laws in force in the State of the requested authority shall have the same effect in the State of the applicant authority, on condition that the corresponding effect is provided for under the law of the latter State.

If suspension, interruption or prolongation of the period of limitation is not possible under the laws in force in the State of the requested authority, any steps taken in the recovery of claims by or on behalf of the requested authority in pursuance of a request for assistance which, if they had been carried out by or on behalf of the applicant authority in its own State, would have had the effect of suspending, interrupting or prolonging the period of limitation according to the laws of that State shall be deemed to have been taken in the latter State, in so far as that effect is concerned.

The first and second subparagraphs shall not affect the right of the State of the applicant authority to take measures which have the effect of suspending, interrupting or prolonging the period of limitation in accordance with the laws in force in that State.

3. The applicant authority and the requested authority shall inform each other of any action which interrupts, suspends or prolongs the limitation period of the claim for which the recovery or precautionary measures were requested, or which may have this effect.

#### Article 35: Costs

1. In addition to the amounts referred to in paragraph 5 of Article 28 [Execution of the request for recovery], the requested authority shall seek to recover from the person concerned and retain the costs linked to the recovery that it incurred, in accordance with the laws and regulations of its State.  
2. The States shall renounce all claims on each other for the reimbursement of costs arising from any mutual assistance they grant each other pursuant to this Protocol.
2. However, where recovery creates a specific problem, concerns a very large amount in costs or relates to organised crime, the applicant and requested authorities may agree reimbursement arrangements specific to the cases in question.
3. Notwithstanding paragraph 2, the State of the applicant authority shall be liable to the State of the requested authority for any costs and any losses incurred as a result of actions held to be unfounded, as far as either the substance of the claim or the validity of the instrument permitting enforcement and/or precautionary measures issued by the applicant authority are concerned.

#### Chapter four: General rules governing all types of recovery assistance requests

#### Article 36: Use of languages

1. All requests for assistance, standard forms for notification and uniform instruments permitting enforcement in the State of the requested authority shall be sent in, or shall be accompanied by a translation into, the official language, or one of the official languages, of the State of the requested authority. The fact that certain parts thereof are written in a language other than the official language, or one of the official languages, of that State, shall not affect their validity or the validity of the procedure, in so far as that other language is one agreed between the States concerned.
2. The documents for which notification is requested pursuant to Article 23 [Request for notification of certain documents relating to claims] may be sent to the requested authority in an official language of the State of the applicant authority.
3. Where a request is accompanied by documents other than those referred to in paragraphs 1 and 2, the requested authority may, where necessary, require from the applicant authority a translation of such documents into the official language, or one of the official languages of the State of the requested authority, or into any other language agreed between the States concerned.

#### Article 37: Statistical data

1. By 30 June each year, the Parties shall communicate by electronic means to the Specialised Committee the statistical data on the application of this Title.
2. The content and format of the statistical data to be communicated under paragraph 1 shall be determined by the Specialised Committee.

#### Article 38: Standard forms and means of communication

1. Requests pursuant to paragraph 1 of Article 20 [Request for information] for information, requests pursuant to paragraph 1 of Article 23 [Request for notification of certain documents relating to claims] for notification, requests pursuant to paragraph 1 of Article 25 [Request for recovery] for recovery or requests pursuant to paragraph 1 of Article 31 [Request for precautionary measures] for precautionary measures, and communication of statistical data pursuant to Article 37 [Statistical data] shall be sent by electronic means, using a standard form, unless this is impracticable for technical reasons. As far as possible, these forms shall also be used for any further communication with regard to the request.

The uniform instrument permitting enforcement in the State of the requested authority, the document permitting precautionary measures in the State of the applicant authority and the other documents referred to in Articles 27 [Instrument permitting enforcement in the State of the requested authority and other accompanying documents] and 31 [Request for precautionary measures] shall also be sent by electronic means, unless this is impracticable for technical reasons.

Where appropriate, the standard forms may be accompanied by reports, statements and any other documents, or certified true copies or extracts thereof, which shall also be sent by electronic means, unless this is impracticable for technical reasons.

Standard forms and communication by electronic means may also be used for the exchange of information pursuant to Article 21 [Exchange of information without prior request].

2. Paragraph 1 shall not apply to the information and documentation obtained through the presence of officials in administrative offices in another State or through participation in administrative enquiries in another State, in accordance with Article 22 [Presence in administrative offices and participation in administrative enquiries].

3. If communication is not made by electronic means or with use of standard forms, this shall not affect the validity of the information obtained or of the measures taken in the execution of a request for assistance.

4. The electronic communication network and the standard forms adopted for the implementation of this Protocol may also be used for recovery assistance regarding other claims than the claims referred to in point (b) of paragraph 1 of Article 2 [Scope], if such recovery assistance is possible under other bilateral or multilateral legally binding instruments on administrative cooperation between the States.

5. Pending the adoption by the Specialised Committee of the decisions referred to in paragraph 2 of Article 39 [Trade Specialised Committee on Administrative Cooperation in VAT and Recovery of Taxes and Duties], the competent authorities shall make use of the rules set out in the Annex to this Protocol, including the standard forms.

6. The State of the requested authority shall use its official currency for the transfer of the recovered amounts to the State of the applicant authority, unless otherwise agreed between the States concerned.

#### *TITLE IV: IMPLEMENTATION AND APPLICATION*

##### Article 39: Trade Specialised Committee on Administrative cooperation in VAT and Recovery of Taxes and Duties

1. The Specialised Committee shall:

- (a) hold regular consultations; and
- (b) review the operation and effectiveness of this Protocol at least every 5 years.

2. The Specialised Committee shall adopt decisions or recommendations to:

- (a) determine the frequency of, the practical arrangements for and the exact categories of information subject to automatic exchange referred to in Article 11 [Automatic exchange of information];
- (b) review the result of the automatic exchange of information for each category established pursuant to point (a) of paragraph 2 so as to ensure that this type of exchange takes place only where it is the most efficient means for the exchange of information;
- (c) establish new categories of information to be exchanged pursuant to Article 11 [Automatic exchange of information], should the automatic exchange be the most efficient means of cooperation;

- (d) define the standard forms for the communications pursuant to paragraph 1 of Article 19 [Standard forms and means of communication] and paragraph 1 of Article 38 [Standard forms and means of communication];
- (e) review the availability, collection, and processing of statistical data referred to in Articles 18 [Statistical data] and 37 [Statistical data], so as to ensure that the obligations set out in those Articles do not impose a disproportionate administrative burden on the Parties;
- (f) establish what shall be transmitted via the CCN/CSI network or other means;
- (g) determine the amount and the modalities of the financial contribution to be made by the United Kingdom to the general budget of the Union in respect of the cost generated by its participation in the European information systems, taking into account the decisions referred to in points (d) and (f);
- (h) establish implementing rules on the practical arrangements with regard to the organisation of the contacts between the central liaison offices and liaison departments referred to in paragraphs 2 and 3 of Article 4 [Organisation];
- (i) establish the practical arrangements between the central liaison offices for the implementation of paragraph 5 of Article 4 [Organisation];
- (j) establish implementing rules for Title III [Recovery assistance], including rules on the conversion of the sums to be recovered and the transfer of sums recovered; and
- (k) establish the procedure for concluding the service level agreement referred to in Article 5 [Service level agreement] and also conclude that service level agreement.

#### *TITLE V: FINAL PROVISIONS*

##### Article 40: Execution of on-going requests

1. Where requests for information and for administrative enquiries sent in accordance with Regulation (EU) No 904/2010 in relation to the transactions covered by Article 99(1) of the Withdrawal Agreement are not yet closed within four years after the end of the transition period, the requested State shall ensure that those requests are executed in accordance with the rules of this Protocol.

2. Where assistance requests relating to taxes and duties within the scope of Article 2 [Scope] of this Protocol sent in accordance with Directive 2010/24/EU in relation to the claims referred to in Article 100(1) of the Withdrawal Agreement are not closed within five years after the end of the transition period, the requested State shall ensure that those assistance requests are executed in accordance with the rules of this Protocol. The standard uniform form for notification or the instrument permitting enforcement in the requested State established in accordance with the legislation referred to in this paragraph shall retain its validity for the purposes of such execution. A revised uniform instrument permitting enforcement in the requested State may be established after the end of that five year period in relation to claims for which assistance was requested before that time. Such revised uniform instruments shall refer to the legal basis used for the initial assistance request.

#### Article 41: Relation to other agreements or arrangements

This Protocol shall take precedence over the provisions of any bilateral or multilateral agreements or arrangements on administrative cooperation in the field of VAT, or on recovery assistance relating to the claims covered by this Protocol, which have been concluded between Member States and the United Kingdom, insofar as their provisions are incompatible with those of this Protocol.

**ANNEX TO THE PROTOCOL ON ADMINISTRATIVE COOPERATION AND COMBATING FRAUD IN THE FIELD OF VALUE ADDED TAX AND ON MUTUAL ASSISTANCE FOR THE RECOVERY OF CLAIMS RELATING TO TAXES AND DUTIES**

Pending the adoption by the Specialised Committee of the decisions referred to in paragraph 2 of Article 39 [Trade Specialised Committee on Administrative Cooperation in VAT and Recovery of Taxes and Duties] of the Protocol on administrative cooperation and combating fraud in the field of Value Added Tax and on mutual assistance for the recovery of claims relating to taxes and duties (the "Protocol"), the following rules and standard forms apply.

*Section 1 : Organisation of contacts*

1.1. Until further notice, the central liaison offices having the principal responsibility for the application of Title II [Administrative Cooperation and Combating VAT Fraud] of the Protocol are:

- (a) for the United Kingdom: Her Majesty's Revenue and Customs, UK VAT Central Liaison Office;
- (b) for the Member States: the central liaison offices designated for administrative cooperation between the Member States in the area of VAT.

1.2. Until further notice, the central liaison offices having the principal responsibility for the application of Title III [Recovery assistance] of this Protocol are:

- (a) for the United Kingdom: Her Majesty's Revenue and Customs, Debt Management;
- (b) for the Member States: the central liaison offices designated for recovery assistance between the Member States.

*Section 2 : Administrative cooperation and combating fraud in the field of Value Added Tax*

2.1. Communication

The communication of information under Title II [Administrative Cooperation and Combating VAT Fraud] of this Protocol shall be done, as far as possible, by electronic means and via the Common Communication Network (CCN), between the respective mailboxes of the States for the exchange of information on administrative cooperation or the mailboxes for combating fraud in the field of VAT.

2.2. Standard form

For the exchange of information under Title II [Administrative Cooperation and Combating VAT Fraud] of this Protocol, the States shall use the following model:



**Standard form for requests for information, for spontaneous exchange of information and for feedback between the EU Member States and the United Kingdom under the Protocol on administrative cooperation and combating fraud in the area of VAT**

**Exchange of information reference:**

<b>A) BASIC INFORMATION</b>	
A1	
Requesting state:	<i>Requested state:</i>
Requesting authority:	<i>Requested authority:</i>
A2	
Official dealing with the request/exchange in the requesting authority:	<i>Official dealing with the reply to the request/exchange in the requested authority:</i>
Name:	<i>Name:</i>
Email:	<i>Email:</i>
Telephone:	<i>Telephone:</i>
Language:	<i>Language:</i>
A3	
Requesting authority national reference:	<i>Requested authority national reference:</i>
Space reserved for the requesting authority:	<i>Space reserved for the requested authority:</i>
A4	
Date of transmission of the request/exchange:	<i>Date of transmission of the reply:</i>
A5	
No of attachments to the request/exchange:	<i>No of attachments to the reply:</i>
A6	
A7	
<input type="radio"/> General request/exchange	<input type="checkbox"/> <i>I, requested authority, will not be able to reply within the following deadlines:</i>
<input type="radio"/> Request for information	<input type="radio"/> <i>3 months</i>
<input type="radio"/> Spontaneous exchange of information	<input type="radio"/> <i>1 month for information that is already in my possession</i>
<input type="checkbox"/> Feedback on spontaneous exchange of information is requested	<i>Reason for delay:</i>

<input type="radio"/> Anti-fraud request/exchange		
<input type="radio"/> Request for information		
<input type="radio"/> Missing Trader Fraud - Registration control/Business activity		
<input type="radio"/> Spontaneous supply of information		
<input type="checkbox"/> Feedback on spontaneous information is requested		
	<input type="checkbox"/> <i>Expected time of reply:</i>	
	<input type="checkbox"/> <i>The requested authority of the state authorises the transmission of the information to another state (Article 6(6) of the Protocol on administrative cooperation and combating fraud in the field of Value Added Tax and on mutual assistance for the recovery of claims relating to taxes and duties)</i>  <input type="checkbox"/> <i>Feedback on the reply is requested</i>	
<p>Pursuant to Article 6(4) of the Protocol on administrative cooperation and combating fraud in the field of Value Added Tax and on mutual assistance for the recovery of claims relating to taxes and duties, the state providing the information shall, on the basis of a reasoned request, permit the use of the information received for purposes other than those referred to in Article 2(1) of the Protocol.</p>		
<b>B) REQUEST FOR GENERAL INFORMATION</b>		
<b>Requesting authority</b>	<b>Requested authority</b>	<b>Requested authority<sup>161</sup></b>
B1 VAT identification number (if not, tax identification number)	B1 VAT identification number (if not, tax identification number) <input type="radio"/> Please fill in <input type="radio"/> Please confirm	<input type="radio"/> <i>I confirm</i> <input type="radio"/> <i>I do not confirm</i>
VAT number:	VAT number:	VAT number:
<input type="checkbox"/> VAT number not available	<input type="checkbox"/> VAT number not available	<input type="checkbox"/> <i>VAT number not available</i>
Tax identification number:	Tax identification number:	<i>Tax identification number:</i>
B2 Name	B2 Name	

161 In this third column, the requested authority either fills in the information requested by the requesting authority (box "please fill in" ticked in the second column) or confirms the veracity of the information provided by the requesting authority (box "please confirm" ticked and information provided in the second column).

	<input type="radio"/> Please fill in  <input type="radio"/> Please confirm	<input type="radio"/> I confirm <input type="radio"/> I do not confirm  <i>Name:</i>
B3 Trading name	B3 Trading name  <input type="radio"/> Please fill in  <input type="radio"/> Please confirm	<input type="radio"/> I confirm <input type="radio"/> I do not confirm  <i>Trading name:</i>
B4 Address	B4 Address  <input type="radio"/> Please fill in  <input type="radio"/> Please confirm	<input type="radio"/> I confirm <input type="radio"/> I do not confirm  <i>Address:</i>
B5 The following dates in the format (YYYY/MM/DD):	B5 The following dates in the format (YYYY/MM/DD):  <input type="radio"/> Please fill in <input type="radio"/> Please confirm	<input type="radio"/> I confirm <input type="radio"/> I do not confirm
(a) issue of the VAT/tax identification number	(a) issue of the VAT/tax identification number	<i>(a) issue of the VAT/tax identification number</i>
(b) cancellation of the VAT/tax identification number	(b) cancellation of the VAT/tax identification number	<i>(b) cancellation of the VAT/tax identification number</i>
(c) Incorporation	(c) Incorporation	<i>(c) Incorporation</i>
B6 Date of commencement of activity	B6 Date of commencement of activity  <input type="radio"/> Please fill in  <input type="radio"/> Please confirm  Date of commencement of activity	<input type="radio"/> I confirm <input type="radio"/> I do not confirm  <i>Date of commencement of activity</i>

B7 Date of cessation of activity	B7 Date of cessation of activity  <input type="radio"/> Please fill in  <input type="radio"/> Please confirm  Date of cessation of activity	  <input type="radio"/> I confirm <input type="radio"/> I do not confirm  <i>Date of cessation of activity</i>
B8 Names of the managers/directors	B8 Names of the managers/directors  <input type="radio"/> Please fill in  <input type="radio"/> Please confirm	  <input type="radio"/> I confirm <input type="radio"/> I do not confirm
B9 Names of the owners, proprietors, associates, partners, agents, stakeholders or persons having other rights in the business	B9 Names of the owners, proprietors, associates, partners, agents, stakeholders or persons having other rights in the business  <input type="radio"/> Please fill in  <input type="radio"/> Please confirm	  <input type="radio"/> I confirm <input type="radio"/> I do not confirm
B10 Nature of the activity	B10 Nature of the activity  <input type="radio"/> Please fill in  <input type="radio"/> Please confirm	  <input type="radio"/> I confirm <input type="radio"/> I do not confirm
(a) Legal status of the business	(a) Legal status of the business	<i>(a) Legal status of the business</i>
(b) Actual principal activity <sup>162</sup>	(b) Actual principal activity	<i>(b) Actual principal activity</i>
B11 Nature of the transaction	Nature of the transaction  B11 Goods/services involved  <input type="radio"/> Please fill in  <input type="radio"/> Please confirm	<i>Nature of the transaction</i>  <i>B11 Goods/services involved</i>  <input type="radio"/> I confirm <input type="radio"/> I do not confirm

162 Actual principal activity means the real main activity carried out by the business (as opposed to another possibly declared one).

<b>Period and amount to which the request/exchange relates</b>		
B12 Supply of goods from one country to another		
From	<b>Period</b>	<b>Period</b>
To	<b>Amount</b>	<b>Amount</b>
Sources: <input type="checkbox"/> VAT information exchange system (VIES) <input type="checkbox"/> Other		
B13 Supply of services from one country to another		
From	<b>Period</b>	<b>Period</b>
To	<b>Amount</b>	<b>Amount</b>
Sources: <input type="checkbox"/> VIES <input type="checkbox"/> Other		
<b>C) ADDITIONAL INFORMATION</b>		
<b>Registration</b>		
<input type="checkbox"/> C1 The taxable person in the requested state ( <input type="checkbox"/> ) / the taxable person in the requesting state ( <input type="checkbox"/> ) is currently not identified for VAT purposes. According to the VIES or other sources, supplies have been made after the date of cessation of the activity. Please explain.		
<input type="checkbox"/> C2 The taxable person in the requested state ( <input type="checkbox"/> ) / the taxable person in the requesting state ( <input type="checkbox"/> ) is not identified for VAT purposes. According to the VIES or other sources, supplies have been made before the date of registration. Please explain.		
<b>Transactions of goods/services</b>		

**Goods**

C3 According to the VIES or other sources, the taxable person in the requested state made supplies of goods but the taxable person in the requesting state either:

- did not declare a purchase of the goods;
- denies receipt of the goods;
- declared a purchase for a different amount and the declared amount is:  
Please investigate and explain.

I attach copies of documents in my possession.

C4 The purchase declared by the taxable person in the requesting state does not correspond with the information from VIES or other sources. Please investigate and explain.

C5 Please provide the addresses where the goods were delivered.

Addresses:

C6 The taxable person in the requesting state claims to have made supply to a person in the requested state. Please confirm that the goods were received and whether they were:

accounted for:

Yes  No

declared/paid by a taxable person in the requested state

Yes  No

Name and/or VAT identification number of the taxable person in the requested state.

**Prior/onward movement of the goods**

C7 From whom were the goods purchased? Please provide names, trading names and VAT numbers in box C40.

C8 To whom were the goods sold on? Please provide names, trading names and VAT numbers in box C40.

**Services**

C9 According to the VIES or other sources, the taxable person in the requested state made supplies of services taxable in the requesting state but the taxable person in the requesting state either:

- did not declare the service;
- denies having received the service;
- declared having receiving the service for a different amount and the declared amount is:  
Please investigate and explain.

I attach copies of documents in my possession.

C10 The a purchase declared by the taxable person in the requesting state do not correspond with the information from the

VIIES or other sources. Please investigate and explain.

C11 Please provide the addresses where the services were provided.

*Addresses:*

C12 The taxable person in the requesting state claims to have made supply to a person in the requested state. Please confirm that the services were provided and whether they were:

accounted for:

Yes  No

declared/paid by a taxable person in the requested state:

Yes  No

Name and/or VAT identification number of the taxable person in the requested state.

**Transport of goods**

C13 Please provide the name/VAT identification number and the address of the transporter.

*Name and/or VAT identification number and address:*

C14 Who ordered and paid the transportation of the goods?

*Name and/or VAT identification number and address:*

C15 Who is the owner of the means of transport used?

*Name and/or VAT identification number and address:*

**Invoices**

C16 Please provide the amount invoiced and currency.

<b>Payment</b>
<input type="checkbox"/> C17 Please provide the amount paid and currency.
<input type="checkbox"/> C18 Please provide the name of the bank account holder and the number of the account from which and/or to which the payment was made.
<i>From:</i>  <i>Name of the account holder:</i>  <i>IBAN number or account number:</i>  <i>Bank:</i>  <i>To:</i>  <i>Name of the account holder:</i>  <i>IBAN number or account number:</i>  <i>Bank:</i>
<input type="checkbox"/> C19 Please provide the following details where the payment was made in cash:  <input type="checkbox"/> Who handed over the money, to whom, where and when? <input type="checkbox"/> What document (cash receipt, etc.) was issued confirming the payment? <input type="checkbox"/> C20 Is there any evidence of third party payments? If yes, please provide additional information in box C40 <input type="checkbox"/> Yes <input type="checkbox"/> No
<b>Placing of an order</b>
<input type="checkbox"/> C21 Please furnish all available details of the person placing the order, how the order was placed and how the contact was established  between the supplier and the customer.
<b>Goods covered by special schemes/particular procedures</b>
Please tick the appropriate box and enter your question in box C40
<input type="checkbox"/> C22 Triangular transactions.
<input type="checkbox"/> C23 Margin scheme.
<input type="checkbox"/> C24 Distance sales of goods  <input type="checkbox"/> covered by the Union scheme  <input type="checkbox"/> covered by the Import scheme
<input type="checkbox"/> C25 New means of transport sold to non-taxable persons.



C26 Exemption under Customs Procedure 42XX / 63XX.

C27 Gas and electricity.

C28 Call-off stock arrangements.

C29 Others:

#### **Services covered by particular provisions**

Please tick the appropriate box and enter your question in box C40

C30 Supply of services provided by an intermediary.

C31 Supply of services connected to immovable property.

C32 Supplies of passenger transport.

C33 Supplies of transport of goods.

C34 Supply of cultural, artistic, sporting, scientific, educational, entertainment and similar services, ancillary transport services and valuations of and work on movable tangible property.

C35 Supply of restaurant and catering services other than as provided for at C37.

C36 Supply of transport hire.

C37 Supply of restaurant and catering services for consumption on board of ships, aircraft or trains.

C38 Supply of services

covered by the non-Union scheme

covered by the Union scheme

C39 Services for which effective use and enjoyment rules are applied.

#### **C40 Background information and further questions**

#### **C41 Free text reply box**

#### **D) REQUEST FOR DOCUMENTS**

Please provide copies of the following documents (where applicable see amount and period in part B12 and B13)		
<input type="checkbox"/> D1 Invoices	<input type="radio"/> <i>Provided</i>	<input type="radio"/> <i>Not available</i>
<input type="checkbox"/> D2 Contracts	<input type="radio"/> <i>Provided</i>	<input type="radio"/> <i>Not available</i>
<input type="checkbox"/> D3 Orders	<input type="radio"/> <i>Provided</i>	<input type="radio"/> <i>Not available</i>
<input type="checkbox"/> D4 Evidence of payments	<input type="radio"/> <i>Provided</i>	<input type="radio"/> <i>Not available</i>
<input type="checkbox"/> D5 Transport documentation	<input type="radio"/> <i>Provided</i>	<input type="radio"/> <i>Not available</i>
<input type="checkbox"/> D6 Creditor's ledger for the taxable person in the requesting state	<input type="radio"/> <i>Provided</i>	<input type="radio"/> <i>Not available</i>
<input type="checkbox"/> D7 Debtor's ledger for the taxable person in the requesting state	<input type="radio"/> <i>Provided</i>	<input type="radio"/> <i>Not available</i>
<input type="checkbox"/> D8 Call-off stock registers  From                              To	<input type="radio"/> <i>Provided</i>	<input type="radio"/> <i>Not available</i>
<input type="checkbox"/> D9 One-stop-shop/import one-stop-shop records  From                              To	<input type="radio"/> <i>Provided</i>	<input type="radio"/> <i>Not available</i>
<input type="checkbox"/> D10 Bank account statements  From                              To	<input type="radio"/> <i>Provided</i>	<input type="radio"/> <i>Not available</i>
<input type="checkbox"/> D11 Others	<input type="radio"/> <i>Provided</i>	<input type="radio"/> <i>Not available</i>

**E) SPONTANEOUS SUPPLY OF INFORMATION (GENERAL)**

- E1 Based on the records of the taxable person in the sending state, it appears that they should be registered in the receiving state.
- E2 According to the records of the taxable person in the sending state,  goods /  services were supplied to them by a taxable person in the receiving state, but no information is available via the VIES/Customs or other sources data.
- E3 According to the records of the taxable person in the sending state, VAT is to be paid on goods supplied to the receiving state, but no data was entered into VIES/Customs or other sources data.
- E4 According to the VIES/Customs or other sources data, the taxable person in the receiving state made supplies to a taxable person in the sending state but the latter taxable person either:
- did not declare a purchase of  goods / receipt of  services;
- denies the purchase of the  goods / receipt of  services.

<input type="checkbox"/> E5 According to the records of the taxable person in the sending state, VAT is to be paid on services supplied in the receiving state.		
<input type="checkbox"/> E6 Background and additional information:		
<input type="checkbox"/> E7 I attach copies of invoices in my possession.		
<b>F) MISSING TRADER FRAUD: REGISTRATION CONTROL / BUSINESS ACTIVITY</b>		
<b>(A) Identification of the business</b>		
<b>Requesting authority</b>	<b>Requested authority</b>	<b><i>Requested authority</i></b> <sup>163</sup>
F1 VAT identification number (if not, tax identification number)  VAT number:	F1 VAT identification number (if not, tax identification number)  <input type="radio"/> Please fill in  <input type="radio"/> Please confirm  VAT number:	     <input type="radio"/> I confirm <input type="radio"/> I do not confirm  VAT number:
<input type="checkbox"/> VAT number not available	<input type="checkbox"/> VAT number not available	<input type="checkbox"/> VAT number not available
Tax identification number:	Tax identification number:	<i>Tax identification number:</i>
F2 Name	F2 Name  <input type="radio"/> Please fill in  <input type="radio"/> Please confirm	     <input type="radio"/> I confirm <input type="radio"/> I do not confirm  <i>Name:</i>
F3 Address	F3 Address  <input type="radio"/> Please fill in  <input type="radio"/> Please confirm	     <input type="radio"/> I confirm <input type="radio"/> I do not confirm  <i>Address:</i>
F4 The following dates in the format (YYYY/MM/DD):	F4 The following dates in the format (YYYY/MM/DD):	

---

163 In this third column, the requested authority either fills in the information requested by the requesting authority (box "please fill in" ticked in the second column) or confirms the veracity of the information provided by the requesting authority (box "please confirm" ticked and information provided in the second column).

	<input type="radio"/> Please fill in  <input type="radio"/> Please confirm	<input type="radio"/> I confirm <input type="radio"/> I do not confirm
(a) issue of the VAT/tax identification number	(a) issue of the VAT/tax identification number	<i>(a) issue of the VAT/tax identification number</i>
(b) cancellation of the VAT/tax identification number	(b) cancellation of the VAT/tax identification number	<i>(b) cancellation of the VAT/tax identification number</i>
(c) Incorporation	(c) Incorporation	<i>(c) Incorporation</i>
F5 Owners, proprietors, associates, partners, agents, stakeholders or persons having other rights in the business	F5 Owners, proprietors, associates, partners, agents, stakeholders or persons having other rights in the business  <input type="radio"/> Please fill in  <input type="radio"/> Please confirm	<input type="radio"/> I confirm <input type="radio"/> I do not confirm
(a) Name	(a) Name	<i>(a) Name</i>
(b) Address	(b) Address	<i>(b) Address</i>
(c) Date of birth	(c) Date of birth	<i>(c) Date of birth</i>
(d) Nationality	(d) Nationality	<i>(d) Nationality</i>
F6 Managers/directors	F6 Managers/directors  <input type="radio"/> Please fill in  <input type="radio"/> Please confirm	<input type="radio"/> I confirm <input type="radio"/> I do not confirm
(a) Name	(a) Name	<i>(a) Name</i>
(b) Address	(b) Address	<i>(b) Address</i>

(c) Date of birth	(c) Date of birth	(c) <i>Date of birth</i>
(d) Nationality	(d) Nationality	(d) <i>Nationality</i>
<b>(B) Information requested</b>		
<input type="checkbox"/> F7 Are the persons referred to in F5 and F6 (with date of birth if known) contained in any of your databases?	<input type="radio"/> Yes <input type="radio"/> No	
<input type="checkbox"/> F8 Do those persons referred to in F5 and F6 have a financial criminal record?	<input type="checkbox"/> <i>The information cannot be given for legal reasons.</i> <input type="radio"/> Yes <input type="radio"/> No	
<input type="checkbox"/> F9 Do those persons referred to in F5 and F6 have a history of involvement in missing trader fraud or other type of fraud?	<input type="checkbox"/> <i>The information cannot be given for legal reasons.</i> <input type="radio"/> Yes <input type="radio"/> No	
<input type="checkbox"/> F10 Are those persons referred to in F5 and F6 either resident at or connected with the address given?	<input type="radio"/> Yes <input type="radio"/> No	
<input type="checkbox"/> F11 Is the stated address residential/business/temporary accommodation/accountant/other?	<input type="radio"/> Yes <input type="radio"/> No	
<input type="checkbox"/> F12 What is the business activity?		
<input type="checkbox"/> F13 Is the business's tax compliance suspect?	<input type="radio"/> Yes <input type="radio"/> No	
<input type="checkbox"/> F14 What is the reason for the cancellation of the VAT number?		
<input type="checkbox"/> F15 Please advise of any associated business <sup>164</sup> including their VAT identification numbers and any views as to their credibility.		
<input type="checkbox"/> F16 Please provide details of known bank accounts of the business in the requested state and any associated businesses.		

---

164 This is any business with common directors or other legal, economic or financial links with the business referred to in Heading A.

<input type="checkbox"/> F17 Please provide information from recapitulative statements or from Customs declarations on the supplies/purchases of goods/services for the year(s):	
<input type="checkbox"/> F18 Please provide information from VAT declarations/about payments for the year(s):	
<input type="checkbox"/> F19 Any additional comments:	

<b>G) SPONTANEOUS SUPPLY OF INFORMATION (MISSING TRADER FRAUD)</b>	
<b>Sending authority</b>	<b>Receiving authority</b>
<b>Identification of the business</b>	<b>Identification of the business</b>
G1 VAT identification number (if not, tax identification number)	G1 VAT identification number (if not, tax identification number)
VAT number:	VAT number:
<input type="checkbox"/> VAT number not available	<input type="checkbox"/> VAT number not available
Tax identification number:	Tax identification number:
G2 Name	G2 Name
G3 Address	G3 Address
G4 The following dates in the format (YYYY/MM/DD):	G4 The following dates in the format (YYYY/MM/DD):
(a) issue of the VAT/tax identification number	(a) issue of the VAT/tax identification number
(b) cancellation of the VAT/tax identification number	(b) cancellation of the VAT/tax identification number
(c) Incorporation	(c) Incorporation
G5 Owners, proprietors, associates, partners, agents, stakeholders or persons having other rights in the business	G5 Owners, proprietors, associates, partners, agents, stakeholders or persons having other rights in the business
(a) Name	(a) Name
(b) Address	(b) Address
(c) Date of birth	(c) Date of birth
(d) Nationality	(d) Nationality

G6 Managers, directors	G6 Managers, directors
(a) Name	(a) Name
(b) Address	(b) Address
(c) Date of birth	(c) Date of birth
(d) Nationality	(d) Nationality
Any additional comments	

**H) FEEDBACK<sup>165</sup>**

**Results related to the information provided:**

**1) The information provided:**

Resulted in an additional assessment of VAT or of other taxes. Please provide details on the type and amount of tax assessed:

Type of tax:

Additional assessment:

Penalty:

- Resulted in VAT registration.
- Resulted in VAT deregistration.
- Resulted in the cancellation of a VAT number from VIES or from VAT registered taxpayer's database.
- Resulted in the correction of VAT declarations.
- Led to a desk enquiry.
- Led to a new audit procedure or was used as part of an on-going audit.
- Led to a fraud investigation.
- Resulted in a request for information.

---

165 To be provided by the competent authority receiving the information.”



- Led to a presence in administrative office or to participation in administrative enquiry.
- Led to Multilateral control (MLC).
- Resulted in other actions:

Did not result in any substantial action.

**2) Other comments:**

Date of transmission:

### *Section 3 : Recovery assistance*

#### Article 3.1: Communication

A request sent by electronic means for the application of Title III of the Protocol shall be sent between the CCN mailboxes that are set up for the type of tax or duty to which the request relates, unless the central liaison offices of the applicant and requested States agree that one of the mailboxes can be used for requests concerning different types of taxes or duties.

However, if a request for notification of documents relates to more than one type of tax or duty, the applicant authority shall send that request to a mailbox set up for at least one of the types of claims mentioned in the documents to be notified.

#### Article 3.2: Implementing rules relating to the uniform instrument permitting enforcement in the requested State

1. The administrative penalties, fines, fees and surcharges and the interest and costs referred to in point (b) of paragraph 1 of Article 2 of the Protocol which, in accordance with the rules in force in the applicant State, may be due from the date of the initial instrument permitting enforcement until the day before the date on which the recovery request is sent, may be added in the uniform instrument permitting enforcement in the requested State.

2. A single uniform instrument permitting enforcement in the requested State may be issued in respect of several claims and several persons, corresponding to the initial instrument or instruments permitting enforcement in the applicant State.

3. In so far as initial instruments permitting enforcement for several claims in the applicant State have already been replaced by a global instrument permitting enforcement for all those claims in that State, the uniform instrument permitting enforcement in the requested State may be based on the initial instruments permitting enforcement in the applicant State or on that global instrument regrouping those initial instruments in the applicant State.

4. Where the initial instrument referred to in paragraph 2 or the global instrument referred to in paragraph 3 contains several claims, one or more of which have already been collected or

recovered, the uniform instrument permitting enforcement in the requested State shall only refer to those claims for which recovery assistance is requested.

5. Where the initial instrument referred to in paragraph 2 or the global instrument referred to in paragraph 3 contains several claims, the applicant authority may list those claims in different uniform instruments permitting enforcement in the requested State, in line with the tax type related division of competences of the respective recovery offices in the requested State.

6. If a request cannot be transmitted by CCN network and is transmitted by post, the uniform instrument permitting enforcement in the requested State shall be signed by a duly authorised official of the applicant authority.

#### Article 3.3: Conversion of the sums to be recovered

1. The applicant authority shall express the amount of the claim to be recovered in the currency of the applicant State and in the currency of the requested State.

2. For requests sent to the United Kingdom, the exchange rate to be used for the purposes of the recovery assistance shall be the exchange rate published by the European Central Bank on the day before the date on which the request is sent. Where there is no such rate available on that date, the exchange rate used shall be the latest exchange rate published by the European Central Bank before the date the request is sent.

For requests sent to a Member State, the exchange rate to be used for the purposes of the recovery assistance shall be the exchange rate published by the Bank of England on the day before the date on which the request is sent. Where there is no such rate available on that date, the exchange rate used shall be the latest exchange rate published by the Bank of England before the date the request is sent.

3. In order to convert the amount of the claim resulting from the adjustment, referred to in paragraph 2 of Article 30 of the Protocol, into the currency of the State of the requested authority, the applicant authority shall use the exchange rate used in its initial request.

#### Article 3.4: Transfer of recovered amounts

1. The transfer of the recovered amounts shall take place within two months of the date on which recovery was effected, unless otherwise agreed between the States.

2. However, if recovery measures applied by the requested authority are contested for a reason not falling within the responsibility of the applicant State, the requested authority may wait to transfer any sums recovered in relation to the applicant State's claim, until the dispute is settled, if the following conditions are simultaneously fulfilled:

- (a) the requested authority finds it likely that the outcome of this contestation will be favourable to the party concerned; and
- (b) the applicant authority has not declared that it will reimburse the sums already transferred if the outcome of that contestation is favourable to the party concerned.

3. If the applicant authority has made a declaration to reimburse in accordance with point (b) of the second paragraph, it shall return the recovered amounts already transferred by the requested

authority within one month of the receipt of the request for reimbursement. Any other compensation due shall, in that case, be borne solely by the requested authority.

#### Article 3.5: Reimbursement of recovered amounts

The requested authority shall notify any action taken in the requested State for reimbursement of sums recovered or for compensation in relation to recovery of contested claims to the applicant authority immediately after the requested authority has been informed of such action.

The requested authority shall as far as possible involve the applicant authority in the procedures for settling the amount to be reimbursed and the compensation due. Upon receipt of a reasoned request from the requested authority, the applicant authority shall transfer the sums reimbursed and the compensation paid within two months of the receipt of that request.

#### Article 3.6: Standard forms

1. For the uniform notification form accompanying the request for notification, referred to in Article 23 of the Protocol, the States shall use the form established in accordance with model A.
2. For the uniform instrument permitting enforcement in the requested State, referred to in Article 27 of the Protocol, accompanying the request for recovery or the request for precautionary measures, or the revised uniform instrument permitting enforcement in the requested State, referred to in paragraph 2 of Article 30 of the Protocol, the States shall use the form established in accordance with model B.
3. For the request for information referred to in Article 20 of the Protocol, the States shall use the form established in accordance with model C.
4. For the request for notification referred to in Article 23 of the Protocol, the States shall use the form established in accordance with model D.
5. For the request for recovery or for precautionary measures referred to in Articles 25 and 31 of the Protocol, the States shall use the form established in accordance with model E.
6. Where forms are transmitted by electronic means, their structure and lay-out may be adapted to the requirements and possibilities of the electronic communication system, provided that the set of data and information contained therein is not substantially altered when compared to the models set out below.

## Model A

### Uniform notification form providing information about notified document(s)

#### (to be transmitted to the addressee of the notification) <sup>(1)</sup>

This document accompanies document(s) hereby notified by the competent authority of the following state: [name of requested state].

This notification concerns documents of the competent authorities of the following state: [name of applicant state], which asked for notification assistance, in accordance with Article 23 of the Protocol between the European Union and the United Kingdom on administrative cooperation and combating fraud in the field of Value Added Tax and on mutual assistance for the recovery of claims relating to taxes and duties.

#### A. ADDRESSEE OF THE NOTIFICATION

- Name

- Address (known or assumed)

- Other data relevant to the identification of the addressee

#### B. PURPOSE OF THE NOTIFICATION

This notification is intended:

- to inform the addressee about the document(s) to which this document is attached.
- to interrupt the period of limitation with regard to the claim(s) mentioned in the notified document(s).
- to confirm to the addressee, his/her obligation to pay the amounts mentioned under point D.

Please note that in case of non-payment, the authorities may take enforcement and/or precautionary measures to ensure the recovery of the claim(s). This may cause extra costs charged to the addressee.

You are the addressee of this notification, as you are considered to be:

- the principal debtor
- a co-debtor
- a person other than the (co-)debtor, liable for settlement of the taxes, duties and other measures, or for other claims relating to these taxes, duties and other measures, under the laws in force in the applicant State
- a person other than the (co-)debtor, holding assets belonging to, or having debts towards, the (co-)debtor or to any other person liable
- a third party which may become affected by enforcement measures concerning other persons  
(The following information will appear if the addressee of the notification is a person other than the (co-)debtor, holding assets belonging to, or having debts towards, the (co-)debtor or to any other person liable, or a third party which may become affected by enforcement measures concerning other persons:

The notified documents concern claims relating to taxes and duties, for which the following person(s) is (are) liable as

- the principal debtor: [name and address (known or assumed)]
- a co-debtor: [name and address (known or assumed)]

*a person other than the (co-)debtor, liable for settlement of the taxes, duties and other measures, or for other claims relating to these taxes, duties and other measures, under the laws in force in the applicant State: [name and address (known or assumed)]).*

The applicant authority of the applicant State (name of the applicant State) invited the competent authorities of the requested State (name of the requested State) to make this notification before [date]. Please note that this date is not specifically related to any period of limitation.

### **C. OFFICE(S) RESPONSIBLE FOR THE NOTIFIED DOCUMENT(S)**

Office responsible with regard to the attached document(s):

- Name:
- Address:
- Other contact details:
- Language(s) in which this office can be contacted:

Further information about  *the notified document(s)*  *and/or the possibility of contesting the obligations* can be obtained

*at the abovementioned office responsible with regard to the attached document(s), and/or*

*from the following office:*

- Name:
- Address:
- Other contact details:
- Language(s) in which this office can be contacted:

### **D. DESCRIPTION OF THE NOTIFIED DOCUMENT(S)**

Document [number]

- Reference number:
- Date of establishment:
- Nature of the notified document:
  - Tax assessment*
  - Payment order*
  - Decision following an administrative appeal*
  - Other administrative document:*
  - Judgment or order of:*
  - Other judicial document:*
- Name of the claim(s) concerned (in the language of the applicant State):
- Nature of the claim(s) concerned:

— *Amount of the claim(s) concerned:*

- Principal amount:*
- Administrative penalties and fines:*
- Interest up to [date]:*
- Costs up to [date]:*
- Fees for certificates and similar documents issued in connection with administrative procedures related to the claim mentioned under point [x]:*
- Total amount for this (these) claim(s):*

— *The amount mentioned under point [x] should be paid:*

- before:*
- within [number] days following the date of this notification*

- without any further delay*
- *This payment should be made to:*
  - *Holder of the bank account:*
  - *International Bank Account Number (IBAN):*
  - *Bank Identification Code (BIC):*
  - *Name of the bank:*
- *Reference to be used for the payment:*
- *The addressee can reply to the document(s) that is (are) hereby notified.*
  - Last day for replying:*
  - Time period for replying:*
    - *Name and address of the authority to whom a reply can be sent:*
- *Possibility of contesting:*
  - The period to contest the claim or the notified document(s) has already come to its end.*
  - Last day for contesting the claim:*
  - Time period to contest the claim: [number of days] following*
    - the date of this notification.*
    - the establishment of the notified document(s)*
    - another date:*
      - *Name and address of the authority where a contestation has to be submitted:*

*Please note that disputes concerning the claim, the instrument permitting enforcement or any other document originating from the authorities of the applicant State [name of applicant State], fall within the competence of the competent bodies of the applicant State [name of applicant State], in accordance with Article 29 of the above Protocol between the European Union and the United Kingdom.*

*Any such dispute is governed by the procedural and language rules applying in the applicant State [name of applicant State].*

- Please note that the recovery may begin before the end of the period within which the claim may be contested.*
- *Other information:*  
,

<sup>(1)</sup> The elements put in *Italic* are optional.

#### Model B

**Uniform instrument permitting enforcement of claims covered by Article 27 of the Protocol between the European Union and the United Kingdom on administrative cooperation and combating fraud in the field of Value Added Tax and on mutual assistance for the recovery of claims relating to taxes and duties <sup>(1)</sup>**

**UNIFORM INSTRUMENT PERMITTING ENFORCEMENT OF CLAIMS**

- *Date of issue:*
- *Reference number:*

**REVISED UNIFORM INSTRUMENT PERMITTING ENFORCEMENT OF CLAIMS**

- *Date of issue of the original uniform instrument:*
- *Date of revision:*
- *Reason for the revision:*
- judgment or order of [name of the Court] of [date]*
- administrative decision of [date]*
- *Reference number:*

State where this document is issued: [name of applicant State]

Recovery measures taken by the requested State are based on:

- a uniform instrument permitting enforcement, in accordance with Article 27 of the above Protocol.*
- a revised uniform instrument permitting enforcement, in accordance with Article 30 of the above Protocol (to take account of the decision of the competent body referred to in Article 29(1) of that Protocol).*

This document is the uniform instrument permitting enforcement (including precautionary measures). It concerns the claim(s) mentioned below, which remain(s) unpaid in the applicant State [name of applicant State]. The initial instrument for the enforcement of this/these claim(s) has been notified in so far as required under the national law of the applicant State [name of applicant State]. Disputes concerning the claim(s) fall exclusively within the competence of the competent bodies of the applicant State [name of applicant State], in accordance with Article 29 of the above Protocol. Any such action shall be brought before them in accordance with the procedural and language rules in force in the applicant State [name of applicant State].

## **DESCRIPTION OF THE CLAIM(S) AND THE PERSON(S) CONCERNED**

### **Identification of the claim(s) [number]**

1. Reference:
2. Nature of the claim(s) concerned:
3. Name of the tax/duty concerned:
4. Period or date concerned:
5. Date of establishment of the claim:
6. Date on which enforcement becomes possible:
7. Amount of the claim still due:
  - principal amount:*
  - administrative penalties and fines:*
  - interest till date before the day the request is sent:*
  - costs till date before the day the request is sent:*
  
  - total amount of this claim:*
8. Date of notification of the initial instrument permitting enforcement in the applicant State: (name of the applicant State):
  - Date:*
  - No date available*
9. Office responsible for the assessment of the claim:
  - *Name:*
  - *Address:*
  - *Other contact details:*
  - *Language(s) in which this office can be contacted:*
10. Further information concerning the claim or the possibilities for contesting the payment obligation can be obtained from:

- the office indicated above*
- the following office responsible for the Uniform instrument permitting enforcement:*
  - *Name:*
  - *Address:*
  - *Other contact details:*
  - *Language(s) in which this office can be contacted:*

#### **Identification of the person(s) concerned in the national instrument(s) permitting enforcement**

a) The following person is mentioned in the national instrument(s) permitting enforcement

- natural person*
- other*
  - *Name*
  - *Address (known or assumed)*
  - *Other data relevant to the identification of the addressee*
- Legal representative*
  - *Name*
  - *Address (known or assumed)*
  - *Other data relevant to the identification of the addressee*

*Cause of liability:*

- principal debtor*
- a co-debtor*
- a person other than the (co-)debtor, liable for settlement of the taxes, duties and other measures, or for other claims relating to these taxes, duties and other measures under the laws in force in the applicant State*

b) the following person(s) is (are) also mentioned in the national instrument(s) permitting enforcement:

- natural person*
- other*
  - *Name:*
  - *Address (known or assumed):*
  - *Other data relevant to the identification of the addressee:*
- Legal representative*
  - *Name:*
  - *Address (known or assumed):*
  - *Other data relevant to the identification of the addressee:*

*Cause of liability:*

- principal debtor*
- a co-debtor*
- a person other than the (co-)debtor, liable for settlement of the taxes, duties and other measures, or for other claims relating to these taxes, duties and other measures under the laws in force in the applicant State*

#### **Other information**

#### **Overall total amount of the claim(s)**

- *in the currency of the applicant State:*
- *in the currency of the requested State:*



*This document has been agreed between the European Union and the United Kingdom and is provided for information only. No rights may be derived from it until the date of application. The numbering of the articles is provisional.*

<sup>(1)</sup> The elements put in Italic are optional.

### Model form C - request for information

REQUEST	FOR	INFORMATION
<p>Based on Article 20 of the Protocol between the European Union and the United Kingdom on administrative cooperation and combating fraud in the field of Value Added Tax and on mutual assistance for the recovery of claims relating to taxes and duties</p> <p><b>Reference: AA_RA_aaaaaaaaa_rrrrrrrrrrr_20YYMMDD_xxxxxxx_RI</b></p>		

Nature of the claim(s):

1. STATE OF THE APPLICANT AUTHORITY		
<p><b>A. Applicant authority</b></p> <p><u>Country:</u>  <u>Name:</u>            Telephone:  <u>Reference of the file:</u>            Name of the official dealing with the request:            Language skills</p>		<p><b>B. Office initiating the request</b></p> <p>Name:            Address:            Postcode:            Town:            Telephone:            E-mail:            Reference of the file:            Name of the official dealing with the request:</p>

2. STATE OF THE REQUESTED AUTHORITY	
<p><b>A. Requested authority</b></p> <p><u>Country:</u>  <u>Name:</u>            Telephone:  <u>Reference of the file:</u>            Name of the official dealing with the request:            Language skills</p>	<p><b>B. Office handling the request</b></p> <p>Name:            Address:            Postcode:            Town:            Telephone:            E-mail:            Reference of the file:            Name of the official dealing with the request:</p>

**3. INFORMATION RELATING TO THE REQUEST**

- I, applicant authority, ask the requested authority not to inform the person(s) concerned about this request.
- I, applicant authority, confirm that the information to be received will be subject to the secrecy provisions defined in the legal basis quoted above.

#### 4. INFORMATION RELATING TO THE PERSON CONCERNED

##### A. Information is requested with regard to:

For natural persons:

First name(s):

Surname:

Maiden name (name at birth):

Date of birth:

Place of birth:

VAT number:

Tax Identification Number:

Other identification data:

Address of this person:  known —  assumed

- Street and number:

- Details of address:

- Postcode and town:

- Country:

Or for legal entities:

Company name:

Legal status:

VAT number:

Tax Identification Number:

Other identification data:

Address of this legal entity:  known —  assumed

- Street and number:

- Details of address:

- Postcode and town:

- Country:

Legal representative

Name:

Address of this legal representative:  known —  assumed

Street and number:

Details of address:

Postcode and town:

Country:

##### B. Liability: the person concerned is:

the principal debtor

a co-debtor

a person other than the (co-)debtor, liable for settlement of the taxes, duties and other measures, or for other claims relating to these taxes, duties and other measures under the laws in force in the applicant State;

a person other than the (co-)debtor, holding assets belonging to, or having debts towards, the (co-) debtor or to any other person liable.

a third party which may become affected by enforcement measures concerning other persons.

**C. Other relevant information concerning the above persons:**

- Bank account number(s)  
 - Bank account number (IBAN):  
 - Bank identification code (BIC):  
 - Name of the bank:
- Car information on 20YY/MM/DD  
 - car plate number:  
 - car brand:  
 - colour of the car:
- Estimated or provisional or  precise amount of the claim(s):  
 Other:

**5. INFORMATION REQUESTED**

- Information about the identity of the person concerned (for natural persons: full name, date and place of birth; for legal entities: company name and legal status)
- Information about the address
- Information about the income and assets for recovery
- Information about the heirs and/or legal successors
- Other:

**6. FOLLOW-UP OF THE REQUEST FOR INFORMATION**

<u>Date</u>	<u>Nr</u>	<u>Message</u>	<u>Applicant authority</u>	<u>Requested authority</u>
<i>date</i>	<b>1</b>	<input type="checkbox"/> I, requested authority, acknowledge receipt of the request.		
<i>date</i> <input type="checkbox"/> To be combined with acknowledgment	<b>2</b>	<input type="checkbox"/> I, requested authority, invite the applicant authority to complete the request with the following additional information:		
<i>date</i>	<b>3</b>	<input type="checkbox"/> I, requested authority, have not yet received the additional information required and will close your request if I do not receive this information before 20YY/MM/DD.		
<i>date</i>	<b>4</b>	<input type="checkbox"/> I, applicant authority, <input type="checkbox"/> <b>a</b> provide on request the following additional information:  <input type="checkbox"/> <b>b</b> am not able to provide the requested additional information (because: )		
<i>date</i>	<b>5</b>	<input type="checkbox"/> I, requested authority, acknowledge receipt of the additional information and am now in a position to proceed.		
<i>date</i>	<b>6</b>	<input type="checkbox"/> I, requested authority, do not provide assistance and close the case because:  <input type="checkbox"/> <b>a</b> I do not have competence for any of the claims to which the request relates. <input type="checkbox"/> <b>b</b> the claim is older than foreseen in the Protocol. <input type="checkbox"/> <b>c</b> the amount of the claim is below the threshold.  <input type="checkbox"/> <b>d</b> I am not able to obtain this information for the purpose of recovering similar national claims. <input type="checkbox"/> <b>e</b> this would disclose a commercial, industrial or professional secret. <input type="checkbox"/> <b>f</b> the disclosure of this information would be liable to prejudice the security or be contrary to the public policy of the State. <input type="checkbox"/> <b>g</b> the applicant authority did not provide all the required additional information. <input type="checkbox"/> <b>h</b> other reason:		
<i>date</i>	<b>7</b>	<input type="checkbox"/> I, applicant authority, ask to be informed about the present status of my request.		

<i>date</i>	<b>8</b>	I, requested authority, cannot provide the information now because: <input type="checkbox"/> I have asked information from other public bodies. <input type="checkbox"/> I have asked information from a third party. <input type="checkbox"/> I am arranging a personal call. <input type="checkbox"/> other reason:
<i>date</i>	<b>9</b>	The requested information cannot be obtained because: <input type="checkbox"/> <b>a</b> the person concerned is not known. <input type="checkbox"/> <b>b</b> insufficient data for identification of person concerned. <input type="checkbox"/> <b>c</b> the person concerned has moved away, address unknown. <input type="checkbox"/> <b>d</b> the requested information is not available. <input type="checkbox"/> <b>e</b> other reason:
<i>date</i>	<b>10</b>	<input type="checkbox"/> I, requested authority, transmit the following part of the requested information:
<i>date</i>	<b>11</b>	I, requested authority, transmit all (or the final part of) the requested information: <input type="checkbox"/> <b>a</b> Identity confirmed <input type="checkbox"/> <b>b</b> Address confirmed <input type="checkbox"/> <b>c</b> The following data about the identity of the person concerned have changed (or are added): <i>For natural persons:</i> <input type="checkbox"/> First name(s): <input type="checkbox"/> Surname: <input type="checkbox"/> Maiden name: <input type="checkbox"/> Date of birth: <input type="checkbox"/> Place of birth: <i>For legal entities:</i> <input type="checkbox"/> Legal Status: <input type="checkbox"/> Company name: <input type="checkbox"/> <b>d</b> The following address data have changed (or are added): <input type="checkbox"/> Street and nr.: <input type="checkbox"/> Details of address: <input type="checkbox"/> Postcode and town: <input type="checkbox"/> Country: <input type="checkbox"/> Telephone: <input type="checkbox"/> Fax: <input type="checkbox"/> E-mail:

	<input type="checkbox"/> <b>e</b> Financial situation: <input type="checkbox"/> Bank account(s) known : Bank account number (IBAN): ... Bank identification code (BIC): ... Name of the bank: ... <input type="checkbox"/> Employment details: <input type="checkbox"/> Employee — <input type="checkbox"/> Self-employed — <input type="checkbox"/> Unemployed <input type="checkbox"/> It seems that the person concerned has no means to settle the debt/no assets to cover recovery <input type="checkbox"/> The person concerned is bankrupt/insolvent: - Date of order: - Date of release: - Liquidators details: ...Name: ...Street and nr: ...Details of address: ...Postcode and town: ...Country: <input type="checkbox"/> It seems that the person concerned has: <input type="checkbox"/> limited means to partially settle the debt <input type="checkbox"/> sufficient means/assets for recovery <input type="checkbox"/> Comments:
	<input type="checkbox"/> <b>f</b> Debt disputed <input type="checkbox"/> person concerned has been advised to contest the claim in the State of the applicant authority <input type="checkbox"/> references of the dispute, if available: <input type="checkbox"/> further details attached
	<input type="checkbox"/> <b>g</b> Debtor deceased on YYYY/MM/DD <input type="checkbox"/> <b>h</b> Name and address of heirs/will executor: <input type="checkbox"/> <b>i</b> Other comments:
	<input type="checkbox"/> <b>j</b> I recommend proceeding with recovery procedures
	<input type="checkbox"/> <b>k</b> I recommend not proceeding with recovery procedures
<i>date</i>	<b>12</b> <input type="checkbox"/> I, applicant authority, withdraw my request for information.
<i>date</i>	<b>13</b> <input type="checkbox"/> Other: comment from <input type="radio"/> applicant authority or <input type="radio"/> requested authority:

Model form D – request for notification

<b>REQUEST</b>	<b>FOR</b>	<b>NOTIFICATION</b>
<p>Based on Article 23 of the Protocol between the European Union and the United Kingdom on administrative cooperation and combating fraud in the field of Value Added Tax and on mutual assistance for the recovery of claims relating to taxes and duties</p> <p><b>Reference: AA_RA_aaaaaaaaaa_rrrrrrrrrr_20YYMMDD_xxxxxxx_RN</b></p>		

Nature of the claim(s):

<b>1. STATE OF THE APPLICANT AUTHORITY</b>	
<p><b>A. Applicant authority</b></p> <p>Country: Name: Telephone: Reference of the file:</p> <p>Name of the official dealing with the request: Language skills:</p>	<p><b>B. Office initiating the request</b></p> <p>Name: Address: Postcode: Town: Telephone: E-mail: Reference of the file: Name of the official dealing with the request:</p>

<b>2. STATE OF THE REQUESTED AUTHORITY</b>	
<p><b>A. Requested authority</b></p> <p>Country: Name: Telephone: Reference of the file:</p> <p>Name of the official dealing with the request: Language skills:</p>	<p><b>B. Office handling the request</b></p> <p>Name: Address: Postcode: Town: Telephone: E-mail: Reference of the file: Name of the official dealing with the request:</p>

<b>3. INFORMATION RELATING TO THE REQUEST</b>
<p><input type="checkbox"/> Final date for notification of these documents in order to avoid problems with the limitation period (if necessary): 20YY/MM/DD</p>
<p><input type="checkbox"/> Other comments:</p>



<b>4. IDENTIFICATION OF THE ADDRESSEE OF THE NOTIFICATION</b>	
<b>A. The notification should be made to:</b>	
<input type="checkbox"/> <i>For natural persons:</i>	
<u>First name(s):</u>	
<u>Surname:</u>	
Maiden name (name at birth):	
Date of birth:	
Place of birth:	
VAT number:	
Tax Identification Number:	
Other identification data:	
<u>Address of this person:</u> <input type="checkbox"/> <i>known</i> — <input type="checkbox"/> <i>assumed:</i>	
Street and number:	
Details of address:	
Postcode and town:	
Country:	
<input type="checkbox"/> <i>Or for legal entities:</i>	
<u>Company name:</u>	
<u>Legal status:</u>	
VAT number:	
Tax Identification Number:	
Other identification data:	
<u>Address of this legal entity:</u> <input type="checkbox"/> <i>known</i> — <input type="checkbox"/> <i>assumed</i>	
Street and number:	
Details of address:	
Postcode and town:	
Country:	
<input type="checkbox"/> <i>Legal representative</i>	
<u>Name:</u>	
Address of this legal representative: <input type="checkbox"/> <i>known</i> — <input type="checkbox"/> <i>assumed</i>	
Street and number:	
Details of address:	
Postcode and town:	
Country:	
<b>B. Other relevant information concerning the above persons:</b>	

<b>5</b>	<b>PURPOSE OF THE NOTIFICATION: see the attached uniform notification form.</b>
----------	---

<b>6</b>	<b>DESCRIPTION OF THE NOTIFIED DOCUMENT(S): see the attached uniform notification form.</b>
----------	---

<b>7. FOLLOW-UP OF THE REQUEST FOR NOTIFICATION</b>				
<u>Date</u>	<u>Nr</u>	<u>Message</u>	<u>Applicant authority</u>	<u>Requested authority</u>
<i>date</i>	<b>1</b>	<input type="checkbox"/> I, requested authority, acknowledge receipt of the request.		
<i>date</i>	<b>2</b>	<input type="checkbox"/> I, requested authority, invite the applicant authority to complete the request with the following additional information:		
<i>date</i>	<b>3</b>	<input type="checkbox"/> I, requested authority, have not yet received the additional information required and will close your request if I do not receive this information before 20YY/MM/DD.		
<i>date</i>	<b>4</b>	<input type="checkbox"/> I, applicant authority, <input type="checkbox"/> <b>a</b> provide on request the following additional information:  <input type="checkbox"/> <b>b</b> I am not able to provide the requested additional information (because: )		
<i>date</i>	<b>5</b>	<input type="checkbox"/> I, requested authority, acknowledge receipt of the additional information and am now in a position to proceed.		
<i>date</i>	<b>6</b>	<input type="checkbox"/> I, requested authority, do not provide assistance and close the case because: <input type="checkbox"/> <b>a</b> I do not have competence for any of the taxes to which the request relates. <input type="checkbox"/> <b>b</b> the claim(s) is/are older than foreseen in the Protocol. <input type="checkbox"/> <b>c</b> the amount of the claim(s) is below the threshold. <input type="checkbox"/> <b>d</b> the applicant authority did not provide all the required additional information <input type="checkbox"/> <b>e</b> Other reason:		
<i>date</i>	<b>7</b>	<input type="checkbox"/> I, applicant authority, ask to be informed about the present status of my request.		
<i>date</i>	<b>8</b>	<input type="checkbox"/> I, requested authority, certify: <input type="checkbox"/> <b>a</b> that the document(s) has (have) been notified to the addressee, with legal effect according to the national legislation of the State of the requested authority, on date.  The notification was made in the following manner: <input type="checkbox"/> to the addressee in person <input type="checkbox"/> by mail <input type="checkbox"/> by electronic mail <input type="checkbox"/> by registered mail <input type="checkbox"/> by bailiff <input type="checkbox"/> by another procedure <input type="checkbox"/> <b>b</b> that the above-mentioned document(s) could not be notified to the person concerned for the following reasons: <input type="checkbox"/> addressee(s) not known <input type="checkbox"/> addressee(s) deceased <input type="checkbox"/> addressee(s) has (have) left the State. New address: <input type="checkbox"/> other:		

*This document has been agreed between the European Union and the United Kingdom and is provided for information only. No rights may be derived from it until the date of application. The numbering of the articles is provisional.*

<i>date</i>	<b>9</b> <input type="checkbox"/>	I, applicant authority, withdraw my request for notification.
<i>date</i>	<b>10</b> <input type="checkbox"/>	Other: comment from <input type="radio"/> applicant authority or <input type="radio"/> requested authority

Model form E – request for recovery or precautionary measures

<b>REQUEST</b>	<b>FOR</b>	<input type="checkbox"/>	<b>RECOVERY</b>	<b>MEASURES</b>
<p>Based on Article 25 of the Protocol between the European Union and the United Kingdom on administrative cooperation and combating fraud in the field of Value Added Tax and on mutual assistance for the recovery of claims relating to taxes and duties</p>				
<b>AND/OR</b>		<input type="checkbox"/>	<b>PRECAUTIONARY</b>	<b>MEASURES</b>
<p>Based on Article 31 of the Protocol between the European Union and the United Kingdom on administrative cooperation and combating fraud in the field of Value Added Tax and on mutual assistance for the recovery of claims relating to taxes and duties</p>				
<p><b>Reference: AA_RA_aaaaaaaaaa_rrrrrrrrrr_20YYMMDD_xxxxxx_RR(RP)</b></p>				

Nature of the claim(s):

1. STATE OF THE APPLICANT AUTHORITY	
<p><b>A. Applicant authority</b></p> <p><u>Country:</u>  <u>Name:</u>                      Telephone:  <u>Reference of the file:</u></p> <p>Name of the official dealing with the request:                      Language skills:</p>	<p><b>B. Office initiating the request</b></p> <p>Name:                      Address:                      Postcode:                      Town:                      Telephone:                      E-mail:                      Reference of the file:                      Name of the official dealing with the request:</p>

2. STATE OF THE REQUESTED AUTHORITY	
<p><b>A. Requested authority</b></p> <p><u>Country:</u>  <u>Name:</u>                      Telephone:  <u>Reference of the file:</u></p> <p>Name of the official dealing with the request:                      Language skills:</p>	<p><b>B. Office handling the request</b></p> <p>Name:                      Address:                      Postcode:                      Town:                      Telephone:                      E-mail:                      Reference of the file:                      Name of the official dealing with the request:</p>

### 3. INFORMATION ABOUT THE REQUEST

- The claim(s) is (are) the subject of an instrument permitting enforcement in the applicant State.
- The claim(s) is (are) not yet subject of an instrument permitting enforcement in the applicant State.
- The claim(s) is (are) not contested.
- The claim(s) may no longer be contested by an administrative appeal/by an appeal to the courts.
- The claim(s) is (are) contested but the laws, regulations and administrative practices in force in the State of the applicant authority allow recovery of a contested claim.

- The total amount of the claims for which assistance is requested, is not less than GBP 5,000.
- This request relates to claims that fulfil the age requirement applying under the Protocol.

- This request for precautionary measures is based on the reasons described in the attached document(s).
- This request is accompanied by an instrument permitting precautionary measures in the applicant state.
- I request not to inform the debtor/other person concerned prior to the precautionary measures.

- Please contact me if the following specific situation occurs (by using the free text field at the end of the request form :

- I, applicant authority will reimburse the sums already transferred if the outcome of the contestation is favorable to the party concerned.

- Sensitive case:*

### 4. PAYMENT INSTRUCTIONS

#### A. Please remit the amount of the claim recovered to:

- Bank account number (IBAN):
- Bank identification code (BIC):
- Name of the bank:
- Name of the account holder:
- Address of the account holder:
- Payment reference to be used at the transfer of the money:

#### B. *Payment by instalment is:*

- acceptable without further consultation
- only acceptable after consultation (*Please use box 7, point 20 for this consultation*)
- not acceptable

**5. INFORMATION ABOUT THE PERSON CONCERNED BY THE REQUEST**

A	<p>Recovery/precautionary measures are requested with regard to:</p> <p><input type="checkbox"/> <i>For natural persons:</i> <u>First name(s):</u> <u>Surname:</u> Maiden name (name at birth): Date of birth: Place of birth: VAT number: Tax Identification Number: Other identification data: Address of this person/legal entity: <input type="checkbox"/> <i>known</i> — <input type="checkbox"/> <i>assumed</i> Street and number: Details of address: Postcode and town:</p> <p><input type="checkbox"/> <i>Or for legal entities:</i> <u>Legal status:</u> <u>Company name:</u> VAT number: Tax Identification Number: Other identification data: Address of this person/legal entity: <input type="checkbox"/> <i>known</i> — <input type="checkbox"/> <i>assumed</i> Street and number: Details of address: Postcode and town:</p> <p>- other information concerning this person:</p> <p>- <input type="checkbox"/> Legal representative <u>Name:</u> Details of address: <input type="checkbox"/> <i>known</i> — <input type="checkbox"/> <i>assumed</i> Street and number: Postcode and town: Country:</p>
B	Other relevant information concerning this request and/or person

<p>1</p> <input type="checkbox"/>	<p>The following person(s) is (are) co-debtor(s): <i>[It should be possible to add more than 1 name of such persons]</i></p> <p>- Identity of this person :</p> <p><input type="checkbox"/> <i>For natural persons:</i>  <u>Name:</u>  Date of birth:  VAT number:  Tax Identification Number:  Street and number:  Details of address:  Postcode and town:</p> <p><input type="checkbox"/> <i>Or for legal entities:</i>  <u>Legal status:</u>  <u>Company name:</u>  VAT number:  Tax Identification Number:  Street and number:  Details of address:  Postcode and town:</p> <p>- other information concerning this (these) co-debtor(s):</p>
<p>2</p> <input type="checkbox"/>	<p>The following person(s) is (are) holding assets belonging to the person concerned by this request: <i>[It should be possible to add more than 1 name of such persons]</i></p> <p>- Identity of this person :</p> <p><input type="checkbox"/> <i>For natural persons:</i>  <u>Name:</u>  Date of birth:  VAT number:  Tax Identification Number:  Street and number:  Details of address:  Postcode and town:</p> <p><input type="checkbox"/> <i>Or for legal entities:</i>  <u>Legal status:</u>  <u>Company name:</u>  VAT number:  Tax Identification Number:  Street and number:  Details of address:  Postcode and town:</p> <p>- assets held by this other person:</p>

3 <input type="checkbox"/>	<p>The following person(s) is (are) having debts towards the person concerned by this request: <i>[It should be possible to add more than 1 name of such persons]</i></p> <p>- Identity of this person:</p> <p><input type="checkbox"/> <i>For natural persons:</i>  <u>Name:</u>  Date of birth:  VAT number:  Tax Identification Number:  Street and number:  Details of address:  Postcode and town:</p> <p><input type="checkbox"/> <i>Or for legal entities:</i>  <u>Legal status:</u>  <u>Company name:</u>  VAT number  Tax Identification Number:  Street and number:  Details of address:  Postcode and town:</p> <p>- (future) debts of this other person:</p>
4 <input type="checkbox"/>	<p>There (is) are (an)other person(s) than the person concerned by this request, who (is) are liable for settlement of the taxes, duties and other measures, or for other claims relating to these taxes, duties and other measures under the laws of the applicant State. <i>[It should be possible to add more than 1 name of such persons]</i></p> <p>- Identity of this person :</p> <p><input type="checkbox"/> <i>For natural persons:</i>  <u>Name:</u>  Date of birth:  VAT number:  Tax Identification Number:  Street and number:  Details of address:  Postcode and town:</p> <p><input type="checkbox"/> <i>Or for legal entities:</i>  <u>Legal status:</u>  <u>Company name:</u>  VAT number:  Tax Identification Number:  Street and number:  Details of address:  Postcode and town:</p> <p>- Reason or nature of the liability of this other person:</p>

**6. DESCRIPTION OF THE CLAIM(S):** see the attached uniform instrument permitting enforcement in the requested State.



7. FOLLOW-UP OF THE REQUEST	Applicant authority	Requested authority
<i>date</i>	<b>1</b> <input type="checkbox"/> I, requested authority, acknowledge receipt of the request..	
<i>date</i> <input type="checkbox"/> To be combined with acknowledgment	<b>2</b> <input type="checkbox"/> I, requested authority, invite the applicant authority to complete the request with the following additional information:	
<i>date</i>	<b>3</b> <input type="checkbox"/> I, requested authority, have not yet received the additional information required and will close your request if I do not receive this information before 20YY/MM/DD.	
<i>date</i>	<b>4</b> I, applicant authority, <input type="checkbox"/> <b>a</b> provide on request the following additional information: <input type="checkbox"/> <b>b</b> am not able to provide the requested additional information (because: _____)	
<i>date</i>	<b>5</b> <input type="checkbox"/> I, requested authority, acknowledge receipt of the additional information and am now in a position to proceed.	
<i>date</i>	<b>6</b> I, requested authority, do not provide assistance and close the case because: <input type="checkbox"/> <b>a</b> I do not have competence for the claims to which your request relates. <input type="checkbox"/> <b>b</b> I do not have competence for the following claim(s) of your request: <b>c</b> the claim(s) is/are older than foreseen in the Protocol. <input type="checkbox"/> <b>d</b> the total amount is less than the threshold foreseen in the Protocol. <input type="checkbox"/> <b>e</b> the applicant authority did not provide all the required additional information. <input type="checkbox"/> <b>f</b> Other reason: <input type="checkbox"/>	
<i>date</i>	<b>7</b> <input type="checkbox"/> I, applicant authority, ask to be informed about the present status of my request.	
<i>date</i>	<b>8</b> I, requested authority, will not take the requested action(s), for the following reasons: <input type="checkbox"/> <b>a</b> my national legislation and practice does not allow recovery measures for claims that are contested. <input type="checkbox"/> <b>b</b> my national legislation and practice does not allow precautionary measures for claims that are contested.	
<i>date</i> <i>date</i> <i>date</i>	<b>9</b> I, requested authority, have conducted the following procedures for recovery and/or precautionary measures: <input type="checkbox"/> <b>a</b> I established contact with the debtor and requested payment on 20YY/MM/DD. <input type="checkbox"/> <b>b</b> I am negotiating payment by instalment. <input type="checkbox"/> <b>c</b> I have commenced enforcement procedures on 20YY/MM/DD. The following actions have been taken: <input type="checkbox"/> <b>d</b> I have commenced precautionary measures on 20YY/MM/DD. The following actions have been taken: <input type="checkbox"/> <b>e</b> I, requested authority, inform the applicant authority that the measures which I have taken (described under point c and/or d above) have the following effect on the period of limitation: <input type="checkbox"/> suspension <input type="checkbox"/> interruption <input type="checkbox"/> prolongation <input type="checkbox"/> till 20YY/MM/DD – <input type="checkbox"/> with <b>xx years/months/weeks/days</b> I ask the applicant State to inform me if the same effect is not provided for under the laws in force in the applicant State. <input type="checkbox"/> <b>f</b> I, requested authority, inform the applicant authority that suspension, interruption or prolongation of the period of limitation is not possible under the laws of the requested State. I ask the applicant State to confirm whether the measures which I have taken (described under point c and/or d above) have interrupted, suspended or prolonged the time limit for recovery and, if so, what the new time limit is.	

date	<b>10</b> <input type="checkbox"/> Procedures are still going on. I, requested authority, will inform applicant authority when changes occur.
date	<b>11</b> <input type="checkbox"/> a I, applicant authority, confirm that: as a result of the action mentioned under point 9, the time limit has been changed. The new time limit is : ... <input type="checkbox"/> b My national laws do not provide for the suspension, interruption or prolongation of the period of limitation.
date	<b>12</b> I, requested authority, inform the applicant authority that: <input type="checkbox"/> a the claim has been fully recovered on 20YY/MM/DD - of which the following amount ( <i>indicate the currency of the State of the requested authority</i> ) relates to the claim as mentioned in the request: - of which the following amount relates to the interest charged under the laws of the State of the requested authority: date <input type="checkbox"/> b the claim has been partly recovered on 20YY/MM/DD, - for the amount of ( <i>indicate the currency of the State of the requested authority</i> ): - of which the following amount relates to the claim as mentioned in the request:  - of which the following amount relates to the interest charged under the laws of the State of the requested authority: <input type="checkbox"/> I will take no further action. <input type="checkbox"/> I will continue recovery procedures. date <input type="checkbox"/> c precautionary measures have been taken. ( <i>The requested authority is invited to indicate the nature of these measures:           </i> ) date <input type="checkbox"/> d the following payment by instalment has been agreed:
date	<b>13</b> I, requested authority, confirm that all or part of the claim could not be recovered/ precautionary measures will not be taken, and the case will be closed because: <input type="checkbox"/> a The person concerned is not known. <input type="checkbox"/> b The person concerned is known, but moved to: <input type="checkbox"/> c The person concerned is known, but moved to an unknown address. <input type="checkbox"/> d The person concerned is deceased on YYYY/MM/DD. <input type="checkbox"/> e Debtor/co-debtor is insolvent. <input type="checkbox"/> f Debtor/co-debtor is bankrupt and the claim has been lodged. Date of order:        --- Date of release: <input type="checkbox"/> g Debtor/co-debtor is bankrupt / no recovery possible <input type="checkbox"/> h Others:
date	<b>14</b> <input type="checkbox"/> I, applicant authority, confirm that the case is closed.
date	<b>15</b> I, requested authority, inform the applicant authority that I have received notification that <input type="checkbox"/> an action has been launched contesting the claim or the instrument permitting its enforcement and will suspend enforcement procedures. Further, <input type="checkbox"/> a I have taken precautionary measures to ensure recovery of the claim on            . <input type="checkbox"/> b I ask the applicant authority to inform me whether I should recover the claim. <input type="checkbox"/> c I inform the applicant authority that the laws, regulations and administrative practices in force in the State in which I am situated do not permit (continued) recovery of the claim as long as it is contested.
date	<b>16</b> I, applicant authority, having been informed that an action has been launched contesting the claim or the instrument permitting its enforcement, <input type="checkbox"/> a ask the requested authority to suspend any action which it has undertaken. <input type="checkbox"/> b ask the requested authority to take precautionary measures to ensure recovery of the claim. <input type="checkbox"/> c ask the requested authority to (continue to) recover the claim.

<i>date</i>	<p><b>17</b> I, requested authority, inform the applicant authority that the laws, regulations and administrative practices in force in the State in which I am situated do not permit the action requested:</p> <p><input type="checkbox"/> under point 16(b).</p> <p><input type="checkbox"/> under point 16(c).</p>
<i>date</i>	<p><b>18</b> I, applicant authority,</p> <p><input type="checkbox"/> <b>a</b> amend the request for recovery/precautionary measures</p> <p style="margin-left: 20px;"><input type="checkbox"/> in accordance with the decision about the contested claim, [this information about the decision will be put in box 6A]</p> <p style="margin-left: 20px;"><input type="checkbox"/> because part of the claim was paid directly to the applicant authority;</p> <p style="margin-left: 20px;"><input type="checkbox"/> for another reason: .</p> <p><input type="checkbox"/> <b>b</b> ask the requested authority to resume enforcement procedures since the contestation was not favourable to the debtor (decision of the body competent in this matter of ).</p>
<i>date</i>	<p><b>19</b> I, applicant authority, withdraw this request for recovery/precautionary measures because:</p> <p><input type="checkbox"/> <b>a</b> the amount was paid directly to the applicant authority.</p> <p><input type="checkbox"/> <b>b</b> the time limit for recovery action has elapsed.</p> <p><input type="checkbox"/> <b>c</b> the claim(s) has (have) been annulled by a national court or by an administrative body.</p> <p><input type="checkbox"/> <b>d</b> the instrument permitting enforcement has been annulled.</p> <p><input type="checkbox"/> <b>e</b> other reason:</p>
<i>date</i>	<p><b>20</b> Other:comment from <input type="radio"/> applicant authority or <input type="radio"/> requested authority</p> <p><input type="checkbox"/> <i>(Please start each comment by indicating the date)</i></p>

## PROTOCOL ON MUTUAL ADMINISTRATIVE ASSISTANCE IN CUSTOMS MATTERS

### Article 1: Definitions

1. For the purposes of this Protocol:
  - (a) “applicant authority” means a competent administrative authority which has been designated by a Party for this purpose and which makes a request for assistance on the basis of this Protocol;
  - (b) “operations in breach of customs legislation” means any violation or attempted violation of customs legislation;
  - (c) “requested authority” means a competent administrative authority which has been designated by a Party for this purpose and which receives a request for assistance on the basis of this Protocol.
2. Unless otherwise provided in this Protocol, the definitions of Chapter 5 [Customs and Trade Facilitation] of Title I [Trade in Goods] of Heading One [Trade] of Part Two [Trade, transport and fisheries] of this Agreement also apply to this Protocol.

### Article 2: Scope

1. The Parties shall assist each other in the areas within their competence, in the manner and under the conditions laid down in this Protocol, to ensure the correct application of customs legislation, in particular by preventing, investigating and combating operations in breach of that legislation.
2. The provisions on assistance in customs matters provided for in this Protocol apply to any administrative authority of either Party which is competent for the application of this Protocol. That assistance shall neither prejudice the provisions governing mutual assistance in criminal matters nor shall it cover information obtained under powers exercised at the request of a judicial authority, except where communication of such information is authorised by that authority.
3. Assistance in the recovery of duties, taxes or fines is covered by the Protocol on administrative cooperation and combating fraud in the field of Value Added Tax and on mutual assistance for the recovery of claims relating to taxes and duties.

### Article 3: Assistance on request

1. At the request of the applicant authority, the requested authority shall provide the applicant authority with all relevant information which may enable the applicant authority to ensure that customs legislation is correctly applied, including information related to activities noted or planned which are or could be operations in breach of customs legislation.
2. At the request of the applicant authority, the requested authority shall in particular inform it whether:
  - (a) goods exported from the territory of one of the Parties have been properly imported into the territory of the other Party, specifying, where appropriate, the customs procedure applied to the goods;

- (b) goods imported into the territory of one of the Parties have been properly exported from the territory of the other Party, specifying, where appropriate, the customs procedure applied to the goods.

3. At the request of the applicant authority, the requested authority shall take the necessary steps in accordance with its applicable laws and regulations to ensure special surveillance of and to provide the applicant authority with information on:

- (a) natural or legal persons in respect of whom there are reasonable grounds for believing that they are or have been involved in operations in breach of customs legislation;
- (b) goods that are or may be transported in such a way that there are reasonable grounds for believing that they have been or are intended to be used in operations in breach of customs legislation;
- (c) places where stocks of goods have been or may be stored or assembled in such a way that there are reasonable grounds for believing that these goods have been or are intended to be used in operations in breach of customs legislation;
- (d) means of transport that are or may be used in such a way that there are reasonable grounds for believing that they are intended to be used in operations in breach of customs legislation.; and
- (e) premises suspected by the applicant authority of being used to commit breaches of customs legislation.

#### Article 4: Spontaneous assistance

Wherever possible, on their own initiative, the Parties shall assist each other in accordance with their laws and regulations by providing information on concluded, planned or ongoing activities which constitute or appear to constitute operations in breach of customs legislation and which may be of interest to the other Party. The information shall focus in particular on:

- (a) goods known to be subject to operations in breach of customs legislation;
- (b) persons in respect of whom there are reasonable grounds for believing they are or have been involved in operations in breach of customs legislation;
- (c) means of transport in respect of which there are reasonable grounds for believing that they have been, are, or may be used in operations in breach of customs legislation; and
- (d) new means or methods employed in carrying out operations in breach of customs legislation.

#### Article 5: Form and substance of requests for assistance

1. Requests pursuant to this Protocol shall be made in writing either in print or electronic format. They shall be accompanied by the documents necessary to enable compliance with the request. In case of urgency, the requested authority may accept oral requests, but such oral requests shall be confirmed by the applicant authority in writing promptly.

2. Requests pursuant to paragraph 1 shall include the following information:

- (a) the applicant authority and requesting official;

- (b) the information and/or type of assistance requested;
- (c) the object of and the reason for the request;
- (d) the laws and regulations and other legal elements involved;
- (e) indications as exact and comprehensive as possible on the goods or persons who are the target of the investigations;
- (f) a summary of the relevant facts and of the enquiries already carried out; and
- (g) any additional available details to enable the requested authority to comply with the request.

3. Requests shall be submitted in an official language of the requested authority or in a language acceptable to that authority, English always being an acceptable language. This requirement does not apply to any documents that accompany the request under paragraph 1.

4. If a request does not meet the formal requirements set out in paragraphs 1 to 3, the requested authority may require the correction or the completion of the request; pending such correction or completion, precautionary measures may be ordered.

#### Article 6: Execution of requests

1. In order to comply with a request for assistance, the requested authority shall proceed promptly, within the limits of its competence, as though it was acting on its own account or at the request of another authority of that same Party, by supplying information already in its possession, by carrying out appropriate enquiries or by arranging for those enquiries to be carried out. This provision shall also apply to any other authority to which the request has been addressed by the requested authority when the latter cannot act on its own. In providing any such assistance the requested authority shall give appropriate consideration to the urgency of the request.

2. Requests for assistance shall be executed in accordance with the laws and regulations of the requested Party.

#### Article 7: Form in which information is to be communicated

1. The requested authority shall communicate results of enquiries conducted pursuant to a request made under this Protocol to the applicant authority in writing, together with relevant documents, certified copies of documents or other items. This information may be provided in electronic format.

2. Original documents shall be transmitted according to each Party's legal constraints, only at the request of the applicant authority, in cases where certified copies would be insufficient. The applicant authority shall return those originals at the earliest opportunity.

3. Under the provisions referred to in paragraph 2, the requested authority shall deliver to the applicant authority any information related to the authenticity of the documents issued or certified by official agencies within its territory in support of a goods declaration.

#### Article 8: Presence of officials of one Party in the territory of another

1. Duly authorised officials of a Party may, with the agreement of the other Party and subject to the conditions laid down by the latter, be present in the offices of the requested authority or any

other concerned authority referred to in paragraph 1 of Article 6 [Execution of requests] to obtain information relating to activities that are or could be operations in breach of customs legislation which the applicant authority needs for the purposes of this Protocol.

2. With the agreement of the requested Party, and subject to the conditions it may specify, duly authorised officials of the other Party may be present at enquiries carried out in the requested Party's territory.

#### Article 9: Delivery and notification

1. At the request of the applicant authority, the requested authority shall take all necessary measures in accordance with its applicable laws and regulations in order to deliver any documents or to notify any decisions of the applicant authority that fall within the scope of this Protocol, to an addressee residing or established in the territory of the requested authority.

2. Such requests for the delivery of documents or the notification of decisions shall be made in writing in an official language of the requested authority or in a language acceptable to that authority.

#### Article 10: Automatic exchange of information

1. The Parties may, by mutual arrangement in accordance with Article 15 of this Protocol [Implementation]:

- (a) exchange any information covered by this Protocol on an automatic basis;
- (b) exchange specific information in advance of the arrival of consignments in the territory of the other Party.

2. The Parties may establish arrangements on the type of information they wish to exchange, the format and the frequency of transmission to implement the exchanges under points (a) and (b) of paragraph 1.

#### Article 11: Exceptions to the obligation to provide assistance

1. Assistance under this Protocol may be refused or may be subject to the satisfaction of certain conditions or requirements in cases where a Party is of the opinion that such assistance would:

- (a) be likely to prejudice the sovereignty of the United Kingdom or that of a Member State which has been requested to provide assistance under this Protocol;
- (b) be likely to prejudice public policy, security or other essential interests; or
- (c) violate an industrial, commercial or professional secret.

2. The requested authority may postpone the assistance on the grounds that such assistance will interfere with ongoing investigations, prosecutions or proceedings. In such a case, the requested authority shall consult with the applicant authority to determine if assistance can be given subject to such terms or conditions as the requested authority may require.

3. Where the applicant authority seeks assistance which it would itself be unable to provide if so requested, it shall draw attention to that fact in its request. It shall then be for the requested authority to decide how to respond to such a request.

4. In the cases referred to in paragraphs 1 and 2, the requested authority shall communicate its decision and the reasons for that decision to the applicant authority without delay.

#### Article 12: Information exchange and confidentiality

1. The information received under this Protocol shall be used solely for the purposes established in this Protocol.

2. The use of information obtained under this Protocol in administrative or judicial proceedings instituted in respect of operations in breach of customs legislation is considered to be for the purposes of this Protocol. Therefore, the Parties may use information obtained and documents consulted in accordance with the provisions of this Protocol as evidence in their records of evidence, reports and testimonies and in proceedings and charges brought before the courts or tribunals. The requested authority may subject the supply of information or the granting of access to documents to the condition that it is notified of such use.

3. Where one of the Parties wishes to use such information for other purposes, it shall obtain the prior written consent of the authority which provided the information. Such use shall then be subject to any restrictions laid down by that authority.

4. Any information communicated in whatsoever form pursuant to this Protocol shall be considered to be of a confidential or restricted nature, in accordance with the laws and regulations applicable in each Party. That information shall be covered by the obligation of professional secrecy and shall enjoy the protection granted to similar information under the relevant laws and regulations of the receiving Party, unless the Party which provided the information gives its prior consent to the disclosure of such information. The Parties shall communicate to each other information on their applicable laws and regulations.

#### Article 13: Experts and witnesses

The requested authority may authorise its officials to appear, within the limitations of the authorisation granted, as experts or witnesses in judicial or administrative proceedings regarding the matters covered by this Protocol, and produce such objects, documents or confidential or certified copies thereof, as may be needed for the proceedings. The request for appearance must indicate specifically before which judicial or administrative authority the official will have to appear, on what matters and by virtue of what title or qualification the official will be questioned.

#### Article 14: Assistance expenses

1. Subject to paragraphs 2 and 3, the Parties shall waive any claims on each other for reimbursements of expenses incurred in the execution of this Protocol.

2. Expenses and allowances paid to experts, witnesses, interpreters and translators, other than public service employees, shall be borne as appropriate by the requesting Party.

3. If expenses of a substantial or extraordinary nature are or will be required to execute the request, the Parties shall consult to determine the terms and conditions under which the request is to be executed, as well as the manner in which the costs are to be borne.



#### Article 15: Implementation

1. The implementation of this Protocol shall be entrusted on the one hand to the customs authorities of the United Kingdom and on the other hand to the competent services of the European Commission and the customs authorities of the Member States of the Union, as appropriate. They shall decide on all practical measures and arrangements necessary for the implementation of this Protocol, taking into consideration their respective applicable laws and regulations, in particular for the protection of personal data.
2. Each Party shall keep the other Party informed of the detailed implementation measures which it adopts in accordance with the provisions of this Protocol, in particular with respect to the duly authorised services and officials designated as competent to send and receive the communications provided for in this Protocol.
3. In the Union, the provisions of this Protocol shall not affect the communication of any information obtained under this Protocol between the competent services of the European Commission and the customs authorities of the Member States.

#### Article 16: Other agreements

The provisions of this Protocol shall take precedence over the provisions of any bilateral agreement on mutual administrative assistance in customs matters which has been or may be concluded between individual Member States of the Union and the United Kingdom insofar as the provisions of those bilateral agreements are incompatible with those of this Protocol.

#### Article 17: Consultations

In respect of the interpretation and implementation of this Protocol, the Parties shall consult each other to resolve the matter in the framework of the [Trade Specialised Committee on customs cooperation and rules of origin].

#### Article 18: Future developments

With a view to supplementing the levels of mutual assistance provided for in this Protocol, the Trade Specialised Committee on customs cooperation and rules of origin may adopt a decision to expand this Protocol by establishing arrangements on specific sectors or matters in accordance with the Parties' respective customs legislation.

## PROTOCOL ON SOCIAL SECURITY COORDINATION

### TITLE I: GENERAL PROVISIONS

#### Article SSC.1: Definitions

For the purposes of this Protocol, the following definitions apply:

- (a) "activity as an employed person" means any activity or equivalent situation treated as such for the purposes of the social security legislation of the State in which such activity or equivalent situation exists;
- (b) "activity as a self-employed person" means any activity or equivalent situation treated as such for the purposes of the social security legislation of the State in which such activity or equivalent situation exists;
- (c) "assisted conception services" means any medical, surgical or obstetric services provided for the purpose of assisting a person to carry a child;
- (d) "benefits in kind" means:
  - (i) for the purposes of Chapter 1 [Sickness, maternity and equivalent paternity benefits] of Title III, benefits in kind provided for under the legislation of a State which are intended to supply, make available, pay directly or reimburse the cost of medical care and products and services ancillary to that care;
  - (ii) for the purposes of Chapter 2 [Accidents at work and occupational diseases] of Title III, all benefits in kind relating to accidents at work and occupational diseases as defined in point (i) and provided for under the States' accidents at work and occupational diseases schemes;
- (e) "child-raising period" refers to any period which is credited under the pension legislation of a State or which provides a supplement to a pension explicitly for the reason that a person has raised a child, irrespective of the method used to calculate those periods and whether they accrue during the time of child-raising or are acknowledged retroactively;
- (f) "civil servant" means a person considered to be such or treated as such by the State to which the administration employing them is subject;
- (g) "competent authority" means, in respect of each State, the Minister, Ministers or other equivalent authority responsible for social security schemes throughout or in any part of the State in question;
- (h) "competent institution" means:
  - (i) the institution with which the person concerned is insured at the time of the application for benefit; or
  - (ii) the institution from which the person concerned is or would be entitled to benefits if that person or a member or members of their family resided in the State in which the institution is situated; or

- (iii) the institution designated by the competent authority of the State concerned; or
  - (iv) in the case of a scheme relating to an employer's obligations in respect of the benefits set out in Article SSC.3(1) [Matters covered], either the employer or the insurer involved or, in default thereof, the body or authority designated by the competent authority of the State concerned;
- (i) "competent State" means the State in which the competent institution is situated;
  - (j) "death grant" means any one-off payment in the event of death, excluding the lump-sum benefits referred to in point (w);
  - (k) "family benefit" means all benefits in kind or in cash intended to meet family expenses;
  - (l) "frontier worker" means any person pursuing an activity as an employed or self-employed person in a State and who resides in another State to which that person returns as a rule daily or at least once a week;
  - (m) "home base" means the place from where the crew member normally starts and ends a duty period or a series of duty periods, and where, under normal conditions, the operator/airline is not responsible for the accommodation of the crew member concerned;
  - (n) "institution" means, in respect of each State, the body or authority responsible for applying all or part of the legislation;
  - (o) "institution of the place of residence" and "institution of the place of stay" mean, respectively, the institution which is competent to provide benefits in the place where the person concerned resides and the institution which is competent to provide benefits in the place where the person concerned is staying, in accordance with the legislation administered by that institution or, where no such institution exists, the institution designated by the competent authority of the State concerned;
  - (p) "insured person", in relation to the social security branches covered by Chapters 1 [Sickness, maternity and equivalent paternity benefits] and 3 [Death grants] of Title III [Special provisions concerning the various categories of benefits], means any person satisfying the conditions required under the legislation of the State competent under Title II [Determination of the legislation applicable] in order to have the right to benefits, taking into account the provisions of this Protocol;
  - (q) "legislation" means, in respect of each State, laws, regulations and other statutory provisions and all other implementing measures relating to the social security branches covered by Article SSC.3(1) [Matters covered], but excludes contractual provisions other than those which serve to implement an insurance obligation arising from the laws and regulations referred to in this point or which have been the subject of a decision by the public authorities which makes them obligatory or extends their scope, provided that the State concerned makes a declaration to that effect, notified to the Specialised Committee on Social Security Coordination. The European Union shall publish such a declaration in the Official Journal of the European Union;
  - (r) "long-term care benefit" means a benefit in kind or in cash the purpose of which is to address the care needs of a person who, on account of impairment, requires considerable assistance, including but not limited to assistance from another person or persons to carry out essential activities of daily living for an extended period of time in order to support their personal

autonomy; this includes benefits granted for the same purpose to a person providing such assistance;

- (s) "member of the family" means:
- (i) (A) any person defined or recognised as a member of the family or designated as a member of the household by the legislation under which benefits are provided;  
  
(B) with regard to benefits in kind pursuant to Title III [Special provisions concerning the various categories of benefits], Chapter 1 [Sickness, maternity and equivalent paternity benefits], any person defined or recognised as a member of the family or designated as a member of the household by the legislation of the State in which that person resides;
  - (ii) if the legislation of a State which is applicable under subparagraph 1 does not make a distinction between the members of the family and other persons to whom it is applicable, the spouse, minor children, and dependent children who have reached the age of majority shall be considered members of the family;
  - (iii) if, under the legislation which is applicable under subparagraphs (1) and (2), a person is considered a member of the family or member of the household only if that person lives in the same household as the insured person or pensioner, this condition shall be considered satisfied if the person in question is mainly dependent on the insured person or pensioner;
- (t) "period of employment" or "period of self-employment" mean periods so defined or recognised by the legislation under which they were completed, and all periods treated as such, where they are regarded by that legislation as equivalent to periods of employment or to periods of self-employment;
- (u) "period of insurance" means periods of contribution, employment or self-employment as defined or recognised as periods of insurance by the legislation under which they were completed or considered as completed, and all periods treated as such, where they are regarded by that legislation as equivalent to periods of insurance;
- (v) "period of residence" means periods so defined or recognised by the legislation under which they were completed or considered as completed;
- (w) "pension" covers not only pensions but also lump-sum benefits which can be substituted for them and payments in the form of reimbursement of contributions and, subject to the provisions of Title III [Special provisions concerning the various categories of benefits], revaluation increases or supplementary allowances;
- (x) "pre-retirement benefit" means all cash benefits, other than an unemployment benefit or an early old-age benefit, provided from a specified age to workers who have reduced, ceased or suspended their remunerative activities until the age at which they qualify for an old-age pension or an early retirement pension, the receipt of which is not conditional upon the person concerned being available to the employment services of the competent State; "early old-age benefit" means a benefit provided before the normal pension entitlement age is reached and which either continues to be provided once the said age is reached or is replaced by another old-age benefit;

- (y) "refugee" has the meaning assigned to it in Article 1 of the Convention relating to the Status of Refugees, signed in Geneva on 28 July 1951;
- (z) "registered office or place of business" means the registered office or place of business where the essential decisions of the undertaking are adopted and where the functions of its central administration are carried out;
- (aa) "residence" means the place where a person habitually resides;
- (bb) "special non-contributory cash benefits" means those non-contributory cash benefits which:
  - (i) are intended to provide either:
    - (A) supplementary, substitute or ancillary cover against the risks covered by the branches of social security referred to in Article SSC.3(1) [Matters covered], and which guarantee the persons concerned a minimum subsistence income having regard to the economic and social situation in the State concerned; or
    - (B) solely specific protection for the disabled, closely linked to the said person's social environment in the State concerned, and
  - (ii) where the financing exclusively derives from compulsory taxation intended to cover general public expenditure and the conditions for providing and for calculating the benefits are not dependent on any contribution in respect of the beneficiary. However, benefits provided to supplement a contributory benefit shall not be considered to be contributory benefits for this reason alone;
- (cc) "special scheme for civil servants" means any social security scheme which is different from the general social security scheme applicable to employed persons in the State concerned and to which all, or certain categories of, civil servants are directly subject;
- (dd) "stateless person" has the meaning assigned to it in Article 1 of the Convention relating to the Status of Stateless Persons, signed in New York on 28 September 1954;
- (ee) "stay" means temporary residence.

#### Article SSC.2: Persons covered

This Protocol shall apply to persons, including stateless persons and refugees, who are or have been subject to the legislation of one or more States, as well as to the members of their families and their survivors.

#### Article SSC.3: Matters covered

1. This Protocol shall apply to the following branches of social security:
  - (a) sickness benefits;
  - (b) maternity and equivalent paternity benefits;
  - (c) invalidity benefits;
  - (d) old-age benefits;

- (e) survivors' benefits;
- (f) benefits in respect of accidents at work and occupational diseases;
- (g) death grants;
- (h) unemployment benefits;
- (i) pre-retirement benefits.

2. Unless otherwise provided for in Annex SSC-6 [Special provisions for the application of the legislation of the Member States and of the United Kingdom], this Protocol shall apply to general and special social security schemes, whether contributory or non-contributory, and to schemes relating to the obligations of an employer or ship-owner.

3. The provisions of Title III [Special provisions concerning the various categories of benefits] shall not, however, affect the legislative provisions of any State concerning a ship-owner's obligations.

4. This Protocol shall not apply to:

- (a) special non-contributory cash benefits listed in Part 1 [Special non-contributory cash benefits] of Annex SSC-1 [Certain benefits in cash to which the Protocol shall not apply];
- (b) social and medical assistance;
- (c) benefits in relation to which a State assumes the liability for damages to persons and provides for compensation, such as those for victims of war and military action or their consequences; victims of crime, assassination or terrorist acts; victims of damage occasioned by agents of the State in the course of their duties; or victims who have suffered a disadvantage for political or religious reasons or for reasons of descent;
- (d) long-term care benefits which are listed in Part 2 [Long-term care benefits] of Annex SSC-1 [Certain benefits in cash to which this Protocol shall not apply];
- (e) assisted conception services;
- (f) payments which are connected to a branch of social security listed in paragraph (1) and which are:
  - (i) paid to meet expenses for heating in cold weather; and
  - (ii) listed in Part 3 [Payments which are connected to a branch of social security listed in Article SSC.3(1) [Matters covered] and which are paid to meet expenses for heating in cold weather (point (f) of Article SSC.3(4) [Matters covered]] of Annex SSC-1 [Certain benefits in cash to which this Protocol shall not apply];
- (g) family benefits.

#### Article SSC.4: Non-discrimination between Member States

1. Social security coordination arrangements established in this Protocol shall be based on the principle of non-discrimination between the Member States of the Union.

2. This article is without prejudice to any arrangements made between the United Kingdom and Ireland concerning the Common Travel Area.

#### Article SSC.5: Equality of treatment

1. Unless otherwise provided for in this Protocol, as regards the branches of social security covered by Article SSC.3(1) [Matters covered], persons to whom this Protocol applies shall enjoy the same benefits and be subject to the same obligations under the legislation of any State as the nationals thereof.

2. This provision does not apply to the matters referred to in Article SSC.3(4) [Matters covered].

#### Article SSC.6 : Equal treatment of benefits, income, facts or events

Unless otherwise provided for in this Protocol, the States shall ensure the application of the principle of equal treatment of benefits, income, facts or events in the following manner:

- (a) where, under the legislation of the competent State, the receipt of social security benefits and other income has certain legal effects, the relevant provisions of that legislation shall also apply to the receipt of equivalent benefits acquired under the legislation of another State or to income acquired in another State;
- (b) where, under the legislation of the competent State, legal effects are attributed to the occurrence of certain facts or events, that State shall take account of like facts or events that have occurred in any other State as though they had taken place in its own territory.

#### Article SSC.7: Aggregation of periods

Unless otherwise provided for in this Protocol, the competent institution of a State shall, to the extent necessary, take into account periods of insurance, employment, self-employment or residence completed under the legislation of any other State as though they were periods completed under the legislation which it applies, where its legislation makes conditional upon the completion of periods of insurance, employment, self-employment or residence:

- (a) the acquisition, retention, duration or recovery of the right to benefits;
- (b) the coverage by legislation; or
- (c) the access to or the exemption from compulsory, optional continued or voluntary insurance.

#### Article SSC.8: Waiving of residence rules

The States shall ensure the application of the principle of exportability of cash benefits in accordance with paragraphs (a) and (b):

- (a) Cash benefits payable under the legislation of a State or under this Protocol shall not be subject to any reduction, amendment, suspension, withdrawal or confiscation on account of the fact that the beneficiary or the members of their family reside in a State other than that in which the institution responsible for providing benefits is situated.
- (b) Point (a) does not apply to the cash benefits covered by points (c) and (h) of Article SSC.3(1) [Matters covered].

### Article SSC.9: Preventing of overlapping of benefits

Unless otherwise provided, this Protocol shall neither confer nor maintain the right to several benefits of the same kind for one and the same period of compulsory insurance.

## TITLE II: DETERMINATION OF THE LEGISLATION APPLICABLE

### Article SSC.10: General rules

1. Persons to whom this Protocol applies shall be subject to the legislation of a single State only. Such legislation shall be determined in accordance with this Title.
2. For the purposes of this Title, persons receiving cash benefits because or as a consequence of their activity as an employed or self-employed person shall be considered to be pursuing the said activity. This shall not apply to invalidity, old-age or survivors' pensions or to pensions in respect of accidents at work or occupational diseases or to sickness benefits in cash covering treatment for an unlimited period.
3. Subject to Articles SSC.12 [Pursuit of activities in two or more States] and SSC.13 [Voluntary insurance or optional continued insurance]:
  - (a) a person pursuing an activity as an employed or self-employed person in a State shall be subject to the legislation of that State;
  - (b) a civil servant shall be subject to the legislation of the State to which the administration employing them is subject;
  - (c) any other person to whom points (a) and (b) do not apply shall be subject to the legislation of the State of residence, without prejudice to other provisions of this Protocol guaranteeing them benefits under the legislation of one or more other States.
4. For the purposes of this Title, an activity as an employed or self-employed person normally pursued on board a vessel at sea flying the flag of a State shall be deemed to be an activity pursued in the said State. However, a person employed on board a vessel flying the flag of a State and remunerated for such activity by an undertaking or a person whose registered office or place of business is in another State shall be subject to the legislation of the latter State if that person resides in that State. The undertaking or person paying the remuneration shall be considered as the employer for the purposes of the said legislation.
5. An activity as a flight crew or cabin crew member performing air passenger or freight services shall be deemed to be an activity pursued in the State where the home base is located.

### Article SSC.11: Detached workers

1. By way of derogation from Article SSC.10(3) [General rules] and as a transitional measure in relation to the situation that existed before the entry into force of this Agreement, the following rules as regards the applicable legislation shall apply between the Member States listed in Category A of Annex SSC-8 [Transitional provisions regarding the application of Article SSC.11] and the United Kingdom:
  - (a) a person who pursues an activity as an employed person in a State for an employer which normally carries out its activities there and who is sent by that employer to another State to



perform work on that employer's behalf shall continue to be subject to the legislation of the first State, provided that:

- (i) the duration of such work does not exceed 24 months; and
  - (ii) that person is not sent to replace another detached worker.
- (b) a person who normally pursues an activity as a self-employed person in a State who goes to pursue a similar activity in another State shall continue to be subject to the legislation of the first State, provided that the anticipated duration of such activity does not exceed 24 months.

2. By the date of entry into force of this Agreement, the Union shall notify the United Kingdom which of the following categories each Member State falls under:

- (a) Category A: The Member State has notified the Union that it wishes to derogate from Article SSC.10 [General rules] in accordance with this article;
- (b) Category B: The Member State has notified the Union that it does not wish to derogate from Article SSC.10 [General rules]; or
- (c) Category C: The Member State has not indicated whether it wishes to derogate from Article SSC.10 [General rules] or not.

3. The document referred to in paragraph 2 shall become the content of Annex SSC-8 [Transitional provisions regarding the application of Article SSC.11] on the date of entry into force of this Agreement.

4. For Member States which are listed in Category A on the date of entry into force of this Agreement, points (a) and (b) of paragraph 1 shall apply.

5. For Member States which are listed in Category C on the date of entry into force of this Agreement, points (a) and (b) of paragraph 1 shall apply as though that Member State was listed in Category A for one month after the date of entry into force of this Agreement. The Specialised Committee on Social Security Coordination shall move a Member State from Category C to Category A if the Union notifies the Specialised Committee on Social Security Coordination that that Member State wishes to be so moved.

6. A month after the date of entry into force of this Agreement, Categories B and C will cease to exist. The Parties shall publish an updated Annex SSC-8 [Transitional provisions regarding the application of Article SSC.11] as soon as possible thereafter. For the purpose of paragraph 1, Annex [SSC-8] [Transitional provisions regarding the application of Article SSC.11] will be considered as containing only Category A Member States as from the date of that publication.

7. Where a person is in a situation referred to in paragraph 1 involving a Category C Member State before the publication of an updated Annex SSC-8 [Transitional provisions regarding the application of Article SSC.11] in accordance with paragraph 6, paragraph 1 shall continue to apply to that person for the duration of their activities under paragraph 1.

8. The Union shall notify the Specialised Committee on Social Security Coordination if a Member State wishes to be removed from Category A of Annex SSC-8 [Transitional provisions regarding the application of Article SSC.11] and the Specialised Committee on Social Security Coordination shall, at the request of the Union remove that Member State from Category A of Annex SSC-8. The Parties shall publish an updated Annex SSC-8 [Transitional provisions regarding the

application of Article SSC.11], which shall apply as from the first day of the second month following the receipt of the request by the Specialised Committee on Social Security Coordination.

9. Where a person is in a situation referred to in paragraph 1 before the publication of an updated Annex SSC-8 [Transitional provisions regarding the application of Article SSC.11] in accordance with paragraph 8, paragraph 1 shall continue to apply to that person for the duration of that person's activities under paragraph 1.

#### Article SSC.12: Pursuit of activities in two or more States

1. A person who normally pursues an activity as an employed person in one or more Member States as well as the United Kingdom shall be subject to:

- (a) the legislation of the State of residence if that person pursues a substantial part of their activity in that State; or
- (b) if that person does not pursue a substantial part of their activity in the State of residence:
  - (i) the legislation of the State in which the registered office or place of business of the undertaking or employer is situated if that person is employed by one undertaking or employer; or
  - (ii) the legislation of the State in which the registered office or place of business of the undertakings or employers is situated if that person is employed by two or more undertakings or employers which have their registered office or place of business in only one State; or
  - (iii) the legislation of the State in which the registered office or place of business of the undertaking or employer is situated other than the State of residence if that person is employed by two or more undertakings or employers, which have their registered office or place of business in a Member State and the United Kingdom, one of which is the State of residence; or
  - (iv) the legislation of the State of residence if that person is employed by two or more undertakings or employers, at least two of which have their registered office or place of business in different States other than the State of residence.

2. A person who normally pursues an activity as a self-employed person in one or more Member States as well as the United Kingdom shall be subject to:

- (a) the legislation of the State of residence if that person pursues a substantial part of their activity in that State; or
- (b) the legislation of the State in which the centre of interest of their activities is situated, if that person does not reside in one of the States in which that person pursues a substantial part of their activity.

3. A person who normally pursues an activity as an employed person and an activity as a self-employed person in two or more States shall be subject to the legislation of the State in which that person pursues an activity as an employed person or, if that person pursues such an activity in two or more States, to the legislation determined in accordance with paragraph 1.

4. A person who is employed as a civil servant by a State and who pursues an activity as an employed person or as a self-employed person in one or more other States shall be subject to the legislation of the State to which the administration employing that person is subject.

5. A person who normally pursues an activity as an employed person in two or more Member States (and not in the United Kingdom) shall be subject to the legislation of the United Kingdom if that person does not pursue a substantial part of that activity in the State of residence and that person:

- (a) is employed by one or more undertakings or employers, all of which have their registered office or place of business in the United Kingdom;
- (b) resides in a Member State and is employed by two or more undertakings or employers, all of which have their registered office or place of business in the United Kingdom and the Member State of residence;
- (c) resides in the United Kingdom and is employed by two or more undertakings or employers, at least two of which have their registered office or place of business in different Member States;  
or
- (d) resides in the United Kingdom and is employed by one or more undertakings or employers, none of which have a registered office or place of business in another State.

6. A person who normally pursues an activity as a self-employed person in two or more Member States (and not in the United Kingdom), without pursuing a substantial part of that activity in the State of residence, shall be subject to the legislation of the United Kingdom if the centre of interest of their activity is situated in the United Kingdom.

7. Paragraph 6 shall not apply in the case of a person who normally pursues an activity as an employed person and as a self-employed person in two or more Member States.

8. Persons referred to in paragraphs 1 to 6 shall be treated, for the purposes of the legislation determined in accordance with these provisions, as though they were pursuing all their activities as employed or self-employed persons and were receiving all their income in the State concerned.

#### Article SSC.13: Voluntary insurance or optional continued insurance

1. Articles SSC.10 [General rules] and SSC.12 [Pursuit of activities in two or more States] shall not apply to voluntary insurance or to optional continued insurance unless, in respect of one of the branches referred to in Article SSC.3 [Matters covered], only a voluntary scheme of insurance exists in a State.

2. Where, by virtue of the legislation of a State, the person concerned is subject to compulsory insurance in that State, that person may not be subject to a voluntary insurance scheme or an optional continued insurance scheme in another State. In all other cases in which, for a given branch, there is a choice between several voluntary insurance schemes or optional continued insurance schemes, the person concerned shall join only the scheme of their choice.

3. However, in respect of invalidity, old-age and survivors' benefits, the person concerned may join the voluntary or optional continued insurance scheme of a State, even if that person is compulsorily subject to the legislation of another State, provided that that person has been subject, at some stage in his or her career, to the legislation of the first State because or as a consequence of

an activity as an employed or self-employed person and if such overlapping is explicitly or implicitly allowed under the legislation of the first State.

4. Where the legislation of a State makes admission to voluntary insurance or optional continued insurance conditional upon residence in that State or upon previous activity as an employed or self-employed person, Article SSC.6(b) [Equal treatment of benefits, income, facts or events] shall apply only to persons who have been subject, at some earlier stage, to the legislation of that State on the basis of an activity as an employed or self-employed person.

#### Article SSC.14: Obligations of the employer

1. An employer who has its registered office or place of business outside the competent State shall fulfil all the obligations laid down by the legislation applicable to its employees, notably the obligation to pay the contributions provided for by that legislation, as if it had its registered office or place of business in the competent State.

2. An employer who does not have a place of business in the State whose legislation is applicable and the employee may agree that the latter may fulfil the employer's obligations on its behalf as regards the payment of contributions without prejudice to the employer's underlying obligations. The employer shall send notice of such an arrangement to the competent institution of that State.

### TITLE III: SPECIAL PROVISIONS CONCERNING THE VARIOUS CATEGORIES OF BENEFITS

#### CHAPTER 1: SICKNESS, MATERNITY AND EQUIVALENT PATERNITY BENEFITS

##### *Section 1: Insured persons and members of their families except pensioners and members of their families*

#### Article SSC.15: Residence in a State other than the competent State

An insured person or members of their family who reside in a State other than the competent State shall receive in the State of residence benefits in kind provided, on behalf of the competent institution, by the institution of the place of residence, in accordance with the provisions of the legislation it applies, as though that person were insured under the said legislation.

#### Article SSC.16: Stay in the competent State when residence is in another State – special rules for the members of the families of frontier workers

1. Unless otherwise provided for by paragraph 2, the insured person and the members of their family referred to in Article SSC.15 [Residence in a State other than the competent State] shall also be entitled to benefits in kind while staying in the competent State. The benefits in kind shall be provided by the competent institution and at its own expense, in accordance with the provisions of the legislation it applies, as though the persons concerned resided in that State.

2. The members of the family of a frontier worker shall be entitled to benefits in kind during their stay in the competent State.

Where the competent State is listed in Annex SSC-2 [Restriction of rights to benefits in kind for members of the family of a frontier worker] however, the members of the family of a frontier worker who reside in the same State as the frontier worker shall be entitled to benefits in kind in the competent State only under the conditions laid down in Article SSC.17(1) [Stay outside the competent State].

#### Article SSC.17: Stay outside the competent State

1. Unless otherwise provided for by paragraph 2, an insured person and the members of their family staying in a State other than the competent State shall be entitled to benefits in kind, provided on behalf of the competent institution by the institution of the place of stay in accordance with its legislation, as though the person were insured under that legislation, where:
  - (a) the benefits in kind become necessary on medical grounds during their stay, in the opinion of the provider of the benefits in kind, taking into account the nature of the benefits and the expected length of the stay;
  - (b) the person did not travel to that State with the purpose of receiving the benefits in kind, unless the person is a passenger or member of the crew on a vessel or aircraft travelling to that State and the benefits in kind became necessary on medical grounds during the voyage or flight; and
  - (c) a valid entitlement document is presented in accordance with Article SSCI.22(1) [Stay in a State other than the competent State] of Annex SSC-7 [Implementing Part].
2. Appendix SSCI-2 [Entitlement document] lists benefits in kind which, in order to be provided during a stay in another State, require for practical reasons a prior agreement between the person concerned and the institution providing the care.

#### Article SSC.18: Travel with the purpose of receiving benefits in kind – authorisation to receive appropriate treatment outside the State of residence

1. Unless otherwise provided for by this Protocol, an insured person travelling to another State with the purpose of receiving benefits in kind during the stay shall seek authorisation from the competent institution.
2. An insured person who is authorised by the competent institution to go to another State with the purpose of receiving the treatment appropriate to their condition shall receive the benefits in kind provided, on behalf of the competent institution, by the institution of the place of stay, in accordance with the provisions of the legislation it applies, as though that person were insured under the said legislation. The authorisation shall be accorded where the treatment in question is among the benefits provided for by the legislation in the State where the person concerned resides and where that person cannot be given such treatment within a time limit which is medically justifiable, taking into account their current state of health and the probable course of their illness.
3. Paragraphs 1 and 2 shall apply *mutatis mutandis* to the members of the family of an insured person.
4. If the members of the family of an insured person reside in a State other than the State in which the insured person resides, and this State has opted for reimbursement on the basis of fixed amounts, the cost of the benefits in kind referred to in paragraph 2 shall be borne by the institution of the place of residence of the members of the family. In this case, for the purposes of paragraph 1, the institution of the place of residence of the members of the family shall be considered to be the competent institution.

#### Article SSC.19: Cash benefits

1. An insured person and members of their family residing or staying in a State other than the competent State shall be entitled to cash benefits provided by the competent institution in accordance with the legislation it applies. By agreement between the competent institution and the institution of the place of residence or stay, such benefits may, however, be provided by the institution of the place of residence or stay at the expense of the competent institution in accordance with the legislation of the competent State.
2. The competent institution of a State whose legislation stipulates that the calculation of cash benefits shall be based on average income or on an average contribution basis shall determine such average income or average contribution basis exclusively by reference to the incomes confirmed as having been paid, or contribution bases applied, during the periods completed under the said legislation.
3. The competent institution of a State whose legislation provides that the calculation of cash benefits shall be based on standard income shall take into account exclusively the standard income or, where appropriate, the average of standard incomes for the periods completed under the said legislation.
4. Paragraphs 2 and 3 shall apply *mutatis mutandis* to cases where the legislation applied by the competent institution lays down a specific reference period which corresponds in the case in question either wholly or partly to the periods which the person concerned has completed under the legislation of one or more other States.

#### Article SSC.20: Pension claimants

1. An insured person who, on making a claim for a pension, or during the investigation thereof, ceases to be entitled to benefits in kind under the legislation of the State last competent, shall remain entitled to benefits in kind under the legislation of the State in which that person resides, provided that the pension claimant satisfies the insurance conditions of the legislation of the State referred to in paragraph 2. The right to benefits in kind in the State of residence shall also apply to the members of the family of the pension claimant.
2. The benefits in kind shall be chargeable to the institution of the State which, in the event of a pension being awarded, would become competent under Articles SSC.21 [Right to benefits in kind under the legislation of the State of residence] to SSC.23 [Pensions under the legislation of one or more States other than the State of residence, where there is a right to benefits in kind in the latter State].

#### *Section 2: Special provisions for pensioners and members of their families*

##### Article SSC.21: Right to benefits in kind under the legislation of the State of residence

A person who receives a pension or pensions under the legislation of two or more States, of which one is the State of residence, and who is entitled to benefits in kind under the legislation of that State, shall, with the members of their family, receive such benefits in kind from and at the expense of the institution of the place of residence, as though that person were a pensioner whose pension was payable solely under the legislation of that State.

Article SSC.22: No right to benefits in kind under the legislation of the State of residence

1. A person who:

- (a) resides in a State;
- (b) receives a pension or pensions under the legislation of one or more States; and
- (c) is not entitled to benefits in kind under the legislation of the State of residence,

shall nevertheless receive such benefits for themselves and the members of their family, insofar as the pensioner would be entitled to them under the legislation of the State competent in respect of their pension or at least one of the States competent, if that person resided in that State. The benefits in kind shall be provided at the expense of the institution referred to in paragraph 2 by the institution of the place of residence, as though the person concerned were entitled to a pension and entitled to benefits in kind under the legislation of that State.

2. In the cases covered by paragraph 1, the cost of the benefits in kind shall be borne by the institution as determined in accordance with the following rules:

- (a) where the pensioner is treated as if he or she were entitled to benefits in kind under the legislation of one State, the cost of those benefits shall be borne by the competent institution of that State;
- (b) where the pensioner is treated as if he or she were entitled to benefits in kind under the legislation of two or more States, the cost of those benefits shall be borne by the competent institution of the State to whose legislation the person has been subject for the longest period of time;
- (c) if the application of the rule in subparagraph (b) would result in several States being responsible for the cost of those benefits, the cost shall be borne by the competent institution of the State to whose legislation the pensioner was last subject.

Article SSC.23: Pensions under the legislation of one or more States other than the State of residence, where there is a right to benefits in kind in the latter State

Where a person receiving a pension or pensions under the legislation of one or more States resides in a State under whose legislation the right to receive benefits in kind is not subject to conditions of insurance, or conditions of activity as an employed or self-employed person, and that person does not receive a pension from the State of residence, the cost of benefits in kind provided to them and to members of their family shall be borne by the institution of one of the States competent in respect of their pensions determined in accordance with Article SSC.22(2) [No right to benefits in kind under the legislation of the State of residence], to the extent that the person and the members of their family would be entitled to such benefits if that person resided in that State.

Article SSC.24: Residence of members of the family in a State other than the one in which the pensioner resides

Where a person:

- (a) receives a pension or pensions under the legislation of one or more States; and
- (b) resides in a State other than the one in which members of his or her family reside,



those members of that person's family shall be entitled to receive benefits in kind from the institution of the place of their residence in accordance with the legislation it applies insofar as the pensioner is entitled to benefits in kind under the legislation of a State. The costs shall be borne by the competent institution responsible for the costs of the benefits in kind provided to the pensioner in their State of residence.

Article SSC.25: Stay of the pensioner or the members of their family in a State other than the State of residence – stay in the competent State – authorisation for appropriate treatment outside the State of residence

1. Article SSC.17 [Stay outside the competent State] shall apply *mutatis mutandis* to:
  - (a) a person receiving a pension or pensions under the legislation of one or more States and who is entitled to benefits in kind under the legislation of one of the States which provide their pension(s);
  - (b) the members of their family,  
  
who are staying in a State other than the one in which they reside.
2. Article SSC.16(1) [Stay in the competent State when residence is in another State – special rules for the members of the families of frontier workers] shall apply *mutatis mutandis* to the persons described in paragraph 1 when they stay in the State in which is situated the competent institution responsible for the cost of the benefits in kind provided to the pensioner in his or her State of residence and that State has opted for this and is listed in Annex SSC-3 [More rights for pensioners returning to the competent State].
3. Article SSC.18 [Travel with the purpose of receiving benefits in kind – authorisation to receive appropriate treatment outside the State of residence] shall apply *mutatis mutandis* to a pensioner or members of his or her family who are staying in a State other than the one in which they reside with the purpose of receiving in that State the treatment appropriate to their condition.
4. Unless otherwise provided for by paragraph 5, the cost of the benefits in kind referred to in paragraphs 1 to 3 shall be borne by the competent institution responsible for the cost of benefits in kind provided to the pensioner in their State of residence.
5. The cost of the benefits in kind referred to in paragraph 3 shall be borne by the institution of the place of residence of the pensioner or of the members of their family, if these persons reside in a State which has opted for reimbursement on the basis of fixed amounts. In these cases, for the purposes of paragraph 3, the institution of the place of residence of the pensioner or of the members of their family shall be considered to be the competent institution.

Article SSC.26: Cash benefits for pensioners

1. Cash benefits shall be paid to a person receiving a pension or pensions under the legislation of one or more States by the competent institution of the State in which is situated the competent institution responsible for the cost of benefits in kind provided to the pensioner in their State of residence. Article SSC.19 [Cash benefits] shall apply *mutatis mutandis*.
2. Paragraph 1 shall also apply to the members of a pensioner's family.



## Article SSC.27: Contributions by pensioners

1. The institution of a State which is responsible under the legislation it applies for making deductions in respect of contributions for sickness, maternity and equivalent paternity benefits, may request and recover such deductions, calculated in accordance with the legislation it applies, only to the extent that the cost of the benefits pursuant to Articles SSC.21 [Right to benefits in kind under the legislation of the State of residence] to SSC.24 [Residence of members of the family in a State other than the one in which the pensioner resides] is to be borne by an institution of that State.
2. Where, in the cases referred to in Article SSC.23 [Pensions under the legislation of one or more States other than the State of residence, where there is a right to benefits in kind in the latter State], the acquisition of sickness, maternity and equivalent paternity benefits is subject to the payment of contributions or similar payments under the legislation of a State in which the pensioner concerned resides, these contributions shall not be payable by virtue of such residence.

### *Section 3: Common provisions*

## Article SSC.28: General provisions

Articles SSC.21 [Right to benefits in kind under the legislation of the State of residence] to SSC.27 [Contributions by pensioners] shall not apply to a pensioner or the members of their family who are entitled to benefits under the legislation of a State on the basis of an activity as an employed or self-employed person. In such a case, the person concerned shall be subject, for the purposes of this Chapter, to Articles SSC.15 [Residence in a State other than the competent State] to SSC.19 [Cash benefits].

### Article SSC.29: Prioritising of the right to benefits in kind – special rule for the right of members of the family to benefits in the State of residence

1. Unless otherwise provided for by paragraph 2, where a member of the family has an independent right to benefits in kind based on the legislation of a State or on this Chapter such right shall take priority over a derivative right to benefits in kind for members of the family.
2. Unless otherwise provided for by paragraph 3, where the independent right in the State of residence exists directly and solely on the basis of the residence of the person concerned in that State, a derivative right to benefits in kind shall take priority over the independent right.
3. Notwithstanding paragraphs 1 and 2, benefits in kind shall be provided to the members of the family of an insured person at the expense of the competent institution in the State in which they reside, where:
  - (a) those members of the family reside in a State under whose legislation the right to benefits in kind is not subject to conditions of insurance or activity as an employed or self-employed person; and
  - (b) the spouse or the person caring for the children of the insured person pursues an activity as an employed or self-employed person in that State, or receives a pension from that State on the basis of an activity as an employed or self-employed person.

## Article SSC.30: Reimbursements between institutions

1. The benefits in kind provided by the institution of a State on behalf of the institution of another State under this Chapter shall give rise to full reimbursement.

2. The reimbursements referred to in paragraph 1 shall be determined and effected in accordance with the arrangements set out in Annex SSC-7 [Implementing Part], either on production of proof of actual expenditure, or on the basis of fixed amounts for States whose legal or administrative structures are such that the use of reimbursement on the basis of actual expenditure is not appropriate.

3. The States, and their competent authorities, may provide for other methods of reimbursement or waive all reimbursement between the institutions coming under their jurisdiction.

## CHAPTER 2: BENEFITS IN RESPECT OF ACCIDENTS AT WORK AND OCCUPATIONAL DISEASES

### Article SSC.31: Right to benefits in kind and in cash

1. Without prejudice to any more favourable provisions in paragraphs 2 and 3 of this Article, Articles SSC.15 [Residence in a State other than the competent State], SSC.16(1) [Stay in the competent State when residence is in another State – special rules for the members of the families of frontier workers], SSC.17(1) [Stay outside the competent State] and 18(1) [Travel with the purpose of receiving benefits in kind – authorisation to receive appropriate treatment outside the State of residence] shall also apply to benefits relating to accidents at work or occupational diseases.

2. A person who has sustained an accident at work or has contracted an occupational disease and who resides or stays in a State other than the competent State shall be entitled to the special benefits in kind of the scheme covering accidents at work and occupational diseases provided, on behalf of the competent institution, by the institution of the place of residence or stay in accordance with the legislation which it applies, as though that person were insured under that legislation.

3. The competent institution may not refuse to grant the authorisation provided for in Article SSC.18(1) [Travel with the purpose of receiving benefits in kind – authorisation to receive appropriate treatment outside the State of residence] to a person who has sustained an accident at work or who has contracted an occupational disease and is entitled to benefits chargeable to that institution, where the treatment appropriate to his or her condition cannot be given in the State in which that person resides within a time limit which is medically justifiable, taking into account that person's current state of health and the probable course of the illness.

4. Article SSC.19 [Cash benefits] also applies to benefits falling within this Chapter.

### Article SSC.32: Costs of transport

1. The competent institution of a State whose legislation provides for meeting the costs of transporting a person who has sustained an accident at work or is suffering from an occupational disease, either to their place of residence or to a hospital, shall meet such costs to the corresponding place in the State where the person resides, provided that that institution gives prior authorisation for such transport, duly taking into account the reasons justifying it. Such authorisation shall not be required in the case of a frontier worker.

2. The competent institution of a State whose legislation provides for meeting the costs of transporting the body of a person killed in an accident at work to the place of burial shall, in accordance with the legislation it applies, meet such costs to the corresponding place in the State where the person was residing at the time of the accident.

Article SSC.33: Benefits for an occupational disease where the person suffering from such a disease has been exposed to the same risk in several States

When a person who has contracted an occupational disease has, under the legislation of two or more States, pursued an activity which by its nature is likely to cause the said disease, the benefits that that person or his or her survivors may claim shall be provided exclusively under the legislation of the last of those States whose conditions are satisfied.

Article SSC.34: Aggravation of an occupational disease

In the event of aggravation of an occupational disease for which a person suffering from such a disease has received or is receiving benefits under the legislation of a State, the following rules shall apply:

- (a) if the person concerned, while in receipt of benefits, has not pursued, under the legislation of another State, an activity as an employed or self-employed person likely to cause or aggravate the disease in question, the competent institution of the first State shall bear the cost of the benefits under the provisions of the legislation which it applies, taking into account the aggravation;
- (b) if the person concerned, while in receipt of benefits, has pursued such an activity under the legislation of another State, the competent institution of the first State shall bear the cost of the benefits under the legislation it applies without taking the aggravation into account. The competent institution of the second State shall grant a supplement to the person concerned, the amount of which shall be equal to the difference between the amount of benefits due after the aggravation and the amount which would have been due prior to the aggravation under the legislation it applies, if the disease in question had occurred under the legislation of that State;
- (c) the rules concerning reduction, suspension or withdrawal laid down by the legislation of a State shall not be invoked against persons receiving benefits provided by institutions of two States in accordance with point (b).

Article SSC.35: Rules for taking into account the special features of certain legislation

1. If there is no insurance against accidents at work or occupational diseases in the State in which the person concerned resides or stays, or if such insurance exists but there is no institution responsible for providing benefits in kind, those benefits shall be provided by the institution of the place of residence or stay responsible for providing benefits in kind in the event of sickness.
2. If there is no insurance against accidents at work or occupational diseases in the competent State, the provisions of this Chapter concerning benefits in kind shall nevertheless be applied to a person who is entitled to those benefits in the event of sickness, maternity or equivalent paternity under the legislation of that State if that person sustains an accident at work or suffers from an occupational disease during a residence or stay in another State. Costs shall be borne by the institution that is competent for the benefits in kind under the legislation of the competent State.
3. Article SSC.6 [Equal treatment of benefits, income, facts or events] shall apply to the competent institution in a State as regards the equivalence of accidents at work and occupational diseases which either have occurred or have been confirmed subsequently under the legislation of another State when assessing the degree of incapacity, the right to benefits or the amount thereof, on condition that:

- (a) no compensation is due in respect of an accident at work or an occupational disease which had occurred or had been confirmed previously under the legislation it applies; and
- (b) no compensation is due in respect of an accident at work or an occupational disease which had occurred or had been confirmed subsequently, under the legislation of the other State under which the accident at work or the occupational disease had occurred or been confirmed.

#### Article SSC.36: Reimbursements between institutions

1. Article SSC.30 [Reimbursements between institutions] shall also apply to benefits falling within this Chapter, and reimbursement shall be made on the basis of actual costs.
2. The States, or their competent authorities, may provide for other methods of reimbursement or waive all reimbursement between the institutions under their jurisdiction.

### CHAPTER 3: DEATH GRANTS

Article SSC.37: Right to grants where death occurs in, or where the person entitled resides in, a State other than the competent one

1. When an insured person or a member of their family dies in a State other than the competent State, the death shall be deemed to have occurred in the competent State.
2. The competent institution shall be obliged to provide death grants payable under the legislation it applies, even if the person entitled resides in a State other than the competent State.
3. Paragraphs 1 and 2 shall also apply when the death is the result of an accident at work or an occupational disease.

#### Article SSC.38: Provision of benefits in the event of the death of a pensioner

1. In the event of the death of a pensioner who was entitled to a pension under the legislation of one State, or to pensions under the legislations of two or more States, when that pensioner was residing in a State other than that of the institution responsible for the cost of benefits in kind provided under Articles SSC.22 [No right to benefits in kind under the legislation of the State of residence] and SSC.23 [Pensions under the legislation of one or more States other than the State of residence, where there is a right to benefits in kind in the latter State], the death grants payable under the legislation administered by that institution shall be provided at its own expense as though the pensioner had been residing at the time of their death in the State in which that institution is situated.
2. Paragraph 1 shall apply *mutatis mutandis* to the members of the family of a pensioner.

### CHAPTER 4: INVALIDITY BENEFITS

#### Article SSC.39: Calculation of invalidity benefits

Without prejudice to Article SSC.7 [Aggregation of periods], where, under the legislation of the State competent under Title II [Determination of the legislation applicable] of this Protocol, the amount of invalidity benefits is dependent on the duration of the periods of insurance, employment, self-employment or residence, the competent State is not required to take into account any such periods

completed under the legislation of another State for the purposes of calculating the amount of invalidity benefit payable.

#### Article SSC.40: Special provisions on aggregation of periods

The competent institution of a State whose legislation makes the acquisition, retention or recovery of the right to benefits conditional upon the completion of periods of insurance or residence shall, where necessary, apply Article SSC.46 [Special provisions on aggregation of periods] *mutatis mutandis*.

#### Article SSC.41: Aggravation of invalidity

In the case of aggravation of an invalidity for which a person is receiving benefits under the legislation of a State in accordance with this Protocol, the benefit shall continue to be provided in accordance with this Chapter, taking the aggravation into account.

#### Article SSC.42: Conversion of invalidity benefits into old-age benefits

1. Where provided for in the legislation of the State paying invalidity benefit in accordance with this Protocol, invalidity benefits shall be converted into old-age benefits under the conditions laid down by the legislation under which they are provided and in accordance with Chapter 5 [Old-age and survivors' pensions].

2. Where a person receiving invalidity benefits can establish a claim to old-age benefits under the legislation of one or more other States, in accordance with Article SSC.45 [General provisions], any institution which is responsible for providing invalidity benefits under the legislation of a State shall continue to provide such a person with the invalidity benefits to which he or she is entitled under the legislation it applies until paragraph 1 becomes applicable in respect of that institution, or otherwise for as long as the person concerned satisfies the conditions for such benefits.

#### Article SSC.43: Special provisions for civil servants

Articles SSC.7 [Aggregation of periods], SSC.39 [Calculation of invalidity benefits], SSC.41 [Aggravation of invalidity], SSC.42 [Conversion of invalidity benefits into old-age benefits] and paragraphs 2 and 3 of Article SSC.55 [Special provisions for civil servants] shall apply *mutatis mutandis* to persons covered by a special scheme for civil servants.

### CHAPTER 5: OLD-AGE AND SURVIVORS' PENSIONS

#### Article SSC.44: Taking into account child-raising periods

1. Where, under the legislation of the State which is competent under Title II [Determination of the legislation applicable], no child-raising period is taken into account, the institution of the State whose legislation, according to Title II [Determination of the legislation applicable], was applicable to the person concerned on the grounds that he or she was pursuing an activity as an employed or self-employed person at the date when, under that legislation, the child-raising period started to be taken into account for the child concerned, shall remain responsible for taking into account that period as a child-raising period under its own legislation, as if such child-raising took place in its own territory.

2. Paragraph 1 shall not apply if the person concerned is, or becomes, subject to the legislation of another State due to the pursuit of an employed or self-employed activity.

#### Article SSC.45: General provisions

1. All the competent institutions shall determine entitlement to benefit, under all the legislations of the States to which the person concerned has been subject, when a request for award has been submitted, unless the person concerned expressly requests deferment of the award of old-age benefits under the legislation of one or more States.
2. If at a given moment the person concerned does not satisfy, or no longer satisfies, the conditions laid down by all the legislations of the States to which that person has been subject, the institutions applying legislation the conditions of which have been satisfied shall not take into account, when performing the calculation in accordance with points (a) or (b) of Article SSC.47(1) [Award of benefits], the periods completed under the legislations the conditions of which have not been satisfied, or are no longer satisfied, where this gives rise to a lower amount of benefit.
3. Paragraph 2 shall apply *mutatis mutandis* when the person concerned has expressly requested deferment of the award of old-age benefits.
4. A new calculation shall be performed automatically as and when the conditions to be fulfilled under the other legislations are satisfied or when a person requests the award of an old-age benefit deferred in accordance with paragraph 1, unless the periods completed under the other legislations have already been taken into account by virtue of paragraphs 2 or 3.

#### Article SSC.46: Special provisions on aggregation of periods

1. Where the legislation of a State makes the granting of certain benefits conditional upon the periods of insurance having been completed only in a specific activity as an employed or self-employed person or in an occupation which is subject to a special scheme for employed or self-employed persons, the competent institution of that State shall take into account periods completed under the legislation of other States only if completed under a corresponding scheme or, failing that, in the same occupation, or where appropriate, in the same activity as an employed or self-employed person.

If, account having been taken of the periods thus completed, the person concerned does not satisfy the conditions for receipt of the benefits of a special scheme, these periods shall be taken into account for the purposes of providing the benefits of the general scheme or, failing that, of the scheme applicable to manual or clerical workers, as the case may be, provided that the person concerned had been affiliated to one or other of those schemes.

2. The periods of insurance completed under a special scheme of a State shall be taken into account for the purposes of providing the benefits of the general scheme or, failing that, of the scheme applicable to manual or clerical workers, as the case may be, of another State, provided that the person concerned had been affiliated to one or other of those schemes, even if those periods have already been taken into account in the latter State under a special scheme.

3. Where the legislation or specific scheme of a State makes the acquisition, retention or recovery of the right to benefits conditional upon the person concerned being insured at the time of the materialisation of the risk, this condition shall be regarded as having been satisfied if that person has been previously insured under the legislation or specific scheme of that State and is, at the time of the materialisation of the risk, insured under the legislation of another State for the same risk or, failing that, if a benefit is due under the legislation of another State for the same risk. The latter condition shall, however, be deemed to be fulfilled in the cases referred to in Article SSC.52 [Periods of insurance or residence of less than one year].

## Article SSC.47: Award of benefits

1. The competent institution shall calculate the amount of the benefit that would be due:
  - (a) under the legislation it applies, only where the conditions for entitlement to benefits have been satisfied exclusively under national law (independent benefit);
  - (b) by calculating a theoretical amount and subsequently an actual amount (pro rata benefit), as follows:
    - (i) the theoretical amount of the benefit is equal to the benefit which the person concerned could claim if all the periods of insurance or of residence which have been completed under the legislations of the other States had been completed under the legislation it applies on the date of the award of the benefit. If, under this legislation, the amount does not depend on the duration of the periods completed, that amount shall be regarded as being the theoretical amount;
    - (ii) the competent institution shall then establish the actual amount of the pro rata benefit by applying to the theoretical amount the ratio between the duration of the periods completed before materialisation of the risk under the legislation it applies and the total duration of the periods completed before materialisation of the risk under the legislations of all the States concerned.
2. Where appropriate, the competent institution shall apply, to the amount calculated in accordance with points (a) and (b) of paragraph 1, all the rules relating to reduction, suspension or withdrawal, under the legislation it applies, within the limits provided for by Articles SSC.48 [Rules to prevent overlapping] to SSC.50 [Overlapping of benefits of a different kind].
3. The person concerned shall be entitled to receive from the competent institution of each State the higher of the amounts calculated in accordance with points (a) and (b) of paragraph 1.
4. Where the calculation pursuant to point (a) of paragraph 1 in one State invariably results in the independent benefit being equal to or higher than the pro rata benefit, calculated in accordance with point (b) of paragraph 1, the competent institution shall waive the pro rata calculation, provided that:
  - (a) such a situation is set out in Part 1 of Annex SSC-4 [Cases in which the pro rata calculation shall be waived or shall not apply].
  - (b) no legislation containing rules against overlapping, as referred to in Articles SSC.49 [Overlapping of benefits of the same kind] and SSC.50 [Overlapping of benefits of a different kind], is applicable unless the conditions laid down in Article SSC.50(2) [Overlapping of benefits of a different kind], are fulfilled; and
  - (c) Article SSC.52 [Periods of insurance or residence of less than one year] is not applicable in relation to periods completed under the legislation of another State in the specific circumstances of the case.
5. Notwithstanding the provisions of paragraphs 1, 2 and 3, the pro rata calculation shall not apply to schemes providing benefits in respect of which periods of time are of no relevance to the calculation, subject to such schemes being listed in part 2 of Annex SSC-4 [Cases in which the pro rata calculation shall be waived or shall not apply]. In such cases, the person concerned shall be entitled to the benefit calculated in accordance with the legislation of the State concerned.



#### Article SSC.48: Rules to prevent overlapping

1. Any overlapping of old-age and survivors' benefits calculated or provided on the basis of periods of insurance or residence completed by the same person shall be considered to be overlapping of benefits of the same kind.
2. Overlapping of benefits which cannot be considered to be of the same kind within the meaning of paragraph 1 shall be considered to be overlapping of benefits of a different kind.
3. The following provisions shall be applicable for the purposes of rules to prevent overlapping laid down by the legislation of a State in the case of overlapping of a benefit in respect of old-age or survivors with a benefit of the same kind or a benefit of a different kind or with other income:
  - (a) the competent institution shall take into account the benefits or incomes acquired in another State only where the legislation it applies provides for benefits or income acquired abroad to be taken into account;
  - (b) the competent institution shall take into account the amount of benefits to be paid by another State before deduction of tax, social security contributions and other individual levies or deductions, unless the legislation it applies provides for the application of rules to prevent overlapping after such deductions, under the conditions and the procedures laid down in Annex SSC-7 [Implementing Part];
  - (c) the competent institution shall not take into account the amount of benefits acquired under the legislation of another State on the basis of voluntary insurance or continued optional insurance;
  - (d) if a single State applies rules to prevent overlapping because the person concerned receives benefits of the same or of a different kind under the legislation of other States or income acquired in other States, the benefit due may be reduced solely by the amount of such benefits or such income.

#### Article SSC.49: Overlapping of benefits of the same kind

1. Where benefits of the same kind due under the legislation of two or more States overlap, the rules to prevent overlapping laid down by the legislation of a State shall not be applicable to a pro rata benefit.
2. The rules to prevent overlapping shall apply to an independent benefit only if the benefit concerned is:
  - (a) a benefit the amount of which does not depend on the duration of periods of insurance or residence; or
  - (b) a benefit the amount of which is determined on the basis of a credited period deemed to have been completed between the date on which the risk materialised and a later date, overlapping with:
    - (i) a benefit of the same type, except where an agreement has been concluded between two or more States to avoid the same credited period being taken into account more than once; or
    - (ii) a benefit referred to in point (a).



The benefits and agreements referred to in points (a) and (b) are listed in Annex SSC-5 [Benefits and agreements which allow the application of Article SSC.49 [Overlapping of benefits of the same kind]].

#### Article SSC.50: Overlapping of benefits of a different kind

1. If the receipt of benefits of a different kind or other income requires the application of the rules to prevent overlapping provided for by the legislation of the States concerned regarding:

- (a) two or more independent benefits, the competent institutions shall divide the amounts of the benefit or benefits or other income, as they have been taken into account, by the number of benefits subject to the said rules;

however, the application of this subparagraph cannot deprive the person concerned of their status as a pensioner for the purposes of the other chapters of this Title under the conditions and the procedures laid down in Annex SSC-7 [Implementing Part];

- (b) one or more pro rata benefits, the competent institutions shall take into account the benefit or benefits or other income and all the elements stipulated for applying the rules to prevent overlapping as a function of the ratio between the periods of insurance or residence established for the calculation referred to in point (b)(ii) of Article SSC.47(1) [Award of benefits];
- (c) one or more independent benefits and one or more pro rata benefits, the competent institutions shall apply *mutatis mutandis* point (a) as regards independent benefits and point (b) as regards pro rata benefits.

2. The competent institution shall not apply the division stipulated in respect of independent benefits, if the legislation it applies provides for account to be taken of benefits of a different kind or other income and all other elements for calculating part of their amount determined as a function of the ratio between periods of insurance or residence referred to in point (b)(ii) of Article SSC.47(1) [Award of benefits].

3. Paragraphs 1 and 2 shall apply *mutatis mutandis* where the legislation of one or more States provides that a right to a benefit cannot be acquired in the case where the person concerned is in receipt of a benefit of a different kind, payable under the legislation of another State, or of other income.

#### Article SSC.51: Additional provisions for the calculation of benefits

1. For the calculation of the theoretical and pro rata amounts referred to in point (b) of Article SSC.47(1) [Award of benefits], the following rules shall apply:

- (a) where the total length of the periods of insurance or residence completed before the risk materialised under the legislations of all the States concerned is longer than the maximum period required by the legislation of one of these States for receipt of full benefit, the competent institution of that State shall take into account this maximum period instead of the total length of the periods completed; this method of calculation shall not result in the imposition on that institution of the cost of a benefit greater than the full benefit provided for by the legislation it applies. This provision shall not apply to benefits the amount of which does not depend on the length of insurance;
- (b) the procedure for taking into account overlapping periods is laid down in Annex SSC-7 [Implementing Part];

(c) if the legislation of a State provides that the benefits are to be calculated on the basis of incomes, contributions, bases of contributions, increases, earnings, other amounts or a combination of more than one of them (average, proportional, fixed or credited), the competent institution shall:

- (i) determine the basis for calculation of the benefits in accordance only with periods of insurance completed under the legislation it applies;
- (ii) use, in order to determine the amount to be calculated in accordance with the periods of insurance or residence completed under the legislation of the other States, the same elements determined or recorded for the periods of insurance completed under the legislation it applies;

where necessary in accordance with the procedures laid down in Annex SSC-6 [Special provisions for the application of the legislation of the Member States and of the United Kingdom] for the State concerned;

(d) in the event that point (c) is not applicable because the legislation of a State provides for the benefit to be calculated on the basis of elements other than periods of insurance or residence which are not linked to time, the competent institution shall take into account, in respect of each period of insurance or residence completed under the legislation of any other State, the amount of the capital accrued, the capital which is considered as having been accrued or any other element for the calculation under the legislation it administers divided by the corresponding units of periods in the pension scheme concerned.

2. The provisions of the legislation of a State concerning the revalorisation of the elements taken into account for the calculation of benefits shall apply, as appropriate, to the elements to be taken into account by the competent institution of that State, in accordance with paragraph 1, in respect of the periods of insurance or residence completed under the legislation of other States.

#### Article SSC.52: Periods of insurance or residence of less than one year

1. Notwithstanding point (b) of Article SSC.47(1) [Award of benefits], the institution of a State shall not be required to provide benefits in respect of periods completed under the legislation it applies which are taken into account when the risk materialises, if:

- (a) the duration of the said periods is less than one year, and
- (b) taking only these periods into account no right to benefit is acquired under that legislation.

For the purposes of this Article, 'periods' shall mean all periods of insurance, employment, self-employment or residence which either qualify for, or directly increase, the benefit concerned.

2. The competent institution of each of the States concerned shall take into account the periods referred to in paragraph 1, for the purposes of point (b)(i) of Article SSC.47(1) [Award of benefits].

3. If the effect of applying paragraph 1 would be to relieve all the institutions of the States concerned of their obligations, benefits shall be provided exclusively under the legislation of the last of those States whose conditions are satisfied, as if all the periods of insurance and residence completed and taken into account in accordance with Articles SSC.7 [Aggregation of periods] and SSC.46(1) and (2) [Special provisions on aggregation of periods] had been completed under the legislation of that State.

4. This Article shall not apply to schemes listed in Part 2 [Cases in which Article 47(5) applies] of Annex SSC-4 [Cases in which the pro rata calculation shall be waived or shall not apply].

#### Article SSC.53: Award of a supplement

1. A recipient of benefits to whom this Chapter applies may not, in the State of residence and under whose legislation a benefit is payable to them, be provided with a benefit which is less than the minimum benefit fixed by that legislation for a period of insurance or residence equal to all the periods taken into account for the payment in accordance with this Chapter.

2. The competent institution of that State shall pay them throughout the period of their residence in its territory a supplement equal to the difference between the total of the benefits due under this Chapter and the amount of the minimum benefit.

#### Article SSC.54: Recalculation and revaluation of benefits

1. If the method for determining benefits or the rules for calculating benefits are altered under the legislation of a State, or if the personal situation of the person concerned undergoes a relevant change which, under that legislation, would lead to an adjustment of the amount of the benefit, a recalculation shall be carried out in accordance with Article SSC.47 [Award of benefits].

2. On the other hand, if, by reason of an increase in the cost of living or changes in the level of income or other grounds for adjustment, the benefits of the State concerned are altered by a percentage or fixed amount, such percentage or fixed amount shall be applied directly to the benefits determined in accordance with Article SSC.47 [Award of benefits], without the need for a recalculation.

#### Article SSC.55: Special provisions for civil servants

1. Articles SSC.7 [Aggregation of periods], SSC.45 [General provisions], SSC.46(3) [Special provisions on aggregation of periods] and SSC.47 [Award of benefits] to SSC.54 [Recalculation and revaluation of benefits] shall apply *mutatis mutandis* to persons covered by a special scheme for civil servants.

2. However, if the legislation of a competent State makes the acquisition, liquidation, retention or recovery of the right to benefits under a special scheme for civil servants subject to the condition that all periods of insurance be completed under one or more special schemes for civil servants in that State, or be regarded by the legislation of that State as equivalent to such periods, the competent institution of that State shall take into account only the periods which can be recognised under the legislation it applies.

If, account having been taken of the periods thus completed, the person concerned does not satisfy the conditions for the receipt of these benefits, these periods shall be taken into account for the award of benefits under the general scheme or, failing that, the scheme applicable to manual or clerical workers, as the case may be.

3. Where, under the legislation of a State, benefits under a special scheme for civil servants are calculated on the basis of the last salary or salaries received during a reference period, the competent institution of that State shall take into account, for the purposes of the calculation, only those salaries, duly revalued, which were received during the period or periods for which the person concerned was subject to that legislation.

### CHAPTER 6: UNEMPLOYMENT BENEFITS

#### Article SSC.56: Special provisions on aggregation of periods of insurance, employment or self-employment

1. The competent institution of a State whose legislation makes the acquisition, retention, recovery or duration of the right to benefits conditional upon the completion of either periods of insurance, employment or self-employment shall, to the extent necessary, take into account periods of insurance, employment or self-employment completed under the legislation of any other State as though they were completed under the legislation it applies.

However, when the applicable legislation makes the right to benefits conditional on the completion of periods of insurance, the periods of employment or self-employment completed under the legislation of another State shall not be taken into account unless such periods would have been considered to be periods of insurance had they been completed in accordance with the applicable legislation.

2. The application of paragraph 1 of this Article shall be conditional on the person concerned having the most recently completed, in accordance with the legislation under which the benefits are claimed:

- (a) periods of insurance, if that legislation requires periods of insurance,
- (b) periods of employment, if that legislation requires periods of employment, or
- (c) periods of self-employment, if that legislation requires periods of self-employment.

#### Article SSC.57: Calculation of unemployment benefits

1. Where the calculation of unemployment benefits is based on the amount of the previous salary or professional income of the person concerned, the competent State shall take into account the salary or professional income received by the person concerned based exclusively on their last activity as an employed or self-employed person under the legislation of the competent State.

2. Where the legislation applied by the competent State provides for a specific reference period for the determination of the salary or professional income used to calculate the amount of benefit, and the person concerned was subject to the legislation of another State for all or part of that reference period, the competent State shall only take into account the salary or professional income received during their last activity as an employed or self-employed person under that legislation.

### CHAPTER 7: PRE-RETIREMENT BENEFITS

#### Article SSC.58: Benefits

When the applicable legislation makes the right to pre-retirement benefits conditional on the completion of periods of insurance, of employment or of self-employment, Article SSC.7 [Aggregation of periods] shall not apply.

### TITLE IV: MISCELLANEOUS PROVISIONS

#### Article SSC.59: Cooperation

1. The competent authorities of the States shall notify the Specialised Committee on Social Security Coordination of any changes to their legislation as regards the branches of social security

covered by Article SSC.3 [Matters covered] which are relevant to or may affect the implementation of this Protocol.

2. Unless this Protocol requires such information to be notified to the Specialised Committee on Social Security Coordination, the competent authorities of the States shall communicate to each other measures taken to implement this Protocol that are not notified under paragraph 1 and that are relevant for the implementation of the Protocol.

3. For the purposes of this Protocol, the authorities and institutions of the Member States and of the United Kingdom shall lend one another their good offices and act as though implementing their own legislation. The administrative assistance given by the said authorities and institutions shall, as a rule, be free of charge. However, the Specialised Committee on Social Security Coordination shall establish the nature of reimbursable expenses and the limits above which their reimbursement is due.

4. The authorities and institutions of the States may, for the purposes of this Protocol, communicate directly with one another and with the persons involved or their representatives.

5. The institutions and persons covered by this Protocol shall have a duty of mutual information and cooperation to ensure the correct implementation of this Protocol.

The institutions, in accordance with the principle of good administration, shall respond to all queries within a reasonable period of time and shall in this connection provide the persons concerned with any information required for exercising the rights conferred on them by this Protocol.

The persons concerned must inform the institutions of the competent State and of the State of residence as soon as possible of any change in their personal or family situation which affects their right to benefits under this Protocol.

6. Failure to respect the obligation of information referred to in the third subparagraph of paragraph 5 may result in the application of proportionate measures in accordance with national law. Nevertheless, these measures shall be equivalent to those applicable to similar situations under domestic law and shall not make it impossible or excessively difficult in practice for claimants to exercise the rights conferred on them by this Protocol.

7. In the event of difficulties in the interpretation or application of this Protocol which could jeopardise the rights of a person covered by it, the institution of the competent State or of the State of residence of the person concerned, shall contact the institution(s) of the State(s) concerned. If a solution cannot be found within a reasonable period, a Party may request to hold consultations in the framework of the Specialised Committee on Social Security Coordination.

8. The authorities, institutions and tribunals of one State may not reject applications or other documents submitted to them on the grounds that they are written in an official language of the Union, including in English.

#### Article SSC.60: Data processing

1. The States shall progressively use new technologies for the exchange, access and processing of the data required to apply this Protocol.

2. Each State shall be responsible for managing its own part of the data-processing services.

3. An electronic document sent or issued by an institution in conformity with the Protocol and Annex SSC-7 [Implementing Part] may not be rejected by any authority or institution of another State on the grounds that it was received by electronic means, once the receiving institution has declared that it can receive electronic documents. Reproduction and recording of such documents shall be presumed to be a correct and accurate reproduction of the original document or representation of the information it relates to, unless there is proof to the contrary.

4. An electronic document shall be considered valid if the computer system on which the document is recorded contains the safeguards necessary in order to prevent any alteration, disclosure or unauthorised access to the recording. It shall at any time be possible to reproduce the recorded information in an immediately readable form.

#### Article SSC.61: Exemptions

1. Any exemption from or reduction of taxes, stamp duty, notarial or registration fees provided for under the legislation of one State in respect of certificates or documents required to be produced in application of the legislation of that State shall be extended to similar certificates or documents required to be produced in application of the legislation of another State or of this Protocol.

2. All statements, documents and certificates of any kind whatsoever required to be produced in application of this Protocol shall be exempt from authentication by diplomatic or consular authorities.

#### Article SSC.62: Claims, declarations or appeals

Any claim, declaration or appeal which should have been submitted, in application of the legislation of one State, within a specified period to an authority, institution or tribunal of that State shall be admissible if it is submitted within the same period to a corresponding authority, institution or tribunal of another State. In such a case, the authority, institution or tribunal receiving the claim, declaration or appeal shall forward it without delay to the competent authority, institution or tribunal of the former State either directly or through the competent authorities of the States concerned. The date on which such claims, declarations or appeals were submitted to the authority, institution or tribunal of the second State shall be considered as the date of their submission to the competent authority, institution or tribunal.

#### Article SSC.63: Medical examinations

1. Medical examinations provided for by the legislation of one State may be carried out, at the request of the competent institution, in the territory of another State, by the institution of the place of stay or residence of the person entitled to benefits, under the conditions laid down in Annex SSC-7 [Implementing Part] or agreed between the competent authorities of the States concerned.

2. Medical examinations carried out under the conditions laid down in paragraph 1 shall be considered as having been carried out in the territory of the competent State.

#### Article SSC.64: Collection of contributions and recovery of benefits

1. Collection of contributions due to an institution of one State and recovery of benefits provided by the institution of one State but not due, may be effected in another State in accordance with the procedures and with the guarantees and privileges applicable to the collection of contributions due to the corresponding institution of the latter and the recovery of benefits provided by it but not due.

2. Enforceable decisions of the judicial and administrative authorities relating to the collection of contributions, interest and any other charges or to the recovery of benefits provided but not due under the legislation of one State shall be recognised and enforced at the request of the competent institution in another State within the limits and in accordance with the procedures laid down by the legislation and any other procedures applicable to similar decisions of the latter. Such decisions shall be declared enforceable in that State insofar as the legislation and any other procedures of that State so require.

3. Claims of an institution of one State shall in enforcement, bankruptcy or settlement proceedings in another State enjoy the same privileges as the legislation that the latter accords to claims of the same kind.

4. The procedure for implementing this Article, including costs reimbursement, shall be governed by Annex SSC-7 [Implementing Part] or, where necessary and as a complementary measure, by means of agreements between the States.

#### Article SSC.65: Rights of institutions

1. If a person receives benefits under the legislation of a State in respect of an injury resulting from events occurring in another State, any rights of the institution responsible for providing benefits against a third party liable to provide compensation for the injury shall be governed by the following rules:

- (a) where the institution responsible for providing benefits is, under the legislation it applies, subrogated to the rights which the beneficiary has against the third party, such subrogation shall be recognised by each State;
- (b) where the institution responsible for providing benefits has a direct right against the third party, each State shall recognise such rights.

2. If a person receives benefits under the legislation of one State in respect of an injury resulting from events occurring in another State, the provisions of the said legislation which determine the cases in which the civil liability of employers or of their employees is to be excluded shall apply with regard to the said person or to the competent institution.

Paragraph 1 shall also apply to any rights of the institution responsible for providing benefits against employers or their employees in cases where their liability is not excluded.

3. Where, in accordance with Articles SSC.30(3) [Reimbursements between institutions] or 36(2) [Reimbursements between institutions], two or more States or their competent authorities have concluded an agreement to waive reimbursement between institutions under their jurisdiction, or, where reimbursement does not depend on the amount of benefits actually provided, any rights arising against a liable third party shall be governed by the following rules:

- (a) where the institution of the State of residence or stay grants benefits to a person in respect of an injury sustained in its territory, that institution, in accordance with the provisions of the legislation it applies, shall exercise the right to subrogation or direct action against the third party liable to provide compensation for the injury;
- (b) for the application of (a):
  - (i) the person receiving benefits shall be deemed to be insured with the institution of the place of residence or stay, and



- (ii) that institution shall be deemed to be the institution responsible for providing benefits;
- (c) paragraphs 1 and 2 shall remain applicable in respect of any benefits not covered by the waiver agreement or a reimbursement which does not depend on the amount of benefits actually provided.

#### Article SSC.66: Implementation of legislation

Special provisions for implementing the legislation of a certain State are referred to in Annex SSC-6 [Special provisions for the application of the legislation of the Member States and of the United Kingdom].

### TITLE V: FINAL PROVISIONS

#### Article SSC.67: Protection of individual rights

1. The Parties shall ensure in accordance with their domestic legal orders that the provisions of the Protocol on Social Security Coordination have the force of law, either directly or through domestic legislation giving effect to these provisions, so that legal or natural persons can invoke the said provisions before domestic courts, tribunals and administrative authorities.
2. The Parties shall ensure the means for legal and natural persons to effectively protect their rights under this Protocol, such as the possibility to address complaints to administrative bodies or to bring legal action before a competent court or tribunal in an appropriate judicial procedure, in order to seek an adequate and timely remedy.

#### Article SSC.68: Amendments

The Specialised Committee on Social Security Coordination may amend the Annexes and Appendices to this Protocol.

#### Article SSC.69: Termination of this Protocol

Without prejudice to Article FINPROV.8 [Termination], each Party may at any moment terminate this Protocol, by written notification through diplomatic channels. In that event, this Protocol shall cease to be in force on the first day of the ninth month following the date of notification.

#### Article SSC.70: Sunset clause

1. This Protocol shall cease to apply fifteen years after the entry into force of this Agreement.
2. Not less than 12 months before this Protocol ceases to apply in accordance with paragraph 1, either Party shall notify the other Party of its wish to enter into negotiations with a view to concluding an updated Protocol.

#### Article SSC.71: Post-termination arrangements

When this Protocol ceases to apply pursuant to Article SSC.69 [Termination of this Protocol], Article SSC.70 [Sunset clause] or Article FINPROV.8 [Termination], the rights of insured persons regarding entitlements which are based on periods completed or facts or events that occurred before this Protocol ceases to apply shall be retained. The Partnership Council may lay down additional



arrangements setting out appropriate consequential and transitional arrangements in good time before this Protocol ceases to apply.

*ANNEX SSC-1: CERTAIN BENEFITS IN CASH TO WHICH THE PROTOCOL SHALL NOT APPLY*

Part 1: Special non-contributory cash benefits (point (a) for Article SSC.3(4)[Matters covered])

(i) UNITED KINGDOM

- (a) State Pension Credit (State Pension Credit Act 2002 and State Pension Credit Act (Northern Ireland) 2002)
- (b) Income-based allowances for jobseekers (Jobseekers Act 1995 and Jobseekers (Northern Ireland) Order 1995)
- (c) Disability Living Allowance, mobility component (Social Security Contributions and Benefits Act 1992 and Social Security Contributions and Benefits (Northern Ireland) Act 1992)
- (d) Personal Independence Payment, mobility component (Welfare Reform Act 2012 (Part 4) and Welfare Reform (Northern Ireland) Order 2015 (Part 5))
- (e) Employment and Support Allowance Income-related (Welfare Reform Act 2007 and Welfare Reform Act (Northern Ireland) 2007)
- (f) Best Start Foods payment (Welfare Foods (Best Start Foods) (Scotland) Regulations 2019 (SSI 2019/193))
- (g) Best Start Grants (pregnancy and baby grant, early learning grant, school-age grant) (The Early Years Assistance (Best Start Grants) (Scotland) Regulations 2018 (SSI 2018/370))
- (h) Funeral Support Payment (Funeral Expense Assistance (Scotland) Regulations 2019 (SSI 2019/292)).

(ii) MEMBER STATES

AUSTRIA

Compensatory supplement (Federal Act of 9 September 1955 on General Social Insurance — ASVG, Federal Act of 11 October 1978 on Social insurance for persons engaged in trade and commerce — GSVG and Federal Act of 11 October 1978 on Social insurance for farmers — BSVG).

BELGIUM

- (a) Income replacement allowance (Law of 27 February 1987)
- (b) Guaranteed income for elderly persons (Law of 22 March 2001).

BULGARIA

Social Pension for old age (Article 89 of the Social Insurance Code).

CYPRUS

- (a) Social Pension (Social Pension Law of 1995 (Law 25(I)/95), as amended)
- (b) Severe motor disability allowance (Council of Ministers' Decisions Nos 38210 of 16 October 1992, 41370 of 1 August 1994, 46183 of 11 June 1997 and 53675 of 16 May 2001)
- (c) Special grant to blind persons (Special Grants Law of 1996 (Law 77(I)/96), as amended).

## CZECH REPUBLIC

Social allowance (State Social Support Act No 117/1995 Sb.).

## DENMARK

Accommodation expenses for pensioners (Law on individual accommodation assistance, consolidated by Law No 204 of 29 March 1995).

## ESTONIA

- (a) Disabled adult allowance (Social Benefits for Disabled Persons Act of 27 January 1999)
- (b) State unemployment allowance (Labour Market Services and Support Act of 29 September 2005).

## FINLAND

- (a) Housing allowance for pensioners (Act concerning the Housing Allowance for pensioners, 571/2007)
- (b) Labour market support (Act on Unemployment Benefits 1290/2002)
- (c) Special assistance for immigrants (Act on Special Assistance for Immigrants, 1192/2002).

## FRANCE

- (a) Supplementary allowances of:

- (i) the Special Invalidation Fund; and
- (ii) the Old Age Solidarity Fund in respect of acquired rights

(Law of 30 June 1956, codified in Book VIII of the Social Security Code);

- (b) Disabled adults' allowance (Law of 30 June 1975, codified in Book VIII of the Social Security Code)
- (c) Special allowance (Law of 10 July 1952, codified in Book VIII of the Social Security Code) in respect of acquired rights
- (d) Old-age solidarity allowance (ordinance of 24 June 2004, codified in Book VIII of the Social Security Code) as of 1 January 2006.

## GERMANY

- (a) Basic subsistence income for the elderly and for persons with reduced earning capacity under Chapter 4 of Book XII of the Social Code
- (b) Benefits to cover subsistence costs under the basic provision for jobseekers unless, with respect to these benefits, the eligibility requirements for a temporary supplement following receipt of unemployment benefit (Article 24(1) of Book II of the Social Code) are fulfilled.

## GREECE

Special benefits for the elderly (Law 1296/82).

## HUNGARY

- (a) Invalidity annuity (Decree No 83/1987 (XII 27) of the Council of Ministers on Invalidity Annuity)
- (b) Non-contributory old age allowance (Act III of 1993 on Social Administration and Social Benefits)
- (c) Transport allowance (Government Decree No 164/1995 (XII 27) on Transport Allowances for Persons with Severe Physical Handicap).

## IRELAND

- (a) Jobseekers' allowance (Social Welfare Consolidation Act 2005, Part 3, Chapter 2)
- (b) State pension (non-contributory) (Social Welfare Consolidation Act 2005, Part 3, Chapter 4)
- (c) Widow's (non-contributory) pension and widower's (non-contributory) pension (Social Welfare Consolidation Act 2005, Part 3, Chapter 6)
- (d) Disability allowance (Social Welfare Consolidation Act 2005, Part 3, Chapter 10)
- (e) Mobility allowance (Health Act 1970, Section 61)
- (f) Blind pension (Social Welfare Consolidation Act 2005, Part 3, Chapter 5).

## ITALY

- (a) Social pensions for persons without means (Law No 153 of 30 April 1969)
- (b) Pensions and allowances for the civilian disabled or invalids (Laws No 118 of 30 March 1971, No 18 of 11 February 1980 and No 508 of 23 November 1988)
- (c) Pensions and allowances for the deaf and dumb (Laws No 381 of 26 May 1970 and No 508 of 23 November 1988)
- (d) Pensions and allowances for the civilian blind (Laws No 382 of 27 May 1970 and No 508 of 23 November 1988)
- (e) Benefits supplementing the minimum pensions (Laws No 218 of 4 April 1952, No 638 of 11 November 1983 and No 407 of 29 December 1990)
- (f) Benefits supplementing disability allowances (Law No 222 of 12 June 1984)
- (g) Social allowance (Law No 335 of 8 August 1995)
- (h) Social increase (Article 1(1) and (12) of Law No 544 of 29 December 1988 and successive amendments).

## LATVIA

- (a) State Social Security Benefit (Law on State Social Benefits of 1 January 2003)
- (b) Allowance for the compensation of transportation expenses for disabled persons with restricted mobility (Law on State Social Benefits of 1 January 2003).

## LITHUANIA

- (a) Social assistance pension (Law of 2005 on State Social Assistance Benefits, Article 5)
- (b) Relief compensation (Law of 2005 on State Social Assistance Benefits, Article 15)
- (c) Transport compensation for the disabled who have mobility problems (Law of 2000 on Transport Compensation, Article 7).

#### LUXEMBOURG

Income for the seriously disabled (Article 1(2), Law of 12 September 2003), with the exception of persons recognised as being disabled workers and employed on the mainstream labour market or in a sheltered environment.

#### MALTA

- (a) Supplementary allowance (Section 73 of the Social Security Act (Cap. 318) 1987)
- (b) Age pension (Social Security Act (Cap. 318) 1987).

#### NETHERLANDS

- (a) Work and Employment Support for Disabled Young Persons Act of 24 April 1997 (Wet Wajong)
- (b) Supplementary Benefits Act of 6 November 1986 (TW).

#### POLAND

Social pension (Act of 27 June 2003 on social pensions).

#### PORTUGAL

- (a) Non-contributory State old-age and invalidity pension (Decree-Law No 464/80 of 13 October 1980)
- (b) Non-contributory widowhood pension (Regulatory Decree No 52/81 of 11 November 1981)
- (c) Solidarity supplement for the elderly (Decree – Law No 232/2005 of 29 December 2005, amended by Decree – Law No 236/2006 of 11 December 2006).

#### SLOVAKIA

- (a) Adjustment awarded before 1 January 2004 to pensions constituting the sole source of income
- (b) Social pension which has been awarded before 1 January 2004.

#### SLOVENIA

- (a) State pension (Pension and Disability Insurance Act of 23 December 1999)
- (b) Income support for pensioners (Pension and Disability Insurance Act of 23 December 1999)
- (c) Maintenance allowance (Pension and Disability Insurance Act of 23 December 1999).

#### SPAIN

- (a) Minimum income guarantee (Law No 13/82 of 7 April 1982)

- (b) Cash benefits to assist the elderly and invalids unable to work (Royal Decree No 2620/81 of 24 July 1981):
  - (i) Non-contributory invalidity and retirement pensions as provided for in Article 38(1) of the Consolidated Text of the General Law on Social Security, approved by Royal Legislative Decree No 1/1994 of 20 June 1994; and
  - (ii) the benefits which supplement the above pensions, as provided for in the legislation of the Comunidades Autónomas, where such supplements guarantee a minimum subsistence income having regard to the economic and social situation in the Comunidades Autónomas concerned;
- (c) Allowances to promote mobility and to compensate for transport costs (Law No 13/1982 of 7 April 1982).

SWEDEN

- (a) Housing supplements for persons receiving a pension (Law 2001:761);
- (b) Financial support for the elderly (Law 2001:853).

Part 2: Long-term care benefits (point (d) of Article SSC.3(4) [Matters covered] of the Protocol)

- (i) UNITED KINGDOM
  - (a) Attendance Allowance (Social Security Contributions and Benefits Act 1992, Social Security (Attendance Allowance) Regulations 1991, Social Security Contributions and Benefits (Northern Ireland) Act 1992 and Social Security (Attendance Allowance) Regulations (Northern Ireland) 1992)
  - (b) Carer's Allowance (Social Security Contributions and Benefits Act 1992, The Social Security (Invalid Care Allowance) Regulations 1976, Social Security Contributions and Benefits (Northern Ireland) Act 1992) and The Social Security (Invalid Care Allowance) Regulations 1976 (Northern Ireland)
  - (c) Disability Living Allowance, care component (Social Security Contributions and Benefits Act 1992, Social Security (Disability Living Allowance) Regulations 1991, Social Security Contributions and Benefits (Northern Ireland) Act 1992 and Social Security (Disability Living Allowance) Regulations (Northern Ireland) 1992)
  - (d) Personal Independence Payment, daily living component (Welfare Reform Act 2012 (Part 4), Social Security (Personal Independence Payment) Regulations 2013, The Personal Independence Payment (Transitional Provisions) Regulations 2013, Personal Independence Payment (Transitional Provisions) (Amendment) Regulations 2019, Welfare Reform (Northern Ireland) Order 2015 (Part 5), The Personal Independence Payment Regulations (Northern Ireland) 2016, The Personal Independence Payment (Transitional Provisions) Regulations (Northern Ireland) 2016 and Personal Independence Payment (Transitional Provisions) (Amendment) Regulations (Northern Ireland) 2019)
  - (e) Carer's Allowance Supplement (The Social Security (Scotland) Act 2018)

- (f) Young Carer's Grant (The Carer's Assistance (Young Carer Grants) (Scotland) Regulations 2020 (as amended)).

(ii) MEMBER STATES

AUSTRIA

- (a) Federal Long-term care allowance Act (Bundespflegegeldgesetz, BPGG), original version BGBl. no. 110/1993, last amendment BGBl- I no. 100/2016
- (b) Regulation on the staging of the Federal long-term care allowance (Einstufungsverordnung zum Bundespflegegeldgesetz (EinstV)):
- (c) Regulation of the Federal minister for Labour, Social affairs and Consumer protection on needs assessments of care for children and young people in accordance with the Federal Nursing Care Act. (Bundespflegegeldgesetz , Kinder-EinstV)
- (d) Numerous applicable statutory bases, e.g. Agreement between the Federal Government and the Länder on joint measures for persons in need of care. Social Assistance Acts and Disability Acts of the Länder
- (e) Care Fund Law (Pflegefondsgesetz, PFG), Original version: Official Journal (BGBl. I) No. 57/2011
- (f) Care Services Statistics Ordinance 2012 (Pflegedienstleistungsstatistik-Verordnung 2012)
- (g) Support for the 24-hour care: Federal Long-term care allowance Act (Bundespflegegeldgesetz,BPGG):
- (h) Guidelines for the support of the 24-hour care (§ 21b of the Federal Long-term care allowance Act (Bundespflegegeldgesetz))
- (i) Guidelines for granting benefits to support caring family members (§ 21a of the Federal Long-term care allowance Act (Bundespflegegeldgesetz))
- (j) Care recourse interdiction
- (k) Federal Act on a specific supplement due to the abolition of access to funds when housing people in inpatient care facilities
- (l) Federal Act on a specific supplement due to the abolition of access to funds when housing people in inpatient care facilities for 2019 and 2020, BGBl. I No 95/2019.

BELGIUM

- (a) Health Care and Sickness Benefit Compulsory Insurance Act (Loi relative à l'assurance obligatoire soins de santé et indemnités/Wet betreffende de verplichte verzekering voor geneeskundige verzorging en uitkeringen), coordinated on 14 July 1994
- (b) Act of 27 February 1987 on allowances for persons with disabilities (Loi relative aux allocations aux personnes handicapées/Wet betreffende de tegemoetkomingen aan gehandicapten)

- (c) Flemish social protection (Vlaamse sociale bescherming): Decree of the Flemish Parliament of 18 May 2018 on the organisation of Flemish social protection (Decreet houdende Vlaamse sociale bescherming/) and Orders of the Flemish government of 30 November 2018
- (d) Walloon Code for Social Action and Health (Code wallon de l'Action sociale et de la Santé), decretal part. Part 1, book IIIter, instituted by Decree of 8 November 2018
- (e) Walloon Regulatory Code for Social Action and Health, part I/1 instituted by Walloon Government Decree of 21 December 2018
- (f) Decree of 13 December 2018 on offers to elderly or dependent persons as well as on palliative care (Dekret über die Angebote für Senioren und Personen mit Unterstützungsbedarf sowie über die Palliativpflege)
- (g) Decree of 4th June 2007 on psychiatric nursing homes (Dekret über die psychiatrischen Pflegewohnheime)
- (h) Government Decree of 20 June 2017 on mobility aids (Erlass über die Mobilitätshilfen)
- (i) Decree of 13 December 2016 on the establishment of a German Community Office for self-determined life (Dekret zur Schaffung einer Dienststelle der Deutschsprachigen Gemeinschaft für selbstbestimmtes Leben)
- (j) Royal Decree of 5th March 1990 on the allowance for assistance to the elderly (Arrêté royal du 5 mars 1990 relatif à l'allocation pour l'aide aux personnes âgées)
- (k) Government Decree of 19 December 2019 on transitional arrangements relating to the procedure for obtaining a prior authorization or an approval for the coverage or the sharing of costs of long-term rehabilitation abroad (Erlass der Regierung zur übergangsweisen Regelung des Verfahrens zur Erlangung einer Vorabgeehmigung oder Zustimmung zwecks Kostenübernahme oder Kostenbeteiligung für eine Langzeitrehabilitation im Ausland)
- (l) Order of 21 December 2018 on Brussels health insurance bodies in the field of health care and assistance to people (Ordonnance du 21 décembre 2018 relative aux organismes assureurs bruxellois dans le domaine des soins de santé et de l'aide aux personnes)
- (m) Cooperation between federated entities:
- (n) Cooperation agreement of 31 December 2018 between the Flemish Community, the Walloon Region, the French Community Commission, the Joint Community Commission and the German-speaking Community concerning mobility aids
- (o) Cooperation agreement of 31 December 2018 between the Flemish Community, the Walloon Region, the French Community, the Joint Community Commission, the French Community Commission and the German-speaking Community concerning the financing of care when using care institutions located outside the limits of the federated entity.

#### BULGARIA

- (a) Social Insurance Code (Кодекс за социално осигуряване), 1999 title amended 2003
- (b) Law on Social Assistance (Закон за социално подпомагане), 1998
- (c) Regulation on the Implementation of the Law on Social Assistance (Правилник за прилагане на Закона за социално подпомагане), 1998



- (d) Law on Integration of People with Disabilities 2019 (Закон за хората с увреждания), 2019
- (e) Personal Assistance Act 2019 (Закон за личната помощ) 2019 which will enter into force on 1st September 2019
- (f) Regulation on the Implementation of the Law on Integration of People with Disabilities (Правилник за прилагане на Закона за интеграция на хората с увреждания), 2004
- (g) Ordinance on the medical expertise (Наредба за медицинската експертиза) 2010
- (h) Tariff of the Fees for Social Services Financed by the State Budget (Тарифа за таксите за социални услуги, финансирани от държавния бюджет), 2003.

#### CROATIA

- (a) Social Welfare Act (Zakon o socijalnoj skrbi) of 2013, OJ no. 157/13, 152/14, 99/15, 52/16, 16/17, 130/17 and 98/19)
- (b) Foster Families Act (Zakon o udomiteljstvu) OJ no. 90/11 and 78/12, as amended
- (c) Ordinance on minimum requirements for delivery of social services (Pravilnik o minimalnim uvjetima za pružanje socijalnih usluga) of 2014, OJ no 40/14 and 66/15
- (d) Ordinance on participation and method of payment of beneficiaries in the maintenance costs of accommodation outside the family (Pravilnik o sudjelovanju i načinu plaćanja korisnika I drugih obveznika uzdržavanja u troškovima smještaja izvan vlastite obitelji) of 1998, OJ no. 112/98 and 05/02, as amended
- (e) Ordinance on the content and manner of keeping records of individuals who are professionally engaged in social services delivery as a profession (Pravilnik o sadržaju I načinu vođenja evidencije fizičkih osoba koje profesionalno pružaju socijalne usluge) of 2015, OJ no. 66/15.

#### CYPRUS

- (a) Social Welfare Services (Υπηρεσίες Κοινωνικής Ευημερίας):
- (b) The Guaranteed Minimum Income and in General the Social Benefits (Emergency Needs and Care Needs) Regulations and Decrees as they are amended or superseded. Homes for the Elderly and Disabled Persons Laws (Οι περί Στεγών για Ηλικιωμένους και Αναπήρους Νόμοι) of 1991 - 2011.[L. 222/91 and L. 65(I)/2011]
- (c) Adult Day-Care Centres Laws (Οι περί Κέντρων Ενηλίκων Νόμοι)(L. 38(I)/1997 and L.64(I)/2011).
- (d) State Aid Scheme, under the Regulation 360/2012 for the provision of services of general economic interest (De minimis) [Σχέδιο Κρατικών Ενισχύσεων Ήσσονος Σημασίας, βάση του Κανονισμού 360/2012 για την παροχή υπηρεσιών γενικού οικονομικού συμφέροντος]
- (e) Welfare Benefits Administration Service (Υπηρεσία Διαχείρισης Επιδομάτων Πρόνοιας):
- (f) The Guaranteed Minimum Income and generally for Welfare Benefits Law of 2014 as it is amended or superseded
- (g) The Guaranteed Minimum Income and generally for Welfare Benefits Regulations and Decrees as they are amended or superseded.

## CZECH REPUBLIC

- (a) Act. No. 108/2006 on social services (Zákon o sociálních službách)
- (b) Act No. 372/2011 on Health Services (Zákon o zdravotních službách)
- (c) Act No. 48/1997 on Public Health Insurance (Zákon o veřejném zdravotním pojištění).

## DENMARK

- (a) Consolidated Act No 988 of 17 August 2017 on Social Services (om social service)
- (b) Consolidated Act No 119 of 1 February 2019 on Social Housing (om almene boliger).

## ESTONIA

Social Welfare Act (Sotsiaalhoolekande seadus) 2016.

## FINLAND

- (a) Services and Assistance for the Disabled Act (Laki vammaisuuden perusteella järjestettävistä palveluista ja tukitoimista) of 3 April 1987
- (b) Act on Supporting the Functional Capacity of the Ageing Population and on Social and Health Care Services for Older People (Laki ikääntyneen väestön toimintakyvyn tukemisesta sekä iäkkäiden sosiaali- ja terveyspalveluista) of 28 December 2012
- (c) Social Welfare Act (Sosiaalihuoltolaki) of 30 December 2014
- (d) Health Care Act (Terveystieteidenhuoltolaki) of 30 December 2010
- (e) Primary Health Care Act (Kansanterveyslaki) of 28 January 1972
- (f) Act on Informal Care Support (Laki omaishoidon tuesta) of 2 December 2005
- (g) Family Care Act (Perhehoitolaki) of 20 March 2015.

## FRANCE

- (a) Supplement for a third party (majoration pour tierce personne, MTP):
- (b) Articles L. 341-4 and L. 355-1 of the Social Security Code (Code de la sécurité sociale)
- (c) Supplementary benefit for recourse to a third party (prestation complémentaire pour recours à tierce personne): Article L. 434-2 of the Social Security Code
- (d) Special education supplement for a disabled child (complément d'allocation d'éducation de l'enfant handicapé): Article L. 541-1 of the Social Security Code
- (e) Disability compensation allowance (prestation de compensation du handicap, PCH): Articles L. 245-1 to L. 245-14 of the Social action and Family Code (Code de l'action sociale et des familles).
- (f) Allowance for loss of autonomy (allocation personnalisée d'autonomie, APA): Articles L. 232-1 to L. 232-28 of the Social action and Family Code (Code de l'action sociale et des familles).

## GERMANY

- (a) Long-term care insurance (Pflegeversicherung):
- (b) Social long-term care insurance for persons insured under statutory sickness insurance and private compulsory long-term care insurance for persons insured under private sickness insurance: Social Code Sozialgesetzbuch, Book XI (SGB XI), last amended by Article 2 of the Act of 21 December 2019 (BGBl. I p. 2913).

#### GREECE

- (a) Law No. 1140/1981, as amended
- (b) Legislative Decree No. 162/73 and Joint Ministerial Decision No. Π4β/5814/1997
- (c) Ministerial Decision No. Π1γ/ΑΓΠ/οικ.14963 of 9 October 2001
- (d) Law No. 4025/2011
- (e) Law No. 4109/2013
- (f) Law No. 4199/2013 art. 127
- (g) Law No. 4368/2016 art. 334
- (h) Law No. 4483/2017 art. 153
- (i) Law No. 498/1-11-2018, art. 28, 30 and 31, for the "Unified Health Benefits Regulation" of the National Service Provider Organization Health (EOPYY).

#### HUNGARY

- (a) Long-term care services providing personal social care (social services):
- (b) Act III of 1993 on Social Administration and Social Assistance (törvény a szociális igazgatásról és szociális ellátásokról) supplemented by Government and Ministerial decrees.

#### IRELAND

- (a) Health Act 1970 (No. 1 of 1970)
- (b) Nursing Homes Support Scheme Act 2009 (No. 15 of 2009)
- (c) Social Welfare Consolidation Act 2005:
- (d) Constant Attendance Allowance
- (e) Carer's Benefit
- (f) Carer's Allowance
- (g) Carer's Support Grant
- (h) Domiciliary Care Allowance.

#### ITALY

- (a) Law No. 118 of 30 March 1971 on civilian invalidity benefits (Legge 30 Marzo 1971, n. 118 - Conversione in Legge del D.L. 30 gennaio 1971, n. 5 e nuove norme in favore dei mutilati ed invalidi civili)

- (b) Law No. 18 of 11 February 1980 on Constant attendance allowance (Legge 11 Febbraio 1980, n. 18 - Indennità di accompagnamento agli invalidi civili totalmente inabili)
- (c) Law No. 104 of 5 February 1992, Article 33 (Framework law on disability) (Legge 5 Febbraio 1992, n. 104 - Legge-quadro per l'assistenza, l'integrazione sociale e i diritti delle persone handicappate)
- (d) Legislative Decree No. 112 of 31 March 1998 on the transfer of legislative tasks and administrative competences from the State to the Regions and local entities (Decreto Legislativo 31 Marzo 1998, n. 112 - Conferimento di funzioni e compiti amministrativi dello Stato alle regioni ed agli enti locali, in attuazione del capo I della Legge 15 Marzo 1997, n. 59)
- (e) Regulation (CE) 883/04.on social security coordination of the European Parliament and Council (Regolamento (CE) 883 del 29 aprile 2004 del Parlamento Europeo e del Consiglio, relativo al coordinamento dei sistemi di sicurezza sociale - SNCB – art 70 and Annex X)
- (f) Law No. 183 of 4 November 2010, Article 24, modifying the rules regarding the permits for the assistance to disabled persons in difficult situations (Legge n. 183 del 4 Novembre 2010, art. 24 - Modifiche alla disciplina in materia di permessi per l'assistenza a portatori di handicap in situazione di gravità)
- (g) Law No. 147 of 27 December 2013 containing provisions for drawing up the annual and pluri-annual budget of the State – Stability Law 2014 (Disposizioni per la formazione del bilancio annuale e pluriennale dello Stato - Legge di stabilità 2014).

#### LATVIA

- (a) Law on Social Services and Social Assistance (Sociālo pakalpojumu un sociālās palīdzības likums) 31/10/2002
- (b) Medical Treatment Law (Ārstniecības likums) 12/06/1997
- (c) Law on Patient Rights (Pacientu tiesību likums) 30/12/2009
- (d) Regulations of the Cabinet of Ministers No. 555 on Health care organisation and payment procedure (Ministru kabineta 2018. gada 28.augusta noteikumi Nr.555 “Veselības aprūpes pakalpojumu organizēšanas un samaksas kārtība”) 28/08/2018
- (e) Regulations of the Cabinet of Ministers No. 275 on Procedures for Payment of Social Care and Social Rehabilitation Services and the Procedures for Covering Service Costs from a Local Government Budget (Ministru kabineta 2003.gada 27.maija noteikumi Nr.275 „Sociālās aprūpes un sociālās rehabilitācijas pakalpojumu samaksas kārtība un kārtība, kādā pakalpojuma izmaksas tiek segtas no pašvaldības budžeta”) 27/05/2003
- (f) Regulations of the Cabinet of Ministers No.138 on Receiving of Social Services and Social Assistance (Ministru kabineta 2019.gada 2.aprīļa noteikumi Nr 138 “Noteiku mi par sociālo pakalpojumu un sociālās palīdzības saņemšanu”) 02/04/2019.

#### LITHUANIA

- (a) Law on Target compensations (Tikslinių kompensacijų įstatymas) of 29 June 2016 (No. XII-2507)
- (b) Law on Social Services (Socialinių paslaugų įstatymas) of 19 January 2006 (No. X-493)

- (c) Law on Health Insurance (Sveikatos draudimo įstatymas) of 21 May 1996 (No I-1343)
- (d) Law on Healthcare system (Sveikatos sistemos įstatymas) of 19 July 1994 (No I-552)
- (e) Law on Health Care Institutions (Sveikatos priežiūros įstaigų įstatymas) of 6 June 1996 (No. I-1367).

#### LUXEMBOURG

Law of 19 June 1998 introducing the dependency insurance, amended by the Law of 23 December 2005 and the Law of 29 August 2017.

#### MALTA

- (a) Social Security Act (Att dwar is-Sigurta' Socjali) (Cap. 318)
- (b) Subsidiary Legislation 318.19: State-Owned Institutions and Hostels Rates Regulations (Regolamenti dwar it-Trasferiment ta' Fondi għal Hostels Statali Indikati)
- (c) Subsidiary Legislation 318.17: Transfer of Funds (Government Financed Beds) Regulations (Regolamenti dwar it-Trasferiment ta' Fondi għal Sodod Iffinanzjati mill-Gvern)
- (d) Subsidiary Legislation 318.13: State Financed Residential Services Rates Regulations (Regolamenti dwar Rati għal Servizzi Residenzjali Finanzjali mill-Istat).

#### THE NETHERLANDS

Long term care act (Wet langdurige zorg (WLZ)), Law of 3 December 2014.

#### POLAND

- (a) Law on Health Care Services financed from Public Means (Ustawa o świadczeniach opieki zdrowotnej finansowanych ze środków publicznych) of 27 August 2004
- (b) Law on Social Assistance (Ustawa o pomocy społecznej) of 12 March 2004
- (c) Law on Family Benefits (Ustawa o świadczeniach rodzinnych) of 28 November 2003
- (d) Law on Social Pension (Ustawa o rencie socjalnej) of 27 June 2003
- (e) Law on Social Insurance Fund Pensions (Ustawa o emeryturach i rentach z Funduszu Ubezpieczeń Społecznych) of 17 December 1998
- (f) Law on Vocational and Social Rehabilitation and Employment of Disabled Persons (Ustawa o rehabilitacji zawodowej i społecznej oraz zatrudnianiu osób niepełnosprawnych) of 27 August 1997
- (g) Law on support for pregnant women and their families "For life" (Ustawa o wsparciu kobiet w ciąży i rodzin "Za życiem") of 4 November 2016
- (h) Law on supplementary benefit for persons unable to live independently (Ustawa o świadczeniu uzupełniającym dla osób niezdolnych do samodzielnej egzystencji) of 31 July 2019

#### PORTUGAL

- (a) Social insurance and guaranteeing sufficient resources:

- (b) Statutory Decree 265/99 of 14 July 1999 on the long-term care supplement (complemento por dependência), as amended on several occasions
- (c) Act 90/2009 of 31 August 2009 on the special protection system in case of disability (regime especial de proteção na invalidez), re-published in consolidated version by Statutory Decree 246/2015 of 20 October 2015, amended
- (d) Social security system and National Health Service:
- (e) Statutory Decree 101/06 of 6 June 2006 on the National network of integrated continuing care (rede de cuidados continuados integrados), re-published in a consolidated version in Statutory Decree 136/2015 of 28 July 2015
- (f) Decree-Law n° 8/2010 of 28 January 2010, amended and republished by Decree-Law n° 22/2011 of 10 February 2011 on the creation of units and teams for integrated continuous care in mental health (unidades e equipas de cuidados continuados integrados de saúde mental)
- (g) Decree n° 343/.2015 of 12 October 2015 on standards governing hospital and ambulatory paediatric care as well as the discharge management teams and the paediatric care teams within the framework of the national network of long-term integrated care (condições de instalação e funcionamento das unidades de internamento de cuidados integrados pediátricos e de ambulatório pediátricos, bem como as condições a que devem obedecer as equipas de gestão de altas e as equipas de cuidados continuados integrados destinadas a cuidados pediátricos da Rede Nacional de Cuidados Continuados Integrados)
- (h) Law n° 6/2009 of 6 September on the status of informal carer (Estatuto do cuidador informal).

#### ROMANIA

- (a) Law 17 of 6 March 2000 on Social Assistance of Senior Persons (Legea privind asistenta sociala a persoanelor varstnice), with subsequent amendments
- (b) Law 448 of 6 December 2006 on Protection and Promotion of the Rights of Persons with Disability (Legea privind protectia si promovarea drepturilor persoanelor cu handicap), with subsequent amendments
- (c) Social Assistance Law (Legea asistentei sociale) No. 292 of 20 December 2011.

#### SLOVAKIA

- (a) Law on Social Services (Zákon o sociálnych službách) No. 448/2008
- (b) Law on Financial Benefits for Compensation of Disabled Persons (Zákon o peňažných príspevkoch na kompenzáciu ťažkého zdravotného postihnutia) No. 447/2008
- (c) Law on Health Care and Services Related to Health Care (Zákon o zdravotnej starostlivosti a službách súvisiacich s poskytovaním zdravotnej starostlivosti) No. 576/2004
- (d) Law on Health Care Providers, Medical Workers and Professional Medical Associations (Zákon o poskytovateľoch zdravotnej starostlivosti, zdravotníckych pracovníkoch a stavovských organizáciách v zdravotníctve) No. 578/2004
- (e) Law on Subsistence Minimum (Zákon o životnom minime) No. 601/2003

- (f) Law on Family (Zákon o rodine) No. 36/2005
- (g) Law on Social and legal protection of children and social guardianship (Zákon o sociálno-právnej ochrane detí a sociálnej kuratele) No. 305/2005
- (h) Law on Social Work (Zákon o sociálnej práci) No. 219/2014.

#### SLOVENIA

No specific law related to long-term care.

Long-term care benefits are included in the following acts:

- (a) Pension and Disability Insurance Act (Zakon o pokojninskem in invalidskem zavarovanju) (Official Gazette of the Republic of Slovenia, no. 96/2012, and subsequent amendments)
- (b) Financial Social Assistance Act (Zakon o socialno varstvenih prejemkih) (Official Gazette of the Republic of Slovenia, no. 61/2010, and subsequent amendments)
- (c) Exercise of Rights to Public Funds Act (Zakon o uveljavljanju pravic iz javnih sredstev) (Official Gazette of the Republic of Slovenia, no. 62/2010, and subsequent amendments)
- (d) Social Protection Act (Zakon o socialnem varstvu) (Official Gazette of the Republic of Slovenia, no. 3/2004 – official consolidated text, and subsequent amendments)
- (e) Parental Care and Family Benefits Act (Zakon o starševskem varstvu in družinskih prejemkih) (Official Gazette of the Republic of Slovenia, no. 110/2006 – official consolidated text, and subsequent amendments)
- (f) Mentally and Physically Handicapped Persons Act (Zakon o družbenem varstvu duševno in telesno prizadetih oseb) (Official Gazette of the Republic of Slovenia, no. 41/83, and subsequent amendments)
- (g) Health Care and Health Insurance Act (Zakon o zdravstvenem varstvu in zdravstvenem zavarovanju) (Official Gazette of the Republic of Slovenia, no. 72/2006 – official consolidated text, and subsequent amendments)
- (h) War Veterans Act (Zakon o vojnih veteranih) (Official Gazette of the Republic of Slovenia, no. 59/06 official consolidated text, and subsequent amendments)
- (i) War Disability Act (Zakon o vojnih invalidih) (Official Gazette of the Republic of Slovenia, no. 63/59 official consolidated text, and subsequent amendments)
- (j) Fiscal Balance Act (Zakon za uravnoteženje javnih finance (ZUJF)) (Official Gazette of the Republic of Slovenia, no. 40/2012, and subsequent amendments)
- (k) Act Regulating Adjustments of Transfers to Individuals and Households in the Republic of Slovenia (Zakon o usklajevanju transferjev posameznikom in gospodinjstvom v Republiki Sloveniji) (Official Gazette of the Republic of Slovenia, no. 114/2006 – official consolidated text, and subsequent amendments).

#### SPAIN

- (a) Law No. 39/2006 on the Promotion of Personal Autonomy and Assistance to persons in situations of dependence of 14 December 2006, as amended

- (b) Social Security General Act (Ley General de la Seguridad Social) approved by Legislative Royal Decree No. 8/2015 of 30 October 2015
- (c) Ministerial Order of 15 April 1969
- (d) Royal Decree No. 1300/95 of 21 July 1995, as amended
- (e) Royal Decree No. 1647/97 of 31 October 1997, as amended.

#### SWEDEN

- (a) Social Services Act (Socialtjänstlagen (2001:453)) of 2001
- (b) The Health Care Act (Hälsa- och sjukvårdslag (2017:30)) of 2017.

Part 3: Payments which are connected to a branch of social security listed in Article SSC.3(1) [Matters covered] of the Protocol and which are paid to meet expenses for heating in cold weather (point (f) of Article SSC.3(4)[Matters covered] of the Protocol).

#### (i) UNITED KINGDOM

Winter Fuel Payment (Social Security Contributions and Benefits Act 1992, Social Fund Winter Fuel Payment Regulations 2000, Social Security Contributions and Benefits (Northern Ireland) Act 1992 and Social Fund Winter Fuel Payment Regulations (Northern Ireland) 2000).

#### (iii) MEMBER STATES

#### DENMARK

- (a) Act on Social and state pensions, LBK no. 983 of 23/09/2019
- (b) Regulations on social and state pensions, BEK no. 1602 of 27/12/2019.



*ANNEX SSC-2: RESTRICTION OF RIGHTS TO BENEFITS IN KIND FOR MEMBERS OF THE FAMILY OF A FRONTIER WORKER*

(referred to in Article SSC.16(2)[Stay in the competent State when residence is in another State – special rules for the members of the families of frontier workers])

CROATIA

DENMARK

IRELAND

FINLAND

SWEDEN

UNITED KINGDOM

*ANNEX SSC-3: MORE RIGHTS FOR PENSIONERS RETURNING TO THE COMPETENT STATE*

(Article SSC.25(2)[Stay of the pensioner or the members of their family in a State other than the State of residence – stay in the competent State – authorisation for appropriate treatment outside the State of residence])

AUSTRIA

BELGIUM

BULGARIA

CYPRUS

CZECH REPUBLIC

FRANCE

GERMANY

GREECE

HUNGARY

LUXEMBOURG

THE NETHERLANDS

POLAND

SLOVENIA

SPAIN

SWEDEN

*ANNEX SSC-4: CASES IN WHICH THE PRO RATA CALCULATION SHALL BE WAIVED OR SHALL NOT APPLY*

(Articles SSC.47(4) and 47(5) [Award of benefits])

PART 1: CASES IN WHICH THE PRO RATA CALCULATION SHALL BE WAIVED PURSUANT TO ARTICLE SSC.47(4) [AWARD OF BENEFITS]

AUSTRIA

- (a) All applications for benefits under the Federal Act of 9 September 1955 on General Social Insurance – ASVG, the Federal Act of 11 October 1978 on social insurance for self-employed persons engaged in trade and commerce – GSVG, the Federal Act of 11 October 1978 on social insurance for self-employed farmers – BSVG and the Federal Act of 30 November 1978 on social insurance for the self-employed in the liberal professions (FSVG);
- (b) All applications for survivors' pensions based on a pension account pursuant to the General Pensions Act (APG) of 18 November 2004, with the exception of cases under Part 2;
- (c) All applications for survivors' pensions of the Austrian Provincial Chambers of Physicians (Landesärztekammer) based on basic provision (basic and any supplementary benefit, or basic pension);
- (d) All applications for survivors' support from the pension fund of the Austrian Chamber of Veterinary Surgeons;
- (e) All applications for benefits from widows and orphans pensions according to the statutes of the welfare institutions of the Austrian bar associations, Part A;
- (f) All applications for benefits under the Notary Insurance Act of 3 February 1972 – NVG 1972.

CYPRUS

All applications for old age, widow's and widower's pensions.

DENMARK

All applications for pensions referred to in the law on social pensions, except for pensions mentioned in [Annex SSC-5] [BENEFITS AND AGREEMENTS WHICH ALLOW THE APPLICATION OF ARTICLE SSC.49 [Overlapping of benefits of the same kind]]

IRELAND

All applications for state pension (transition), state pension (contributory), widow's (contributory) pension and widower's (contributory) pension.

LATVIA

- (a) All applications for survivor's pensions (Law on State pensions of 1 January 1996; Law on State funded pensions of 1 July 2001).

LITHUANIA

All applications for State social insurance survivor's pensions calculated on the basis of the basic amount of survivor's pension (Law on State Social Insurance Pensions).

#### NETHERLANDS

All applications for old-age pensions under the law on general old-age insurance (AOW).

#### POLAND

All applications for old-age under the defined benefits scheme and survivors' pensions, except for the cases where the totalised periods of insurance completed under the legislation of more than one country are equal to or longer than 20 years for women and 25 years for men but the national periods of insurance are inferior to these limits (and not less than 15 years for women and 20 years for men), and the calculation is made under Articles 27 and 28 of the Act of 17 December 1998 (O.J. 2015, item 748).

#### PORTUGAL

All applications for old-age and survivors' pension claims, except for the cases where the totalised periods of insurance completed under the legislation of more than one country are equal to or longer than 21 calendar years but the national periods of insurance are equal or inferior to 20 years, and the calculation is made under Articles 32 and 33 of Decree-Law No 187/2007 of 10 May 2007.

#### SLOVAKIA

- (a) All applications for survivors' pension (widow's pension, widower's and orphan's pension) calculated according to the legislation in force before 1 January 2004, the amount of which is derived from a pension formerly paid to the deceased;
- (b) All applications for pensions calculated pursuant to Act No 461/2003 Coll. on social security as amended.

#### SWEDEN

- (a) Applications for an old-age pension in the form of a guaranteed pension (Chapters 66 and 67 of the Social Insurance Code).
- (b) Applications for an old-age pension in the form of a supplementary pension (Chapter 63 of the Social Insurance Code).

#### UNITED KINGDOM

All applications for retirement pension, state pension pursuant to Part 1 of the Pensions Act 2014, widows' and bereavement benefits, with the exception of those for which during a tax year beginning on or after 6 April 1975:

- (i) the party concerned had completed periods of insurance, employment or residence under the legislation of the United Kingdom and a Member State; and one (or more) of the tax years was not considered a qualifying year within the meaning of the legislation of the United Kingdom;
- (ii) the periods of insurance completed under the legislation in force in the United Kingdom for the periods prior to 5 July 1948 would be taken into account for the

purposes of point (b) of Article SSC.47(1) of the Protocol by application of the periods of insurance, employment or residence under the legislation of a Member State.

All applications for additional pension pursuant to the Social Security Contributions and Benefits Act 1992, section 44, and the Social Security Contributions and Benefits (Northern Ireland) Act 1992, section 44.

#### PART 2: CASES IN WHICH ARTICLE SSC.47(5) [AWARD OF BENEFITS] APPLIES

##### AUSTRIA

- (a) Old-age pensions and survivor's pensions derived thereof based on a pension account pursuant to the General Pensions Act (APG) of 18 November 2004;
- (b) Compulsory allowances under Article 41 of the Federal Law of 28 December 2001, BGBl I Nr. 154 on the general salary fund of Austrian pharmacists (Pharmazeutische Gehaltskasse für Österreich);
- (c) Retirement and early retirement pensions of the Austrian Provincial Chambers of Physicians based on basic provision (basic and any supplementary benefit, or basic pension), and all pension benefits of the Austrian Provincial Chambers of Physicians based on additional provision (additional or individual pension);
- (d) Old-age support from the pension fund of the Austrian Chamber of Veterinary Surgeons;
- (e) Benefits according to the statutes of the welfare institutions of the Austrian bar associations, Parts A and B, with the exception of applications for benefits from widows' and orphans' pensions according to the statutes of the welfare institutions of the Austrian bar associations, Part A;
- (f) Benefits by the welfare institutions of the Federal Chamber of Architects and Consulting Engineers under the Austrian Civil Engineers' Chamber Act (Ziviltechnikerkammergesetz) 1993 and the statutes of the welfare institutions, with the exception of benefits on grounds of survivors' benefits deriving from the last-named benefits;
- (g) Benefits according to the statute of the welfare institution of the Federal Chamber of Professional Accountants and Tax Advisors under the Austrian Professional Accountants and Tax Advisors' Act (Wirtschaftstreuhandberufsgesetz).

##### BULGARIA

Old age pensions from the Supplementary Compulsory Pension Insurance, under Part II, Title II, of the Social Insurance Code.

##### CROATIA

Pensions from the compulsory insurance scheme based on the individual capitalised savings according to the Compulsory and Voluntary Pension Funds Act (OG 49/99, as amended) and the Act on Pension Insurance Companies and Payment of Pensions Based on Individual Capitalised Savings (OG 106/99, as amended), except in the cases provided by Articles 47 and 48 of the Compulsory and Voluntary Pension Funds Act and survivor's pension).

##### CZECH REPUBLIC

Pensions paid from the Second Pillar scheme established by Act No 426/2011 Coll., on pension savings.

#### DENMARK

- (a) Personal pensions;
- (b) Benefits in the event of death (accrued based on contributions to Arbejdsmarkedets Tillægspension related to the time before 1 January 2002);
- (c) Benefits in the event of death (accrued based on contributions to Arbejdsmarkedets Tillægspension related to the time after 1 January 2002) referred to in the Consolidated Act on Labour Market Supplementary Pension (Arbejdsmarkedets Tillægspension) 942:2009.

#### ESTONIA

Mandatory funded old-age pension scheme.

#### FRANCE

Basic or supplementary schemes in which old-age benefits are calculated on the basis of retirement points.

#### HUNGARY

Pension benefits based on membership of private pension funds.

#### LATVIA

Old-age pensions (Law on State pensions of 1 January 1996; Law on State funded pensions of 1 July 2001).

#### POLAND

Old-age pensions under the defined contribution scheme.

#### PORTUGAL

Supplementary pensions granted pursuant to Decree-Law No 26/2008 of 22 February 2008 (public capitalisation scheme).

#### SLOVAKIA

Mandatory old-age pension saving.

#### SLOVENIA

Pension from compulsory supplementary pension insurance.

#### SWEDEN

Old-age pension in the form of an income pension and a premium pension (Chapters 62 and 64 of the Social Insurance Code).

## UNITED KINGDOM

Graduated retirement benefits paid pursuant to the National Insurance Act 1965, sections 36 and 37, and the National Insurance Act (Northern Ireland) 1966, sections 35 and 36.

*ANNEX SSC-5: BENEFITS AND AGREEMENTS WHICH ALLOW THE APPLICATION OF ARTICLE SSC.49  
[Overlapping of benefits of the same kind]*

I. Benefits referred to in point (a) of Article SSC.49(2) [Overlapping of benefits of the same kind] of the Protocol, the amount of which is independent of the length of periods of insurance or residence completed

DENMARK

The full Danish national old-age pension acquired after 10 years' residence by persons who will have been awarded a pension by 1 October 1989

FINLAND

National pensions and spouse's pensions determined according to the transitional rules and awarded prior to the 1 of January 1994 (Act on Enforcement of the National Pensions Act, 569/2007)

The additional amount of child's pension when calculating independent benefit according to the National Pension Act (the National Pension Act, 568/2007)

FRANCE

Widower's or widow's invalidity pension under the general social security system or under the agricultural workers scheme where it is calculated on the basis of the deceased spouse's invalidity pension settled in accordance with point (a) of Article SSC.47(1) [Award of benefits].

GREECE

Benefits under Law No 4169/1961 relating to the agricultural insurance scheme (OGA)

NETHERLANDS

General Surviving Relatives Act of 21 December 1995 (ANW)

The Work and Income according to Labour Capacity Act of 10 November 2005 (WIA)

SPAIN

Survivors' pensions granted under the general and special schemes, with the exception of the Special Scheme for Civil Servants

SWEDEN

Income-related sickness compensation and income-related activity compensation (Chapter 34 of the Social Insurance Code)

Guaranteed pension and guaranteed compensation which replaced the full state pensions provided under the legislation on the state pension which applied before 1 January 1993, and the full state pension awarded under the transitional rules of the legislation applying from that date



II. Benefits referred to in point (b) of Article SSC.49(2) [Overlapping of benefits of the same kind] of the Protocol, the amount of which is determined by reference to a credited period deemed to have been completed between the date on which the risk materialised and a later date

#### FINLAND

Employment pensions for which account is taken of future periods according to the national legislation

#### GERMANY

Survivors' pensions, for which account is taken of a supplementary period

Old-age pensions, for which account is taken of a supplementary period already acquired

#### ITALY

Italian pensions for total incapacity for work (inabilità)

#### LATVIA

Survivors' pension calculated on the basis of assumed insurance periods (Article 23(8) of the Law on State Pensions of 1 January 1996)

#### LITHUANIA

- (a) State social insurance work incapacity pensions, paid under the Law on State Social Insurance Pensions
- (b) State social insurance survivors' and orphans' pensions, calculated on the basis of the work incapacity pension of the deceased under the Law on State Social Insurance Pensions

#### LUXEMBOURG

Survivors' pensions

#### SLOVAKIA

Slovak survivors' pension derived from the invalidity pension.

#### SPAIN

The pensions for retirement under the Special Scheme for Civil Servants due under Title I of the consolidated text of the Law on State Pensioners if at the time of materialisation of the risk the beneficiary was an active civil servant or treated as such; death and survivors' (widows'/widowers', orphans' and parents') pensions due under Title I of the consolidated text of the Law on State Pensioners if at the time of death the civil servant was active or treated as such

#### SWEDEN

Sickness compensation and activity compensation in the form of guarantee compensation (Chapter 35 of the Social Insurance Code)

Survivors' pension calculated on the basis of credited insurance periods (Chapters 76-85 of the Social Insurance Code)

III. Agreements referred to in point (b)(i) of Article SSC.49(2) [Overlapping of benefits of the same kind]of the Protocol intended to prevent the same credited period being taken into account two or more times:

The Social Security Agreement of 28 April 1997 between the Republic of Finland and the Federal Republic of Germany

The Social Security Agreement of 10 November 2000 between the Republic of Finland and the Grand Duchy of Luxembourg

Nordic Convention on social security of 18 August 2003.

*ANNEX SSC-6: SPECIAL PROVISIONS FOR THE APPLICATION OF THE LEGISLATION OF THE MEMBER STATES AND OF THE UNITED KINGDOM*

(Articles SSC.3(2)[Matters covered], SSC.51(1)[Additional provisions for the calculation of benefits] and SSC.66 [Implementation of legislation])

AUSTRIA

1. For the purpose of acquiring periods in the pension insurance, attendance at a school or comparable educational establishment in another State shall be regarded as equivalent to attendance at a school or educational establishment pursuant to Articles 227(1)(1) and 228(1)(3) of the Allgemeines Sozialversicherungsgesetz (ASVG) (General Social Security Act), Article 116(7) of the Gewerbliches Sozialversicherungsgesetz (GSVG) (Federal Act on Social Insurance for Persons engaged in Trade and Commerce) and Article 107(7) of the Bauern-Sozialversicherungsgesetz (BSVG) (Social Security Act for Farmers), when the person concerned was subject at some time to Austrian legislation on the grounds that he pursued an activity as an employed or self-employed person, and the special contributions provided for under Article 227(3) of the ASVG, Article 116(9) of the GSVG and Article 107(9) of the BSVG for the purchase of such periods of education, are paid.

2. For the calculation of the pro rata benefit referred to in point (b) of Article SSC.47(1) [Award of benefits], special increments for contributions for supplementary insurance and the miners' supplementary benefit under Austrian legislation shall be disregarded. In those cases the pro rata benefit calculated without those contributions shall, if appropriate, be increased by unreduced special increments for contributions for supplementary insurance and the miners' supplementary benefit.

3. Where pursuant to Article SSC.7 [Aggregation of periods] of the Protocol substitute periods under an Austrian pension insurance scheme have been completed but cannot form a basis for calculation pursuant to Articles 238 and 239 of the ASVG, Articles 122 and 123 of the GSVG and Articles 113 and 114 of the BSVG, the calculation basis for periods of childcare pursuant to Article 239 of the ASVG, Article 123 of the GSVG and Article 114 of the BSVG shall be used.

BULGARIA

Article 33(1) of the Bulgarian Health Insurance Act applies to all persons for whom Bulgaria is the competent Member State under Chapter 1 [Sickness, maternity and equivalent paternity benefits] of Title III [Special provisions concerning the various categories of benefits] of the Protocol.

CYPRUS

For the purpose of applying the provisions of Articles SSC.7 [Aggregation of periods], SSC.46 [Special provisions on aggregation of periods] and SSC.56 [Special provisions on aggregation of periods of insurance, employment or self-employment], for any period commencing on or after 6 October 1980, a week of insurance under the legislation of the Republic of Cyprus is determined by dividing the total insurable earnings for the relevant period by the weekly amount of the basic insurable earnings applicable in the relevant contribution year, provided that the number of weeks so determined shall not exceed the number of calendar weeks in the relevant period.

CZECH REPUBLIC

For the purposes of defining members of the family in accordance with point (s) of Article SSC.1 [Definitions] of the Protocol, 'spouse' includes registered partners as defined in the Czech act no. 115/2006 Coll., on registered partnership.

#### DENMARK

#### 1.

- (a) For the purpose of calculating the pension under the 'lov om social pension' (Social Pension Act), periods of activity as an employed or self-employed person completed under Danish legislation by a frontier worker or a worker who has gone to Denmark to do work of a seasonal nature are regarded as periods of residence completed in Denmark by the surviving spouse in so far as, during those periods, the surviving spouse was linked to the abovementioned worker by marriage without separation from bed and board or de facto separation on grounds of incompatibility, and provided that, during those periods, the spouse resided in the territory of another State. For the purposes of this point, 'work of a seasonal nature' means work which, being dependent on the succession of the seasons, automatically recurs each year.
- (b) For the purpose of calculating the pension under the 'lov om social pension' (Social Pension Act), periods of activity as an employed or self-employed person completed under Danish legislation before 1 January 1984 by a person to whom point (a) does not apply shall be regarded as periods of residence completed in Denmark by the surviving spouse, in so far as, during those periods, the surviving spouse was linked to that person by marriage without separation from bed and board or de facto separation on grounds of incompatibility, and provided that, during those periods, the spouse resided in the territory of another State.
- (c) Periods to be taken into account under points (a) and (b) shall not be taken into consideration if they coincide with the periods taken into account for the calculation of the pension due to the person concerned under the legislation on compulsory insurance of another State, or with the periods during which the person concerned received a pension under such legislation. Those periods shall, however, be taken into consideration if the annual amount of the said pension is less than half the basic amount of the social pension.

#### 2.

- (a) Notwithstanding the provisions of Article SSC.7 [Aggregation of periods] of the Protocol, persons who have not been gainfully employed in one or more States are entitled to a Danish social pension only if they have been, or have previously been, permanent residents of Denmark for at least 3 years, subject to the age limits prescribed by Danish legislation. Subject to Article SSC.5 [Equality of treatment] of the Protocol, Article SSC.8 [Waiving of residence rules] of the Protocol does not apply to a Danish social pension to which entitlement has been acquired by such persons.
- (b) The provisions referred to in point (a) do not apply to Danish social pension entitlement for the members of the family of persons who are or have been gainfully employed in Denmark, or for students or the members of their families.

3. The temporary benefit for unemployed persons who have been admitted to the ledighedsydelse (flexible job' scheme) (Law No 455 of 10 June 1997) is covered by Chapter 6

[Unemployment Benefits] of Title III [Special provisions concerning the various categories of benefits] of the Protocol.

4. Where the beneficiary of a Danish social pension is also entitled to a survivor's pension from another State, those pensions for the implementation of Danish legislation shall be regarded as benefits of the same kind within the meaning of Article SSC.48(1) [Rules to prevent overlapping], subject to the condition, however, that the person whose periods of insurance or of residence serve as the basis for the calculation of the survivor's pension had also acquired a right to a Danish social pension.

#### ESTONIA

For the purpose of calculating parental benefits, periods of employment in States other than Estonia shall be considered to be based on the same average amount of Social Tax as paid during the periods of employment in Estonia with which they are aggregated. If during the reference year the person has been employed only in other States, the calculation of the benefit shall be considered to be based on the average Social Tax paid in Estonia between the reference year and the maternity leave.

1. For the purposes of determining entitlement and of calculating the amount of the Finnish national pension under Articles SSC.47 [Award of benefits] to 49 [Overlapping of benefits of the same kind], pensions acquired under the legislation of another State are treated in the same way as pensions acquired under Finnish legislation.

2. When applying point (b)(i) of Article SSC.47(1) [Award of benefits] for the purpose of calculating earnings for the credited period under Finnish legislation on earnings-related pensions, where an individual has pension insurance periods based on activity as an employed or self-employed person in another State for part of the reference period under Finnish legislation, the earnings for the credited period shall be equivalent to the sum of earnings obtained during the part of the reference period in Finland, divided by the number of months for which there were insurance periods in Finland during the reference period.

#### FRANCE

1. For persons receiving benefits in kind in France pursuant to Articles SSC.15 [Residence in a State other than the competent State], SSC.24 [Residence of members of the family in a State other than the one in which the pensioner resides] of the Protocol who are resident in the French departments of Haut-Rhin, Bas-Rhin or Moselle, benefits in kind provided on behalf of the institution of another State which is responsible for bearing their cost include benefits provided by both the general sickness insurance scheme and the obligatory supplementary local sickness insurance scheme of Alsace-Moselle.

2. French legislation applicable to a person engaged, or formerly engaged, in an activity as an employed or self-employed person for the application of Chapter 5 [Old-age and survivors' pensions] of Title III [Special provisions concerning the various categories of benefits] includes both the basic old-age insurance scheme(s) and the supplementary retirement scheme(s) to which the person concerned was subject.

#### GERMANY

1. Notwithstanding point (a) of Article SSC.6 [Equal treatment of benefits, income, facts or events] of the Protocol and Article 5(4) point 1 of the Sozialgesetzbuch VI (Volume VI of the Social

Code), a person who receives a full old-age pension under the legislation of another State may request to be compulsorily insured under the German pension insurance scheme.

2. Notwithstanding point (a) of Article SSC.6 [Equal treatment of benefits, income, facts or events] of the Protocol and Article 7 of the Sozialgesetzbuch VI (Volume VI of the Social Code), a person who is compulsorily insured in another State, or receives an old-age pension under the legislation of another State may join the voluntary insurance scheme in Germany.

3. For the purpose of granting cash benefits under §47(1) of SGB V, §47(1) of SGB VII and §200(2) of the Reichsversicherungsordnung to insured persons who live in another State, German insurance schemes calculate net pay, which is used to assess benefits, as if the insured person lived in Germany, unless the insured person requests an assessment on the basis of the net pay which he actually receives.

4. Nationals of other States whose place of residence or usual abode is outside Germany and who fulfil the general conditions of the German pension insurance scheme may pay voluntary contributions only if they had been voluntarily or compulsorily insured in the German pension insurance scheme at some time previously; this also applies to stateless persons and refugees whose place of residence or usual abode is in another State.

5. The pauschale Anrechnungszeit (fixed credit period) pursuant to Article 253 of the Sozialgesetzbuch VI (Volume VI of the Social Code) shall be determined exclusively with reference to German periods.

6. In cases where the German pension legislation, in force on 31 December 1991, is applicable for the recalculation of a pension, only the German legislation applies for the purposes of crediting German Ersatzzeiten (substitute periods).

7. The German legislation on accidents at work and occupational diseases to be compensated for under the law governing foreign pensions and on benefits for insurance periods which can be credited under the law governing foreign pensions in the territories named in paragraph 1(2)(3) of the Act on affairs of displaced persons and refugees (Bundesvertriebenengesetz) continues to apply within the scope of application of the Protocol, notwithstanding the provisions of paragraph 2 of the Act on foreign pensions (Fremdrentengesetz).

8. For the calculation of the theoretical amount referred to in point (b)(i) of Article SSC.47(1) [Award of benefits], in pension schemes for liberal professions, the competent institution shall take as a basis, in respect of each of the years of insurance completed under the legislation of any other State, the average annual pension entitlement acquired during the period of membership of the competent institution through the payment of contributions.

## GREECE

1. Law No 1469/84 concerning voluntary affiliation to the pension insurance scheme for Greek nationals and foreign nationals of Greek origin is applicable to nationals of other States, stateless persons and refugees, where the persons concerned, regardless of their place of residence or stay, have at some time in the past been compulsorily or voluntarily affiliated to the Greek pension insurance scheme.

2. Notwithstanding point (a) of Article SSC.6 [Equal treatment of benefits, income, facts or events] of the Protocol and Article 34 of Law 1140/1981, a person who receives a pension in respect of accidents at work or occupational diseases under the legislation of another State may request to

be compulsorily insured under the legislation applied by OGA, to the extent that they pursue an activity falling within the scope of that legislation.

#### IRELAND

1. Notwithstanding Articles SSC.19(2) [Cash benefits] and SSC.57 [Calculation of unemployment benefits], for the purposes of calculating the prescribed reckonable weekly earnings of an insured person for the grant of sickness or unemployment benefit under Irish legislation, an amount equal to the average weekly wage of employed persons in the relevant prescribed year shall be credited to that insured person in respect of each week of activity as an employed person under the legislation of another State during that prescribed year.

#### MALTA

##### Special provisions for civil servants

- (a) Solely for the purposes of the application of Articles SSC.43 [Special provisions for civil servants] and SSC.55 [Special provisions for civil servants] of the Protocol, persons employed under the Malta Armed Forces Act (Chapter 220 of the Laws of Malta), the Police Act (Chapter 164 of the Laws of Malta) and the Prisons Act (Chapter 260 of the Laws of Malta) shall be treated as civil servants;
- (b) Pensions payable under the above Acts and under the Pensions Ordinance (Chapter 93 of the Laws of Malta) shall, solely for the purposes of point (cc) of Article SSC.1 [Definitions] of the Protocol, be considered as 'special schemes for civil servants'.

#### NETHERLANDS

##### 1. Health care insurance

- (a) As regards entitlement to benefits in kind under Dutch legislation, persons entitled to benefits in kind for the purpose of the implementation of Chapters 1 [Sickness, maternity and equivalent paternity benefits] and 2 [Benefits in respect of accidents at work and occupational diseases] of Title III of the Protocol shall mean:
  - (i) persons who, under Article 2 of the Zorgverzekeringswet (Health Care Insurance Act), are obliged to take out insurance under a health care insurer; and
  - (ii) in so far as they are not already included under point (i), members of the family of active military personnel who are living in another State and persons who are resident in another State and who, under the Protocol, are entitled to health care in their state of residence, the costs being borne by the Netherlands.
- (b) The persons referred to in point 1(a)(i) must, in accordance with the provisions of the Zorgverzekeringswet (Health Care Insurance Act), take out insurance with a health care insurer, and the persons referred to in point 1(a)(ii) must register with the College voor zorgverzekeringen (Health Care Insurance Board);
- (c) The provisions of the Zorgverzekeringswet (Health Care Insurance Act) and the Algemene Wet Bijzondere Ziektekosten (General Act on Exceptional Medical Expenses) concerning liability for the payment of contributions shall apply to the persons referred to in point (a) and the members of their families. In respect of members of the family, the contributions shall be

levied on the person from whom the right to health care is derived with the exception of the members of the family of military personnel living in another State, who shall be levied directly;

- (d) The provisions of the Zorgverzekeringswet (Health Care Insurance Act) concerning late insurance shall apply *mutatis mutandis* in the event of late registration with the College voor zorgverzekeringen (Health Care Insurance Board) in respect of the persons referred to in point (a)(ii).;
- (e) Persons entitled to benefits in kind by virtue of the legislation of a State other than the Netherlands who reside in the Netherlands or stay temporarily in the Netherlands shall be entitled to benefits in kind in accordance with the policy offered to insured persons in the Netherlands by the institution of the place of residence or the place of stay, taking into account Article 11(1), (2) and (3) and Article 19(1) of the Zorgverzekeringswet (Health Care Insurance Act), as well as to benefits in kind provided for by the Algemene Wet Bijzondere Ziektekosten (General Act on Exceptional Medical Expenses);
- (f) For the purposes of Articles SSC.21 [Right to benefits in kind under the legislation of the State of residence] to SSC.27 [Contributions by pensioners] of the Protocol, the following benefits (in addition to pensions covered by Chapters 4 [Invalidity benefits] and 5 [Old-age and survivors' pensions] of Title III [Special provisions concerning the various categories of benefits] of the Protocol shall be treated as pensions due under Dutch legislation:
- pensions awarded under the Law of 6 January 1966 on pensions for civil servants and their survivors (Algemene burgerlijke pensioenwet) (Netherlands Civil Service Pensions Act),
  - pensions awarded under the Law of 6 October 1966 on pensions for military personnel and their survivors (Algemene militaire pensioenwet) (Military Pensions Act),
  - benefits for incapacity for work awarded under the Law of 7 June 1972 on benefits for incapacity for work for military personnel (Wetarbeidsongeschiktheidsvoorziening militairen) (Military Personnel Incapacity for Work Act),
  - pensions awarded under the Law of 15 February 1967 on pensions for employees of the NV Nederlandse Spoorwegen (Dutch Railway Company) and their survivors (Spoorwegpensioenwet) (Railway Pensions Act),
  - pensions awarded under the Reglement Dienstvoorwaarden Nederlandse Spoorwegen (governing conditions of employment of the Netherlands Railway Company),
  - benefits awarded to retired persons before reaching the pensionable age of 65 years under a pension designed to provide income for former employed persons in their old age, or benefits provided in the event of premature exit from the labour market under a scheme set up by the state or by an industrial agreement for persons aged 55 or over,



- benefits awarded to military personnel and civil servants under a scheme applicable in the event of redundancy, superannuation and early retirement.
- (g) For the purposes of Article SSC.16(1) [Stay in the competent State when residence is in another State – special rules for the members of the families of frontier workers] of the Protocol, the persons referred to in point (a)(ii) of this paragraph who stay temporarily in the Netherlands shall be entitled to benefits in kind in accordance with the policy offered to insured persons in the Netherlands by the institution of the place of stay, taking into account Article 11(1), (2) and (3) and Article 19(1) of the Zorgverzekeringswet (Health Care Insurance Act), as well as to benefits in kind provided for by the Algemene Wet Bijzondere Ziektekosten (General Act on Exceptional Medical Expenses).

2. Application of the Algemene Ouderdomswet (AOW) (General Old Age Pensions Act)

- (a) The reduction referred to in Article 13(1) of the AOW (General Old Age Pensions Act) shall not be applied for calendar years before 1 January 1957 during which a recipient not satisfying the conditions for having such years treated as periods of insurance:
- resided in the Netherlands between the ages of 15 and 65,
  - while residing in another State, worked in the Netherlands for an employer established in the Netherlands, or
  - worked in another State during periods regarded as periods of insurance under the Dutch social security system.

By way of derogation from Article 7 of the AOW, anyone who resided or worked in the Netherlands in accordance with the above conditions only prior to 1 January 1957 shall also be regarded as being entitled to a pension.

- (b) The reduction referred to in Article 13(1) of the AOW shall not apply to calendar years prior to 2 August 1989 during which a person, between the ages of 15 and 65, who is or was married was not insured under the above legislation, while being resident in the territory of a State other than the Netherlands, if these calendar years coincide with periods of insurance completed by the person's spouse under the above legislation or with calendar years to be taken into account under point (a) of this paragraph, provided that the couple's marriage subsisted during that time.

By way of derogation from Article 7 of the AOW, such a person shall be regarded as being entitled to a pension.

- (c) The reduction referred to in Article 13(2) of the AOW shall not apply to calendar years before 1 January 1957 during which a pensioner's spouse who fails to satisfy the conditions for having such years treated as periods of insurance:
- resided in the Netherlands between the ages of 15 and 65, or
  - while residing in another State, worked in the Netherlands for an employer established in the Netherlands, or

- worked in another State during periods regarded as periods of insurance under the Netherlands social security system.
- (d) The reduction referred to in Article 13(2) of the AOW shall not apply to calendar years prior to 2 August 1989 during which a pensioner's spouse resident in a State other than the Netherlands, between the ages of 15 and 65, was not insured under the AOW, if those calendar years coincide with periods of insurance completed by the pensioner under that legislation or with calendar years to be taken into account under point (a) of this paragraph, provided that the couple's marriage subsisted during that time.
- (e) Points 2(a), 2(b), 2(c) and 2(d) shall not apply to periods which coincide with:
- periods which may be taken into account for calculating pension rights under the old-age insurance legislation of a State other than the Netherlands, or
  - periods for which the person concerned has drawn an old-age pension under such legislation.

Periods of voluntary insurance under the system of another State shall not be taken into account for the purposes of this point.

- (f) Points 2(a), 2(b), 2(c) and 2(d) shall apply only if the person concerned has resided in one or more States for 6 years after the age of 59 and only for such time as that person is resident in one of those States.
- (g) By way of derogation from Chapter IV of the AOW, anyone resident in a State other than the Netherlands whose spouse is covered by compulsory insurance under that legislation shall be authorised to take out voluntary insurance under that legislation for periods during which the spouse is compulsorily insured.

This authorisation shall not cease where the spouse's compulsory insurance is terminated as a result of their death and where the survivor receives only a pension under the Algemene nabestaandenwet (General Surviving Relatives Act).

In any event, the authorisation in respect of voluntary insurance ceases on the date on which the person reaches the age of 65.

The contribution to be paid for voluntary insurance shall be set in accordance with the provisions relating to the determination of the contribution for voluntary insurance under the AOW. However, if the voluntary insurance follows on from a period of insurance as referred to in point 2(b), the contribution shall be set in accordance with the provisions relating to the determination of the contribution for compulsory insurance under the AOW, with the income to be taken into account being deemed to have been received in the Netherlands.

- (h) The authorisation referred to in point 2(g) shall not be granted to anyone insured under another State's legislation on pensions or survivors' benefits;
- (i) Anyone wishing to take out voluntary insurance under point 2(g) shall be required to apply for it to the Social Insurance Bank (Sociale Verzekeringsbank) not later than 1 year after the date on which the conditions for participation are fulfilled.

3. Application of the Algemene nabestaandenwet (ANW) (General Surviving Relatives Act)
- (a) Where the surviving spouse is entitled to a survivor's pension under the ANW (General Surviving Relatives Act) pursuant to Article SSC.46(3) [Special provisions on aggregation of periods] of the Protocol, that pension shall be calculated in accordance with point (1)(b) of Article SSC.47 [Award of benefits] of the Protocol.

For the application of these provisions, periods of insurance prior to 1 October 1959 shall also be regarded as periods of insurance completed under Dutch legislation if during those periods the insured person, after the age of 15:

- resided in the Netherlands, or
  - while resident in another State, worked in the Netherlands for an employer established in the Netherlands, or
  - worked in another State during periods regarded as periods of insurance under the Dutch social security system.
- (b) Account shall not be taken of the periods to be taken into consideration under point 3(a) which coincide with periods of compulsory insurance completed under the legislation of another State in respect of survivor's pensions;
- (c) For the purposes of point (b) of Article SSC.47(1) [Award of benefits] of the Protocol, only periods of insurance completed under Dutch legislation after the age of 15 shall be taken into account as periods of insurance;
- (d) By way of derogation from Article 63a(1) of the ANW, a person resident in a State other than the Netherlands whose spouse is compulsorily insured under the ANW shall be authorised to take out voluntary insurance under the ANW provided that such insurance has already begun by the date of application of the Protocol, but only for periods during which the spouse is compulsorily insured;

That authorisation shall cease as from the date of termination of the spouse's compulsory insurance under the ANW, unless the spouse's compulsory insurance is terminated as a result of their death and where the survivor only receives a pension under the ANW.

In any event, the authorisation in respect of voluntary insurance ceases on the date on which the person reaches the age of 65.

The contribution to be paid for voluntary insurance shall be set in accordance with the provisions relating to the determination of contributions for voluntary insurance under the ANW. However, if the voluntary insurance follows on from a period of insurance as referred to in point 2(b), the contribution shall be set in accordance with the provisions relating to the determination of contributions for compulsory insurance under the ANW, with the income to be taken into account being deemed to have been received in the Netherlands.

4. Application of Dutch legislation relating to incapacity for work

In calculating benefits under either the WAO, WIA or the WAZ, the Netherlands institutions shall take account of:

- periods of paid employment, and periods treated as such, completed in the Netherlands before 1 July 1967,
- periods of insurance completed under the WAO,
- periods of insurance completed by the person concerned, after the age of 15, under the Algemene Arbeidsongeschiktheidswet (General Act on Incapacity for Work), in so far as they do not coincide with the periods of insurance completed under the WAO,
- periods of insurance completed under the WAZ,
- periods of insurance completed under the WIA.

## SPAIN

1. For the purpose of implementing point (1)(b) of Article SSC.47(1) [Award of benefits] of the Protocol, the years which the worker lacks to reach the pensionable or compulsory retirement age as stipulated under Article 31(4) of the consolidated version of the Ley de Clases Pasivas del Estado (Law on State Pensioners) shall be taken into account as actual years of service to the State only if at the time of the event in respect of which death pensions are due, the beneficiary was covered by Spain's special scheme for civil servants or was performing an activity assimilated under the scheme, or if, at the time of the event in respect of which the pensions are due, the beneficiary was performing an activity that would have required the person concerned to be included under the State's special scheme for civil servants, the armed forces or the judiciary, had the activity been performed in Spain.

2.

- (a) Under point (1)(c) of Article SSC.51 [Additional provisions for the calculation of benefits], the calculation of the theoretical Spanish benefit shall be carried out on the basis of the actual contributions of the person during the years immediately preceding payment of the last contribution to Spanish social security. Where, in the calculation of the basic amount for the pension, periods of insurance or residence under the legislation of other States have to be taken into account, the contribution basis in Spain which is closest in time to the reference periods shall be used for those periods, taking into account the development of the retail price index.
- (b) The amount of the pension obtained shall be increased by the amount of the increases and revaluations calculated for each subsequent year for pensions of the same nature.

3. Periods completed in other States which must be calculated in the special scheme for civil servants, the armed forces and the judicial administration, will be treated in the same way, for the purposes of Article SSC.51 [Additional provisions for the calculation of benefits], as the periods closest in time covered as a civil servant in Spain.

4. The additional amounts based on age referred to in the Second Transitional Provision of the General Law on Social Security shall be applicable to all beneficiaries under the Protocol who have

contributions to their name under the Spanish legislation prior to 1 January 1967; it shall not be possible, by application of Article SSC.6 [Equal treatment of benefits, income, facts or events] of the Protocol, to treat periods of insurance credited in another State prior to 1 January 1967 as being the same as contributions paid in Spain, solely for the purposes of the Protocol. The date corresponding to 1 January 1967 shall be 1 August 1970 for the Special Scheme for Seafarers and 1 April 1969 for the Special Social Security Scheme for Coal Mining.

#### SWEDEN

1. The provisions of the Protocol on the aggregation of insurance periods and periods of residence shall not apply to the transitional provisions in the Swedish legislation on entitlement to guarantee pension for persons born in or before 1937 who have been resident in Sweden for a specified period before applying for a pension (Act 2000:798).

2. For the purpose of calculating income for notional income-related sickness compensation and income-related activity compensation in accordance with Chapter 8 of the Lag (1962:381) om allmän försäkring (the National Insurance Act), the following shall apply:

(a) where the insured person, during the reference period, has also been subject to the legislation of one or more other States on account of activity as an employed or self-employed person, income in the State(s) concerned shall be deemed to be equivalent to the insured person's average gross income in Sweden during the part of the reference period in Sweden, calculated by dividing the earnings in Sweden by the number of years over which those earnings accrued;

3.

(a) For the purpose of calculating notional pension assets for income-based survivor's pension (Act 2000:461), if the requirement in Swedish legislation for pension entitlement in respect of at least three out of the 5 calendar years immediately preceding the insured person's death (reference period) is not met, account shall also be taken of insurance periods completed in other States as if they had been completed in Sweden. Insurance periods in other States shall be regarded as based on the average Swedish pension base. If the person concerned has only 1 year in Sweden with a pension base, each insurance period in another State shall be regarded as constituting the same amount.

(b) For the purpose of calculating notional pension credits for widows' pensions relating to deaths on or after 1 January 2003, if the requirement in Swedish legislation for pension credits in respect of at least two out of the 4 years immediately preceding the insured person's death (reference period) is not met and insurance periods were completed in another State during the reference period, those years shall be regarded as being based on the same pension credits as the Swedish year.

#### UNITED KINGDOM

1. Where, in accordance with United Kingdom legislation, a person may be entitled to a retirement pension if:

(a) the contributions of a former spouse are taken into account as if they were that person's own contributions; or

(b) the relevant contribution conditions are satisfied by that person's spouse or former spouse, then provided, in each case, that the spouse or former spouse is or had been exercising an activity as an employed or self-employed person, and had been subject to the legislation of two or more States, the provisions of Chapter 5 [Old-age and survivors' pensions] of Title III [Special provisions concerning the various categories of benefits] of the Protocol shall apply in order to determine entitlement under United Kingdom legislation. In that case, references in Chapter 5 [Old-age and survivors' pensions] of Title III [Special provisions concerning the various categories of benefits] of the Protocol to 'periods of insurance' shall be construed as references to periods of insurance completed by:

(i) a spouse or former spouse where a claim is made by:

- a married woman, or
- a person whose marriage has terminated otherwise than by the death of the spouse; or

(ii) a former spouse, where a claim is made by:

- a widower who immediately before pensionable age is not entitled to a widowed parent's allowance, or
- a widow who immediately before pensionable age is not entitled to a widowed mother's allowance, widowed parent's allowance or widow's pension, or who is only entitled to an age-related widow's pension calculated pursuant to point (b) of Article SSC.47(1) [Award of benefits] of the Protocol, and for this purpose 'age related widow's pension' means a widow's pension payable at a reduced rate in accordance with section 39(4) of the Social Security Contributions and Benefits Act 1992.

2. For the purposes of applying Article SSC.8 [Waiving of residence rules] of the Protocol in the case of old-age or survivors' cash benefits, pensions for accidents at work or occupational diseases and death grants, any beneficiary under United Kingdom legislation who is staying in the territory of another State shall, during that stay, be considered as if they resided in the territory of that other State.

3.

(1) For the purpose of calculating an earnings factor in order to determine entitlement to benefits under United Kingdom legislation, for each week of activity as an employed person under the legislation of a Member State, and which commenced during the relevant income tax year within the meaning of United Kingdom legislation, the person concerned shall be deemed to have paid contributions as an employed earner, or have earnings on which contributions have been paid, on the basis of earnings equivalent to two-thirds of that year's upper earnings limit.

(2) For the purposes of point (b) of Article SSC.47(1) [Award of benefits] of the Protocol, where:

- (a) in any income tax year starting on or after 6 April 1975, a person carrying out activity as an employed person has completed periods of insurance, employment or residence exclusively in a Member State, and the application of point (1) of this paragraph results in that year being counted as a qualifying year within the meaning of United Kingdom legislation for the purposes of point (b)(i) of Article SSC.47(1) [Award of benefits] of the Protocol, they shall be deemed to have been insured for 52 weeks in that year in that Member State;
  - (b) any income tax year starting on or after 6 April 1975 does not count as a qualifying year within the meaning of United Kingdom legislation for the purposes of point (b)(i) of Article SSC.47(1) [Award of benefits] of the Protocol, any periods of insurance, employment or residence completed in that year shall be disregarded.
- (3) For the purpose of converting an earnings factor into periods of insurance, the earnings factor achieved in the relevant income tax year within the meaning of United Kingdom legislation shall be divided by that year's lower earnings limit. The result shall be expressed as a whole number, any remaining fraction being ignored. The figure so calculated shall be treated as representing the number of weeks of insurance completed under United Kingdom legislation during that year, provided that such figure shall not exceed the number of weeks during which in that year the person was subject to that legislation.

## ANNEX SSC-7: IMPLEMENTING PART

### TITLE I: GENERAL PROVISIONS

#### CHAPTER 1

##### Article SSCI.1: Definitions

1. For the purposes of this Annex, the definitions set out in Article SSC.1 [Definitions] apply.
2. In addition to the definitions referred to in paragraph 1:
  - (a) “access point” means an entity providing:
    - (i) an electronic contact point;
    - (ii) automatic routing based on the address; and
    - (iii) intelligent routing based on software that enables automatic checking and routing (for example, an artificial intelligence application) or human intervention;
  - (b) “liaison body” means any body designated by the competent authority of a State for one or more of the branches of social security referred to in Article SSC.3 [Matters covered] of the Protocol to respond to requests for information and assistance for the purposes of the application of the Protocol and of this Annex and which has to fulfil the tasks assigned to it under Title IV [Financial provisions] of this Annex;
  - (c) “document” means a set of data, irrespective of the medium used, structured in such a way that it can be exchanged electronically and which must be communicated in order to enable the operation of the Protocol and this Annex;
  - (d) “Structured Electronic Document” means any structured document in a format designed for the electronic exchange of information between States;
  - (e) “transmission by electronic means” means the transmission of data using electronic equipment for the processing (including digital compression) of data and employing wires, radio transmission, optical technologies or any other electromagnetic means;
  - (f) “fraud” means any deliberate act or deliberate omission to act, carried out with the intention to either:
    - (i) receive social security benefits, or enable another person to receive social security benefits, when the conditions of entitlement to such benefits under the law of the State(s) concerned or the Protocol are not met; or
    - (ii) avoid paying social security contributions, or enable another person to avoid paying social security contributions, when such contributions are required under the law of the State(s) concerned or the Protocol.

#### CHAPTER 2: PROVISIONS CONCERNING COOPERATION AND EXCHANGES OF DATA



#### Article SSCI.2: Scope and rules for exchanges between institutions

1. For the purposes of this Annex, exchanges between authorities of the States and institutions and persons covered by the Protocol shall be based on the principles of public service, efficiency, active assistance, rapid delivery and accessibility, including e-accessibility, in particular for the disabled and the elderly.
2. The institutions shall without delay provide or exchange all data necessary for establishing and determining the rights and obligations of persons to whom the Protocol applies. Such data shall be transferred between the States directly by the institutions themselves or indirectly via the liaison bodies.
3. Where a person has mistakenly submitted information, documents or claims to an institution in the territory of a State other than that in which the institution designated, in accordance with this Annex, is situated, the information, documents or claims shall be resubmitted without delay by the former institution to the institution designated in accordance with this Annex, indicating the date on which they were initially submitted. That date shall be binding on the latter institution. The institutions of the States shall not, however, be held liable, or be deemed to have taken a decision by virtue of their failure to act as a result of the late transmission of information, documents or claims by States' institutions.
4. Where data are transferred indirectly via the liaison body of the State of destination, time limits for responding to claims shall start from the date when that liaison body received the claim, as if it had been received by the institution in that State.

#### Article SSCI.3: Scope and rules for exchanges between the persons concerned and institutions

1. The States shall ensure that the necessary information is made available to the persons concerned in order to inform them of the provisions introduced by the Protocol and this Annex to enable them to assert their rights. They shall also provide for user-friendly services.
2. Persons to whom the Protocol applies shall be required to forward to the relevant institution the information, documents or supporting evidence necessary to establish their situation or that of their families, to establish or maintain their rights and obligations and to determine the applicable legislation and their obligations under it.
3. To the extent necessary for the application of the Protocol and this Annex, the relevant institutions shall forward the information and issue the documents to the persons concerned without delay and in all cases within any time limits specified under the legislation of the State in question.

The relevant institution shall notify the claimant residing or staying in another State of its decision directly or through the liaison body of the State of residence or stay. When refusing the benefits, it shall also indicate the reasons for refusal, the remedies and periods allowed for appeals. A copy of this decision shall be sent to other involved institutions.

#### Article SSCI.4: Forms, documents and methods of exchanging data

1. Subject to Article SSCI.75 [Interim provisions for forms and documents] and Appendix SSCI-2 [Entitlement document], the structure, content and format of forms and documents issued on behalf of the States for the purposes of implementing the Protocol shall be agreed by the Specialised Committee on Social Security Coordination.

2. The transmission of data between the institutions or the liaison bodies may, subject to the approval of the Specialised Committee on Social Security Coordination, be carried out via the Electronic Exchange of Social Security Information. To the extent the forms and documents referred to in paragraph 1 are exchanged via the Electronic Exchange of Social Security Information, they shall respect the rules applicable to that system.

3. Where the transmission of data between institutions or the liaison bodies is not carried out via the Electronic Exchange of Social Security Information, the relevant institutions and liaison bodies shall use the arrangements appropriate to each case, and favour the use of electronic means as far as possible.

4. In their communications with the persons concerned, the relevant institutions shall use the arrangements appropriate to each case, and favour the use of electronic means as far as possible.

#### Article SSCI.5: Legal value of documents and supporting evidence issued in another State

1. Documents issued by the institution of a State and showing the position of a person for the purposes of the application of the Protocol and this Annex, and supporting evidence on the basis of which the documents have been issued, shall be accepted by the institutions of the other States for as long as they have not been withdrawn or declared to be invalid by the State in which they were issued.

2. Where there is doubt about the validity of a document or the accuracy of the facts on which the particulars contained therein are based, the institution of the State that receives the document shall ask the issuing institution for the necessary clarification and, where appropriate, the withdrawal of that document. The issuing institution shall reconsider the grounds for issuing the document and, if necessary, withdraw it.

3. Pursuant to paragraph 2, where there is doubt about the information provided by the persons concerned, the validity of a document or supporting evidence or the accuracy of the facts on which the particulars contained therein are based, the institution of the place of stay or residence shall, insofar as this is possible, at the request of the competent institution, proceed to the necessary verification of this information or document.

4. Where no agreement is reached between the institutions concerned, the matter may be brought before the Specialised Committee on Social Security Coordination by the competent authorities no earlier than one month following the date on which the institution that received the document submitted its request. The Specialised Committee on Social Security Coordination shall endeavour to reconcile the points of view within six months of the date on which the matter was brought before it.

#### Article SSCI.6 : Provisional application of legislation and provisional granting of benefits

1. Unless otherwise provided for in this Annex, where there is a difference of views between the institutions or authorities of two or more States concerning the determination of the applicable legislation, the person concerned shall be made provisionally subject to the legislation of one of those States, the order of priority being determined as follows:

(a) the legislation of the State where the person actually pursues their employment or self-employment, if the employment or self-employment is pursued in only one State;

- (b) the legislation of the State of residence if the person concerned pursues employment or self-employment in two or more States and performs part of their activity or activities in the State of residence, or if the person concerned is neither employed nor self-employed;
- (c) in all other cases, the legislation of the State the application of which was first requested if the person pursues an activity, or activities, in two or more States.

2. Where there is a difference of views between the institutions or authorities of two or more States about which institution should provide the benefits in cash or in kind, the person concerned who could claim benefits if there was no dispute shall be entitled, on a provisional basis, to the benefits provided for by the legislation applied by the institution of that person's place of residence or, if that person does not reside on the territory of one of the States concerned, to the benefits provided for by the legislation applied by the institution to which the request was first submitted.

3. Where no agreement is reached between the institutions or authorities concerned, the matter may be brought before the Specialised Committee on Social Security Coordination by a Party no earlier than one month after the date on which the difference of views, as referred to in paragraph 1 or 2 arose. The Specialised Committee on Social Security Coordination shall seek to reconcile the points of view within six months of the date on which the matter was brought before it.

4. Where it is established either that the applicable legislation is not that of the State of provisional membership, or the institution which granted the benefits on a provisional basis was not the competent institution, the institution identified as being competent shall be deemed retroactively to have been so, as if that difference of views had not existed, at the latest from either the date of provisional membership or of the first provisional granting of the benefits concerned.

5. If necessary, the institution identified as being competent and the institution which provisionally paid the cash benefits or provisionally received contributions shall settle the financial situation of the person concerned as regards contributions and cash benefits paid provisionally, where appropriate, in accordance with Title IV, Chapter 2 [Recovery of benefits provided but not due, recovery of provisional payments and contributions, offsetting and assistance with recovery], of this Annex.

Benefits in kind granted provisionally by an institution in accordance with paragraph 2 shall be reimbursed by the competent institution in accordance with Title IV [Financial provisions] of this Annex.

#### Article SSCI.7: Provisional calculation of benefits and contributions

1. Unless otherwise provided for in this Annex to the Protocol, where a person is eligible for a benefit, or is liable to pay a contribution in accordance with the Protocol, and the competent institution does not have all the information concerning the situation in another State which is necessary to calculate definitively the amount of that benefit or contribution, that institution shall, on request of the person concerned, award this benefit or calculate this contribution on a provisional basis, if such a calculation is possible on the basis of the information at the disposal of that institution.

2. The benefit or the contribution concerned shall be recalculated once all the necessary supporting evidence or documents are provided to the institution concerned.

### CHAPTER 3: OTHER GENERAL PROVISIONS FOR THE APPLICATION OF THE PROTOCOL

#### Article SSCI.8: Other procedures between authorities and institutions

1. Two or more States, or their competent authorities, may agree procedures other than those provided for by this Annex, provided that such procedures do not adversely affect the rights or obligations of the persons concerned.
2. Any agreements concluded to this end shall be notified to the Specialised Committee on Social Security Coordination and listed in the Appendix SSCI-1 [Implementing provisions for bilateral agreements remaining in force and new bilateral implementing agreements].
3. Provisions contained in implementing agreements concluded between two or more States with the same purpose as, or which are similar to, those referred to in paragraph 2, which are in force on the day preceding the entry into force of this Agreement, shall continue to apply, for the purposes of relations between those States, provided they are also included in Appendix SSCI-1 [Implementing provisions for bilateral agreements remaining in force and new bilateral implementing agreements].

#### Article SSCI.9 : Prevention of overlapping of benefits

Notwithstanding other provisions in the Protocol, when benefits due under the legislation of two or more States are mutually reduced, suspended or withdrawn, any amounts that would not be paid in the event of strict application of the rules concerning reduction, suspension or withdrawal laid down by the legislation of the State concerned shall be divided by the number of benefits subjected to reduction, suspension or withdrawal.

#### Article SSCI.10: Elements for determining residence

1. Where there is a difference of views between the institutions of two or more States about the determination of the residence of a person to whom the Protocol applies, these institutions shall establish by common agreement the centre of interests of the person concerned, based on an overall assessment of all available information relating to relevant facts, which may include, as appropriate:
  - (a) the duration and continuity of presence on the territory of the States concerned;
  - (b) that person's situation, including:
    - (i) the nature and the specific characteristics of any activity pursued, in particular the place where such activity is habitually pursued, the stability of the activity, and the duration of any work contract;
    - (ii) that person's family status and family ties;
    - (iii) the exercise of any non-remunerated activity;
    - (iv) in the case of students, the source of that student's income;
    - (v) that person's housing situation, in particular how permanent it is;
    - (vi) the State in which that person is deemed to reside for taxation purposes.
2. Where the consideration of the various criteria based on relevant facts as set out in paragraph 1 does not lead to agreement between the institutions concerned, the person's intention,

as it appears from such facts and circumstances, especially the reasons that led the person to move, shall be considered to be decisive for establishing that person's actual place of residence.

3. The centre of interest of a student who goes to another State to pursue a full time course of study shall not be considered as being in the State of study for the entire duration of the course of study in that State, without prejudice to the possibility of rebutting this presumption.

4. Paragraph 3 shall apply *mutatis mutandis* to the family members of the student.

#### Article SSCI.11: Aggregation of periods

1. For the purposes of applying Article SSC.7 [Aggregation of periods] of the Protocol the competent institution shall contact the institutions of the States to whose legislation the person concerned has also been subject in order to determine all the periods completed under their legislation.

2. The respective periods of insurance, employment, self-employment or residence completed under the legislation of a State shall be added to those completed under the legislation of any other State, insofar as necessary for the purposes of applying Article SSC.7 [Aggregation of periods] of the Protocol, provided that these periods do not overlap.

3. Where a period of insurance or residence which is completed in accordance with compulsory insurance under the legislation of a State coincides with a period of insurance completed on the basis of voluntary insurance or continued optional insurance under the legislation of another State, only the period completed on the basis of compulsory insurance shall be taken into account.

4. Where a period of insurance or residence other than an equivalent period completed under the legislation of a State coincides with an equivalent period on the basis of the legislation of another State, only the period other than an equivalent period shall be taken into account.

5. Any period regarded as equivalent under the legislation of two or more States shall be taken into account only by the institution of the State to whose legislation the person concerned was last compulsorily subject before that period. In the event that the person concerned was not compulsorily subject to the legislation of a State before that period, the latter shall be taken into account by the institution of the State to whose legislation the person concerned was compulsorily subject for the first time after that period.

6. In the event that the time in which certain periods of insurance or residence were completed under the legislation of a State cannot be determined precisely, it shall be presumed that these periods do not overlap with periods of insurance or residence completed under the legislation of another State, and account shall be taken thereof, where advantageous to the person concerned, insofar as they can reasonably be taken into consideration.

#### Article SSCI.12: Rules for conversion of periods

1. Where periods completed under the legislation of a State are expressed in units different from those provided for by the legislation of another State, the conversion needed for the purpose of aggregation under Article SSC.7 [Aggregation of periods] of the Protocol shall be carried out under the following rules:

(a) the period to be used as the basis for the conversion shall be that communicated by the institution of the State under whose legislation the period was completed;

- (b) in the case of schemes where the periods are expressed in days the conversion from days to other units, and vice versa, as well as between different schemes based on days shall be calculated according to the following table:

<b>Scheme based on</b>	<b>1 day corresponds to</b>	<b>1 week corresponds to</b>	<b>1 month corresponds to</b>	<b>1 quarter corresponds to</b>	<b>Maximum of days in one calendar year</b>
5 days	9 hours	5 days	22 days	66 days	264 days
6 days	8 hours	6 days	26 days	78 days	312 days
7 days	6 hours	7 days	30 days	90 days	360 days

- (c) in the case of schemes where the periods are expressed in units other than days,
- (i) three months or 13 weeks shall be equivalent to one quarter, and vice versa;
  - (ii) one year shall be equivalent to four quarters, 12 months or 52 weeks, and vice versa;
  - (iii) for the conversion of weeks into months, and vice versa, weeks and months shall be converted into days in accordance with the conversion rules for the schemes based on six days in the table in point (b);
- (d) in the case of periods expressed in fractions, those figures shall be converted into the next smaller integer unit applying the rules laid down in points (b) and (c). Fractions of years shall be converted into months unless the scheme involved is based on quarters;
- (e) if the conversion under this paragraph results in a fraction of a unit, the next higher integer unit shall be taken as the result of the conversion under this paragraph.

2. The application of paragraph 1 shall not have the effect of producing, for the total sum of the periods completed during one calendar year, a total exceeding the number of days indicated in the last column in the table in point (b) paragraph 1, 52 weeks, 12 months or four quarters.

If the periods to be converted correspond to the maximum annual amount of periods under the legislation of the State in which they have been completed, the application of paragraph 1 shall not result within one calendar year in periods that are shorter than the possible maximum annual amount of periods provided under the legislation concerned.

3. The conversion shall be carried out either in one single operation covering all those periods which were communicated as an aggregate, or for each year, if the periods were communicated on a year-by-year basis.

4. Where an institution communicates periods expressed in days, it shall at the same time indicate whether the scheme it administers is based on five days, six days or seven days.

## TITLE II: DETERMINATION OF THE LEGISLATION APPLICABLE

### Article SSCI.13: Details relating to Articles SSC.11 [Detached workers] and SSC.12 [Pursuit of activities in two or more States] of the Protocol

1. For the purposes of the application of point (a) of Article SSC.11(1) [Detached workers], a 'person who pursues an activity as an employed person in a State for an employer which normally carries out its activities there and who is sent by that employer to another State' shall include a person who is recruited with a view to being sent to another State, provided that, immediately before the start of that person's employment, the person concerned is already subject to the legislation of the State in which their employer is established.

2. For the purposes of the application of point (a) of Article SSC.11(1) [Detached workers] of the Protocol, the words 'which normally carries out its activities there' shall refer to an employer that ordinarily performs substantial activities, other than purely internal management activities, in the territory of the State in which it is established, taking account of all criteria characterising the activities carried out by the undertaking in question. The relevant criteria must be suited to the specific characteristics of each employer and the real nature of the activities carried out.

3. For the purposes of the application of point (b) of Article SSC.11(1) [Detached workers], the words 'who normally pursues an activity as a self-employed person' shall refer to a person who habitually carries out substantial activities in the territory of the State in which that person is established. In particular, that person must have already pursued their activity for some time before the date when they wish to take advantage of the provisions of that Article and, during any period of temporary activity in another State, must continue to fulfil, in the State where they are established, the requirements for the pursuit of their activity in order to be able to pursue it on their return.

4. For the purposes of the application of point (b) of Article SSC.11(1) [Detached workers], the criterion for determining whether the activity that a self-employed person goes to pursue in another State is 'similar' to the self-employed activity normally pursued shall be that of the actual nature of the activity, rather than of the designation of employed or self-employed activity that may be given to this activity by the other State.

5. For the purposes of the application of Article SSC.12(1) and (5) [Pursuit of activities in two or more States] of the Protocol, a person who 'normally pursues an activity as an employed person' in 'one or more Member States as well as the United Kingdom', or in 'two or more Member States' respectively, shall refer to a person who simultaneously, or in alternation, for the same undertaking or employer or for various undertakings or employers, exercises one or more separate activities in such States.

6. For the purposes of Article SSC.12(1) and (5) [Pursuit of activities in two or more States] of the Protocol, an employed flight crew or cabin crew member normally pursuing air passenger or freight services in two or more States shall be subject to the legislation of the State where the home base, as defined in Article SSC.1 [Definitions] of the Protocol, is located.

7. Marginal activities shall be disregarded for the purposes of determining the applicable legislation under Article SSC.12 [Pursuit of activities in two or more States] of the Protocol. Article SSCI.15 [Procedure for the application of Article SSC.12] of this Annex shall apply to all cases under this Article.

8. For the purposes of the application of Article SSC.12(2) and (6) [Pursuit of activities in two or more States] of the Protocol, a person who 'normally pursues an activity as a self-employed person'



in 'one or more Member States as well as the United Kingdom', or in 'two or more Member States respectively', shall refer, in particular, to a person who simultaneously or in alternation pursues one or more separate self-employed activities, irrespective of the nature of those activities, in such States.

9. For the purposes of distinguishing the activities under paragraphs 5 and 8 from the situations described in Article SSC.11(1) [Detached workers] of the Protocol, the duration of the activity in one or more States (whether it is permanent or of an ad hoc or temporary nature) shall be decisive. For these purposes, an overall assessment shall be made of all the relevant facts including, in particular, in the case of an employed person, the place of work as defined in the employment contract.

10. For the purposes of the application of Article SSC.12(1) (2), (5) and (6) [Pursuit of activities in two or more States] of the Protocol, a 'substantial part of employed or self-employed activity' pursued in a State shall mean a quantitatively substantial part of all the activities of the employed or self-employed person pursued there, without this necessarily being the major part of those activities.

11. To determine whether a substantial part of the activities is pursued in a State, the following indicative criteria shall be taken into account:

- (a) in the case of an employed activity, the working time or the remuneration; and
- (b) in the case of a self-employed activity, the turnover, working time, number of services rendered or income.

In the framework of an overall assessment, a share of less than 25% in respect of the criteria mentioned above shall be an indicator that a substantial part of the activities is not being pursued in the relevant State.

12. For the purposes of the application of point (b) of Article SSC.12(2) [Pursuit of activities in two or more States] of the Protocol, the 'centre of interest' of the activities of a self-employed person shall be determined by taking account of all the aspects of that person's occupational activities, notably the place where the person's fixed and permanent place of business is located, the habitual nature or the duration of the activities pursued, the number of services rendered, and the intention of the person concerned as revealed by all the circumstances.

13. For the determination of the applicable legislation under paragraphs 10, 11 and 12, the institutions concerned shall take into account the situation projected for the following 12 calendar months.

14. If a person pursues his or her activity as an employed person in two or more States on behalf of an employer established outside the territory of the States, and if this person resides in a State without pursuing substantial activity there, they shall be subject to the legislation of the State of residence.

Article SSCI.14: Procedures for the application of Article SSC.10(3)(b) and Article SSC.10(4) [General rules] and Article SSC.11 [Detached workers] of the Protocol (on the provision of information to the institutions concerned)

1. Unless otherwise provided for by Article SSCI.15 [Procedure for the application of Article SSC.12] of this Annex, where a person pursues their activity outside the competent State, the employer or, in the case of a person who does not pursue an activity as an employed person, the



person concerned shall inform the competent institution of the State whose legislation is applicable thereof, whenever possible in advance. That institution shall issue the attestation referred to in Article SSCI.16(2) [Provision of information to persons concerned and employers] of this Annex to the person concerned and shall without delay make information concerning the legislation applicable to that person, pursuant to point (b) of Article SSC.10(3) [General rules] or Article SSC.11 [Detached workers] of the Protocol, available to the institution designated by the competent authority of the State in which the activity is pursued.

2. An employer within the meaning of Article SSC.10(4) [General rules] of the Protocol who has an employee on board a vessel flying the flag of another State shall inform the competent institution of the State whose legislation is applicable thereof whenever possible in advance. That institution shall, without delay, make information concerning the legislation applicable to the person concerned, pursuant to Article SSC.10(4) [General rules] of the Protocol, available to the institution designated by the competent authority of the State whose flag, the vessel on which the employee is to perform the activity, is flying.

Article SSCI.15: Procedure for the application of Article SSC.12 [Pursuit of activities in two or more States] of the Protocol

1. A person who pursues activities in two or more States, or where Article SSC.12(5) or (6) [Pursuit of activities in two or more States] applies, shall inform the institution designated by the competent authority of the State of residence thereof.

2. The designated institution of the place of residence shall without delay determine the legislation applicable to the person concerned, having regard to Article SSC.12 [Pursuit of activities in two or more States] of the Protocol and Article SSCI.13 [Details relating to Articles SSC.11 [Detached workers] and SSC.12 [Pursuit of activities in two or more States] of this Annex. That initial determination shall be provisional. The institution shall inform the designated institutions of each State in which an activity is pursued of its provisional determination.

3. The provisional determination of the applicable legislation, as provided for in paragraph 2, shall become definitive within two months of the institutions designated by the competent authorities of the State(s) concerned being informed of it, in accordance with paragraph 2, unless the legislation has already been definitively determined on the basis of paragraph 4, or at least one of the institutions concerned informs the institution designated by the competent authority of the State of residence by the end of this two-month period that it cannot yet accept the determination or that it takes a different view on this.

4. Where uncertainty about the determination of the applicable legislation requires contacts between the institutions or authorities of two or more States, at the request of one or more of the institutions designated by the competent authorities of the State(s) concerned, or of the competent authorities themselves, the legislation applicable to the person concerned shall be determined by common agreement, having regard to Article SSC.12 [Pursuit of activities in two or more States] of the Protocol and the relevant provisions of Article SSCI.13 [Details relating to Articles SSC.11 [Detached workers] and SSC.12 [Pursuit of activities in two or more States]] of this Annex.

Where there is a difference of views between the institutions or competent authorities concerned, those bodies shall seek agreement in accordance with the conditions set out above and Article SSCI.6 [Provisional application of legislation and provisional granting of benefits] of this Annex shall apply.

5. The competent institution of the State whose legislation is determined to be applicable either provisionally or definitively shall without delay inform the person concerned.

6. If the person concerned fails to provide the information referred to in paragraph 1, this Article shall be applied at the initiative of the institution designated by the competent authority of the State of residence as soon as it is apprised of that person's situation, possibly via another institution concerned.

#### Article SSCI.16: Provision of information to persons concerned and employers

1. The competent institution of the State whose legislation becomes applicable pursuant to Title II [Determination of the legislation applicable] of the Protocol shall inform the person concerned and, where appropriate, their employer(s) of the obligations laid down in that legislation. It shall provide them with the necessary assistance to complete the formalities required by that legislation.

2. At the request of the person concerned or of the employer, the competent institution of the State whose legislation is applicable pursuant to Title II [Determination of the legislation applicable] of the Protocol shall provide an attestation that such legislation is applicable and shall indicate, where appropriate, until what date and under what conditions.

#### Article SSCI.17: Cooperation between institutions

1. The relevant institutions shall communicate to the competent institution of the State whose legislation is applicable to a person pursuant to Title II [Determination of the legislation applicable] of the Protocol the necessary information required to establish the date on which that legislation becomes applicable and the contributions which that person and his or her employer(s) are liable to pay under that legislation.

2. The competent institution of the State whose legislation becomes applicable to a person pursuant to Title II [Determination of the legislation applicable] of the Protocol shall make the information indicating the date on which the application of that legislation takes effect available to the institution designated by the competent authority of the State to whose legislation that person was last subject.

#### Article SSCI.18: Cooperation in case of doubts about the validity of issued documents concerning the applicable legislation

1. Where there is doubt about the validity of a document showing the position of the person for the purposes of the applicable legislation or the accuracy of the facts on which the document is based, the institution of the State that receives the document shall ask the issuing institution for the necessary clarification and, where appropriate, the withdrawal or rectification of that document. The requesting institution shall substantiate its request and provide the relevant supporting documentation that gave rise to the request.

2. When receiving such a request, the issuing institution shall reconsider the grounds for issuing the document and, where an error is detected, withdraw it or rectify it within 30 working days from the receipt of the request. The withdrawal or rectification shall have retroactive effect. However, in cases where there is a risk of disproportionate outcome, and in particular, of the loss of status as an insured person for the whole or part of the relevant period in the State(s) concerned, the States shall consider a more proportionate arrangement in such case. When the available evidence permits the issuing institution to find that the applicant of the document has committed fraud, it shall withdraw or rectify the document without delay and with retroactive effect.

## TITLE III: SPECIAL PROVISIONS CONCERNING THE VARIOUS CATEGORIES OF BENEFITS

### CHAPTER 1: SICKNESS, MATERNITY AND EQUIVALENT PATERNITY BENEFITS

#### Article SSCI.19: General implementing provisions

1. The competent authorities or institutions shall ensure that any necessary information is made available to insured persons regarding the procedures and conditions for the granting of benefits in kind where such benefits are received in the territory of a State other than that of the competent institution.

2. Notwithstanding point (a) of Article SSC.6 [Equal treatment of benefits, income, facts or events] of the Protocol, a State may become responsible for the cost of benefits in accordance with Article SSC.20 [Pension claimants] of the Protocol only if, either the insured person has made a claim for a pension under the legislation of that State, or in accordance with Articles SSC.21 [Right to benefits in kind under the legislation of the State of residence] to SSC.27 [Contributions by pensioners] of the Protocol, they receive a pension under the legislation of that State.

#### Article SSCI.20: Regime applicable in the event of the existence of more than one regime in the State of residence or stay

If the legislation of the State of residence or stay comprises more than one scheme of sickness, maternity and paternity insurance for more than one category of insured persons, the provisions applicable under Articles SSC.15 [Residence in a State other than the competent State], SSC.17(1) [Stay outside the competent State], SSC.18 [Travel with the purpose of receiving benefits in kind – authorisation to receive appropriate treatment outside the State of residence], SSC.20 [Pension claimants], SSC.22 [No right to benefits in kind under the legislation of the State of residence] and SSC.24 [Residence of members of the family in a State other than the one in which the pensioner resides] of the Protocol shall be those of the legislation on the general scheme for employed persons.

#### Article SSCI.21: Residence in a State other than the competent State

##### *Procedure and scope of right*

1. For the purposes of the application of Article SSC.15 [Residence in a State other than the competent State], of the Protocol, the insured person or members of that person's family shall be obliged to register promptly with the institution of the place of residence. Their right to benefits in kind in the State of residence shall be certified by a document issued by the competent institution upon request of the insured person or upon request of the institution of the place of residence.

2. The document referred to in paragraph 1 shall remain valid until the competent institution informs the institution of the place of residence of its cancellation.

The institution of the place of residence shall inform the competent institution of any registration under paragraph 1 and of any change or cancellation of that registration.

3. This Article shall apply *mutatis mutandis* to the persons referred to in Articles SSC.20 [Pension claimants], SSC.22 [No right to benefits in kind under the legislation of the State of residence] and SSC.23 [Pensions under the legislation of one or more States other than the State of residence, where there is a right to benefits in kind in the latter State], SSC.24 [Residence of members of the family in a State other than the one in which the pensioner resides] of the Protocol.

### *Reimbursement*

4. Where a person or the members of that person's family:
  - (a) have been issued with the document referred to in paragraph 1;
  - (b) have registered that document with the institution of the place of residence in accordance with paragraph 1; and
  - (c) a health fee has been paid by or on behalf of the person or members of their family to the State of residence as part of an application for a permit to enter, stay, work or reside in that State,

that person or members of that person's family may apply to the institution of the State of residence for reimbursement (in whole or part, as the case may be) of the health fee paid.

4. Where a claim is made in accordance with paragraph 1, the institution of the State of residence shall determine that claim within three calendar months, starting on the day the claim was received, and shall make any reimbursement in accordance with this Article.

5. Where the period of validity of the document referred to in paragraph 1 is less than the period of time in respect of which the health fee has been paid, the amount reimbursed shall not exceed that portion of the health fee which corresponds to the period for which the document had been issued.

6. Where the health fee was paid by another person on behalf of a person to whom this Article applies, reimbursement may be made to that other person.

### Article SSCI.22: Stay in a State other than the competent State

#### *Procedure and scope of right*

1. For the purposes of the application of Article SSC.17 [Stay outside the competent State] of the Protocol, the insured person shall present to the health care provider in the State of stay an entitlement document issued by the competent institution indicating his entitlement to benefits in kind. If the insured person does not have such a document, the institution of the place of stay, upon request or if otherwise necessary, shall contact the competent institution in order to obtain one.

2. That document shall indicate that the insured person is entitled to benefits in kind under the conditions laid down in Article SSC.17 [Stay outside the competent State] of the Protocol on the same terms as those applicable to persons insured under the legislation of the State of stay, and shall satisfy the requirements in Appendix SSCI.2.

3. The benefits in kind referred to in Article SSC.17(1) [Stay outside the competent State] of the Protocol shall refer to the benefits in kind which are provided in the State of stay, in accordance with its legislation, and which become necessary on medical grounds with a view to preventing an insured person from being forced to return, before the end of the planned duration of stay, to the competent State to obtain the necessary treatment.

#### *Procedure and arrangements for meeting the costs and providing reimbursement of benefits in kind*

4. If the insured person has actually borne the costs of all or part of the benefits in kind provided within the framework of Article SSC.17 [Stay outside the competent State] of the Protocol and if the legislation applied by the institution of the place of stay enables reimbursement of those

costs to an insured person, they may send an application for reimbursement to the institution of the place of stay. In that case, that institution shall reimburse directly to that person the amount of the costs corresponding to those benefits within the limits of and under the conditions of the reimbursement rates laid down in its legislation.

5. If the reimbursement of such costs has not been requested directly from the institution of the place of stay, the costs incurred shall be reimbursed to the person concerned by the competent institution in accordance with the reimbursement rates administered by the institution of the place of stay or the amounts which would have been subject to reimbursement to the institution of the place of stay, if Article SSCI.47 [Principles] of this Annex had applied in the case concerned.

The institution of the place of stay shall provide the competent institution, upon request, with all necessary information about these rates or amounts.

6. By way of derogation from paragraph 5, the competent institution may undertake the reimbursement of the costs incurred within the limits of and under the conditions of the reimbursement rates laid down in its legislation, provided that the insured person has agreed to this provision being applied to them.

7. If the legislation of the State of stay does not provide for reimbursement pursuant to paragraphs 4 and 5 in the case concerned, the competent institution may reimburse the costs within the limits of and under the conditions of the reimbursement rates laid down in its legislation, without the agreement of the insured person.

8. The reimbursement to the insured person shall not, in any event, exceed the amount of costs actually incurred by them.

9. In the case of substantial expenditure, the competent institution may pay the insured person an appropriate advance as soon as that person submits the application for reimbursement to it.

#### *Family Members*

10. Paragraphs 1 to 9 shall apply *mutatis mutandis* to the members of the family of the insured person.

#### *Reimbursement for students*

11. Where a person:

- (a) holds a valid entitlement document referred to in Appendix SSCI-2 issued by the competent institution;
- (b) has been accepted by a higher education institution in a State other than the competent State ("State of study") to pursue a full time course of study leading to a higher education qualification recognised by that State, including diplomas, certificates or doctoral degrees at a higher education institution, which may cover a preparatory course prior to such education, in accordance with national law, or compulsory training;
- (c) does not exercise, or has not exercised, an activity as an employed or self-employed person in the State of study during the period to which the health fee relates; and
- (d) a health fee has been paid by or on behalf of that person to the State of study as part of an application for a permit to enter, stay or reside for the purposes of pursuing a full time course of study in that State;

that person may apply to the institution of the State of study for reimbursement (in whole or part, as the case may be) of the health fee paid.

12. Where a claim is made in accordance with paragraph 11, the institution of the State of study shall process and settle that claim within a reasonable period but not later than six calendar months starting on the day the claim was received and make any reimbursement in accordance with this Article.

13. Where the period of validity of the entitlement document referred to in point (a) of paragraph 11 is less than the period of time in respect of which the health fee has been paid, the amount of the health fee reimbursed shall be the amount paid which corresponds to the period of validity of that document.

14. Where the health fee was paid by another person on behalf of a person to whom this Article applies, reimbursement may be made to that other person.

15. Paragraphs 11 to 14 shall apply *mutatis mutandis* to the members of the family of that person.

16. This Article shall enter into force 12 months after the date of entry into force of this Agreement.

17. A person who satisfied the conditions in paragraph 11 in the period between the entry into force of this Agreement and the date specified in paragraph 16 may, upon the entry into force of this Article, make a claim for reimbursement under paragraph 11 in relation to that period.

18. By way of derogation from Article SSC.5(1) [Equality of treatment], charges may be imposed by the State of study in accordance with its national law in respect of benefits in kind that do not fulfil the criteria set out in point (a) of Article SSC.17(1) [Stay outside the competent State] and which are provided to a person in respect of whom reimbursement has been made during that person's stay for the period to which that reimbursement relates.

#### Article SSCI.23: Scheduled treatment

##### *Authorisation procedure*

1. For the purposes of the application of Article SSC.18(1) [Travel with the purpose of receiving benefits in kind – authorisation to receive appropriate treatment outside the State of residence] of the Protocol, the insured person shall present a document issued by the competent institution to the institution of the place of stay. For the purposes of this Article, the competent institution shall mean the institution which bears the cost of the scheduled treatment; in the cases referred to in Article SSC.18(4) [Travel with the purpose of receiving benefits in kind – authorisation to receive appropriate treatment outside the State of residence] and SSC.25(5) [Stay of the pensioner or the members of their family in a State other than the State of residence – stay in the competent State – authorisation for appropriate treatment outside the State of residence] of the Protocol, in which the benefits in kind provided in the State of residence are reimbursed on the basis of fixed amounts, the competent institution shall mean the institution of the place of residence.

2. If an insured person does not reside in the competent State, they shall request authorisation from the institution of the place of residence, which shall forward it to the competent institution without delay.

In that event, the institution of the place of residence shall certify in a statement whether the conditions set out in the second sentence of Article SSC.18(2) [Travel with the purpose of receiving benefits in kind – authorisation to receive appropriate treatment outside the State of residence] of the Protocol are met in the State of residence.

The competent institution may refuse to grant the requested authorisation only if, in accordance with the assessment of the institution of the place of residence, the conditions set out in the second sentence of Article SSC.18(2) [Travel with the purpose of receiving benefits in kind – authorisation to receive appropriate treatment outside the State of residence] of the Protocol are not met in the State of residence of the insured person, or if the same treatment can be provided in the competent State itself, within a time-limit which is medically justifiable, taking into account the current state of health and the probable course of illness of the person concerned.

The competent institution shall inform the institution of the place of residence of its decision.

In the absence of a reply within the deadlines set by its national legislation, the authorisation shall be considered to have been granted by the competent institution.

3. If an insured person who does not reside in the competent Party is in need of urgent vitally necessary treatment, and the authorisation cannot be refused in accordance with the second sentence of Article SSC.18(2) [Travel with the purpose of receiving benefits in kind – authorisation to receive appropriate treatment outside the State of residence] of the Protocol, the authorisation shall be granted by the institution of the place of residence on behalf of the competent institution, which shall be immediately informed by the institution of the place of residence.

The competent institution shall accept the findings and the treatment options of the doctors approved by the institution of the place of residence that issues the authorisation, concerning the need for urgent vitally necessary treatment.

4. At any time during the procedure granting the authorisation, the competent institution shall retain the right to have the insured person examined by a doctor of its own choice in the Party of stay or residence.

5. The institution of the place of stay shall, without prejudice to any decision regarding authorisation, inform the competent institution if it appears medically appropriate to supplement the treatment covered by the existing authorisation.

#### *Meeting the cost of benefits in kind incurred by the insured person*

6. Without prejudice to paragraph 7, Article SSCI.22(4) and (5) [Stay in a State other than the competent State] of this Annex shall apply *mutatis mutandis*.

7. If the insured person has actually borne all or part of the costs for the authorised medical treatment themselves and the costs which the competent institution is obliged to reimburse to the institution of the place of stay or to the insured person according to paragraph 6 (actual cost) are lower than the costs which it would have had to assume for the same treatment in the competent State (notional cost), the competent institution shall reimburse, upon request, the cost of treatment incurred by the insured person up to the amount by which the notional cost exceeds the actual cost. The reimbursed sum may not, however, exceed the costs actually incurred by the insured person and may take account of the amount which the insured person would have had to pay if the treatment had been delivered in the competent State.



*Meeting the costs of travel and stay as part of scheduled treatment*

8. Where the national legislation of the competent institution provides for the reimbursement of the costs of travel and stay which are inseparable from the treatment of the insured person, such costs for the person concerned and, if necessary, for a person who must accompany them, shall be assumed by this institution when an authorisation is granted in the case of treatment in another State.

*Family members*

9. Paragraphs 1 to 8 shall apply *mutatis mutandis* to the members of the family of the insured person.

Article SSCI.24: Cash benefits relating to incapacity for work in the event of stay or residence in a State other than the competent State

*Procedure to be followed by the insured person*

1. If the legislation of the competent State requires that the insured person presents a certificate in order to be entitled to cash benefits relating to incapacity for work pursuant to Article SSC.19(1) [Cash benefits] of the Protocol, the insured person shall ask the doctor of the State of residence who established that person's state of health to certify his or her incapacity for work and its probable duration.

2. The insured person shall send the certificate to the competent institution within the time limit laid down by the legislation of the competent State.

3. Where the doctors providing treatment in the State of residence do not issue certificates of incapacity for work, and where such certificates are required under the legislation of the competent State, the person concerned shall apply directly to the institution of the place of residence. That institution shall immediately arrange for a medical assessment of the person's incapacity for work and for the certificate referred to in paragraph 1 to be drawn up. The certificate shall be forwarded to the competent institution forthwith.

4. The forwarding of the document referred to in paragraphs 1, 2 and 3 shall not exempt the insured person from fulfilling the obligations provided for by the applicable legislation, in particular with regard to that person's employer. Where appropriate, the employer or the competent institution may call upon the employee to participate in activities designed to promote and assist his or her return to employment.

*Procedure to be followed by the institution of the State of residence*

5. At the request of the competent institution, the institution of the place of residence shall carry out any necessary administrative checks or medical examinations of the person concerned in accordance with the legislation applied by this latter institution. The report of the examining doctor concerning, in particular, the probable duration of the incapacity for work, shall be forwarded without delay by the institution of the place of residence to the competent institution.

*Procedure to be followed by the competent institution*

6. The competent institution shall reserve the right to have the insured person examined by a doctor of its choice.



7. Without prejudice to the second sentence of Article SSC.19(1) [Cash benefits] of the Protocol, the competent institution shall pay the cash benefits directly to the person concerned and shall, where necessary, inform the institution of the place of residence thereof.

8. For the purposes of the application of Article SSC.19(1) [Cash benefits] of the Protocol, the particulars of the certificate of incapacity for work of an insured person drawn up in another State on the basis of the medical findings of the examining doctor or institution shall have the same legal value as a certificate drawn up in the competent State.

9. If the competent institution refuses the cash benefits, it shall notify its decision to the insured person and at the same time to the institution of the place of residence.

*Procedure in the event of a stay in a State other than the competent State*

10. Paragraphs 1 to 9 shall apply *mutatis mutandis* when the insured person stays in a State other than the competent State.

Article SSCI.25: Contributions by pensioners

If a person receives a pension from more than one State, the amount of contributions deducted from all the pensions paid shall, under no circumstances, be greater than the amount deducted in respect of a person who receives the same amount of pension from the competent State.

Article SSCI.26: Special implementing measures

1. When a person or a group of persons are exempted upon request from compulsory sickness insurance and such persons are thus not covered by a sickness insurance scheme to which the Protocol applies, the institution of a State shall not, solely because of this exemption, become responsible for bearing the costs of benefits in kind or in cash provided to such persons or to a member of their family under Title III, Chapter I [Sickness, maternity and equivalent paternity benefits], of the Protocol.

2. When the persons referred to in paragraph 1 and the members of their families reside in a State where the right to receive benefits in kind is not subject to conditions of insurance, or of activity as an employed or self-employed person, they shall be liable to pay the full costs of benefits in kind provided in their State of residence.

CHAPTER 2: BENEFITS IN RESPECT OF ACCIDENTS AT WORK AND OCCUPATIONAL DISEASES

Article SSCI.27: Right to benefits in kind and in cash in the event of residence or stay in a State other than the competent State

1. For the purposes of the application of Article SSC.31 [Right to benefits in kind and in cash] of the Protocol, the procedures laid down in Articles SSCI.21 [Residence in a State other than the competent State] to SSCI.24 [Cash benefits relating to incapacity for work in the event of stay or residence in a State other than the competent State] of this Annex shall apply *mutatis mutandis*.

2. When providing special benefits in kind in connection with accidents at work and occupational diseases under the national legislation of the State of stay or residence, the institution of that State shall without delay inform the competent institution.

Article SSCI.28: Procedure in the event of an accident at work or occupational disease which occurs in a State other than the competent State

1. If an accident at work occurs or an occupational disease is diagnosed for the first time in a State other than the competent State, the declaration or notification of the accident at work or the occupational disease, where the declaration or notification exists under national legislation, shall be carried out in accordance with the legislation of the competent State, without prejudice, where appropriate, to any other applicable legal provisions in force in the State in which the accident at work occurred or in which the first medical diagnosis of the occupational disease was made, which remain applicable in such cases. The declaration or notification shall be addressed to the competent institution.
2. The institution of the State in the territory of which the accident at work occurred or in which the occupational disease was first diagnosed, shall notify the competent institution of medical certificates drawn up in the territory of that State.
3. Where, as a result of an accident while travelling to or from work which occurs in the territory of a State other than the competent State, an inquiry is necessary in the territory of the first State in order to determine any entitlement to relevant benefits, a person may be appointed for that purpose by the competent institution, which shall inform the authorities of that State. The institutions shall cooperate with each other in order to assess all relevant information and to consult the reports and any other documents relating to the accident.
4. Following treatment, a detailed report accompanied by medical certificates relating to the permanent consequences of the accident or disease, in particular the injured person's present state and the recovery or stabilisation of injuries, shall be sent upon request of the competent institution. The relevant fees shall be paid by the institution of the place of residence or of stay, where appropriate, at the rate applied by that institution to the charge of the competent institution.
5. At the request of the institution of the place of residence or stay, where appropriate, the competent institution shall notify it of the decision setting the date for the recovery or stabilisation of injuries and, where appropriate, the decision concerning the granting of a pension.

Article SSCI.29: Disputes concerning the occupational nature of the accident or disease

1. Where the competent institution disputes the application of the legislation relating to accidents at work or occupational diseases under Article SSC.31(2) [Right to benefits in kind and in cash] of the Protocol, it shall without delay inform the institution of the place of residence or stay which provided the benefits in kind, which will then be considered as sickness insurance benefits.
2. When a final decision has been taken on that subject, the competent institution shall, without delay, inform the institution of the place of residence or stay which provided the benefits in kind.

Where an accident at work or occupational disease is not established, benefits in kind shall continue to be provided as sickness benefits if the person concerned is entitled to them.

Where an accident at work or occupational disease is established, sickness benefits in kind provided to the person concerned shall be considered as accident at work or occupational disease benefits from the date on which the accident at work occurred or the occupational disease was first medically diagnosed.

3. The second subparagraph of Article SSCI.6(5) [Provisional application of legislation and provisional granting of benefits] of this Annex shall apply *mutatis mutandis*.

Article SSCI.30: Procedure in the event of exposure to the risk of an occupational disease in two or more States

1. In the case referred to in Article SSC.33 [Benefits for an occupational disease where the person suffering from such a disease has been exposed to the same risk in several States] of the Protocol, the declaration or notification of the occupational disease shall be sent to the competent institution for occupational diseases of the last State under the legislation of which the person concerned pursued an activity likely to cause that disease.

When the institution to which the declaration or notification was sent establishes that an activity likely to cause the occupational disease in question was last pursued under the legislation of another State, it shall send the declaration or notification and all accompanying certificates to the equivalent institution in that State.

2. Where the institution of the last State under the legislation of which the person concerned pursued an activity likely to cause the occupational disease in question establishes that the person concerned or his survivors do not meet the requirements of that legislation, inter alia, because the person concerned had never pursued in that State an activity which caused the occupational disease or because that State does not recognise the occupational nature of the disease, that institution shall forward without delay the declaration or notification and all accompanying certificates, including the findings and reports of medical examinations performed by the first institution to the institution of the previous State under the legislation of which the person concerned pursued an activity likely to cause the occupational disease in question.

3. Where appropriate, the institutions shall reiterate the procedure set out in paragraph 2 going back as far as the equivalent institution in the State under whose legislation the person concerned first pursued an activity likely to cause the occupational disease in question.

Article SSCI.31: Exchange of information between institutions and advance payments in the event of an appeal against rejection

1. In the event of an appeal against a decision to refuse benefits taken by the institution of a State under the legislation of which the person concerned pursued an activity likely to cause the occupational disease in question, that institution shall inform the institution to which the declaration or notification was sent, in accordance with the procedure provided for in Article SSCI.30(2) [Procedure in the event of exposure to the risk of an occupational disease in two or more States] of this Annex, and shall subsequently inform it when a final decision is reached.

2. Where a person is entitled to benefits under the legislation applied by the institution to which the declaration or notification was sent, that institution shall make the advance payments, the amount of which shall be determined, where appropriate, after consulting the institution which made the decision against which the appeal was lodged, and in such a way that overpayments are avoided. The latter institution shall reimburse the advance payments made if, as a result of the appeal, it is obliged to provide those benefits. That amount will then be deducted from the benefits due to the person concerned, in accordance with the procedure provided for in Articles SSCI.56 [Benefits received unduly] and 57 [Provisionally paid benefits in cash or contributions] of this Annex.

3. The second subparagraph of Article SSCI.6(5) [Provisional application of legislation and provisional granting of benefits] of this Annex shall apply *mutatis mutandis*.

#### Article SSCI.32: Aggravation of an occupational disease

In the cases covered by Article SSC.34 [Aggravation of an occupational disease] of the Protocol, the claimant must provide the institution in the State from which they are claiming entitlement to benefits with details concerning benefits previously granted for the occupational disease in question. That institution may contact any other previously competent institution in order to obtain the information it considers necessary.

#### Article SSCI.33: Assessment of the degree of incapacity in the event of occupational accidents or diseases which occurred previously or subsequently

Where a previous or subsequent incapacity for work was caused by an accident which occurred when the person concerned was subject to the legislation of a State which makes no distinction according to the origin of the incapacity to work, the competent institution or the body designated by the competent authority of the State in question shall:

- (a) upon request by the competent institution of another State, provide information concerning the degree of the previous or subsequent incapacity for work, and where possible, information making it possible to determine whether the incapacity is the result of an accident at work within the meaning of the legislation applied by the institution in the other State;
- (b) take into account the degree of incapacity caused by these previous or subsequent cases when determining the right to benefits and the amount, in accordance with the applicable legislation.

#### Article SSCI.34: Submission and investigation of claims for pensions or supplementary allowances

In order to receive a pension or supplementary allowance under the legislation of a State, the person concerned or their survivors residing in the territory of another State shall submit, where appropriate, a claim either to the competent institution or to the institution of the place of residence, which shall send it to the competent institution.

The claim shall contain the information required under the legislation applied by the competent institution.

### CHAPTER 3: DEATH GRANTS

#### Article SSCI.35: Claim for death grants

For the purposes of applying Articles SSC.37 [Right to grants where death occurs in a State other than the competent one] and SSC.38 [Provision of benefits in the event of the death of a pensioner] of the Protocol, the claim for death grants shall be sent either to the competent institution or to the institution of the claimant's place of residence, which shall send it to the competent institution.

The claim shall contain the information required under the legislation applied by the competent institution.

## CHAPTER 4: INVALIDITY BENEFITS AND OLD-AGE AND SURVIVORS' PENSIONS

### Article SSCI.36: Additional provisions for the calculation of the benefit

1. For the purposes of calculating the theoretical amount and the actual amount of the benefit in accordance with Article SSC.47(1)(b) [Award of benefits] of the Protocol, the rules provided for in Article SSCI.11(3), (4), (5) and (6) [Aggregation of periods] of the Annex shall apply.
2. Where periods of voluntary or optional continued insurance have not been taken into account under Article SSC.11(3)[Aggregation of periods] of this Annex , the institution of the State under whose legislation those periods were completed shall calculate the amount corresponding to those periods under the legislation it applies. The actual amount of the benefit, calculated in accordance with Article SSC.47(1)(b) [Award of benefits] of the Protocol, shall be increased by the amount corresponding to periods of voluntary or optional continued insurance.
3. The institution of each State shall calculate, under the legislation it applies, the amount due corresponding to periods of voluntary or optional continued insurance which, under Article SSC.48(3)(c) [Rules to prevent overlapping] of the Protocol, shall not be subject to the another State's rules relating to withdrawal, reduction or suspension.

Where the legislation applied by the competent institution does not allow it to determine this amount directly, on the grounds that that legislation allocates different values to insurance periods, a notional amount may be established. The Specialised Committee on Social Security Coordination shall lay down the detailed arrangements for the determination of that notional amount.

### Article SSCI.37: Claims for benefits

#### A. Submission of claims for old-age and survivors' pensions

1. The claimant shall submit a claim to the institution of his place of residence or to the institution of the last State whose legislation was applicable. If the person concerned was not, at any time, subject to the legislation applied by the institution of the place of residence, that institution shall forward the claim to the institution of the last State whose legislation was applicable.
2. The date of submission of the claim shall apply in all the institutions concerned.
3. By way of derogation from paragraph 2, if the claimant does not, despite having been asked to do so, notify the fact that he or she has been employed or has resided in other States, the date on which the claimant completes his or her initial claim or submits a new claim for his or her missing periods of employment or/and residence in a State shall be considered as the date of submission of the claim to the institution applying the legislation in question, subject to more favourable provisions of that legislation.

### Article SSCI.38: Certificates and information to be submitted with the claim by the claimant

1. The claim shall be submitted by the claimant in accordance with the provisions of the legislation applied by the institution referred to in Article SSCI.37(1) [Claims for benefits] of this Annex, and be accompanied by the supporting documents required by that legislation. In particular, the claimant shall supply all available relevant information and supporting documents relating to periods of insurance (institutions, identification numbers), employment (employers) or self-employment (nature and place of activity) and residence (addresses) which may have been completed under other legislation, as well as the length of those periods.

2. Where, in accordance with Article SSC.45(1) [General Provisions] of the Protocol, the claimant requests deferment of the award of old-age benefits under the legislation of one or more States, the claimant shall state that in their claim and specify under which legislation the deferment is requested. In order to enable the claimant to exercise that right, the institutions concerned shall, upon the request of the claimant, notify them of all the information available to them so that he or she can assess the consequences of concurrent or successive awards of benefits which they might claim.

3. Should the claimant withdraw a claim for benefits provided for under the legislation of a particular State, that withdrawal shall not be considered as a concurrent withdrawal of claims for benefits under the legislation of another State.

#### Article SSCI.39: Investigation of claims by the institutions concerned

##### *Contact institution*

1. The institution to which the claim for benefits is submitted or forwarded in accordance with Article SSCI.37(1) [Claims for benefits] of this Annex to the Protocol shall be referred to hereinafter as the 'contact institution'. The institution of the place of residence shall not be referred to as the contact institution if the person concerned has not, at any time, been subject to the legislation which that institution applies.

In addition to investigating the claim for benefits under the legislation which it applies, this institution shall, in its capacity as contact institution, promote the exchange of data, the communication of decisions and the operations necessary for the investigation of the claim by the institutions concerned, and supply the claimant, upon request, with any information relevant to the aspects of the investigation which arise under the Protocol, and keep the claimant informed of its progress.

##### *Investigation of claims for old-age and survivors pensions*

2. The contact institution shall, without delay, send claims for benefits and all the documents which it has available and, where appropriate, the relevant documents supplied by the claimant to all the institutions in question so that they can all start the investigation of the claim concurrently. The contact institution shall notify the other institutions of periods of insurance or residence subject to its legislation. It shall also indicate which documents shall be submitted at a later date and supplement the claim as soon as possible.

3. Each of the institutions in question shall notify the contact institution and the other institutions in question, as soon as possible, of the periods of insurance or residence subject to their legislation.

4. Each of the institutions in question shall calculate the amount of benefits in accordance with Article SSC.47 [Award of benefits] of the Protocol and shall notify the contact institution and the other institutions concerned of its decision, of the amount of benefits due and of any information required for the purposes of Articles SSC.48 [Rules to prevent overlapping] to SSC.50 [Overlapping of benefits of a different kind] of the Protocol.

5. Should an institution establish, on the basis of the information referred to in paragraphs 2 and 3 of this Article, that Article SSC.52(2) or (3) [Periods of insurance or residence of less than one year] of the Protocol is applicable, it shall inform the contact institution and the other institutions concerned.

#### Article SSCI.40: Notification of decisions to the claimant

1. Each institution shall notify the claimant of the decision it has taken in accordance with the applicable legislation. Each decision shall specify the remedies and periods allowed for appeals. Once the contact institution has been notified of all decisions taken by each institution, it shall send the claimant and the other institutions concerned a summary of those decisions. A model summary shall be drawn up by the Specialised Committee on Social Security Coordination. The summary shall be sent to the claimant in the language of the institution or, at the request of the claimant, in any language of their choice, including English, recognised as an official language of the Union.
2. Where it appears to the claimant following receipt of the summary that his or her rights may have been adversely affected by the interaction of decisions taken by two or more institutions, the claimant shall have the right to a review of the decisions by the institutions concerned within the time limits laid down in the respective national legislation. The time limits shall commence on the date of receipt of the summary. The claimant shall be notified of the result of the review in writing.

#### Article SSCI.41: Determination of the degree of invalidity

Each institution shall, in accordance with its legislation, have the possibility of having the claimant examined by a medical doctor or other expert of its choice to determine the degree of invalidity. However, the institution of a State shall take into consideration documents, medical reports and administrative information collected by the institution of any other State as if they had been drawn up in its own territory.

#### Article SSCI.42: Provisional instalments and advance payment of a benefit

1. Notwithstanding Article SSCI.7 [Provisional calculation of benefits and contributions] of this Annex, any institution which establishes, while investigating a claim for benefits, that the claimant is entitled to an independent benefit under the applicable legislation, in accordance with point (a) of Article SSC.47(1) [Award of benefits], shall pay that benefit without delay. That payment shall be considered provisional if the amount might be affected by the result of the claim investigation procedure.
2. Whenever it is evident from the information available that the claimant is entitled to a payment from an institution under point (b) of Article SSC.47(1) [Award of benefits] of the Protocol, that institution shall make an advance payment, the amount of which shall be as close as possible to the amount which will probably be paid under point (b) of Article SSC.47(1) [Award of benefits] of the Protocol.
3. Each institution which is obliged to pay the provisional benefits or advance payment under paragraphs 1 or 2 shall inform the claimant without delay, specifically drawing the claimant's attention to the provisional nature of the measure and any rights of appeal in accordance with its legislation.

#### Article SSCI.43: New calculation of benefits

1. Where there is a new calculation of benefits in accordance with Article SSC.45(4) [General provisions] and 54(1) [Recalculation and revaluation of benefits] of the Protocol, Article SSCI.42 [Provisional instalments and advance payment of a benefit] of this Annex shall be applicable *mutatis mutandis*.



2. Where there is a new calculation, withdrawal or suspension of the benefit, the institution which took the decision shall inform the person concerned without delay and shall inform each of the institutions in respect of which the person concerned has an entitlement.

#### Article SSCI.44: Measures intended to accelerate the pension calculation process

1. In order to facilitate and accelerate the investigation of claims and the payment of benefits, the institutions to whose legislation a person has been subject shall:

- (a) exchange with or make available to institutions of other States the elements for identifying persons who change from one applicable national legislation to another, and together ensure that those identification elements are retained and correspond, or, failing that, provide those persons with the means to access their identification elements directly;
- (b) sufficiently in advance of the minimum age for commencing pension rights or before an age to be determined by national legislation, exchange with or make available to the person concerned and to institutions of other States information (periods completed or other important elements) on the pension entitlements of persons who have changed from one applicable legislation to another or, failing that, inform those persons of, or provide them with, the means of familiarising themselves with their prospective benefit entitlement.

2. For the purposes of applying paragraph 1, the Specialised Committee on Social Security Coordination shall determine the elements of information to be exchanged or made available and shall establish the appropriate procedures and mechanisms, taking account of the characteristics, administrative and technical organisation, and the technological means at the disposal of national pension schemes. The Specialised Committee on Social Security Coordination shall ensure the implementation of those pension schemes by organising a follow-up to the measures taken and their application.

3. For the purposes of applying paragraph 1, the institution in the first State where a person is allocated a Personal Identification Number (PIN) for the purposes of social security administration should be provided with the information referred to in this Article.

#### Article SSCI.45: Coordination measures in the States

1. Without prejudice to Article SSC.46 [Special provisions on aggregation of periods] of the Protocol, where national legislation includes rules for determining the institution responsible or the scheme applicable or for designating periods of insurance to a specific scheme, those rules shall be applied, taking into account only periods of insurance completed under the legislation of the State concerned.

2. Where national legislation includes rules for the coordination of special schemes for civil servants and the general scheme for employed persons, those rules shall not be affected by the provisions of the Protocol and of this Annex.

### CHAPTER 5: UNEMPLOYMENT BENEFITS

#### Article SSCI.46: Aggregation of periods and calculation of benefits

1. Article SSCI.11(1) [Aggregation of periods] of this Annex shall apply *mutatis mutandis* to Article SSC.56 [Special provisions on aggregation of periods of insurance, employment or self-employment] of the Protocol. Without prejudice to the underlying obligations of the institutions involved, the person concerned may submit to the competent institution a document issued by the



institution of the State to whose legislation they were subject in respect of that person's last activity as an employed or self-employed person specifying the periods completed under that legislation.

2. For the purposes of applying Article SSC.57 [Calculation of unemployment benefits] of the Protocol, the competent institution of a State whose legislation provides that the calculation of benefits varies with the number of members of the family shall also take into account the members of the family of the person concerned residing in another State as if they resided in the competent State. This provision shall not apply where, in the State of residence of members of the family, another person is entitled to unemployment benefits calculated on the basis of the number of members of the family.

#### TITLE IV: FINANCIAL PROVISIONS

##### CHAPTER 1: REIMBURSEMENT OF THE COST OF BENEFITS IN APPLICATION OF ARTICLE SSC.30 [Reimbursements between institutions] AND ARTICLE SSC.36 [Reimbursements between institutions] OF THE PROTOCOL

###### *Section 1: Reimbursement on the basis of actual expenditure*

###### Article SSCI.47: Principles

1. For the purposes of applying Article SSC.30 [Reimbursements between institutions] and Article SSC.36 [Reimbursements between institutions] of the Protocol, the actual amount of the expenses for benefits in kind, as shown in the accounts of the institution that provided them, shall be reimbursed to that institution by the competent institution, except where Article SSCI.57 [Provisionally paid benefits in cash or contributions] of this Annex is applicable.

2. If any or part of the actual amount of the expenses for benefits referred to in paragraph 1 is not shown in the accounts of the institution that provided them, the amount to be refunded shall be determined on the basis of a lump-sum payment calculated from all the appropriate references obtained from the data available. The Specialised Committee on Social Security Coordination shall assess the bases to be used for calculation of the lump-sum payment and shall decide the amount thereof.

3. Higher rates than those applicable to the benefits in kind provided to insured persons subject to the legislation applied by the institution providing the benefits referred to in paragraph 1 may not be taken into account in the reimbursement.

###### *Section 2: Reimbursement on the basis of fixed amounts*

###### Article SSCI.48: Identification of the State(s) concerned

1. The States referred to in Article SSC.30(2) [Reimbursements between institutions] of the Protocol, whose legal or administrative structures are such that the use of reimbursement on the basis of actual expenditure is not appropriate, are listed in Appendix SSCI-3 to this Annex.

2. In the case of the States listed in Appendix SSCI-3 to this Annex, the amount of benefits in kind supplied to:

(a) family members who do not reside in the same State as the insured person, as provided for in Article SSC.15 [Residence in a State other than the competent State] of the Protocol; and to

- (b) pensioners and members of their family, as provided for in Article SSC.22(1) [No right to benefits in kind under the legislation of the State of residence], Articles SSC.23 [Pensions under the legislation of one or more States other than the State of residence, where there is a right to benefits in kind in the latter State] and SSC.24 [Residence of members of the family in a State other than the one in which the pensioner reside] of the Protocol;

shall be reimbursed by the competent institutions to the institutions providing those benefits, on the basis of a fixed amount established for each calendar year. This fixed amount shall be as close as possible to actual expenditure.

Article SSCI.49: Calculation method of the monthly fixed amounts and the total fixed amount

1. For each creditor State, the monthly fixed amount per person ( $F_i$ ) for a calendar year shall be determined by dividing the annual average cost per person ( $Y_i$ ), broken down by age group ( $i$ ), by 12 and by applying a reduction ( $X$ ) to the result in accordance with the following formula:

$$F_i = Y_i * 1/12 * (1-X)$$

Where:

- the index ( $i = 1, 2$  and  $3$ ) represents the three age groups used for calculating the fixed amounts:
- $i = 1$ : persons aged under 20,
- $i = 2$ : persons aged from 20 to 64,
- $i = 3$ : persons aged 65 and over,
- $Y_i$  represents the annual average cost per person in age group  $i$ , as defined in paragraph 2,
- the coefficient  $X$  (0.20 or 0.15) represents the reduction as defined in paragraph 3.

2. The annual average cost per person ( $Y_i$ ) in age group  $i$  shall be obtained by dividing the annual expenditure on all benefits in kind provided by the institutions of the creditor State to all persons in the age group concerned subject to its legislation and residing within its territory by the average number of persons concerned in that age group in the calendar year in question. The calculation shall be based on the expenditure under the schemes referred to in Article SSCI.20 [Regime applicable in the event of the existence of more than one regime in the State of residence or stay] of this Annex.

3. The reduction to be applied to the monthly fixed amount shall, in principle, be equal to 20% ( $X = 0.20$ ). It shall be equal to 15% ( $X = 0.15$ ) for pensioners and members of their family where the competent State is not listed in Annex SSC-3 [More rights for pensioners returning to the competent State].

4. For each debtor State, the total fixed amount for a calendar year shall be the sum of the products obtained by multiplying, in each age group  $i$ , the determined monthly fixed amounts per person by the number of months completed by the persons concerned in the creditor State in that age group.

The number of months completed by the persons concerned in the creditor State shall be the sum of the calendar months in a calendar year during which the persons concerned were, because of their residence in the territory of the creditor State, eligible to receive benefits in kind in that territory at the expense of the debtor State. Those months shall be determined from an inventory kept for that purpose by the institution of the place of residence, based on documentary evidence of the entitlement of the beneficiaries supplied by the competent institution.

5. The Specialised Committee on Social Security Coordination may present a proposal containing any amendments which may prove necessary in order to ensure that the calculation of fixed amounts comes as close as possible to the actual expenditure incurred and the reductions referred to in paragraph 3 do not result in unbalanced payments or double payments for the States.

6. The Specialised Committee on Social Security Coordination shall establish the methods for determining the elements for calculating the fixed amounts referred to in paragraphs 1 to 5.

#### Article SSCI.50: Notification of annual average costs

The annual average cost per person in each age group for a specific year shall be notified to the Specialised Committee on Social Security Coordination at the latest by the end of the second year following the year in question. If the notification is not made by this deadline, the annual average cost per person which the Specialised Committee on Social Security Coordination has last determined for a previous year will be taken.

### *Section 3 : Common provisions*

#### Article SSCI.51 : Procedure for reimbursement between institutions

1. The reimbursements between the States shall be made as promptly as possible. Every institution concerned shall be obliged to reimburse claims before the deadlines mentioned in this Section, as soon as it is in a position to do so. A dispute concerning a particular claim shall not hinder the reimbursement of another claim or other claims.

2. The reimbursements between the institutions of the Member States and the United Kingdom, provided for in Articles SSC.30 [Reimbursements between institutions] and SSC.36 [Reimbursements between institutions] of the Protocol, shall be made via the liaison body. There may be a separate liaison body for reimbursements under Article SSC.30 [Reimbursements between institutions] and Article SSC.36 [Reimbursements between institutions] of the Protocol.

#### Article SSCI.52: Deadlines for the introduction and settlement of claims

1. Claims based on actual expenditure shall be introduced to the liaison body of the debtor State within 12 months of the end of the calendar half-year during which those claims were recorded in the accounts of the creditor institution.

2. Claims of fixed amounts for a calendar year shall be introduced to the liaison body of the debtor State within the 12-month period following the month during which the average costs for the year concerned were approved by the Specialised Committee on Social Security Coordination. The inventories referred to Article SSCI.49(4) [Calculation method of the monthly fixed amounts and the total fixed amount] of this Annex shall be presented by the end of the year following the reference year.

3. In the case referred to in the second subparagraph of Article SSCI.7(5) [Provisional calculation of benefits and contributions] of this Annex, the deadline set out in paragraphs 1 and 2 of this Article shall not start before the competent institution has been identified.

4. Claims introduced after the deadlines specified in paragraphs 1 and 2 shall not be considered.

5. The claims shall be paid to the liaison body of the creditor State referred to in Article SSCI.51 [Procedure for reimbursement between institutions] of this Annex, by the debtor institution within 18 months of the end of the month during which they were introduced to the liaison body of the debtor State. This does not apply to the claims which the debtor institution has rejected for a relevant reason within that period.

6. Any disputes concerning a claim shall be settled, at the latest, within 36 months following the month in which the claim was introduced.

7. The Specialised Committee on Social Security Coordination shall facilitate the final closing of accounts in cases where a settlement cannot be reached within the period set out in paragraph 6, and, upon a reasoned request by one of the parties in the dispute, shall give its opinion on a dispute within six months following the month in which the matter was referred to it.

#### Article SSCI.53: Interest on late payments and down payments

1. From the end of the 18-month period set out in Article SSCI.52(5) [Deadlines for the introduction and settlement of claims] of this Annex, interest can be charged by the creditor institution on outstanding claims, unless the debtor institution has made, within six months of the end of the month during which the claim was introduced, a down payment of at least 90% of the total claim introduced pursuant to Article SSCI.52(1) or (2) [Deadlines for the introduction and settlement of claims] of this Annex. For those parts of the claim not covered by the down payment, interest may be charged only from the end of the 36-month period set out in Article SSCI.53(6) of this Annex.

2. The interest shall be calculated on the basis of the reference rate applied by the financial institution designated for this purpose by the Specialised Committee on Social Security Coordination to its main refinancing operations. The reference rate applicable shall be that in force on the first day of the month on which the payment is due.

3. No liaison body shall be obliged to accept a down payment as provided for in paragraph 1. If however, a liaison body declines such an offer, the creditor institution shall no longer be entitled to charge interest on late payments related to the claims in question other than under the second sentence of paragraph 1.

#### Article SSCI.54: Statement of Annual Accounts

1. The Partnership Council shall establish the claims situation for each calendar year on the basis of the Specialised Committee on Social Security Coordination's report. To this end, the liaison bodies shall notify the Specialised Committee on Social Security Coordination, by the deadlines and according to the procedures laid down by the latter, of the amount of the claims introduced, settled or contested (creditor position) and the amount of claims received, settled or contested (debtor position).

2. The Partnership Council may perform any appropriate checks on the statistical and accounting data used as the basis for drawing up the annual statement of claims provided for in

paragraph 1 in order, in particular, to ensure that they comply with the rules laid down under this Title.

## CHAPTER 2: RECOVERY OF BENEFITS PROVIDED BUT NOT DUE, RECOVERY OF PROVISIONAL PAYMENTS AND CONTRIBUTIONS, OFFSETTING AND ASSISTANCE WITH RECOVERY

### *Section 1 : Principles*

#### Article SSCI.55 : Common provisions

For the purposes of applying Article SSC.64 [Collection of contributions and recovery of benefits] of the Protocol and within the framework defined therein, the recovery of claims shall, wherever possible, be by way of offsetting either between the institutions of the Member State concerned and of the United Kingdom, or vis-à-vis the natural or legal person concerned in accordance with Articles SSCI.56 [Benefits received unduly] to SSCI.58 [Costs relating to offsetting] of this Annex. If it is not possible to recover all or any of the claim via this offsetting procedure, the remainder of the amount due shall be recovered in accordance with Articles SSCI.59 [Definitions and common provisions] to SSCI.69 [Costs related to recovery] of this Annex.

### *Section 2: Offsetting*

#### Article SSCI.56: Benefits received unduly

1. If the institution of a State has paid undue benefits to a person, that institution may, within the terms and limits laid down in the legislation it applies, request the institution of the State responsible for paying benefits to the person concerned to deduct the undue amount from arrears or on-going payments owed to the person concerned regardless of the social security branch under which the benefit is paid. The institution of the latter State shall deduct the amount concerned subject to the conditions and limits applying to this kind of offsetting procedure in accordance with the legislation it applies in the same way as if it had made the overpayments itself, and shall transfer the amount deducted to the institution that has paid undue benefits.

2. By way of derogation from paragraph 1, if, when awarding or reviewing benefits in respect of invalidity benefits, old-age and survivors' pensions pursuant to Chapter 3 [Death grants] and 4 [Invalidity benefits] of Title III [Special provisions concerning the various categories of benefits] of the Protocol, the institution of a State has paid to a person benefits of undue sum, that institution may request the institution of the State responsible for the payment of corresponding benefits to the person concerned to deduct the amount overpaid from the arrears payable to the person concerned. After the latter institution has informed the institution that has paid an undue sum of these arrears, the institution which has paid the undue sum shall within two months communicate the amount of the undue sum. If the institution which is due to pay arrears receives that communication within the deadline it shall transfer the amount deducted to the institution which has paid undue sums. If the deadline expires, that institution shall without delay pay out the arrears to the person concerned.

3. If a person has received social welfare assistance in one State during a period in which they were entitled to benefits under the legislation of another State, the body which provided the assistance may, if it is legally entitled to reclaim the benefits due to the person concerned, request the institution of any other State responsible for paying benefits in favour of the person concerned to deduct the amount of assistance paid from the amounts which that State pays to the person concerned.

This provision shall apply *mutatis mutandis* to any family member of a person concerned who has received assistance in the territory of a State during a period in which the insured person was entitled to benefits under the legislation of another State in respect of that family member.

The institution of a State which has paid an undue amount of assistance shall send a statement of the amount due to the institution of the other State, which shall then deduct the amount, subject to the conditions and limits laid down for this kind of offsetting procedure in accordance with the legislation it applies, and transfer the amount without delay to the institution that has paid the undue amount.

#### Article SSCI.57: Provisionally paid benefits in cash or contributions

1. For the purposes of applying Article SSCI.6 [Provisional application of legislation and provisional granting of benefits] of this Annex, at the latest three months after the applicable legislation has been determined or the institution responsible for paying the benefits has been identified, the institution which provisionally paid the cash benefits shall draw up a statement of the amount provisionally paid and shall send it to the institution identified as being competent.

The institution identified as being competent for paying the benefits shall deduct the amount due in respect of the provisional payment from the arrears of the corresponding benefits it owes to the person concerned and shall without delay transfer the amount deducted to the institution which provisionally paid the cash benefits.

If the amount of provisionally paid benefits exceeds the amount of arrears, or if arrears do not exist, the institution identified as being competent shall deduct this amount from ongoing payments subject to the conditions and limits applying to this kind of offsetting procedure under the legislation it applies, and without delay transfer the amount deducted to the institution which provisionally paid the cash benefits.

2. The institution which has provisionally received contributions from a legal or natural person shall not reimburse the amounts in question to the person who paid them until it has ascertained from the institution identified as being competent the sums due to it under Article SSCI.6(4) [Provisional application of legislation and provisional granting of benefits] of this Annex.

Upon request of the institution identified as being competent, which shall be made at the latest three months after the applicable legislation has been determined, the institution that has provisionally received contributions shall transfer them to the institution identified as being competent for that period for the purpose of settling the situation concerning the contributions owed by the legal or natural person to it. The contributions transferred shall be retroactively deemed as having been paid to the institution identified as being competent.

If the amount of provisionally paid contributions exceeds the amount the legal or natural person owes to the institution identified as being competent, the institution which provisionally received contributions shall reimburse the amount in excess to the legal or natural person concerned.

#### Article SSCI.58: Costs related to offsetting

No costs are payable where the debt is recovered via the offsetting procedure provided for in Articles SSCI.56 [Benefits received unduly] and SSCI.57 [Provisionally paid benefits in cash or contributions] of this Annex.

### *Section 3: Recovery*

#### Article SSCI.59: Definitions and common provisions

1. For the purposes of this Section:
  - “claim” means all claims relating to contributions or to benefits paid or provided unduly, including interest, fines, administrative penalties and all other charges and costs connected with the claim in accordance with the legislation of the State making the claim;
  - “applicant party” means, in respect of each State, any institution which makes a request for information, notification or recovery concerning a claim as defined above,
  - “requested party” means, in respect of each State, any institution to which a request for information, notification or recovery can be made.
2. Requests and any related communications between the States shall, in general, be addressed via designated institutions.
3. Practical implementation measures, including, among others, those related to Article SSCI.4 [Forms, documents and methods of exchanging data] of this Annex, and to setting a minimum threshold for the amounts for which a request for recovery can be made, shall be taken by the Specialised Committee on Social Security Coordination.

#### Article SSCI.60: Requests for information

1. At the request of the applicant party, the requested party shall provide any information which would be useful to the applicant party in the recovery of its claim.
2. In order to obtain that information, the requested party shall make use of the powers provided for under the laws, regulations or administrative practices applying to the recovery of similar claims arising in its own State. The request for information shall indicate the name, last known address, and any other relevant information relating to the identification of the legal or natural person concerned to whom the information to be provided relates and the nature and amount of the claim in respect of which the request is made.
3. The requested party shall not be obliged to supply information:
  - (a) which it would not be able to obtain for the purpose of recovering similar claims arising in its own territory;
  - (b) which would disclose any commercial, industrial or professional secrets; or
  - (c) the disclosure of which would be liable to prejudice the security of or be contrary to the public policy of a State.
4. The requested party shall inform the applicant party of the grounds for refusing a request for information.



#### Article SSCI.61: Notification

1. The requested party shall, at the request of the applicant party, and in accordance with the rules in force for the notification of similar instruments or decisions in its own territory, notify the addressee of all instruments and decisions, including those of a judicial nature, which come from the State of the applicant party and which relate to a claim or to its recovery.
2. The request for notification shall indicate the name, address and any other relevant information relating to the identification of the addressee concerned to which the applicant party normally has access, the nature and the subject of the instrument or decision to be notified and, if necessary the name, address and any other relevant information relating to the identification of the debtor and the claim to which the instrument or decision relates, and any other useful information.
3. The requested party shall without delay inform the applicant party of the action taken on its request for notification and, particularly, of the date on which the decision or instrument was forwarded to the addressee.

#### Article SSCI.62: Request for recovery

1. At the request of the applicant party, the requested party shall recover claims that are the subject of an instrument permitting enforcement issued by the applicant party to the extent permitted by and in accordance with the laws and administrative practices in force in the State of the requested party.
2. The applicant party may only make a request for recovery if:
  - (a) it also provides to the requested party an official or certified copy of the instrument permitting enforcement of the claim in the State of the applicant party, except in cases where Article SSCI.64(3) [Payment arrangements and deadline] of this Annex;
  - (b) the claim or instrument permitting its enforcement are not contested in its own State;
  - (c) it has, in its own State, applied appropriate recovery procedures available to it on the basis of the instrument referred to in paragraph 1, and the measures taken will not result in the payment in full of the claim;
  - (d) the period of limitation according to its own legislation has not expired.
3. The request for recovery shall indicate:
  - (a) the name, address and any other relevant information relating to the identification of the natural or legal person concerned or to the identification of any third party holding that person's assets;
  - (b) the name, address and any other relevant information relating to the identification of the applicant party
  - (c) a reference to the instrument permitting its enforcement, issued in the State of the applicant party
  - (d) the nature and amount of the claim, including the principal, interest, fines, administrative penalties and all other charges and costs due indicated in the currencies of the State(s) of the applicant and requested parties



- (e) the date of notification of the instrument to the addressee by the applicant party or by the requested party
  - (f) the date from which and the period during which enforcement is possible under the laws in force in the State of the applicant party
  - (g) any other relevant information.
4. The request for recovery shall also contain a declaration by the applicant party confirming that the conditions laid down in paragraph 2 have been fulfilled.
  5. The applicant party shall forward to the requested party any relevant information relating to the matter which gave rise to the request for recovery, as soon as this comes to its knowledge.

#### Article SSCI.63: Instrument permitting enforcement of recovery

1. In accordance with Article SSC.64(2) [Collection of contributions and recovery of benefits] of the Protocol, the instrument permitting enforcement of the claim shall be directly recognised and treated automatically as an instrument permitting the enforcement of a claim of the State of the requested party
2. Notwithstanding paragraph 1, the instrument permitting enforcement of the claim may, where appropriate and in accordance with the provisions in force in the State of the requested party, be accepted as, recognised as, supplemented with, or replaced by an instrument authorising enforcement in the territory of that State.

Within three months of the date of receipt of the request for recovery, the State(s) shall endeavour to complete the acceptance, recognition, supplementing or replacement, except in cases where the third subparagraph of this paragraph applies. States may not refuse to complete these actions where the instrument permitting enforcement is properly drawn up. The requested party shall inform the applicant party of the grounds for exceeding the three-month period.

If any of these actions should give rise to a dispute in connection with the claim or the instrument permitting enforcement issued by the applicant party, Article SSCI.65 [Contestation concerning the claim or the instrument permitting enforcement of its recovery and contestation concerning enforcement measures] of this Annex shall apply.

#### Article SSCI.64: Payment arrangements and deadline

1. Claims shall be recovered in the currency of the State of the requested party. The entire amount of the claim that is recovered by the requested party shall be remitted by the requested party to the applicant party.
2. The requested party may, where the laws, regulations or administrative provisions in force in its own State so permit, and after consulting the applicant party, allow the debtor time to pay or authorise payment by instalment. Any interest charged by the requested party in respect of such extra time to pay shall also be remitted to the applicant party.
3. From the date on which the instrument permitting enforcement of the recovery of the claim has been directly recognised in accordance with Article SSCI.63(1) [Instrument permitting enforcement of recovery] of this Annex, or accepted, recognised, supplemented or replaced in accordance with Article SSCI.63(2) [Instrument permitting enforcement of recovery] of this Annex to the Protocol, interest shall be charged for late payment under the laws, regulations and

administrative provisions in force in the State of the requested party and shall also be remitted to the applicant party.

Article SSCI.65: Contestation concerning the claim or the instrument permitting enforcement of its recovery and contestation concerning enforcement measures

1. If, in the course of the recovery procedure, the claim or the instrument permitting its enforcement issued in the State of the applicant party are contested by an interested party, the action shall be brought by this party before the appropriate authorities of the State of the applicant party, in accordance with the laws in force in that State. The applicant party shall without delay notify the requested party of this action. The interested party may also inform the requested party of the action.

2. As soon as the requested party has received the notification or information referred to in paragraph 1 either from the applicant party or from the interested party, it shall suspend the enforcement procedure pending the decision of the appropriate authority in the matter, unless the applicant party requests otherwise in accordance with the second subparagraph of this paragraph. Should the requested party deem it necessary, and without prejudice to Article SSCI.68 [Precautionary measures] of this Annex, it may take precautionary measures to guarantee recovery insofar as the laws or regulations in force in its own State allow such action for similar claims.

Notwithstanding the first subparagraph, the applicant party may, in accordance with the laws, regulations and administrative practices in force in its own State, request the requested party to recover a contested claim, insofar as the relevant laws, regulations and administrative practices in force in the requested party's State allow such action. If the result of the contestation is subsequently favourable to the debtor, the applicant party shall be liable for the reimbursement of any sums recovered, together with any compensation due, in accordance with the legislation in force in the requested party's State.

3. Where the contestation concerns enforcement measures taken in the State of the requested party, the action shall be brought before the appropriate authority of that State in accordance with its laws and regulations.

4. Where the appropriate authority before which the action is brought in accordance with paragraph 1 is a judicial or administrative tribunal, the decision of that tribunal, insofar as it is favourable to the applicant party and permits recovery of the claim in the State of the applicant party, shall constitute the 'instrument permitting enforcement' within the meaning of Articles SSCI.62 [Request for recovery] and SSCI.63 [Instrument permitting enforcement of recovery] of the Annex and the recovery of the claim shall proceed on the basis of that decision.

Article SSCI.66: Limits applying to assistance

1. The requested party shall not be obliged:
  - (a) to grant the assistance provided for in Articles SSCI.62 [Request for recovery] to SSCI.65 [Contestation concerning the claim or the instrument permitting enforcement of its recovery and contestation concerning enforcement measures] of this Annex, if recovery of the claim would, because of the situation of the debtor, create serious economic or social difficulties in the State of the requested party, insofar as the laws, regulations or administrative practices in force in the State of the requested party allow such action for similar national claims;

(b) to grant the assistance provided for in Articles SSCI.60 [Request for information] to SSCI.65 [Contestation concerning the claim or the instrument permitting enforcement of its recovery and contestation concerning enforcement measures] of this Annex, if the initial request under Articles SSCI.60 [Request for information] to SSCI.62 [Request for recovery] of this Annex applies to claims more than five years old, dating from the moment the instrument permitting the recovery was established in accordance with the laws, regulations or administrative practices in force in the State of the applicant party at the date of the request. However, if the claim or instrument is contested, the time limit begins from the moment that the State of the applicant party establishes that the claim or the enforcement order permitting recovery may no longer be contested.

2. The requested party shall inform the applicant party of the grounds for refusing a request for assistance.

#### Article SSCI.67: Periods of limitation

1. Questions concerning periods of limitation shall be governed as follows:

- (a) by the laws in force in the State of the applicant party, insofar as they concern the claim or the instrument permitting its enforcement; and
- (b) by the laws in force in the State of the requested party, insofar as they concern enforcement measures in the requested State.

Periods of limitation according to the laws in force in the State of the requested party shall start from the date of direct recognition or from the date of acceptance, recognition, supplementing or replacement in accordance with Article SSCI.63 [Instrument permitting enforcement of recovery] of this Annex.

2. Steps taken in the recovery of claims by the requested party in pursuance of a request for assistance, which, if they had been carried out by the applicant party, would have had the effect of suspending or interrupting the period of limitation according to the laws in force in the State of the applicant party, shall be deemed to have been taken in the latter, insofar as that effect is concerned.

#### Article SSCI.68: Precautionary measures

Upon reasoned request by the applicant party, the requested party shall take precautionary measures to ensure recovery of a claim insofar as the laws and regulations in force in the State of the requested party so permit.

For the purposes of implementing the first paragraph, the provisions and procedures laid down in Articles SSCI.62 [Request for recovery], SSCI.63 [Instrument permitting enforcement of recovery], SSCI.65 [Contestation concerning the claim or the instrument permitting enforcement of its recovery and contestation concerning enforcement measures] and SSCI.66 [Limits applying to assistance] of this Annex shall apply *mutatis mutandis*.

#### Article SSCI.69: Costs related to recovery

1. The requested party shall recover from the natural or legal person concerned and retain any costs linked to recovery which it incurs, in accordance with the laws and regulations of the State of the requested party that apply to similar claims.

2. Mutual assistance afforded under this Section shall, as a rule, be free of charge. However, where recovery poses a specific problem or concerns a very large amount in costs, the applicant and the requested parties may agree on reimbursement arrangements specific to the cases in question.

The State of the applicant party shall remain liable to the State of the requested party for any costs and any losses incurred as a result of actions held to be unfounded, as far as either the substance of the claim or the validity of the instrument issued by the applicant party is concerned.

## TITLE V: MISCELLANEOUS, TRANSITIONAL AND FINAL PROVISIONS

### Article SSCI.70: Medical examination and administrative checks

1. Without prejudice to other provisions, where a recipient or a claimant of benefits, or a member of that person's family, is staying or residing within the territory of a State other than that in which the debtor institution is located, the medical examination shall be carried out, at the request of that institution, by the institution of the beneficiary's place of stay or residence in accordance with the procedures laid down by the legislation applied by that institution.

The debtor institution shall inform the institution of the place of stay or residence of any special requirements, if necessary, to be followed and points to be covered by the medical examination.

2. The institution of the place of stay or residence shall forward a report to the debtor institution that requested the medical examination. This institution shall be bound by the findings of the institution of the place of stay or residence.

The debtor institution shall reserve the right to have the beneficiary examined by a doctor of its choice. However, the beneficiary may be asked to return to the State of the debtor institution only if that beneficiary is able to make the journey without prejudice to that person's health and the cost of travel and accommodation is paid for by the debtor institution.

3. Where a recipient or a claimant of benefits, or a member of that person's family, is staying or residing in the territory of a State other than that in which the debtor institution is located, the administrative check shall, at the request of the debtor institution, be performed by the institution of the beneficiary's place of stay or residence.

Paragraph 2 shall also apply in this case.

4. As an exception to the principle of free-of-charge mutual administrative cooperation in Article SSC.59(3) [Cooperation] of the Protocol, the effective amount of the expenses of the checks referred to in paragraphs 1 to 3 shall be refunded to the institution which was requested to carry them out by the debtor institution which requested them.

### Article SSCI.71: Notifications

1. The States shall notify the Specialised Committee on Social Security Coordination of the details of the bodies and entities defined in Article.SSC.1 [Definitions] of the Protocol and points (a) and (b) of Article SSCI.1(2) [Definitions] of this Annex, and of the institutions designated in accordance with this Annex.

2. The bodies specified in paragraph 1 shall be provided with an electronic identity in the form of an identification code and electronic address.

3. The Specialised Committee on Social Security Coordination shall establish the structure, content and detailed arrangements, including the common format and model, for notification of the details specified in paragraph 1.
4. For the purposes of implementing the Protocol, the United Kingdom may take part in the Electronic Exchange of Social Security Information and bear the related costs.
5. The States shall be responsible for keeping the information specified in paragraph 1 up to date.

#### Article SSCI.72: Information

The Specialised Committee on Social Security Coordination shall prepare the information needed to ensure that the parties concerned are aware of their rights and the administrative formalities required in order to assert them. This information shall, where possible, be disseminated electronically via publication online on sites accessible to the public. The Specialised Committee on Social Security Coordination shall ensure that the information is regularly updated and monitor the quality of services provided to customers.

#### Article SSCI.73: Currency conversion

For the purposes of applying the Protocol and this Annex, the exchange rate between two currencies shall be the reference rate published by the financial institution designated for this purpose by the Specialised Committee on Social Security Coordination. The date to be taken into account for determining the exchange rate shall be fixed by the Specialised Committee on Social Security Coordination.

#### Article SSCI.74: Implementing provisions

The Specialised Committee on Social Security Coordination may adopt further guidance on the implementation of the Protocol and of this Annex.

#### Article SSCI.75: Interim provisions for forms and documents

1. For an interim period, the end date of which shall be agreed by the Specialised Committee on Social Security Coordination, all forms and documents issued by the competent institutions in the format used immediately before the Protocol comes into force shall be valid for the purposes of implementing the Protocol and, where appropriate, shall continue to be used for the exchange of information between competent institutions. All such forms and documents issued before and during that interim period shall be valid until their expiry or cancellation.
2. The forms and documents valid in accordance with paragraph 1 include:
  - (a) European Health Insurance Cards issued on behalf of the United Kingdom, which shall be valid entitlement documents for the purposes of Articles SSC.17 [Stay outside the competent State], SSC.25(1) [Stay of the pensioner or the members of their family in a State other than the State of residence – stay in the competent State – authorisation for appropriate treatment outside the State of residence] and SSCI.22 [Stay in a State other than the competent State] of this Annex; and
  - (b) Portable documents which certify a person's social security situation as required to give effect to the Protocol.



APPENDIX SSCI-1: ADMINISTRATIVE ARRANGEMENTS BETWEEN TWO OR MORE STATES (REFERRED TO IN ARTICLE SSCI.8 OF THIS ANNEX)

BELGIUM — UNITED KINGDOM

The Exchange of Letters of 4 May and 14 June 1976 regarding Article 105(2) of Regulation (EEC) No 574/72 (waiving of reimbursement of the costs of administrative checks and medical examinations)

The Exchange of Letters of 18 January and 14 March 1977 regarding Article 36(3) of Regulation (EEC) No 1408/71 (arrangement for reimbursement or waiving of reimbursement of the costs of benefits in kind provided under the terms of Chapter 1 of Title III of Regulation (EEC) No 1408/71) as amended by the Exchange of Letters of 4 May and 23 July 1982 (agreement for reimbursement of costs incurred under Article 22(1)(a) of Regulation (EEC) No 1408/71)

DENMARK — UNITED KINGDOM

The Exchange of Letters of 30 March and 19 April 1977 as modified by an Exchange of Letters of 8 November 1989 and of 10 January 1990 on agreement of waiving of reimbursement of the costs of benefits in kind and administrative checks and medical examinations

ESTONIA — UNITED KINGDOM

The Arrangement finalised on 29 March 2006 between the Competent Authorities of the Republic of Estonia and of the United Kingdom under Article 36(3) and 63(3) of Regulation (EEC) No 1408/71 establishing other methods of reimbursement of the costs of benefits in kind provided under Regulation (EC) No 883/2004 by both countries with effect from 1 May 2004

FINLAND — UNITED KINGDOM

The Exchange of Letters 1 and 20 June 1995 concerning Article 36(3) and 63(3) of Regulation (EEC) No 1408/71 (reimbursement or waiving of reimbursement of the cost of benefits in kind) and Article 105(2) of Regulation (EEC) 574/72 (waiving of reimbursement of the cost of administrative checks and medical examinations)

FRANCE — UNITED KINGDOM

The Exchange of Letters of 25 March and 28 April 1997 regarding Article 105(2) of Regulation (EEC) No 574/72 (waiving of reimbursement of the costs of administrative checks and medical examinations)

The Agreement of 8 December 1998 on the specific methods of determining the amounts to be reimbursed for benefits in kind pursuant to Regulations (EEC) No 1408/71 and (EEC) No 574/72

HUNGARY — UNITED KINGDOM

The Arrangement finalised on 1 November 2005 between the Competent Authorities of the Republic of Hungary and of the United Kingdom under Article 35(3) and 41(2) of Regulation (EEC) No 883/2004 establishing other methods of reimbursement of the costs of benefits in kind provided under that Regulation by both countries with effect from 1 May 2004

#### IRELAND — UNITED KINGDOM

The Exchange of Letters of 9 July 1975 regarding Article 36(3) and 63(3) of Regulation (EEC) No 1408/71 (arrangement for reimbursement or waiving of reimbursement of the costs of benefits in kind provided under the terms of Chapter 1 or 4 of Title III of Regulation (EEC) No 1408/71) and Article 105(2) of Regulation (EEC) No 574/72 (waiving of reimbursement of the costs of administrative checks and medical examinations)

#### ITALY — UNITED KINGDOM

The Arrangement signed on 15 December 2005 between the Competent Authorities of the Italian Republic and of the United Kingdom under Article 36(3) and 63(3) of Regulation (EEC) No 1408/71 establishing other methods of reimbursement of the costs of benefits in kind provided under Regulation (EC) No 883/2004 by both countries with effect from 1 January 2005

#### LUXEMBOURG — UNITED KINGDOM

The Exchange of Letters of 18 December 1975 and 20 January 1976 regarding Article 105(2) of Regulation (EEC) No 574/72 (waiving of reimbursement of the costs entailed in administrative checks and medical examinations referred to in Article 105 of Regulation (EEC) No 574/72)

#### MALTA — UNITED KINGDOM

The Arrangement finalised on 17 January 2007 between the Competent Authorities of Malta and of the United Kingdom under Article 35(3) and 41(2) of Regulation (EEC) No 883/2004 establishing other methods of reimbursement of the costs of benefits in kind provided under that Regulation by both countries with effect from 1 May 2004

#### NETHERLANDS — UNITED KINGDOM

The second sentence of Article 3 of the Administrative Arrangement of 12 June 1956 on the implementation of the Convention of 11 August 1954.

#### PORTUGAL — UNITED KINGDOM

The Arrangement of 8 June 2004 establishing other methods of reimbursement of the costs of benefits in kind provided by both countries with effect from 1 January 2003

#### SPAIN — UNITED KINGDOM

The Agreement of 18 June 1999 on the reimbursement of costs for benefits in kind granted pursuant to the provisions of Regulations (EEC) No 1408/71 and (EEC) No 574/72

#### SWEDEN — UNITED KINGDOM

The Arrangement of 15 April 1997 concerning Article 36(3) and Article 63(3) of Regulation (EEC) No 1408/71 (reimbursement or waiving of reimbursement of the cost of benefits in kind) and Article 105(2) of Regulation (EEC) No 574/72 (waiving of refunds of the costs of administrative checks and medical examinations)



## APPENDIX SSCI-2

**Entitlement document** (Articles SSC.17 [Stay outside the competent State], SSC.25(1) [Stay of the pensioner or the members of their family in a State other than the State of residence – stay in the competent State – authorisation for appropriate treatment outside the State of residence] and SSCI.22 [Stay in a State other than the competent State])

1. Entitlement documents issued for the purposes of Articles SSC.17 [Stay outside the competent State] and SSC.25(1) [Stay of the pensioner or the members of their family in a State other than the State of residence – stay in the competent State – authorisation for appropriate treatment outside the State of residence] by the competent institutions of Member States shall comply with Decision No S2 of 12 June 2009 of the Administrative Commission concerning the technical specifications of the European Health Insurance Card.

2. Entitlement documents issued for the purposes of Articles SSC.17 [Stay outside the competent State] and SSC.25(1) [Stay of the pensioner or the members of their family in a State other than the State of residence – stay in the competent State – authorisation for appropriate treatment outside the State of residence] by the competent institutions of the United Kingdom shall contain the following data:

- (a) surname and forename of the document holder;
- (b) personal identification number of the document holder;
- (c) date of birth of the document holder;
- (d) expiry date of the document;
- (e) the code “UK” in lieu of the ISO code of the United Kingdom;
- (f) identification number and acronym of the United Kingdom institution issuing the document;
- (g) logical number of the document;
- (h) in the case of a provisional document, the date of issue and date of delivery of the document, and the signature and stamp of the United Kingdom institution.

3. The technical specifications of entitlement documents issued by the United Kingdom shall be notified without delay to the Specialised Committee on Social Security Coordination in order to facilitate the acceptance of the respective documents by institutions of the Member States providing the benefits in kind.

**HEALTHCARE REQUIRING PRIOR AGREEMENT** (Articles SSC.17 [Stay outside the competent State] and SSC.25(1) [Stay of the pensioner or the members of their family in a State other than the State of residence – stay in the competent State – authorisation for appropriate treatment outside the State of residence])

1. The benefits in kind to be provided under Articles SSC.17 [Stay outside the competent State] and SSC.25(1) [Stay of the pensioner or the members of their family in a State other than the State of

residence – stay in the competent State – authorisation for appropriate treatment outside the State of residence] of the Protocol shall include benefits provided in conjunction with chronic or existing illnesses as well as in conjunction with pregnancy and childbirth.

2. Benefits in kind, including those in conjunction with chronic or existing illnesses or in conjunction with childbirth, are not covered by these provisions when the objective of the stay in another State is to receive these treatments.

3. Any vital medical treatment which is only accessible in a specialised medical unit or by specialised staff or equipment must be subject to a prior agreement between the insured person and the unit providing the treatment in order to ensure that the treatment is available during the insured person's stay in a State other than the competent State or the one of residence.

4. A non-exhaustive list of the treatments which fulfil these criteria is the following:

- (a) kidney dialysis;
- (b) oxygen therapy;
- (c) special asthma treatment;
- (d) echocardiography in case of chronic autoimmune diseases;
- (e) chemotherapy.

APPENDIX SSCI-3

STATES CLAIMING THE REIMBURSEMENT OF THE COST OF BENEFITS IN KIND ON THE BASIS OF FIXED AMOUNTS (REFERRED TO IN ARTICLE SSCI.48(1) [Identification of the State(s) concerned] OF THIS ANNEX

IRELAND

SPAIN

CYPRUS

PORTUGAL

SWEDEN

UNITED KINGDOM

*ANNEX SSC-8: TRANSITIONAL PROVISIONS REGARDING THE APPLICATION OF ARTICLE SSC.11  
[Detached workers]*

MEMBER STATES