



Council of the  
European Union

Brussels, 27 November 2019  
(OR. en)

14495/19

---

**Interinstitutional File:**  
**2018/0148(COD)**

---

ENER 520  
ENV 954  
TRANS 554  
CONSOM 319  
CODEC 1681

**NOTE**

---

From: General Secretariat of the Council

To: Council

---

No. Cion doc.: 9185/18  
+ ADD 1

---

Subject: Proposal for a REGULATION OF THE EUROPEAN PARLIAMENT AND OF THE COUNCIL on the labelling of tyres with respect to fuel efficiency and other [] parameters, amending Regulation (EU) 2017/1369 and repealing Regulation (EC) No 1222/2009  
- Information from the Presidency

---

1. The Commission adopted the above mentioned proposal on 17 May 2018 within the broader package of measures on Low Carbon Mobility. While repealing Regulation (EC) No 1222/2009 on the labelling of tyres with respect to fuel efficiency and other essential parameters<sup>1</sup>, the objectives of this proposal are to clarify and extend the scope of the current regulatory framework.
2. Further to intense discussions at the level of the Energy Working Party, the Council reached a General Approach on 4 March 2019 (ref. to document: 6695/19).
3. Negotiations with the European Parliament started on 10 October 2019, under the Finnish Presidency.

---

<sup>1</sup> OJ L 342, 22.12.2009.

4. The second and final informal trilogue on the above proposal was held on 13 November 2019 and a provisional agreement was reached with the European Parliament on the basis of the annexed text.
5. On 22 November, the Permanent Representatives' Committee concluded its analysis of the attached compromise text with a view to agreement (pending further procedural steps for confirmation).<sup>2</sup>
6. The Presidency will inform the Council about the state of play of the file and next steps.
7. Additionally, the Presidency will recall some of the main changes that would be introduced, once the provisional agreement has been confirmed and finally adopted by the co-legislators, as follows:
  - the label design would be updated to include snow and ice grip icons, in line with international standards;
  - labels would become more visible to consumers due to new display rules;
  - the empty and lowest fuel efficiency and wet grip classes would be deleted to make the class scale clearer and easier to understand;
  - truck and bus tyres would also carry the label;
  - enforcement would be improved through tyre registration in a product database;
  - re-treaded tyres would be included within scope of the regulation and the new rules would apply to them, once a suitable testing method has been developed; and
  - further to the Commission's impact assessment and proper consultation of relevant stakeholders, provisions on mileage and abrasion could be included in the new regulatory framework, once suitable testing methods are available.

---

<sup>2</sup> Ref. document 14152/19.

Proposal for a **REGULATION OF THE EUROPEAN PARLIAMENT AND OF THE COUNCIL on the labelling of tyres with respect to fuel efficiency and other [] parameters, amending Regulation (EU) 2017/1369 and repealing Regulation (EC) No 1222/2009**

THE EUROPEAN PARLIAMENT AND THE COUNCIL OF THE EUROPEAN UNION,

Having regard to the Treaty on the Functioning of the European Union, and in particular Article 114 and Article 194(2) thereof,

Having regard to the proposal from the European Commission,

After transmission of the draft legislative act to the national parliaments,

Having regard to the opinion of the European Economic and Social Committee<sup>(3)</sup>,

Having regard to the opinion of the Committee of the Regions<sup>4</sup>,

Acting in accordance with the ordinary legislative procedure,

Whereas:

- (1) The Union is committed to building an Energy Union with a forward-looking climate policy. Fuel efficiency is a crucial element of the Union's 2030 Climate and Energy Policy Framework and is key to moderating energy demand.
- (2) The Commission has reviewed<sup>5</sup> the effectiveness of Regulation (EC) No 1222/2009 of the European Parliament and of the Council<sup>6</sup> and **has** identified the need to update its provisions to improve its effectiveness.
- (3) It is appropriate to replace Regulation (EC) No 1222/2009 by a new **[] regulation** which incorporates **the** amendments made in 2011 and modifies and enhances some of **[] the** provisions **of Regulation (EC) No 1222/2009** to clarify and update the content **of those provisions**, taking into account the technological progress for tyres over recent years.

---

<sup>3</sup> OJ C [...], [...], p. [...].

<sup>4</sup> OJ C [...], [...], p. [...].

<sup>6</sup> Regulation (EC) No 1222/2009 of the European Parliament and of the Council of 25 November 2009 on the labelling of tyres with respect to fuel efficiency and other essential parameters (OJ L 342 of 22.12.2009, p. 46).

(4) The transport sector accounts for a third of **the** Union's energy consumption. Road transport was responsible for about 22 % of the Union's total greenhouse gas emissions in 2015. Tyres, mainly because of their rolling resistance, account for ~~5~~ **20** % to ~~10~~ **30** % of **the** fuel consumption **of vehicles**. A reduction **in** the rolling resistance of tyres would therefore contribute significantly to the fuel efficiency of road transport and thus to the reduction of **greenhouse gas** emissions *and to the decarbonisation of the transport sector*.

*(4 a) In order to meet the challenge of reducing the CO<sub>2</sub> emissions of road transport, it is appropriate for Member States, in cooperation with the Commission, to provide for incentives to innovate a new technological process for fuel-efficient and safe C1, C2 and C3 tyres.*

(5) Tyres are characterised by a number of interrelated parameters **in**. Improving one parameter, such as rolling resistance, may have an adverse impact on others **parameters**, such as wet grip **performance**, while improving wet grip **performance** may have an adverse impact on external rolling noise. Tyre manufacturers should be encouraged to optimise all parameters beyond the standards already achieved.

(6) Fuel-efficient tyres can be cost-effective, since fuel savings more than compensate for the increased purchase price of the tyres resulting from the **higher** production costs **of those tyres**.

(7) Regulation (EC) No 661/2009 of the European Parliament and of the Council<sup>7</sup> lays down minimum requirements for the rolling resistance of tyres. Technological developments make it possible to **reduce the** energy losses **that are** due to tyre rolling resistance significantly beyond those minimum requirements. To reduce the environmental impact of road transport, it is therefore appropriate to update the provisions **on** tyre labelling to encourage end **users** to purchase more fuel-efficient tyres by providing **them with** updated harmonised information on that parameter.

---

<sup>7</sup> Regulation (EC) No 661/2009 of the European Parliament and of the Council of 13 July 2009 concerning type-approval requirements for the general safety of motor vehicles, their trailers and systems, components and separate technical units intended therefor (OJ L 200, 31.7.2009, p. 1).

*(7 a) Improving the labelling of tyres will enable consumers to obtain more relevant and comparable information on fuel efficiency, safety and noise and to take cost-effective and environment-friendly purchasing decisions when purchasing new tyres.*

(8) Traffic noise is a significant nuisance and has a harmful effect on health. Regulation (EC) No 661/2009 lays down minimum requirements for the external rolling noise of tyres.

Technological developments make it possible to reduce external rolling noise significantly beyond those minimum requirements. To reduce traffic noise, it is therefore appropriate to update the provisions [ ] **on** tyre labelling to encourage end[ ] users to purchase tyres with lower external rolling noise by providing **them with** harmonised information on that parameter.

(9) The provision of harmonised information on external rolling noise also facilitates the implementation of measures to limit traffic noise and contributes to increased awareness of the effect of tyres on traffic noise within the framework of Directive 2002/49/EC of the European Parliament and of the Council<sup>8</sup>.

(10) Regulation (EC) No 661/2009 **also** lays down minimum requirements for the wet grip performance of tyres. Technological developments make it possible to improve wet grip **performance** significantly beyond those requirements, and thus to reduce wet braking distances. To improve road safety, it is therefore appropriate to update the provisions [ ] **on** tyre labelling to encourage end[ ] users to purchase tyres with **higher** wet grip performance by providing **them with** harmonised information on that parameter.

---

<sup>8</sup> Directive 2002/49/EC of the European Parliament and of the Council of 25 June 2002 relating to the assessment and management of environmental noise (OJ L 189, 18.7.2002, p. 12).

- (11) In order to ensure alignment with the international framework, Regulation (EC) No 661/2009 refers to UNECE Regulation 117<sup>9</sup>, which [] **sets out** the relevant measurement methods for rolling resistance, **external rolling** noise, and wet and snow grip performance of tyres.

~~The measured technical parameters, representing the physical characteristics of a tyre, that suppliers should include in their technical documentation, and that they derive from the application of the relevant test and measurement methods referred to in this Regulation, are necessary to ensure that the relevant national authorities can perform their tasks under this Regulation in relation to checking the accuracy of the tyre label.~~

- (12) Information on the performance of tyres that are specifically designed for use in severe snow and ice conditions, should be included on the label.

Information on snow performance should be based on UNECE Regulation No 117 and the 'Alpine Symbol' pictogram contained therein should be included on the label of a tyre that satisfies the minimum snow index values set out in that Regulation.

Information on ice performance should, once the standard is formally adopted, be based on ISO standard 19447 and the ice pictogram should be included on the label of a tyre that satisfies the minimum ice grip index values set out in that standard. Until adoption of ISO standard 19447, ice performance should be assessed against reliable, accurate and reproducible methods, which take into account the generally recognised state-of-the-art. A tyre that satisfies the minimum ice performance standards should show the ice pictogram set out in Annex I.

~~In view of a possible future inclusion on the tyre label of the relative performance of tyres suitable for use in severe snow and in ice conditions, the European Commission may explore the feasibility of developing performance classes for such tyres, taking into account UNECE Regulation No 117 and the ISO 19447 for snow and ice respectively.~~

---

<sup>9</sup> OJ L 307, 23.11.2011, p. 3

- (13) The abrasion of tyres during use is a significant source of microplastics, which are harmful to the environment *and human health*, and the Commission's Communication "A European Strategy for Plastics in a Circular Economy"<sup>10</sup> therefore mentions the need to address unintentional release of microplastics from tyres, *inter alia* through information measures such as labelling and minimum requirements for tyres. **Linked to tyre abrasion is the concept of mileage, i.e. the number of kilometres a tyre will last before it needs to be replaced because of tread wear. In addition to abrasion and tread wear, the lifetime of a tyre depends on a range of factors, such as the wear resistance of the tyre, including the compound, tread pattern and structure, road conditions, maintenance, tyre pressure and driving behaviour.**
- (13a) However, a suitable testing method to measure tyre abrasion **and mileage** is not currently available. Therefore, the Commission should ~~promote~~ **mandate** the development of such a method ~~and assess the possibility to include such parameters in the scope of the present Regulation which will~~ **take** into full consideration all state-of-the-art internationally developed or proposed standards or regulations **as well as the work carried out by the industry**.
- (14) Re-treaded tyres **constitute** a substantial part of the market for heavy-duty vehicle tyres. Re-treading tyres extends their life and contributes to circular economy objectives, such as waste reduction. Applying labelling requirements to such tyres would bring substantial energy savings. However, as **a** suitable testing method to measure the performance of re-treaded tyres is not currently available, this Regulation should provide for **its** future inclusion. **give the Commission implementing powers in order to adopt uniform rules necessary to apply such requirements to re-treaded tyres**.

---

<sup>10</sup> COM(2018) 28 final

- (15) The energy label [] **provided for under** Regulation (EU) 2017/1369 of the European Parliament and of the Council<sup>11</sup>, which ranks the energy consumption of products on a scale from 'A' to 'G', is recognised by over 85 % of Union consumers *as a clear and transparent information tool* and has proven to be effective in promoting more efficient products. The tyre label should ~~continue to~~ use the same design to the extent possible, while recognising the specificities of [] tyre parameters.
- (16) The provision of comparable information on tyre parameters in the form of a standard **tyre** label is likely to influence purchasing decisions by end[] users in favour of safer, **long-lasting**, quieter and more fuel-efficient tyres. This, in turn, is likely to encourage tyre manufacturers to optimise [] **tyre** parameters, which would pave the way for **a** more sustainable consumption and production **of tyres**.
- (17) The need for greater information on tyre fuel efficiency and other parameters is relevant for all end[] users, including purchasers of replacement tyres, purchasers of tyres fitted on new vehicles, and fleet managers and transport undertakings, who cannot easily compare the parameters of different tyre brands in the absence of a labelling and harmonised testing regime. It is therefore appropriate to require [] **that all** tyres delivered with vehicles [] **are labelled**.
- (18) Currently, labels are [] required for tyres for cars (C1 tyres) and vans (C2 tyres) but not for heavy-duty vehicles (C3 tyres). C3 tyres consume more fuel and cover more kilometres per year than C1 and C2 tyres, and therefore the potential to reduce fuel consumption and **greenhouse gas** emissions from [] **heavy-duty** vehicles is significant. **Therefore, C3 tyres should be included in the scope of this Regulation.**

---

<sup>11</sup> Regulation (EU) 2017/1369 of the European Parliament and of the Council of 4 July 2017 setting a framework for energy labelling and repealing Directive 2010/30/EU (OJ L 198, 28.7.2017, p. 1).

<sup>17</sup> Regulation (EU) 2017/1369 of the European Parliament and of the Council of 4 July 2017 setting a framework for energy labelling and repealing Directive 2010/30/EU (OJ L 198, 28.7.2017, p. 1).



- (19) Including C3 tyres fully in the scope of this Regulation is also in line with Regulation 2018/956 of the European Parliament and of the Council<sup>12</sup>, with regard to the monitoring and reporting of CO<sub>2</sub> emissions from, and fuel consumption of new heavy-duty vehicles, and with Regulation .../... of the European Parliament and of the Council<sup>13</sup>, with regard to CO<sub>2</sub> emission performance standards for new heavy-duty vehicles<sup>14</sup>.
- (20) Many end users make tyre purchasing decisions without seeing the actual tyre and therefore do not see the label affixed to it. In such situations, end users should be shown the label before finalising the purchasing decision. The display of a label on tyres at the point of sale, as well as in technical promotional material, should ensure that distributors as well as potential end users receive harmonised information on the relevant tyre parameters at the time and place of the purchasing decision.
- (21) Some end users make tyre purchasing decisions before arriving at the point of sale, or purchase tyres by mail order or on the Internet. To ensure that those end users can also make an informed choice on the basis of harmonised information on, *inter alia*, tyre fuel efficiency, wet grip performance and external rolling noise, tyre labels should be displayed in all technical promotional material and visual advertisements for specific tyre types, including where such material is made available on the Internet. Where visual advertisements pertain to a tyre family, and not only to a specific tyre type only, the full tyre label does not necessarily have to be shown.
- (22) Potential end users should be provided with information explaining each component of the tyre label and its relevance. That information should be provided in all technical promotional material, for instance on suppliers' websites, but not in visual advertisements. *Technical promotional material should not be understood to include advertisements via billboards, newspapers, magazines or radio or television broadcasts.*

<sup>12</sup> Regulation 2018/956 of the European Parliament and of the Council of 28 June 2018 on the monitoring and reporting of CO<sub>2</sub> emissions from and fuel consumption of new heavy-duty vehicles (OJ L 173, 9.7.2018, p. 1).

<sup>13</sup> Regulation .../... of the European Parliament and of the Council of ... setting CO<sub>2</sub> emission performance standards for new heavy-duty vehicles and amending Regulation (EC) No 595/2009 (OJ L ...).

<sup>14</sup> Reference to be added once the proposal is adopted

**(22a) Recognising the growth of sales of tyres through internet sales platforms, rather than directly from suppliers, hosting service providers should be responsible for enabling the display of the label provided by the supplier in proximity to the price. They should inform the distributor of that obligation, but should not be responsible for the accuracy or content of the label and the product information sheet provided. The obligations imposed on providers of hosting services under this Regulation should remain limited to what is reasonable and should not amount to a general obligation to monitor the information that they store or to actively seek facts or circumstances indicating activities that are not compliant with the requirements of this Regulation. However, pursuant to Article 14(1) of Directive 2000/31/EC on electronic commerce, hosting service providers should, if they wish to benefit from the liability exemption contained in that provision, act expeditiously to remove or to disable access to information that they store at the request of recipients of their services and that does not comply with the requirements laid down in this Regulation (such as those relating to missing, incomplete or incorrect label or product information sheet) as soon as they obtain actual knowledge of such information or, as regards claims for damages, become aware of such information, for example through specific information provided by a market surveillance authority. A supplier selling directly to end users via its own website is covered by distributors' distance selling obligations.**

(23) Fuel efficiency, wet grip **performance**, external **rolling** noise and other parameters [] should be measured **in accordance**[] [] **with** reliable, accurate and reproducible methods that take into account the generally recognised state-of-the-art measurements and calculation methods. As far as possible, such methods should reflect average consumer behaviour and be robust in order to deter **both** intentional and unintentional circumvention. Tyre labels should reflect the comparative performance of **the** tyres in actual use, within the constraints [] **arising from** the need [] **for** reliable, accurate and reproducible laboratory testing, **in order** to enable end[] users to compare different tyres and [] to limit testing costs for manufacturers.

**(23a) Where they have a sufficient reason to believe that a supplier has not ensured the accuracy of the label and in order to give additional confidence to consumers, national authorities as defined in Article 3(37) of Regulation (EU) 2018/858 should check whether the classes for rolling resistance, wet grip performance and external rolling noise displayed on the label, as well as icons for other parameters, correspond to the documentation provided by the supplier based on test results and calculations. Such checks may take place during the type approval process and do not necessarily require physical testing of the tyre.**

(24) Compliance [] by suppliers, **wholesalers, dealers** and **other** distributors **with the provisions on tyre labelling** is essential in order to ensure a level playing field in the Union. Member States should therefore monitor such compliance through market surveillance and regular ex-post controls, in [] **accordance** with **Regulation (EU) 2019/1020 of the European Parliament and of the Council**<sup>15</sup>.

(25) In order to facilitate the monitoring of compliance, **to** provide a useful tool to end[] users and **to** allow alternative ways for [] **distributors** to receive product information sheets, tyres should be included in the product database established under Regulation (EU) 2017/1369. **That** Regulation [] should therefore be amended accordingly.

(26) Without prejudice to [] **the** market surveillance obligations **of Member States** [] **or** to [] **the** obligation[] **of suppliers** to check product conformity, suppliers should make the [] **requisite** product compliance information **electronically** available [] in the product database.

**(26a) The information relevant for consumers and distributors should be made publicly available in the public part of the product database. That information should be made available as open data so as to give mobile application developers and other comparison tools the opportunity to use it. Easy direct access to the public part of the product database should be facilitated by user-oriented tools, such as a dynamic quick response code (QR code), included on the printed label.**

---

<sup>15</sup> **Regulation (EU) 2019/1020 of the European Parliament and of the Council of 20 June 2019 on market surveillance and compliance of products and amending Directive 2004/42/EC and Regulations (EC) No 765/2008 and (EU) No 305/2011 (OJ L 169, 25.6.2019).**

**(26a) The compliance part of the product database should be subject to strict data protection rules. The required specific parts of the technical documentation in the compliance part should be made available both to market surveillance authorities and to the Commission. Where some technical information is so sensitive that it would be inappropriate to include it in the category of technical documentation as detailed in delegated acts adopted pursuant to this Regulation, market surveillance authorities should retain the power to access that information when necessary in accordance with the duty of cooperation on suppliers or by way of additional parts of the technical documentation uploaded to the product database by suppliers on a voluntary basis.**

- (27) In order for end users to have confidence in the tyre label, other labels that mimic it should not be allowed. [] **In addition,** labels, marks, symbols or inscriptions that are likely to mislead or confuse end users with respect to the parameters covered by the tyre label should not be allowed for the same reason.
- (28) The penalties applicable to infringements of this Regulation and **the implementing and** delegated acts adopted pursuant thereto should be effective, proportionate and dissuasive.
- (29) In order to promote energy efficiency, climate change mitigation, **road safety** and environmental protection, Member States should be able to create incentives for the use of energy-efficient **and safe tyres** []. Member States are free to decide on the nature of such incentives. Such incentives should comply with Union State aid rules and should not constitute unjustifiable market barriers. This Regulation does not prejudice the outcome of any future state aid procedures that may be undertaken in accordance with Articles 107 and 108 of the Treaty on the Functioning of the European Union (TFEU) in respect of such incentives.

(30) In order to amend the content and format of the **tyre** label ~~¶~~, to introduce requirements with respect to re-treaded tyres, abrasion and mileage, and to adapt the Annexes to technical progress, the power to adopt acts in accordance with Article 290 ~~¶~~ **TFEU** should be delegated to the Commission. It is of particular importance that the Commission carry out appropriate consultations during its preparatory work, including at expert level, and that those consultations be conducted in accordance with the principles laid down in the Interinstitutional Agreement on Better Law-Making of 13 April 2016<sup>16</sup>. In particular, to ensure equal participation in the preparation of delegated acts, the European Parliament and the Council should receive all documents at the same time as Member States' experts, and their experts should systematically have access to meetings of Commission expert groups dealing with the preparation of delegated acts.

~~**(30a) — In order to ensure uniform conditions for the application of this Regulation, in particular with regard to the development of a uniform methodology necessary to apply the requirements to re-treated tyres, implementing powers should be conferred on the Commission. Those powers should be exercised in accordance with Regulation (EU) No 182/2011 of the European Parliament and of the Council\*.**~~

---

~~**\* — Regulation (EU) No 182/2011 of the European Parliament and of the Council of 16 February 2011 laying down the rules and general principles concerning mechanisms for control by the Member States of the Commission's exercise of implementing powers (OJ L 55, 28.2.2011, p. 13)."**~~

**(30a) Once a reliable, accurate and reproducible method to test and measure mileage and abrasion is available, the Commission should assess the feasibility of adding information on mileage and abrasion to the tyre label. In coming forward with a delegated act to add mileage and abrasion, the Commission should take into account this assessment, and should collaborate closely with industry, relevant standardisation organisations, such as CEN, UNECE or ISO, and representatives of other stakeholder interests in the development of suitable test methods.**

---

<sup>16</sup> OJ L 123, 12.5.2016, p. 1.

**Information on mileage and abrasion should be unambiguous and have no negative impact on the clear intelligibility and effectiveness of the label as a whole towards end users. *Such information would also enable consumers to make an informed choice with regard to tyres, lifetime and the unintended release of microplastics, which would help protect the environment, and at the same time allow them to estimate the operating costs of the tyres over a longer period.***

(31) Tyres which were already placed on the market before the date of application of the requirements contained in this Regulation should not need to be re-labelled.

[]

(32 a) *The size of the label should remain the same as that set out in Regulation (EC) No 1222/2009. Details on Snow Grip and Ice Grip and the QR code should be included in the label.*

(33) The Commission should carry out an evaluation of this Regulation. [] **In accordance with** paragraph 22 of the Interinstitutional Agreement [] **of 13 April 2016** on Better Law-Making [], that evaluation should be based on [] efficiency, effectiveness, relevance, coherence and [] value added and should provide the basis for impact assessments of [] **options for further action.**

(34) Since the objectives of this Regulation, namely to increase the safety and economic and environmental efficiency of road transport by providing information to end users to allow them to choose more fuel-efficient, safer and less noisy tyres, cannot be sufficiently achieved by the Member States because [] **this** requires harmonised information for end users, but can rather, by reason of **the need for** a harmonised regulatory framework and a level playing field for manufacturers [], be better achieved at Union level, the Union may adopt measures, in accordance with the principle of subsidiarity as set out in Article 5 of the Treaty on European Union. A Regulation remains the appropriate legal instrument as it imposes clear and detailed rules which preclude divergent transposition by Member States and thus ensures a higher degree of harmonisation across the Union. A harmonised regulatory framework at Union rather than at Member State level reduces costs for suppliers, ensures a level playing field and ensures the free movement of goods across the internal market. In accordance with the principle of proportionality, as set out in that Article, this Regulation does not go beyond what is necessary in order to achieve [] **that** objective[].

(35) Regulation (EC) No 1222/2009 should therefore be repealed.[]

HAVE ADOPTED THIS REGULATION:

## *Article 1*

### **Aim and subject matter**

1. The aim of this Regulation is to increase [] safety, [] **the protection of health**, and the economic and environmental efficiency of road transport, by promoting fuel-efficient, **long-lasting** and safe tyres with low noise levels.
2. This Regulation establishes a framework for the provision of harmonised information on tyre parameters through labelling **to** allow[] end[] users to make an informed choice when purchasing tyres.

## *Article 2*

### **Scope**

1. This Regulation ~~shall apply~~ applies to C1, C2 and C3 tyres **that are placed on the market**.

**Requirements for re-treaded tyres apply once a suitable testing method to measure the performance of such tyres is available in accordance with Article 12.**

**2. — []**



3. This Regulation ~~shall~~ does not apply to:
- (a) off-road professional tyres;
  - (b) tyres designed to be fitted only to vehicles ~~built or~~ registered for the first time before 1 October 1990;
  - (c) T-type temporary-use spare tyres;
  - (d) tyres whose speed rating is less than 80 km/h;
  - (e) tyres whose nominal rim diameter does not exceed 254 mm or is 635 mm or more;
  - (f) tyres fitted with additional devices to improve traction properties, such as studded tyres;
  - (g) tyres designed only to be fitted on vehicles intended exclusively for racing;
  - (ga) **second-hand tyres, unless they are imported from a third country.**

### Article 3

#### *Definitions*

For the purposes of this Regulation, the following definitions [] apply:

- (1) ‘C1, C2 and C3 tyres’ means the tyre classes defined in Article 8 of Regulation (EC) No 661/2009;
- (2) ‘re-treaded tyre’ means a used tyre reconditioned by replacing the worn tread with new material;
- (3) ‘T-type temporary-use spare tyre’ means a temporary-use spare tyre designed for use at inflation pressures higher than those established for standard and reinforced tyres;
- (3a) **'off-road professional tyres' means a special use tyre primarily used in severe off-road conditions;**

- (4) ‘label’ means a graphic diagram, either in printed or electronic form, including in the form of a sticker, which includes symbols in order to inform end-users about the performance of a tyre or batch of tyres, in relation to the parameters set out in Annex I;
- (5) ‘point of sale’ means a location where tyres are displayed or stored and **are** offered for sale [], including car show rooms [] **where** tyres **that are not fitted on vehicles are** offered for sale to end[] users [];
- (6) ‘technical promotional material’ means **printed or electronic** documentation [] **that is** produced by [] **a** supplier to supplement advertising material with at least the technical information [] **set out in** Annex V;
- (7) ‘product information sheet’ means a standard document **that** contains[] the information as set out in Annex IV, **that is** [] in **either** printed or electronic form;
- (8) ‘technical documentation’ means documentation [] **that enables** market surveillance authorities to assess the accuracy of the label and the product information sheet of a [] **tyre**, including the information [] set out in **point 2 of** Annex [] **VIIa**;
- (9) ‘product database’ means the database established under Regulation (EU) 1369/2017 [] which consists of a consumer-oriented public part, where information concerning individual [] parameters **of tyres** is accessible by electronic means, an online portal for accessibility and a compliance part, with clearly specified accessibility and security requirements;
- (10) ‘distance selling’ means the offer for sale, hire or hire purchase by mail order, catalogue, []Internet, telemarketing or by any other method by which the potential end[] users cannot be expected to see the [] **tyre** displayed;
- (11) ‘manufacturer’ means any natural or legal person who manufactures a product, or has a product designed or manufactured, and **who** places that product on the market under his name or trademark;

- (12) ‘importer’ means any natural or legal person established in the Union who places a product from a third country on the Union market;
- (13) ‘authorised representative’ means any natural or legal person established in the Union who has received a written mandate from a manufacturer to act on his behalf in relation to specified tasks;
- (14) ‘supplier’ means a manufacturer established in the Union, an authorised representative of a manufacturer who is not established in the Union, or an importer, who places a product on the Union market;
- (15) ‘distributor’ means any natural or legal person in the supply chain, other than the supplier, who makes a product available on the market;
- (16) ‘making available on the market’ means the supply of a product for distribution or use on the Union market in the course of a commercial activity, whether in return for payment or free of charge;
- (17) ‘placing on the market’ means the first making available of a product on the Union market;
- (18) ‘end-users’ means a consumer, [] fleet manager or [] road transport undertaking[] that buys or is expected to buy a tyre;
- (19) ‘parameter’ means a tyre ~~parameter as set out in Annex I~~ **characteristic that has a significant impact on the environment, road safety or health during use**, such as mileage, and abrasion, rolling resistance, wet grip **performance**, external rolling noise, snow **grip performance and** ice **grip performance**;

- (20) ‘tyre type’ means a version of a tyre [] **for** which **the technical characteristics on the label, the product information sheet and the type identifier are the same for** all units **of that version** [];
- (21) **‘verification tolerance’ means the maximum admissible deviation, as a result of interlaboratory variation, of the measurement and calculation results of the verification tests performed by, or on behalf of, market surveillance authorities, compared to the values of the declared or published parameters, reflecting deviation arising from interlaboratory variation.**
- (22 new) ‘tyre type identifier’ means the code, usually alphanumeric, which distinguishes a specific tyre type from other types with the same trade mark or the same supplier’s name;
- (23 new) ‘equivalent tyre type’ means a tyre type which has the same technical characteristics relevant for the label and the same product information sheet, but which is placed on the market by the same supplier as another tyre type with a different tyre type identifier;

#### *Article 4*

##### **Responsibilities of tyre suppliers**

1. Suppliers shall ensure that C1, C2 and C3 tyres that are placed on the market are accompanied *free of charge*:
  - (a) for each individual tyre, [] **by** a label complying with Annex II in the form of a sticker, indicating the information and class for each of the parameters set out in Annex I, and [] **by** a product information sheet as set out in Annex IV; **or**
  - (b) for each batch of one or more identical tyres, [] **by** a label complying with Annex II in printed form[], indicating the information and class for each of the parameters set out in Annex I, and [] **by** a product information sheet as set out in Annex IV.

2. **In relation to tyres sold or offered for sale by distance selling, suppliers shall ensure that the label is displayed in proximity to the price, that the product information sheet can be accessed, including, upon request from the end-user, in physical form.**

**In relation to tyres sold or offered for sale on the Internet, suppliers may make the label available for a specific tyre type in a nested display.**

**Suppliers shall ensure that any visual advertisement for a specific tyre type shows the label. If the advertisement shows the price, the label shall be displayed in proximity to the price.**

**For visual advertisements on the Internet, suppliers may make the label available in a nested display.**

3. *Deleted*

4. Suppliers shall ensure that any technical promotional material concerning a specific **tyre** type **[ ] displays the label and** meets the requirements of Annex V.
5. Suppliers shall **provide to a relevant national authority as defined in Article 3(37) of Regulation 2018/858**, the values **used to determine** the related classes and any additional performance information **that** they declare on the label **of those tyre types, in accordance with Annex I to this Regulation, as well as the label itself in accordance with Annex II to this Regulation. This information shall be submitted to the relevant national authority as per Article 5 (1) and (2) before the placing on the market of the tyre types in question, so that the authority may verify the accuracy of the label.**
6. Suppliers shall ensure the accuracy of the labels and product information sheets that they provide.

†

7. Suppliers ~~may shall~~ make technical documentation in accordance with Annex *VIIa* available to the authorities of Member States **other than those authorities indicated in paragraph 5 or to relevant ~~any~~ national accredited bodies** on request.
8. Suppliers shall cooperate with market surveillance authorities and **shall** take immediate action to remedy any case of non-compliance with the requirements set out in this Regulation, which falls under their responsibility, at their own initiative or when required to do so by market surveillance authorities.
9. Suppliers shall not provide or display other labels, marks, symbols or inscriptions that do not comply with the requirements of this Regulation, if doing so would be likely to mislead or confuse end- users with respect to the [] parameters **set out in Annex I.**
10. Suppliers shall not [] **provide** or display labels that mimic the label provided for under this Regulation.

#### *Article 5*

#### **Responsibilities of tyre suppliers in relation to the product database**

1. [] **From 1 [] ~~June~~ May 2021[]**, suppliers shall, before placing ~~a tyre~~ on the market *a tyre produced after that date*, enter [] the information set out in Annex *VIIa* [] **into the product database.**
2. [] **For** tyres **that** are *produced* ~~on the market~~ between [insert the date of entry into force of this Regulation] and 30 [] ~~May~~ April [] **2021[]**, the supplier shall, by [] ~~31~~ [] **30 November December 2021[]** **at the latest**, enter [] the information set out in Annex *VIIa* [] **into the product database.**
- 2a. *Where tyres are placed on the market before [please insert the date of entry into force of this Regulation], the supplier may enter the information set out in Annex VIIa into the product database ~~the information set out in Annex I of Regulation (EU) 2017/1369 in relation to those tyres.~~*

3. Until the information referred to in paragraphs 1 and 2 has been entered into the product database, the supplier shall make an electronic version of the technical documentation available for inspection within 10 working days of a request received from market surveillance authorities.

**3.a When data other than those specified in Annex VIIa would become necessary for either type approval authorities or market surveillance authorities for carrying out their tasks under this Regulation, they shall be able to obtain them from the supplier within 10 working days on f a request.**

4. A tyre for which changes are made that are relevant for the label or the product information sheet shall be considered to be a new tyre type. The supplier shall indicate in the database when it no longer places on the market units of a certain tyre type.

5. After the final unit of a tyre type [] has been placed on the market, the supplier shall keep the information concerning that tyre type [] in the compliance part of the product database for a period of five years.

#### *Article 6*

#### **Responsibilities of tyre distributors**

1. Distributors shall ensure that:

(a) **at the point of sale**, tyres [] bear the label in accordance with Annex II in the form of a sticker provided by the suppliers in accordance with point (a) of Article 4(1) in a clearly visible position, *legible in its entirety* **and that the product information sheet as set out in Annex IV is available, including, upon request, in physical form; or**

(b) before the sale of a tyre [] **that is part of** a batch of one or more identical tyres, the label referred to in point (b) of Article 4(1) is shown to the end- user and is clearly displayed in the immediate proximity of the tyre at the point of sale, **and that the product information sheet as set out in Annex IV is available.**

[]

2. Distributors shall ensure that any visual advertisement for a specific **tyre** type [] shows the label. ~~Distributors may make the label available in~~ **For online advertisements for a specific tyre type of, distributors may make the label available by displaying it in a nested display.**
3. Distributors shall ensure that any technical promotional material concerning a specific **tyre** type [] *displays the label and* meets the requirements of Annex V.
4. Distributors shall ensure that where tyres offered for sale are not visible to the end[] user **at the time of sale**, they provide **the** end[] users with a copy of the label before the sale.
5. Distributors shall ensure that any paper-based distance selling [] shows the label and that [] end[] users can access the product information sheet through a free access website, or **can** request a printed copy of [] **the product information** sheet.
6. Distributors **that use**[] telemarketing-based distance selling shall specifically inform end[] users of the classes of the [] parameters on the label, and **inform them** that they can access the [] label and the product information sheet through a free access website, or by requesting a printed copy.
7. In relation to tyres sold directly on the []Internet, distributors shall ensure that the label is displayed in proximity to the price and that the product information sheet can be accessed. **The size of the label shall be such that it is clearly visible and legible and shall be proportionate to the size specified in point 2.1. of Annex II.**

**Distributors may make the label available for a specific type of tyre by displaying it in a nested display.**



## *Article 7*

### **Responsibilities of vehicle suppliers and vehicle distributors**

Where end[] users intend to acquire a new vehicle, **before the sale** vehicle suppliers and vehicle distributors shall [] provide [] such end[] users with the label for the tyres offered **or fitted** with the vehicle, [] any relevant technical promotional material, **and shall ensure that the product information sheet as set out in Annex IV is available.**

## *Article 7a*

### **Obligations of internet hosting platforms**

**Where a hosting service provider as referred to in Article 14 of Directive 2000/31/EC allows the selling of tyres through its internet site, the service provider shall enable the showing of the label and the product information sheet provided by the supplier on the display mechanism and shall inform the distributor of the obligation to display them.**

## *Article 8*

### ***Testing and measurement-methods***

The information to be provided under Articles 4, 6 and 7 on the parameters indicated on the label shall be obtained **according to [] the testing [] methods** referred to in Annex I and the laboratory alignment procedure referred to in Annex VI.

## *Article 9*

### **Verification procedure**

Member States shall assess the conformity of the declared classes for each of the [] parameters [] **set out** in Annex I in accordance with the **verification** procedure set out in Annex VII.

## Article 10

### Obligations of Member States

1. Member States shall not impede the placing on the market or putting into service, within their territories, of tyres which comply with this Regulation.
  2. Member States shall not provide incentives with regard to tyres below class B with respect to either fuel efficiency or wet grip **performance** within the meaning of Annex I, Parts A and B respectively. Taxation and fiscal measures do not constitute incentives for the purposes of this Regulation.
- 2a** Without prejudice to Regulation (EU) 2019/1020, ~~W~~ where a the relevant national authority as defined in Article 3(37) of Regulation (EU) 2018/858 has sufficient reason to believe that a supplier has not ensured the accuracy of the label in accordance with Article 4(6), it shall verify that the classes and any additional performance information declared on the label correspond to the values and to the documentation submitted by the supplier, in accordance with Article 4(5).
- 2 ab.** *In accordance with Regulation (EU) 2019/1020, ~~M~~ Member States shall ensure that the national market surveillance authorities establish a system of routine and ad-hoc inspections of points of sale for the purposes of ensuring compliance with this Regulation.*
3. Member States shall lay down the rules on penalties and enforcement mechanisms applicable to infringements of this Regulation and the delegated acts adopted pursuant thereto, and shall take all measures necessary to ensure that they are implemented. The penalties provided for shall be effective, proportionate and dissuasive.
  4. Member States shall, by 1 ~~June~~ **May 2021**<sup>[1]</sup>, notify the Commission of the rules **and the measures** referred to in paragraph 3 that have not previously been notified to the Commission, and shall notify the Commission, without delay, of any subsequent amendment affecting them.

## Article 11

### Union market surveillance and control of products entering the Union market

1. [Articles 16 to 29 of Regulation (EC) No 765/2008] **or the** Regulation on compliance and enforcement proposed under COM(2017)795] shall apply to **the [] tyres** covered by this Regulation and by the relevant delegated **and implementing** acts adopted pursuant thereto.
2. The Commission shall encourage and support cooperation and the exchange of information on market surveillance relating to the labelling of [] **tyres** between [] **the** authorities of the Member States that are responsible for market surveillance or **are** in charge of the control of [] **tyres** entering the Union market, and between [] **those authorities** and the Commission, in particular by involving [] the []Administrative Cooperation for Market Surveillance[] Expert group on Tyre Labelling **more closely**.
3. Member States' general market surveillance programmes established pursuant to [Article 13 of Regulation (EC) No 765/2008] **or the** Regulation on compliance and enforcement proposed under COM(2017)795] shall include actions to ensure the effective enforcement of this Regulation.

~~**4. Member States may authorise their market surveillance authorities to reclaim from the relevant economic operator the totality of the costs of their activities with respect to instances of non-compliance.**~~

~~**The costs referred to in paragraph 1 of this Article may include the costs of carrying out testing, the costs of taking measures in accordance with Article 28(1) and (2) of Regulation (EU) 2019/1020, the costs of storage and the costs of activities relating to products that are found to be non-compliant and are subject to corrective action prior to their release for free circulation or their placing on the market.**~~

**4. Market surveillance authorities shall have the right to may recover from the supplier the costs of document inspection and physical product testing in case of non-compliance with this Regulation or the relevant implementing and delegated acts adopted pursuant thereto.**

*Article 11a*

**Committee procedure**

**1. The Commission shall be assisted by a committee. That committee shall be a committee within the meaning of Regulation (EU) No 182/2011.**

**2. Where reference is made to this paragraph, Article 5 of Regulation (EU) No 182/2011 shall apply.**

**3. Where the committee delivers no opinion, the Commission shall not adopt the draft implementing act and the third subparagraph of Article 5(4) of Regulation (EU) No 182/2011 shall apply.**

*Article 12*

**Delegated acts**

The Commission is empowered to adopt delegated acts in accordance with Article 13 in order to:

- (a) **[] amend Annex II with regard** to the content and format of the label;
- (b) *Deleted*
- (b) **amend Annexes I, parts D and E, II, IV, V, VI, VII and VIIa and VIII [] by adapting** to technical progress the values, calculation methods and requirements **[] set out therein,** **without prejudice to Article 14a.**

*By [two years after the entry into force of this Regulation], the Commission shall adopt delegated acts in accordance with Article 13 in order to supplement this Regulation by introducing new information requirements to the Annexes for re-treaded tyres, provided that a suitable and feasible method is available.*

**The Commission is also empowered to adopt delegated acts in accordance with Article 13 in order to include parameters or information requirements for mileage and abrasion, as soon as reliable, accurate and reproducible methods to test and measure mileage and abrasion are available for use by European or international standardisation organisations and provided that the following conditions are met:**

- a) a thorough impact assessment has been carried out by the Commission; and**
- b) a proper consultation of the relevant stakeholders has been conducted by the Commission.**

Where appropriate, when preparing delegated acts, the Commission shall test the design and **the** content of [] labels for ~~specific~~ [] **tyres** with representative groups of Union customers to ensure [] **that** the labels **are clearly understandable and shall publish the results.**

## Article 13

### Exercise of delegation

1. The power to adopt delegated acts is conferred on the Commission subject to the conditions laid down in this Article.
2. The power to adopt delegated acts referred to in Article 12 shall be conferred on the Commission for a period of five years from *[please insert the date of entry into force of this Regulation]*. The Commission shall draw up a report in respect of the delegation of power not later than nine months before the end of the five-year period. The delegation of power shall be tacitly extended for periods of an identical duration, unless the European Parliament or the Council opposes such extension not later than three months before the end of each period.
3. The delegation of power referred to in Article 12 may be revoked at any time by the European Parliament or by the Council. A decision to revoke shall put an end to the delegation of the power specified in that decision. It shall take effect the day following the publication of the decision in the *Official Journal of the European Union* or at a later date specified therein. It shall not affect the validity of any delegated acts already in force.
4. Before adopting a delegated act, the Commission shall consult experts designated by each Member State in accordance with the principles laid down in the Interinstitutional Agreement of 13 April 2016 on Better Law-Making.
5. As soon as it adopts a delegated act, the Commission shall notify it simultaneously to the European Parliament and to the Council.
6. A delegated act adopted pursuant to Article 12 shall enter into force only if no objection has been expressed either by the European Parliament or **by** the Council within a period of two months of notification of that act to the European Parliament and **to** the Council or if, before the expiry of that period, the European Parliament and the Council have both informed the Commission that they will not object. That period shall be extended by two months at the initiative of the European Parliament or of the Council.

## *Article 14*

### **Evaluation and report**

By 1 June 2025 ~~7~~, the Commission shall carry out an evaluation of this Regulation and present a report to the European Parliament, the Council and the European Economic and Social Committee.

That report shall assess how effectively this Regulation and the ~~implementing and~~ delegated acts adopted pursuant thereto have ~~led~~ users to choose higher-performing tyres, taking into account its impacts on business, fuel consumption, safety, greenhouse gas emissions, *consumer awareness* and market surveillance activities. It shall also assess the costs and benefits of ~~mandatory~~ independent ~~third-party~~ verification of the information provided in the label, taking also into account the experience with the broader framework provided by Regulation (EC) No 661/2009.

## *Article 14a*

### **Review clause**

~~**As soon as suitable testing methods become available, the Commission shall assess the introduction of parameters or information requirements for mileage and abrasion in this Regulation and, if appropriate, present a legislative proposal to the European Parliament and to the Council.**~~

*Article 15*

**Amendment to Regulation (EU) 2017/1369**

In Article 12(2) of Regulation (EU) 2017/1369, point (a) is replaced by the following:

[(a) to support market surveillance authorities in carrying out their tasks under this Regulation and the relevant delegated acts, including enforcement thereof, and under Regulation (EU) .../... **of the European Parliament and of the Council**\* [(]'

---

\* **Regulation (EU) .../... of the European Parliament and of the Council of ... on the labelling of tyres with respect to fuel efficiency and other parameters, amending Regulation (EU) 2017/1369 and repealing Regulation (EC) No 1222/2009 (OJ L ...).**

*Article 16*

**Repeal of Regulation (EC) No 2009/1222**

Regulation (EC) No 2009/1222 is repealed **as of 1 May June 2021.**

References to the repealed Regulation shall be construed as references to this Regulation and read in accordance with the correlation table in Annex VIII.



*Article 17*

**Entry into force**

This Regulation shall enter into force on the twentieth day following that of its publication in the *Official Journal of the European Union*.

It shall apply from 1 ~~May~~ ~~June~~ 2021~~]~~.

This Regulation shall be binding in its entirety and directly applicable in all Member States.

Done at Brussels,

For the European Parliament

The President

For the Council

The President

---

**TRILOGUE AGREED COMPROMISES ON ANNEXES**

*ANNEX I*

**Testing, gradind and measurement of tyre parameters**

**Part A: Fuel efficiency classes and rolling resistance coefficient**

The fuel efficiency class shall be determined and illustrated on the label on the basis of the rolling resistance coefficient (*RRC in N/kN*) according to the ‘A’ to ‘G E’ scale specified below and measured in accordance with Annex 6 to UNECE Regulation No 117 and its subsequent amendments and aligned according to the procedure laid down in Annex VI.

If a tyre type is approved for more than one tyre class (e.g. C1 and C2), the grading scale used to determine the fuel efficiency class of this tyre type shall be that which is applicable to the highest tyre class (e.g. C2, not C1).

<b>C1 tyres</b>		<b>C2 tyres</b>		<b>C3 2 tyres</b>	
<b>RRC in <del>kg/t</del> N/kN</b>	<b>Energy Fuel efficiency class</b>	<b>RRC in <del>kg/t</del> N/kN</b>	<b>Energy Fuel efficiency class</b>	<b>RRC in <del>kg/t</del> N/kN</b>	<b>Energy Fuel efficiency class</b>
<i>RRC ≤ 6,5</i>	<b>A</b>	<i>RRC ≤ 5,5</i>	<b>A</b>	<i>RRC ≤ 4,0</i>	<b>A</b>
<i>6,6 ≤ RRC ≤ 7,7</i>	<b>B</b>	<i>5,6 ≤ RRC ≤ 6,7</i>	<b>B</b>	<i>4,1 ≤ RRC ≤ 5,0</i>	<b>B</b>
<i>7,8 ≤ RRC ≤ 9,0</i>	<b>C</b>	<i>6,8 ≤ RRC ≤ 8,0</i>	<b>C</b>	<i>5,1 ≤ RRC ≤ 6,0</i>	<b>C</b>
<i>9,1 ≤ RRC ≤ 10,5</i>	<b>D</b>	<i>8,1 ≤ RRC ≤ 9,0</i>	<b>D</b>	<i>6,1 ≤ RRC ≤ 7,0</i>	<b>D</b>
<i>RRC ≥ 10,6</i>	<b>E</b>	<i>RRC ≥ 9,1</i>	<b>E</b>	<i>RRC ≥ 7,1</i>	<b>E</b>

**Part B: Wet grip classes**

1. The wet grip class shall be determined and illustrated on the label on the basis of the wet grip index (G) according to the ‘A’ to ‘G E’ scale specified in the table below, calculated in accordance with point 2 and measured in accordance with Annex 5 to UNECE Regulation 117.

2. Calculation of wet grip index (G)

$$G = G(T) - 0,03$$

where:

C1 Tyres		C2 Tyres		C3 Tyres	
G	Wet grip class	G	Wet grip class	G	Wet grip class
$1,55 \leq G$	A	$1,40 \leq G$	A	$1,25 \leq G$	A
$1,40 \leq G \leq 1,54$	B	$1,25 \leq G \leq 1,39$	B	$1,10 \leq G \leq 1,24$	B
$1,25 \leq G \leq 1,39$	C	$1,10 \leq G \leq 1,24$	C	$0,95 \leq G \leq 1,09$	C
$1,10 \leq G \leq 1,24$	D	$0,95 \leq G \leq 1,09$	D	$0,80 \leq G \leq 0,94$	D
$G \leq 1,09$	E	$G \leq 0,94$	E	$G \leq 0,79$	E

$G(T)$  = wet grip index of the candidate tyre as measured in one test cycle

Part C: External rolling noise classes and measured value

The external rolling noise measured value (N, in **db(A)**) shall be declared in decibels and calculated in accordance with Annex 3 to UNECE Regulation No 117.

The external rolling noise class shall be determined and illustrated on the label on the basis of the limit values (LV) set out in Part C of Annex II of Regulation (EC) No 661/2009 as follows:

$N \leq LV - 3$	$LV - 3 < N \leq LV$	$N > LV$

N in dB

External rolling noise class



$N \leq LV - 3$



$LV - 3 < N \leq LV$



$N > LV$

### Part D: Snow grip

The snow **grip** performance shall be tested in accordance with Annex 7 to UNECE Regulation No 117.

A tyre which satisfies the minimum snow **grip** index values set out in UNECE Regulation No 117 shall be classified as a snow tyre **for use in severe snow conditions** and the following icon shall be included on the label.



### Part E: Ice grip

The ice grip performance shall be tested in accordance with reliable, accurate and reproducible methods, including, where appropriate, international standards, which take into account the generally recognised state-of-the-art.

A tyre that satisfies the relevant minimum ice **grip** index values shall be classified as an ice tyre and the following pictogram shall be included on the label.



*ANNEX II*  
**Format of the label**

**1. LABELS**

1.1 ~~The following information shall~~ **to** be included in **the upper part of** the labels ~~in~~ accordance with the illustrations below.

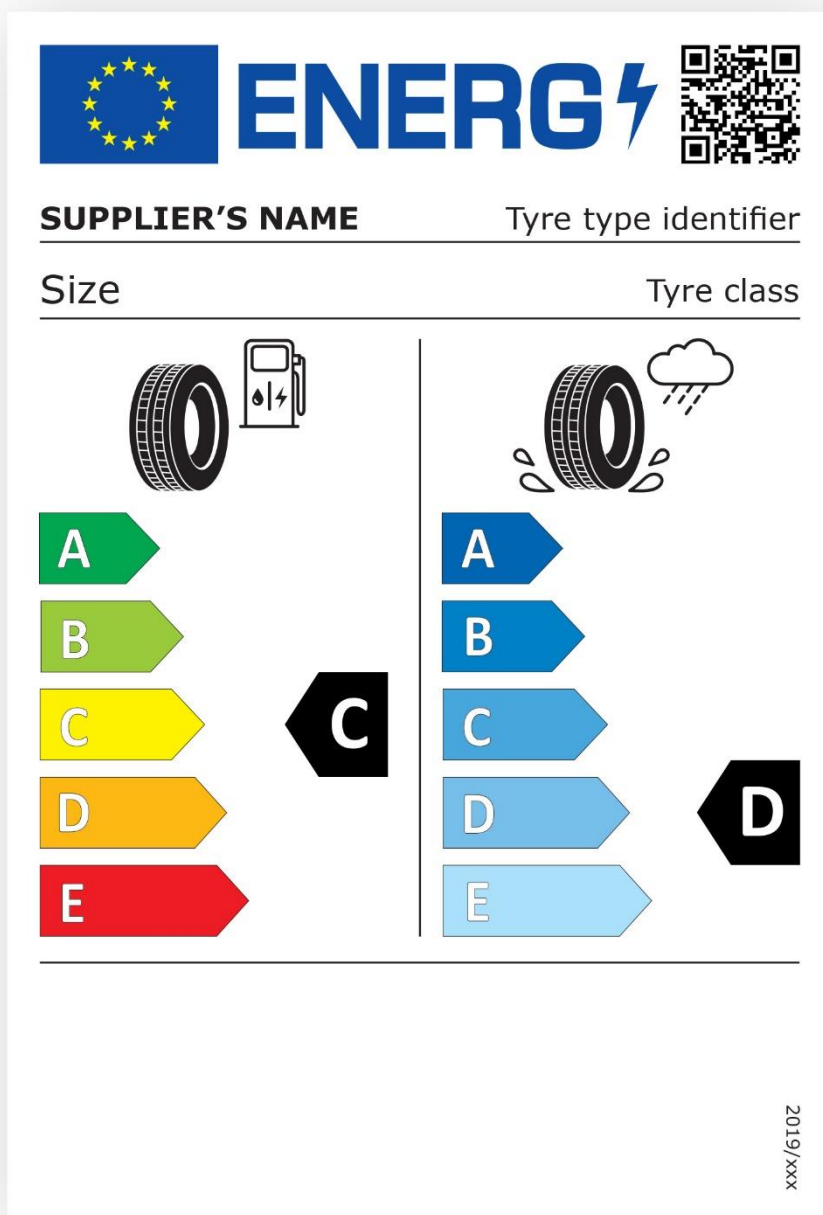

I. QR code;

- II. Trade name or trademark of the supplier;
- III. ~~Tyre model type identifier; where ‘model identifier’ means the code, usually alphanumeric, which distinguishes a specific tyre type from other type with the same trade mark or supplier’s name;~~
- IV. Tyre size designation, load-capacity index and speed category symbol, as indicated in point 2.17 of UNECE Regulation No 30 for C1 tyres or in point 2.17 of UNECE Regulation No 54 for C2 and C3 tyres;
- V. Tyre class: i.e. C1, C2 or C3;
- VI. Fuel efficiency pictogram, scale and performance class;
- VII. Wet grip pictogram, scale and performance class.

**1.2 Information to be included in the bottom part of the label for all tyres other than tyres which satisfy the minimum snow index values set out in UNECE Regulation 117, or the relevant minimum ice index values, or both.**

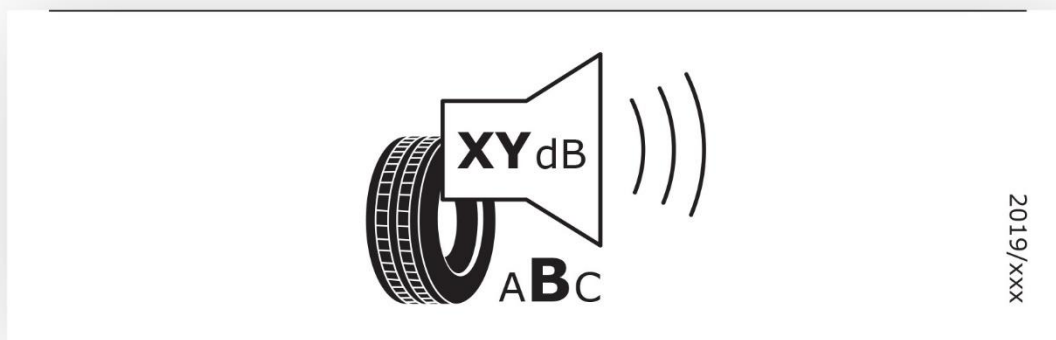

- I. External rolling noise pictogram, value (expressed in dB(A) and rounded to the nearest integer) and performance class;
- ~~VIII. Snow tyre pictogram;~~
- ~~IX. Ice tyre pictogram;~~
- II. The number of this Regulation that is ‘2020/XXX’ [*OP - please insert the number of this Regulation in this point and in the right bottom corner of the label*].

**1.3 Information to be included in the bottom part of the label for tyres which satisfy the minimum snow index values set out in UNECE Regulation 117.**

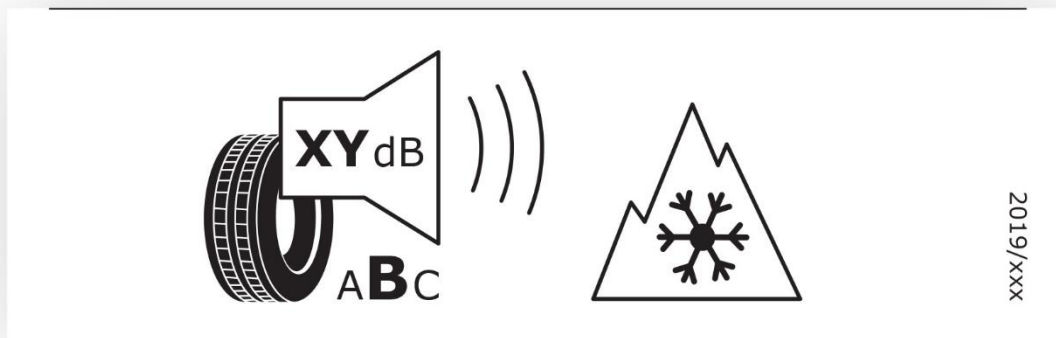

- I. External rolling noise pictogram, value (expressed in dB(A) and rounded to the nearest integer) and performance class;
- II. Snow tyre pictogram;
- III. The number of this Regulation that is '2020/XXX' [*OP - please insert the number of this Regulation in this point and in the right bottom corner of the label*].

**1.4 Information to be included in the bottom part of the label for tyres which satisfy the relevant minimum ice index values.**

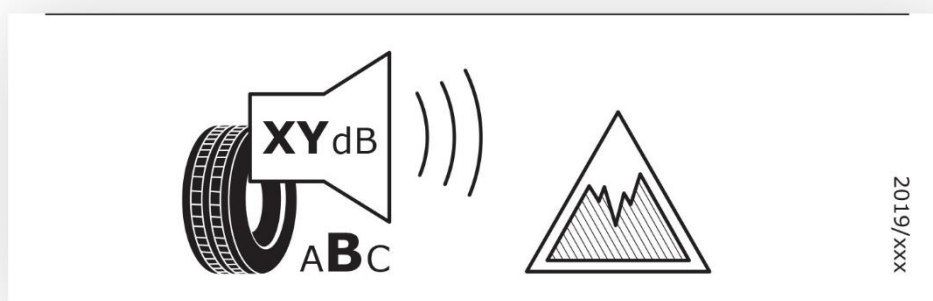

- I. External rolling noise pictogram, value (expressed in dB(A) and rounded to the nearest integer) and performance class;
- II. Ice tyre pictogram;
- III. The number of this Regulation that is '2020/XXX' [*OP - please insert the number of this Regulation in this point and in the right bottom corner of the label*].

**1.5 Information to be included in the bottom part of the label for tyres which satisfy both the relevant minimum snow index values set out in UNECE Regulation 117 and the minimum ice index values.**



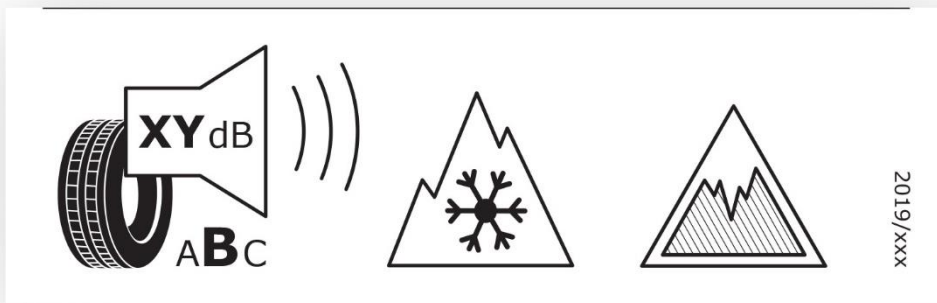

- I. External rolling noise pictogram, value (expressed in dB(A) re 1 pW and rounded to the nearest integer) and performance class;
- II. Ice tyre pictogram;
- III. The number of this Regulation that is '2020/XXX' [*OP - please insert the number of this Regulation in this point and in the right bottom corner of the label*].

## 2. LABEL DESIGN

2.1 The design of the Label design for the upper part of the labels shall be as in the figure below:

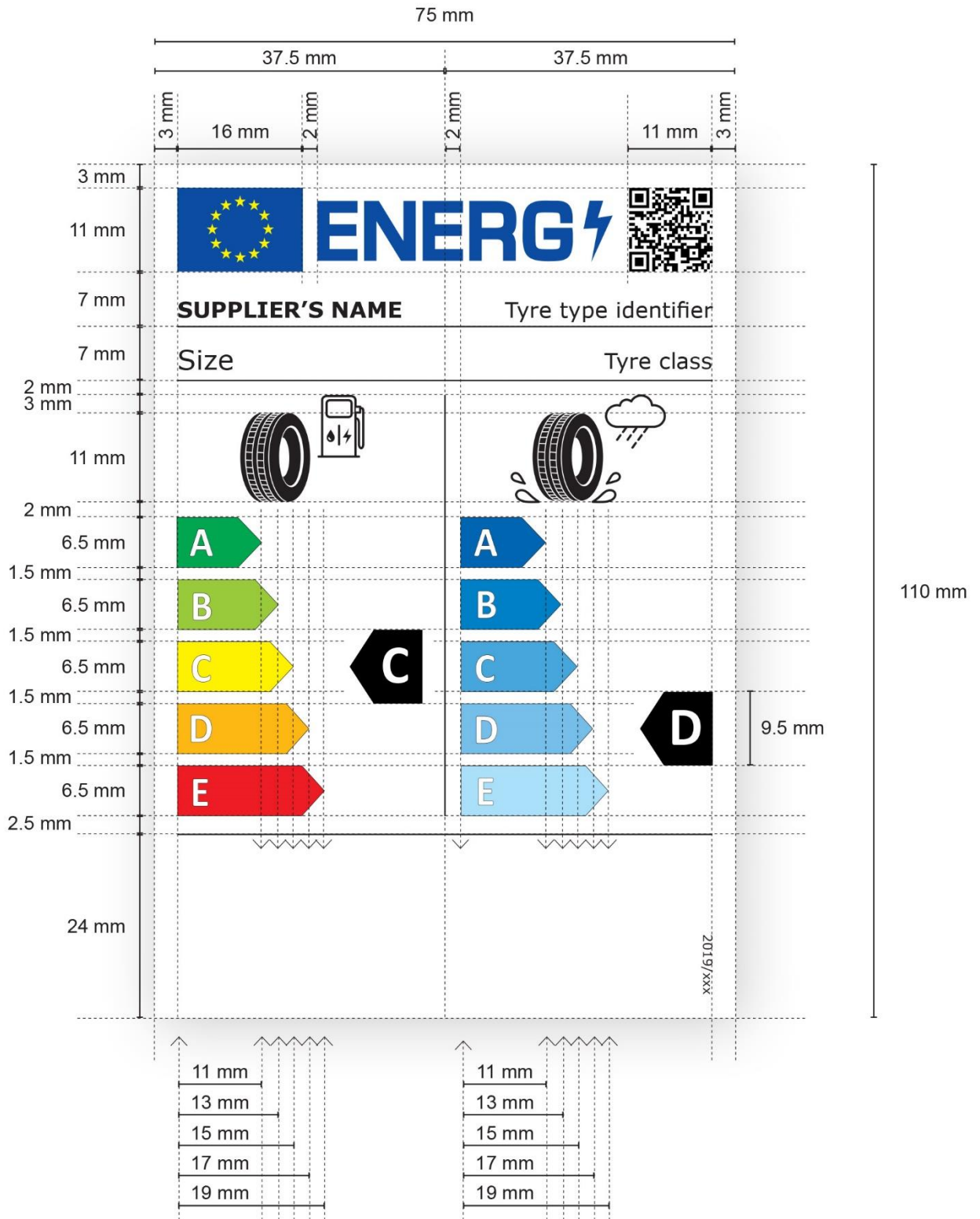

**2.1.1 Label design for the bottom part of the label for all tyres other than tyres which satisfy the minimum snow index values set out in UNECE Regulation 117, or the relevant minimum ice index values, or both.**

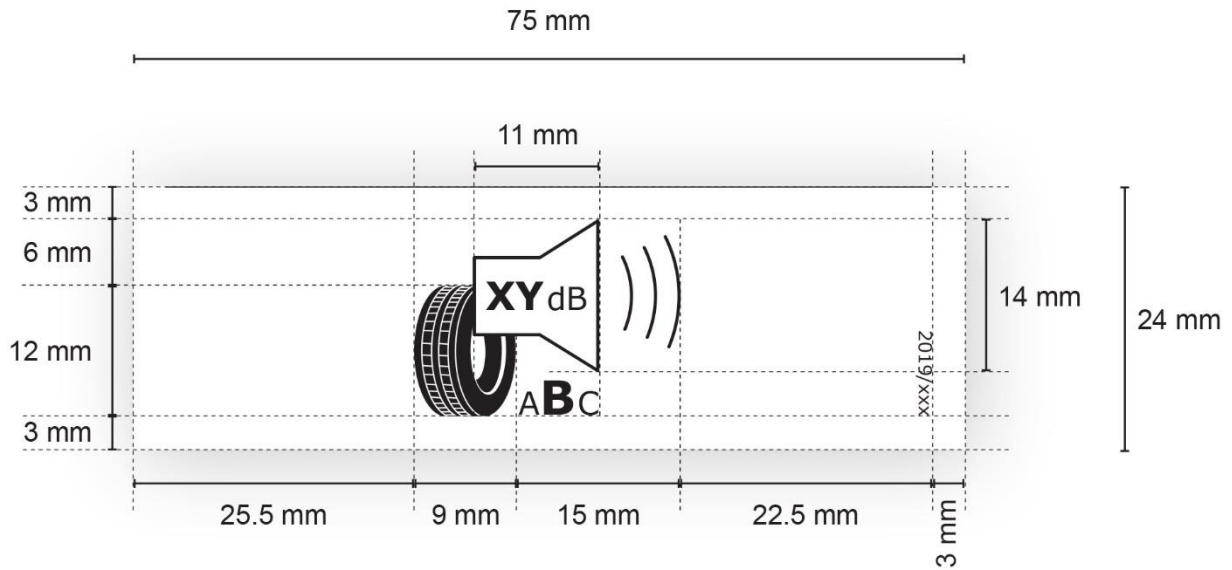

**2.1.2 Label design for the bottom part of the label for tyres which satisfy the minimum snow index values set out in UNECE Regulation 117.**

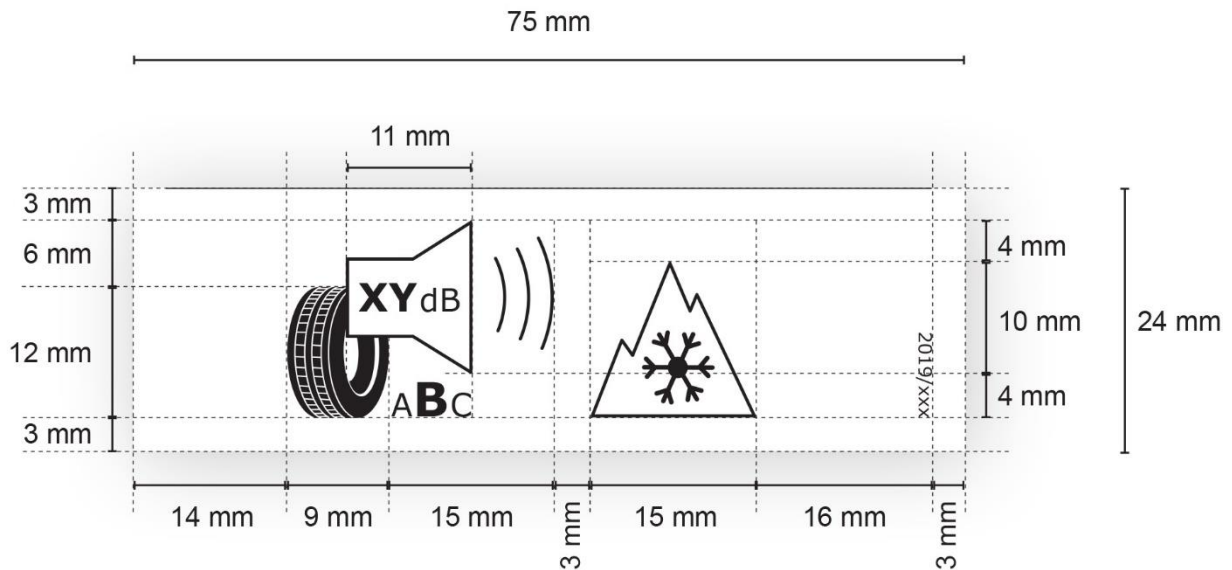

### 2.1.3 Label design for the bottom part of the label for ice tyres.

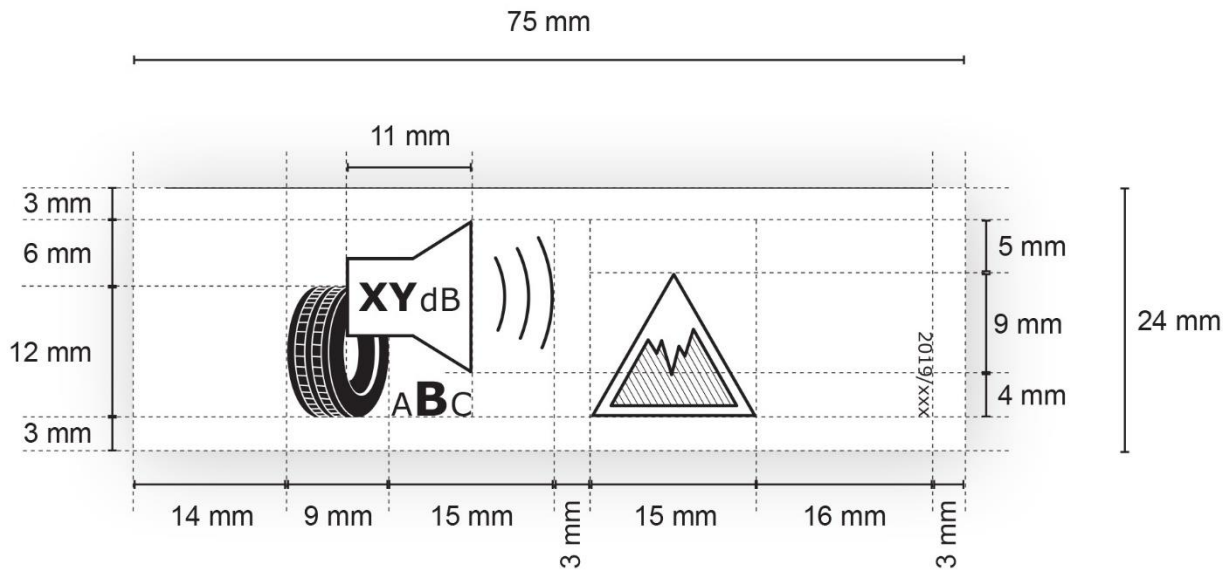

### 2.1.4 Label design for the bottom part of the label for tyres which satisfy both the relevant minimum snow index values set out in UNECE Regulation 117 and the minimum ice index values.

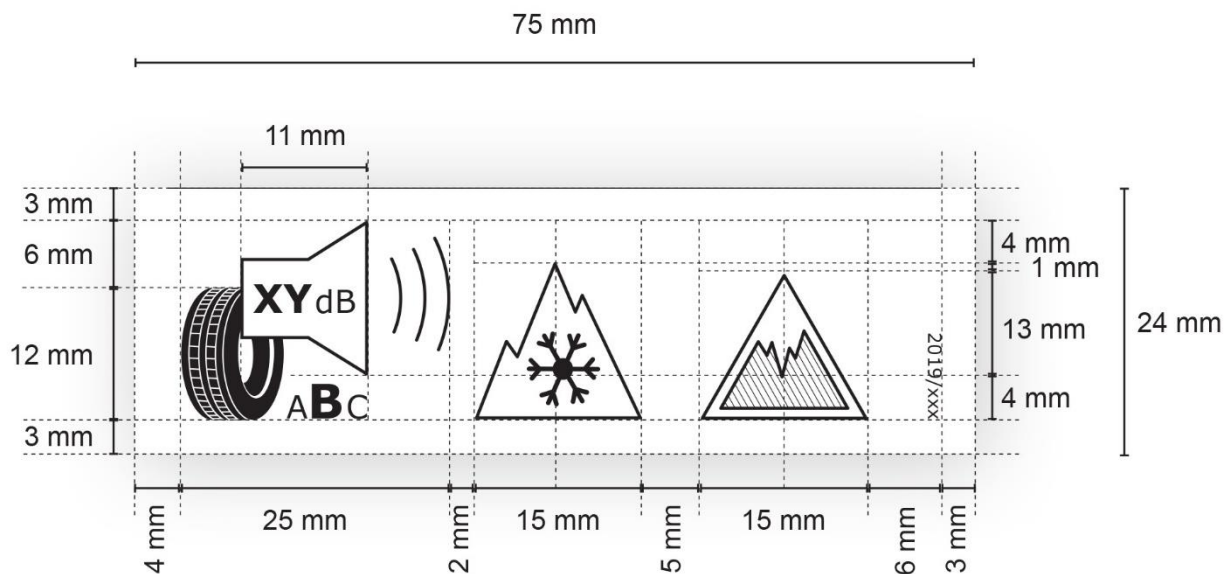

Whereby:

- (a) Label minimal size: 75 mm wide and 110 mm high. Where the label is printed in a larger format, its content shall nevertheless remain proportionate to the specifications above.
- (b) Background of the label: 100 % white.

- (c) Typefaces: Verdana and Calibri.
- (d) Dimensions and specifications of the elements constituting the label: as indicated in the label design.
- (e) Colour codes, using CMYK – cyan, magenta, yellow and black, shall fulfil all the following requirements:
- colours of the EU logo as follows:
    - background: 100,80,0,0;
    - stars: 0,0,100,0;
  - colour of the energy logo: 100,80,0,0;
  - QR code: 100 % black;
  - Supplier's name: 100 % black and in Verdana Bold 7 pt;
  - Model identifier: 100 % black and in Verdana Regular 7 pt;
  - Tyre size designation, load-capacity index and speed category symbol: 100 % black and in Verdana Regular 10 pt;
  - Tyre class: 100 % black and in Verdana Regular 7 pt, aligned to the right;
  - Letters of the energy efficiency scale and of the wet grip scale: 100 % white and in Calibri Bold 19 pt; the letters shall be centred on an axis at 4,5 mm from the left side of the arrows;
    - CMYK colour codes of arrows for the A to E fuel efficiency scale as follows:
      - A-class: 100,0,100,0;
      - B-class: 45,0,100,0;
      - C-class: 0,0,100,0;
      - D-class: 0,30,100,0;
      - E-class: 0,100,100,0;

- CMYK colour codes of arrows for the A to E wet grip scale as follows:
  - A : 100,60,0,0
  - B : 90,40,0,0
  - C : 65,20,0,0
  - D : 50,10,0,0
  - E : 30,0,0,0
- Internal dividers: weight of 0,5 pts, colour shall be 100 % black;
- Letter of the energy efficiency class: 100 % white and in Calibri Bold 33 pt. Energy efficiency and wet grip class arrows and the corresponding arrows in the A to E scale shall be positioned in such a way that their tips are aligned. The letter in the energy efficiency class and in the wet grip class arrow shall be positioned in the centre of the rectangular part of the arrow which shall be 100 % black;
- Fuel efficiency pictogram: width 16 mm, height 14 mm, weight 1 pts, colour: 100 % black
- Wet grip pictogram: width 20 mm, height 14 mm, weight 1 pts, colour: 100 % black
- External rolling noise pictogram: width 24 mm, height 18 mm, weight 1 pts, colour: 100 % black. Number of decibels in the loudspeaker in Verdana Bold 12 pt, the unit 'dB' in Regular 9 pt; the range of noise classes (A to C) centred under the pictogram, with the letter of the applicable noise class in Verdana Bold 16 pt and the other letters of the noise classes in Verdana Regular 10 pt;
- Snow pictogram: width 15 mm, height 13 mm, weight 1 pts, colour: 100 % black;
- Ice pictogram: width 15 mm, height 13 mm, weight 1 pts, weight of oblique bars 0,5 pts, colour: 100 % black;

- The number of the regulation shall be 100 % black and in Verdana Regular 6 pt.

*ANNEX III*  
**Technical documentation**

**DELETED**



*ANNEX IV*

**Product information sheet**

The information in the product information sheet of tyres shall be included in the product brochure or other literature provided with the [] tyre and shall include the following:

- a) The trade name or trade mark of the supplier, or of the manufacturer if it is not the same as the supplier;
- b) The tyre type identifier;
- c) The tyre size designation, load-capacity index and speed category symbol, as indicated in point 2.17 of UNECE Regulation No 30 for C1 tyres or in point 2.17 of UNECE Regulation No 54 for C2 and C3 tyres;**
- d) The fuel efficiency class of the tyre in accordance with Annex I;
- e) The wet grip class of the tyre in accordance with Annex I;
- f) The external rolling noise class and value in decibels in accordance with Annex I;
- g) Whether the tyre is a tyre for use in severe snow conditions;
- h) Whether the tyre is an ice tyre;
- i) The date of start of production of the tyre type (two digits for the week and two digits for the year);**
- j) The date of end of production of the tyre type, once known (two digits for the week and two digits for the year).**

*ANNEX V*

**Information provided in technical promotional material**

1. Information on tyres included in technical promotional material shall be provided in the order specified as follows:
  - (a) the fuel efficiency class (letter ‘A’ to ‘F’E’);
  - (b) the wet grip class (letter ‘A’ to ‘EG’);
  - (c) the external rolling noise class and measured value in [ ]dB;
  - (d) whether the tyre is a snow tyre;
  - (e) whether the tyre is an ice tyre.
2. The information provided in point 1 shall meet the following requirements:
  - (a) be easy to read;
  - (b) be easy to understand;
  - (c) if different grading is available for a given tyre type depending on dimension or other parameters, the range between the least and best performing tyre is stated.
3. Suppliers shall also make the following available on their websites:
  - (a) a link to the relevant Commission webpage dedicated to this Regulation;
  - (b) an explanation of the pictograms printed on the label;
  - (c) a statement highlighting the fact that actual fuel savings and road safety depend heavily on the behaviour of drivers, and in particular the following:
    - eco-driving can significantly reduce fuel consumption;
    - tyre pressure needs to be regularly checked to optimise wet grip and fuel efficiency performance;
    - stopping distances must always be strictly respected;
4. **Suppliers and distributors shall also make the following available on their websites: where relevant, a statement highlighting the fact that ice tyres are specifically designed for road surfaces covered with ice and compact snow, and should only be used in very severe climate conditions (e.g. cold temperatures) and that using ice tyres in less severe climate conditions (e.g. wet conditions or warmer temperatures) could result in sub-optimal performance, in particular for wet grip, handling and wear.**

*ANNEX VI***Laboratory alignment procedure for the measurement of rolling resistance****1. DEFINITIONS**

For the purposes of the laboratory alignment procedure **for the measurement of rolling resistance**, the following definitions [] apply:

1. ‘reference laboratory’ means a laboratory that is part of the network of laboratories, the names of which have been published [] in the *Official Journal of the European Union* **for the purpose of the laboratory alignment procedure**, and **that** is able to achieve the accuracy of test results determined in Section 3 with its reference machine;
2. ‘candidate laboratory’ means a laboratory participating in the **laboratory** alignment procedure that is not a reference laboratory;
3. ‘alignment tyre’ means a tyre that is tested for the purpose of performing the **laboratory** alignment procedure;
4. ‘alignment tyres set’ means a set of five or more alignment tyres for the alignment of one single machine;
5. ‘assigned value’ means a theoretical value of the []**rolling** []**resistance** []**coefficient** (RRC) of one alignment tyre as measured by a theoretical laboratory which is representative of the network of reference laboratories that is used for the **laboratory** alignment procedure;
6. ‘machine’ means every tyre testing spindle in one specific measurement method. For example, two spindles acting on the same drum shall not be considered as one machine.

## 2. GENERAL PROVISIONS

### 2.1. Principle

The measured ( $m$ ) rolling resistance coefficient in a reference laboratory ( $l$ ), ( $RRC_{m,l}$ ), shall be aligned to the assigned values of the network of reference laboratories.

The measured ( $m$ ) rolling resistance coefficient obtained by a machine in a candidate laboratory ( $c$ ),  $RRC_{m,c}$ , shall be aligned through one reference laboratory of the network of its choice.

### 2.2. Tyre selection requirements

A set of five or more alignment tyres shall be selected for the alignment procedure in compliance with the criteria below. One set shall be selected for C1 and C2 tyres together, and one set for C3 tyres.

- (a) The set of alignment tyres shall be selected so as to cover the range of different  $RRC_s$  of C1 and C2 tyres together, or of C3 tyres. In any event, the difference between the highest  $RRC_m$  of the tyre set, and the lowest  $RRC_m$  of the tyre set shall be, before and after alignment, at least equal to:
  - (i) 3 kg/t for C1 and C2 tyres; and
  - (ii) 2 kg/t for C3 tyres.
- (b) The  $RRC_m$  in the candidate or reference laboratories ( $RRC_{m,c}$  or  $RRC_{m,l}$ ) based on declared RRC values of each alignment tyre of the set shall be distributed evenly.
- (c) Load index values shall adequately cover the range of the tyres to be tested, ensuring that the rolling resistance force values also cover the range of the tyres to be tested.

Each alignment tyre shall be checked prior to use and **shall be** replaced when:

- (i) **the alignment tyre** shows a condition which makes it unusable for further tests; and/or
- (j) there are deviations of  $RRC_{m,c}$  or  $RRC_{m,l}$  greater than 1,5 per cent relative to earlier measurements after correction for any machine drift.

### 2.3. Measurement method

The reference laboratory shall measure each alignment tyre four times and retain the three last results for further analysis, in accordance with paragraph 4 of Annex 6 **to** UNECE Regulation No 117 and its subsequent amendments and **under** the conditions set out in paragraph 3 of Annex 6 **to** UNECE Regulation No 117 and its subsequent amendments.

The candidate laboratory shall measure each alignment tyre ( $n + 1$ ) times, with  $n$  being specified in Section 5 **of this Annex** and retain the  $n$  last results for further analysis, in accordance with paragraph 4 of Annex 6 **to** UNECE Regulation No 117 and its subsequent amendments and applying the conditions set out in paragraph 3 of Annex 6 **to** UNECE Regulation No 117 and its subsequent amendments.

Each time an alignment tyre is measured, the tyre/wheel assembly shall be removed from the machine and the entire test procedure **referred to** in paragraph 4 of Annex 6 **to** UNECE Regulation No 117 and its subsequent amendments shall be followed again from the start.

The candidate or reference laboratory shall calculate:

- (a) the measured value of each alignment tyre for each measurement as specified in **the** paragraphs 6.2 and 6.3 **of Annex 6 to** UNECE Regulation No 117 and its subsequent amendments (i.e. corrected for a temperature of 25 °C and a drum diameter of 2 m);
- (b) the mean value of the three **last measured values of each alignment tyre** (in the case of reference laboratories) or **the mean value of the  $n$  last measured values of each alignment tyre** (in the case of candidate laboratories) **and**

(c) the standard deviation ( $\sigma_m$ ) as follows:

$$\sigma_m = \sqrt{\frac{1}{p} \cdot \sum_{i=1}^p \sigma_{m,i}^2}$$

$$\sigma_{m,i} = \sqrt{\frac{1}{n-1} \cdot \sum_{j=2}^{n+1} \left( Cr_{i,j} - \frac{1}{n} \cdot \sum_{j=2}^{n+1} Cr_{i,j} \right)^2}$$

where:

i is the counter from 1 to p for the alignment tyres;

j is the counter from 2 to n+1 for the n last repetitions of each measurement of a given alignment tyre

n+1 is the number of repetitions of tyre measurements (n+1=4 for reference laboratories and n+1 ≥ 4 for candidate laboratories);

p is the number of alignment tyres (p ≥ 5).

#### 2.4. Data formats to be used for the computations and results

- The measured RRC values corrected from drum diameter and temperature shall be rounded to 2 decimal places.
- Then the computations shall be made with all digits: there shall be no further rounding except on the final alignment equations.
- All standard deviation values shall be displayed to 3 decimal places.
- All RRC values will be displayed to 2 decimal places.
- All alignment coefficients (A1<sub>l</sub>, B1<sub>l</sub>, A2<sub>c</sub> and B2<sub>c</sub>) shall be rounded and displayed to 4 decimal places.

### 3. REQUIREMENTS APPLICABLE TO THE REFERENCE LABORATORIES AND DETERMINATION OF THE ASSIGNED VALUES

The assigned values of each alignment tyre shall be determined by a network of reference laboratories. Every second year the network shall assess the stability and validity of the assigned values.

Each reference laboratory participating in the network shall comply with the specifications of Annex 6 [] to UNECE Regulation No 117 and its subsequent amendments and have a standard deviation ( $\sigma_m$ ) as follows:

- (a) not greater than 0,05 kg/t for [] C1 and C2 tyres; and
- (b) not greater than 0,05 kg/t for [] C3 tyres.

The [] alignment tyre[] sets, [] in accordance with the specification of Section 2.2, shall be measured in accordance with Section 2.3 by each reference laboratory of the network.

The assigned value of each alignment tyre is the average of the measured values given by the reference laboratories of the network for this alignment tyre.

### 4. PROCEDURE FOR THE ALIGNMENT OF A REFERENCE LABORATORY TO THE ASSIGNED VALUES

Each reference laboratory (l) shall align itself to each new set of assigned values and always after any significant machine change or any drift in machine control tyre monitoring data.

The alignment shall use a linear regression technique on all individual data. The regression coefficients,  $A_{1l}$  and  $B_{1l}$ , shall be calculated as follows:

$$RRC = A_{1l} * RRC_{m,l} + B_{1l}$$

where:

$RRC$  is the assigned value of the rolling resistance coefficient;

$RRC_{m,l}$  is the individual measured value of the rolling resistance coefficient by the reference laboratory "I" (including temperature and drum diameter corrections).

## 5. REQUIREMENTS APPLICABLE TO CANDIDATE LABORATORIES

Candidate laboratories shall repeat the alignment procedure at least once every second year for every machine and always after any significant machine change or any drift in machine control tyre monitoring data.

A common set of five different tyres, **[ ] in accordance with** the specification of Section 2.2 shall be measured in accordance with Section 2.3 firstly by the candidate laboratory and later on by one reference laboratory. More than five alignment tyres may be tested at the request of the candidate laboratory.

The alignment tyre set shall be provided by the candidate laboratory to the selected reference laboratory.

The candidate laboratory (c) shall comply with the specifications of Annex 6 **[ ] to** UNECE Regulation No 117 and its subsequent amendments and preferably have standard deviations (**[ ]  $\sigma_m$** ) as follows:

- (a) not greater than 0,075 kg/t for C1 and C2 tyres; and
- (b) not greater than 0,06 kg/t for C3 tyres.



If the standard deviation ( $\sigma_m$ ) of the candidate laboratory is higher than **[ ] those** values with four measurements, the last three ones being used for the computations, then the number  $n+1$  of measurement repetitions shall be increased as follows for the entire batch:

$$n+1 = 1 + (\sigma_m/\gamma)^2, \text{ rounded up to the nearest higher integer value}$$

where:

$$\gamma = 0,043 \text{ kg/t for [ ] C1 and C2 tyres}$$

$$\gamma = 0,035 \text{ kg/t for [ ] C3 tyres}$$

## 6. PROCEDURE FOR THE ALIGNMENT OF A CANDIDATE LABORATORY

One reference laboratory (**[ ] I**) of the network shall calculate the linear regression function on all individual data of the candidate laboratory ( $c$ ). The regression coefficients,  $A2_c$  and  $B2_c$ , shall be calculated as follows:

$$RRC_{m,l} = A2_c \times RRC_{m,c} + B2_c$$

where:

$RRC_{m,l}$  is the individual measured value of the rolling resistance coefficient by the reference laboratory (**[ ] I**) (including temperature and drum diameter corrections)

$RRC_{m,c}$  is the individual measured value of the rolling resistance coefficient by the candidate laboratory ( $c$ ) (including temperature and drum diameter corrections)

If the coefficient of determination  $R^2$  is lower than 0,97, the candidate laboratory shall not be aligned.

The aligned  $RRC$  of tyres tested by the candidate laboratory **[ ] shall be** calculated as follows:

$$RRC = (A1_l \times A2_c) \times RRC_{m,c} + (A1_l \times B2_c + B1_l)$$

*ANNEX VII***Verification procedure**

The conformity with this Regulation of the declared fuel efficiency, wet grip and external rolling noise classes, as well as the declared values, and any additional performance information on the label, shall be assessed for each tyre type or each grouping of tyres as determined by the supplier, according to one of the following procedures:

1. a single tyre or tyre set is tested first:
  - a. if the measured values meet the declared classes or external rolling noise declared value within the tolerance defined in Table 1, the test is successfully passed;
  - b. if the measured values do not meet the declared classes or external rolling noise declared value within the range defined in Table 1, three more tyres or tyre sets are tested. The average measurement value stemming from the three tyres or tyre sets tested is used to assess conformity with the declared information within the range defined in Table 1;
2. where the labelled classes or values are derived from type approval test results obtained in accordance with Regulation (EC) No 661/2009, or UNECE Regulation No 117 and its subsequent amendments, Member States may  use  measurement data obtained from **the** conformity of production tests on tyres, **carried out under the type-approval procedure established by Regulation (EU) 2018/858**.

Assessments of the measurement data obtained from the conformity of production tests shall take into account the  **verification tolerances** defined in Table 1.

Table 1

Measured parameter	Verification tolerances
Rolling resistance coefficient (fuel efficiency)	The aligned measured value shall not be greater than the upper limit (the highest <i>RRC</i> ) of the declared class by more than 0,3 kg/1 000kg.
External rolling noise	The measured value shall not be greater than the declared value of <i>N</i> by more than 1 dB(A).
Wet grip <b><u>performance</u></b>	The measured value <i>G(T)</i> shall not be lower than the lower limit (the lowest value of <i>G</i> ) of the declared class.
Snow grip <b><u>performance</u></b>	The measured value shall not be lower than the minimum snow performance index.
Ice grip <b><u>performance</u></b>	The measured value shall not be lower than the minimum ice performance index.

**Information to be entered into the product database *by the supplier***

1. Information to be entered in the public part of the database ~~by the supplier~~:

- a) the name or trademark, address, contact details and other legal identification of the supplier;
- b) the tyre type identifier ~~and the date of production~~;
- c) the label in electronic format;
- d) the ~~energy efficiency~~ class(es) and other parameters of the label;
- e) the parameters of the product information sheet in electronic format.

2. Information to be entered in the compliance part of the database ~~by the supplier~~:

- a) the tyre type identifier of all equivalent tyre types already placed on the market;
- b) a general description of the tyre type, including its dimensions, load index and speed rating, sufficient for it to be unequivocally and easily identified;
- c) protocols of the testing, grading and measurement of tyre parameters in accordance with Annex I;
- d) specific precautions, **if any**, that shall be taken when the tyre type is assembled, installed, maintained or tested;
- e) the measured technical parameters of the tyre type, **where relevant**;
- f) the calculations performed with the measured parameters;
- g) ~~testing conditions if not described sufficiently in point (e).~~

**ANNEX VIII**Correlation table<sup>17</sup>

Regulation (EC) No 1222/2009	This Regulation
Article 1(1)	Article 1(1)
Article 1(2)	Article 1(2)
Article 2(1)	Article 2(1)
Article 2(2)	Article 2(2)
Article 3(1)	Article 3(1)
Article 3(2)	Article 3(2)
-	Article 3(3)
Article 3(3)	Article 3(4)
Article 3(4)	Article 3(5)
-	Article 3(6)
Article 3(5)	Article 3(7)
-	Article 3(8)
-	Article 3(9)
Article 3(6)	Article 3(10)
Article 3(7)	Article 3(11)
Article 3(8)	Article 3(12)
Article 3(9)	Article 3(13)

<sup>17</sup> To be adapted during the lawyer-linguist phase.

Article 3(10)	Article 3(14)
Article 3(11)	Article 3(15)
-	Article 3(16)
Article 3(12)	Article 3(17)
Article 3(13)	Article 3(18)
-	Article 3(19)
Article 4	Article 4
Article 4(1)	Article 4(1)
Article 4(1)(a)	Article 4(1)(b)
Article 4(1)(b)	Article 4(1)(b)
Article 4(2)	-
-	Article 4(2)
-	Article 4(3)
Article 4(3)	Article 4(4)
Article 4(4)	Article 4(6)
-	Article 4(5)
-	Article 4(6)
-	Article 4(7)
-	Article 4(8)
-	Article 4(9)
-	Article 5

Article 5	Article 6
Article 5(1)	Article 6(1)
Article 5(1)(a)	Article 6(1)(a)
Article 5(1)(b)	Article 6(1)(b)
-	Article 6(2)
-	Article 6(3)
Article 5(2)	Article 6(4)
Article 5(3)	-
-	Article 6(5)
-	Article 6(6)
-	Article 6(7)
Article 6	Article 7
Article 7	Article 8
Article 8	Article 9
Article 9(1)	Article 10(1)
Article 9(2)	-
Article 10	Article 10(2)
Article 11	Article 12
-	Article 12(a)
-	Article 12(b)
-	Article 12(c)

Article 11(a)	-
Article 11(b)	-
Article 11(c)	Article 12(d)
Article 12	Article 11
-	Article 11(1)
-	Article 11(2)
-	Article 11(3)
-	Article 13
Article 13	-
Article 14	-
-	Article 14
Article 15	-
-	Article 15
-	Article 16
Article 16	Article 17

---